

savin

OPERATOR'S MANUAL

3685

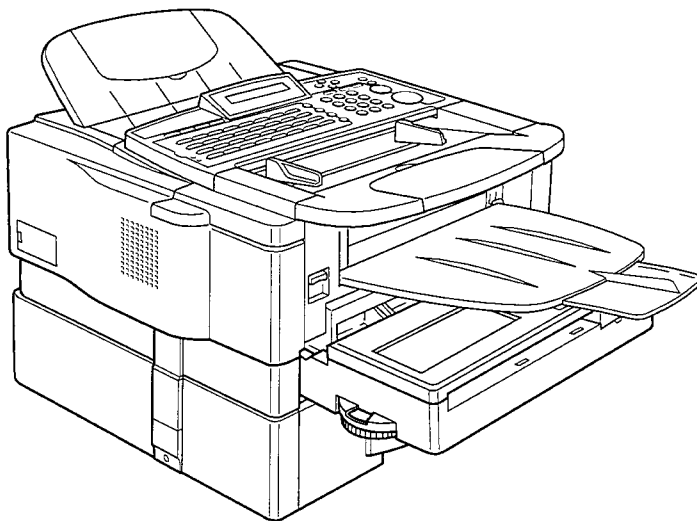

Read this manual carefully before you use this product and keep it handy for future reference. For safety, please follow the instructions in this manual.

Optional Equipment

Memory (FAX EXPANSION TYPE10, FAX EXPANSION TYPE20, FAX EXPANSION TYPE40)

Either a 1-Mbyte memory card, a 2-Mbyte memory card or a 4-Mbyte memory card can be added.

PC Printer Interface Kit (PRINTER INTERFACE TYPE 200)

This allows you to use the machine as a laser printer for an IBM¹ or compatible personal computer.

Telephone Handset (HANDSET TYPE 110)

This permits voice communication (over the PSTN).

PAPER CASSETTE TYPE 100

This gives this machine additional 100 sheet paper capacity with single sheet bypass.

PAPER FEED UNIT TYPE 140F

One extra paper feed units can be added to the base machine.

PC-FAX EXPANDER TYPE 110

This allows use of this machine as a scanner, PC Fax modem and 200dpi convenience printer.

FEATURE EXPANDER TYPE100 2M Plus Novell NEST

COUNTER TYPE 100

¹Copyright Notice

IBM is a registered trademark of International Business Machines Corporation.

IMPORTANT SAFETY INSTRUCTIONS

In addition to the warnings and cautions included in the text of this manual, please read and observe the following safety instructions.

1. Read all of these instructions.
2. Save these instructions for later use.
3. Follow all warnings and cautions marked on the product.
4. Unplug this product from the wall outlet before cleaning. Do not use liquid cleaners or aerosol cleaners. Use a damp cloth for cleaning.
5. Do not use this product near water, for example, near a bath tub, wash bowl, kitchen sink or laundry tub, in a wet basement or near a swimming pool.
6. Avoid using a telephone (other than a cordless type) during an electrical storm. There may be a remote risk of electric shock from lightning.
7. Do not use a telephone in the vicinity of a gas leak to report the leak.
8. Do not place this product on an unstable cart, stand, or table. The product may fall, causing serious damage to the product or injuring the user.
9. Slots and openings in the cabinet and the back or bottom are provided for ventilation; to ensure reliable operation of the product and to protect it from overheating, these openings must not be blocked or covered. The openings should never be blocked by placing the product on a bed, sofa, rug, or other similar surface. This product should not be placed in a built-in installation unless proper ventilation is provided.
10. This product should be operated from the type of power source indicated on the marking label. Using a different power source may result in injury or accident. If you are not sure of the type of power available, consult an authorized sales person or your local power company.
11. This product is equipped with a 3-wire grounding type plug, a plug having a third (grounding) pin. This plug will only fit into a grounding-type power outlet. This is a safety feature. If you are unable to insert the plug into the outlet, contact your electrician to replace your obsolete outlet. Do not defeat the purpose of the grounding type plug. (This does not apply in countries in which the 2-wire, non-grounded type of plug is used.)
12. Do not allow anything to rest on the power cord. Do not locate this product where persons will walk on the cord.
13. If an extension cord is used with this product, make sure that the total of the ampere ratings on the products plugged into the extension cord does not exceed the extension cord ampere rating. Also, make sure that the total of all products plugged into the wall outlet does not exceed 15 amperes.
14. Never push objects of any kind into this product through cabinet slots as they may touch dangerous voltage points or short out parts that could result in a risk of fire or electric shock. Never spill liquid of any kind on the product.
15. Do not attempt to service this product yourself, as opening or removing covers may expose you to dangerous voltage points or other risks. Refer all servicing to qualified service personnel.
16. Do not take apart or attempt any modifications to this machine. There is a risk of fire, electric shock, explosion or loss of sight.
17. Do not incinerate used toner or toner containers. Toner dust might ignite when exposed to open flame. Dispose of the used toner containers according to local regulations for plastics.

WARNING:

This equipment has been tested and found to comply with the limits for a Class A digital device, pursuant to Part 15 of the FCC Rules. These limits are designed to provide reasonable protection against harmful interference when the equipment is operated in a commercial environment. This equipment generates, uses, and can radiate radio frequency energy and, if not installed and used in accordance with the instruction manual, may cause harmful interference to radio communications. Operation of this equipment in a residential area is likely to cause harmful interference in which case the user will be required to correct the interference at his own expense.

CAUTION

Use of control or adjustments or performance of procedures other than those specified herein may result in hazardous radiation exposure.

Shielded interconnect cables must be employed with this equipment to ensure compliance with the pertinent RF emission limits governing this device.

Operator Safety

This equipment is considered a CDRH Class 1 laser device, safe for office/EDP use. The machine contains a 5-milliwatt, 760 to 800 nanometer wavelength, GaAlAs laser diode. Direct (or indirect reflected) eye contact with the laser beam may cause serious eye damage. Safety precautions and interlock mechanisms have been designed to prevent any possible laser beam exposure to the operator.

Laser Safety

The Center for Devices and Radiological Health (CDRH) prohibits the repair of laser-based optical units in the field. The optical housing unit can only be repaired in a factory or at a location with the requisite equipment. The laser subsystem is replaceable in the field by a qualified Customer Engineer. The laser chassis is not repairable in the field. Customer engineers are therefore directed to return all chassis and laser subsystems to the factory or service depot when replacement of the optical subsystem is required.

In accordance with ISO 7001, this machine uses the following symbols for the main switch:

I means POWER ON
O means POWER OFF

CAUTION

Deliver to collection point for waste products. Do not be disposed of via domestic refuse collection.

WARNING

This symbol is attached to some components to alert the user not to touch them because they may be very hot.



This symbol is intended to alert the user to the presence of important operating and maintenance (servicing) instructions in the literature accompanying the machine.

Notice about the Telephone Consumer Protection Act (Valid in USA only).

The Telephone Consumer Protection Act of 1991 among other things makes it unlawful for any person to send any message via a telephone fax machine unless such message clearly contains in a margin at the top or bottom of each transmitted page or on the first page of the transmission, the date and time it is sent and an identification of the business, other entity, or other individual sending the message and the telephone number of the sending machine or such business, other entity or individual. This information is transmitted with your document by the TTI (Transmit Terminal Identification) feature.

The telephone number provided may not be a 900 number or any other number for which charges exceed local or long distance transmission charges. In order for you to meet the requirement, your machine must be programmed by following the instructions in the accompanying Operation Manual. In particular, please refer to Appendix A: Installation. Also refer to the TTI (Transmit Terminal Identification) programming procedure to enter the business identification and telephone number of the terminal or business. Do not forget to set the date and time.

Thank you.

ENERGY SAVING INFORMATION

As an Energy Star Partner, we have determined that this fax model meets Energy Star guidelines for energy efficiency.

This product was designed to reduce the environmental impact associated with fax equipment. This is accomplished by means of energy saving features such as Low Power (saving energy) mode and Night Timer. Please see applicable sections of operating manual for details.

Table of Contents

INTRODUCTION	1
WHAT DOES A FAX MACHINE DO?	1
TELEPHONE LINE PROBLEMS AFFECT FAX COMMUNICATION.....	1
SOME OF THE THINGS THAT THIS MACHINE CAN DO.....	2
HOW TO USE THIS MANUAL	4
MANUAL OVERVIEW	4
CONVENTIONS.....	5
Keynames.....	5
Displays	5
Symbols	6
GENERAL PRECAUTIONS	7
POWER AND GROUNDING	7
COLD WEATHER POWER-UP	8
THUNDERSTORMS	8
COPY PAPER.....	9
TONER CARTRIDGES.....	9
OPERATING PRECAUTIONS.....	9
GENERAL	10
GUIDE TO COMPONENTS	11
MAIN BODY	11
OPERATION PANEL	12
ROUTINE OPERATION	15
SENDING A FAX MESSAGE	15
Precautions Concerning Unacceptable Document Types.....	15
Transmission Procedure at a Glance	17
Cancelling the Memory Transmission	25
Sending a Page with Very Fine Detail	26
Dialing with the Telephone Directory	31
Optional Features for Transmission.....	32
Sending Quickly.....	38
Changing Transmission Mode	38
Using the Stamp	40
Redialing.....	41

RECEIVING FAX MESSAGES	43
Selecting the Reception Mode.....	43
Receiving Fax Messages When There Is a Problem	44
TELEPHONE CALLS	46
Making a Telephone Call	46
Answering the Telephone	48
Phoning and Faxing on the Same Call.....	48
Speaker and Buzzer Volume Adjustments	49

ADVANCED FEATURES	50
--------------------------	-----------

TRANSMISSION	50
Transfer Request.....	50
Programming Keystrokes	55
Sending Confidential Messages.....	60
Storing an Often Used Document(Auto Document)	62
Restricting Access to the Machine.....	66
Tonal Signals	71
Dialling with the Dial Option Key	72
Storing Part of a Number.....	73
Printing Your Personal Identification at the Other End	74
Closed Network (Transmission)	75
Protection Against Wrong Connections	76
ECM(Error Correction Mode)and Page Retransmission	77
Batch Transmission	78
Well Log Transmission.....	79
RECEPTION	80
Receiving Confidential Messages	80
Locking Incoming Messages(Memory Lock)	84
Rejection of Messages from Unidentified Senders	88
Authorized Reception	89
Forwarding.....	92
Specified Cassette Selection (Optional Lower Cassette Required)	99
Wild Cards	102
Reverse Order Printing.....	103
Multi-sort Document Reception	104
Printing a Center Mark.....	107
Checked Mark	108
Reception Time.....	109
Two in One(Into 1)	110
Reducing the Page Length.....	111
Closed Network (Reception).....	112
Entering a List of Senders to Treat Differently (Function 81:Special Terminals)	113
OTHER	116
Calling to Request a Message(Polling)	116

File Management.....	123
User Function Keys	124
Printing a File.....	125
Saving Energy	126
Night Timer	128
Counters	131
Entering PC Printer Mode(Printer Interface Required).....	132
Dual Access.....	133
RDS(Remote Diagnostic System).....	134
AI Short Protocol.....	135
Copying.....	136

REPORTS

137

AUTOMATICALLY PRINTED REPORTS	137
Switching Reports On/Off	139
Printing a Sample of Data on the Reports.....	140
Report Formats.....	141
User-Initiated Reports.....	143
Descriptions of Available Reports.....	143

LOOKING AFTER THE MACHINE

146

REPLACING PAPER.....	146
REPLACING TONER CASSETE AND CLEANING PAD	147
REPLACING THE STAMP	150
CHANGING THE PAPER SIZE(OPTIONAL CASSETTE).....	151
USER MAINTENANCE PROCEDURES.....	154
Cleaning Reference Table	154
Cleaning Procedure.....	155
Cleaning the Corona Wire	159
Replacing the ADF Roller Assembly and the Separation Pad.....	161
Replacing the Photoconductor	163

SOLVING PROBLEMS

166

DOCUMENT JAMS	166
Cleaning a Document Jam	166
Adjusting the Document Feeder	167
COPY JAMS	168
Cassette Entrance	168
Copy Feed Area.....	170
Copy Jams When You Use the Optional Removable Cassette (Cassette Area).....	173
COMMUNICATION PROBLEMS	174

OPERATING DIFFICULTIES	174
DISPLAYED ERROR MESSAGES	178
ERROR CODES	179
CALLING THE SERVICE STATION	181
DEDICATED TRANSMISSION PARAMETERS	181

<i>TECNICAL REFERENCE</i>	182
----------------------------------	------------

STORING TELEPHONE NUMBERS	182
STORING NAMES AND LABELS	182
Punctuation Marks and Symbols.....	183
Editing with the Clear Key and Cursor	183
IF YOU MAKE A MISTAKE	183
ON/OFF SWITCHES AND USER PARAMETERS	184
On/Off Switches.....	184
User Parameter Settings	185
SPECIFICATIONS	190

<i>APPENDIX INSTALLATION AND INITIAL SETTINGS</i>	191
--	------------

LOCATION	191
ATTACHING THE DOCUMENT TABLE AND DOCUMENT TRAY	192
INSTALLING THE PHOTOCONDUCTOR, TONER CASSETTE AND CLEANING PAD	193
CONNECTING THE MACHINE	195
LOADING THE PAPER IN THE CASSETTE	196
INSTALLING REMOVABLE CASSETTE AND LOADING PAPER(OPTION)...	198
ATTACHING THE OPTIONAL HANDSET	201
INSTALLING THE OPTIONAL FEATURE EXPANDER	201
USING MANUAL FEED	202
Using Manual Feed with the Removable Cassette(Option)	202
SOME ITEMS MUST BE PROGRAMMED FIRST	203
Overview.....	203
Selecting the Display Language Selection	203
Setting the Date and Time	204
Summer Time / DST(Daylight Saving Time).....	204
Setting Your Machine's Identification	205
Pulse Dial or Tone Dial	208
QUICK DIAL,SPEED DIAL, AND GROUP DIAL	209
Three Convenient Ways to Dial	209
Programming Quick Dial.....	211
Programming Speed Dial	214
Programming Group Dial	217
Storage Capacity for Telephone Numbers.....	221

DEALING WITH JUNK FAX MAIL..... 222
OTHER ITEMS TO PROGRAM AT YOUR LEISURE..... 222

<i>GLOSSARY</i>	223
-----------------	-----

INTRODUCTION

Thank you for purchasing this product. This multi-function office machine offers a wide range of fax, copier, printer, and convenience features.

WHAT DOES A FAX MACHINE DO?

When you write a letter, you normally seal it in an envelope, attach a stamp, and post it in the nearest mail box. Then, in a few days, depending on the postal service, the letter will arrive at its destination. However, you may not be aware of its arrival until you get a return letter.

A fax machine speeds up this process. After you have written your letter, place it in your fax machine's document feeder or on the exposure glass, dial the destination's fax number, then press the Start key.

The fax machine scans your letter, and converts it into a series of black and white dots (the number of dots that there are across and down the page depends on the resolution that you selected; refer to the specifications section of this manual for details). This series of dots is transformed into an electrical signal and sent out over the telephone line to the destination fax machine.

The receiving fax machine reconstructs your letter from the incoming signal, and prints it.

If you are worried about whether the message arrived at the destination, you can check a report called the Journal. When you print this report, you will see the results of the most recent fax communications made by your machine.

You can use your fax machine to send and receive many types of documents, even photographs.

TELEPHONE LINE PROBLEMS AFFECT FAX COMMUNICATION

Quick and accurate transmission of fax messages depends on the condition of the telephone line. If the line condition is very good, this machine will transmit a letter-size page in about 3 seconds. However, if the line is noisy, the speed may be reduced significantly, and the data may be damaged.

The symptoms of data loss caused by a noisy telephone line are seen on the printouts of received messages. An example is shown opposite. Note that lines are missing from the page at the indicated locations. ECM (Error Correction Mode) is an effective countermeasure against this type of error; you have the choice of having the ECM feature switched on or off. It is switched on before the machine leaves the factory. (Refer to page 62 for more information about ECM).

The line condition is affected by the weather; thunderstorms can cause electrical noise on telephone lines.

In addition, the quality and condition of switching equipment used by your phone company can affect fax communication.

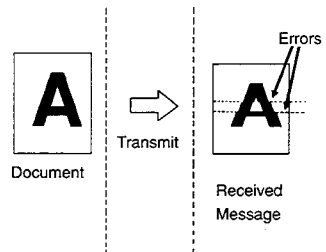

SOME OF THE THINGS THAT THIS MACHINE CAN DO.

Sending a Fax to More Than One Location

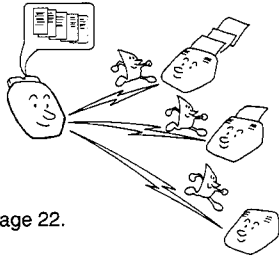

See page 22.

Network Feature (Transfer Request)

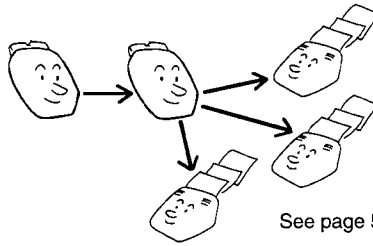

See page 50.

Restricting Access to the Machine

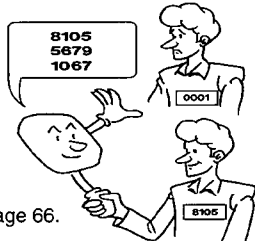

See page 66.

Quick Dial, Speed Dial, and Group Dial



See page 209.

Sending at a Specific Time

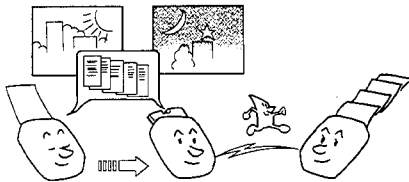

See page 34.

Confidential Communication

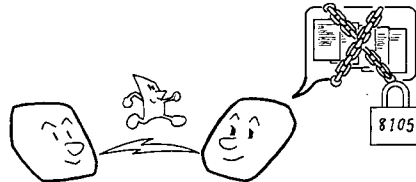

See pages 60 and 80.

Programming Keystrokes

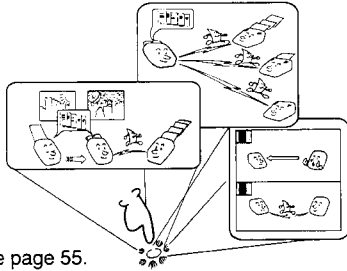

See page 55.

Auto Document (sends a commonly transmitted page with one touch)

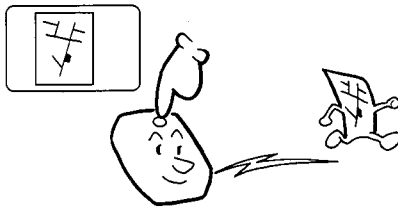

See page 62.

Authorized Reception (cuts out junk fax mail)

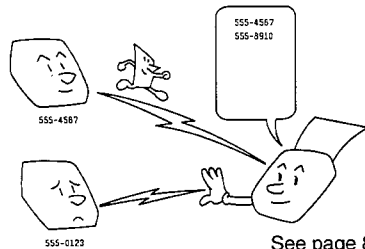

See page 89.

Forwarding

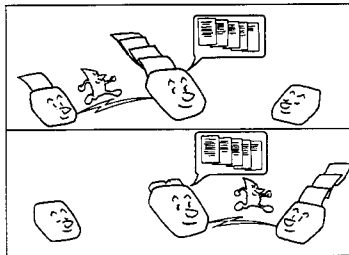

See page 92.

Batch Transmission

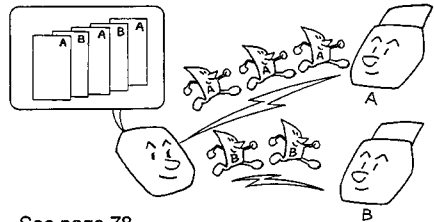

See page 78.

Sending by a Specific Time

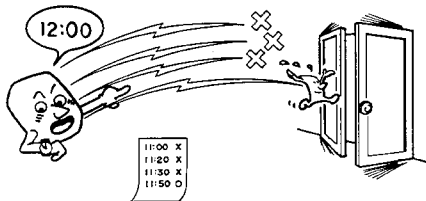

See page 35.

Protection against Wrong Connections

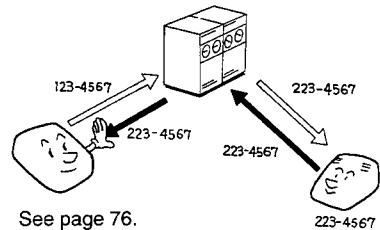

See page 76.

HOW TO USE THIS MANUAL

MANUAL OVERVIEW

Your facsimile machine is equipped with a wide range of labor-saving and cost-saving features. This manual explains each of these features, and how you can put them to use. Note that the external appearance of the machine in some illustrations may be slightly different from the actual machine.

The manual consists of the following sections.

- How to Use this Manual** - This is the section that you are now reading. It contains an overview of the manual and the conventions used by the authors. It also contains quick reference sections on how to input telephone numbers and names, and how to correct errors that you may inadvertently make when operating the machine.
- General Precautions** - This section lists precautions that you should keep in mind when operating the machine. Read this section before you begin to use your machine.
- Guide to Components** - This contains a diagram that shows where the main components of your machine are situated.
- Operation Panel** - This describes the functions of the various buttons and indicators that are on your machine's operation panel.
- Routine Operation** - This section describes the features and settings that you will normally be using every day.
- Advanced Features** - This section explains how to take advantage of the special features of your fax machine, including how to set up networks for economical distribution of fax messages over long distances.
- Reports** - This section explains the reports that the machine generates.
- Looking After the Machine** - This section shows you what to do when consumable supplies run out. The user maintenance procedure in this section should be done every six months if you want to keep your machine in top condition.
- Solving Problems** - If your machine cannot communicate, or if it generates error codes or experiences paper jams, refer to this section. Many routine problems can be solved without a service call.
- Specifications** - This is a list of technical capabilities of your machine.
- Installing the Machine** - This section explains how to install the machine and connect it with line. And it explains also the best type of place to install your machine.
- Before you Send your First Fax** - This section explains the things that you have to do before you can send your first fax message and lists important features that will make faxing more convenient.
- Quick Reference Guide** - This indicates how to use this machine at a glance.

Most procedures start from standby mode, that is, when the display is as shown on the right. The value after "READY" shows how much memory space is remaining.

```
READY  100% 10:00AM  
SET DOC. OR DIAL NO.
```

Note: If you start a procedure and do not enter anything at the operation panel for more than 3 minutes, the machine returns to standby mode.

Symbols

The text contains a few symbols that highlight important points or direct you towards other parts of the manual that are related to the feature currently being described.



indicates a hint (for example, indicating a page number where related information can be found).

GENERAL PRECAUTIONS

WARNING: Do not attempt any maintenance or troubleshooting other than that mentioned in this manual. This machine contains a laser beam generator and direct exposure to laser beams can cause permanent eye damage.

POWER AND GROUNDING

Pay attention to the following.

Power Supply

1. Power requirements: 115 V, 60 Hz
2. Insert the power plug securely into the wall socket.
3. Make sure that the wall outlet is near the machine and readily accessible.
4. Do not connect other equipment to the same socket.
5. Do not step on or set anything on the power cord.
6. Do not connect other equipment to the same extension cord.
7. Be sure that the power cord is not in a position where it would trip someone.
8. The wall outlet must be easily accessible.

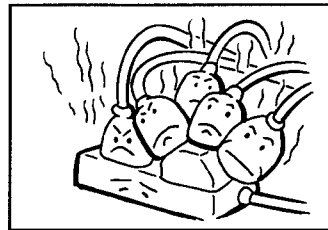
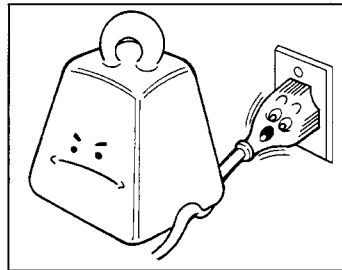
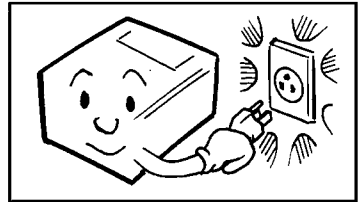

Grounding

Ground the machine and the lightning protection circuit in accordance with regulations. Do not ground to gas or water pipes, or to a telephone ground plug. Proper grounding is to the ground terminal of the power outlet. Be sure that the ground terminal of the power outlet is properly grounded.

The lightning protection circuit for the machine requires the machine to be properly grounded. If proper grounding is provided, about 90% of lightning damage can be prevented. For safety, be sure to connect the machine to a three-prong grounded outlet.

COLD WEATHER POWER-UP

Avoid raising the room temperature abruptly when it is below 57°F, or condensation may form inside the machine.

1. Raise the room temperature to 68°F at less than 18°F per hour.
2. Wait for 30 to 60 minutes.
3. Turn the power on.

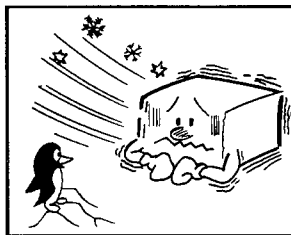

Do not use the machine near a humidifier.

THUNDERSTORMS

With proper grounding, about 90% of lightning damage can be prevented. However, if possible, during severe electric storms turn the power switch off and disconnect the power cord and telephone line cord.

Note: All fax messages stored in the memory may be erased if power is switched off for more than an hour.



COPY PAPER

- 16 to 24 lb. copy paper is recommended: letter or legal sizes are the most commonly used.
- Do not use damp paper, or copies will be defective.
- Do not touch copy paper if your fingers are wet or oily; fingerprints may appear on the copy.
- Keep paper in a vinyl bag if it will not be used for a long time.
- Store in a cool dry place.
- Store flat. Do not stand upright.
- The following materials cannot be used in the paper trays: Post cards, Tracing paper, OHP sheets, Adhesive labels
- Do not overload the paper trays.
- If multi-sheet feeding occurs or dog-eared copies are made when using recycled paper in the paper tray, fan the recycled paper and load it in the paper tray again.

TONER CARTRIDGES

- Store in a cool, dark place.
- Never store where they may be exposed to heat.
- Keep out of the reach of children.
- Do not eat toner.
- Do not lay heavy objects on toner cartridges.
- Do not incinerate toner or toner containers. Toner dust may cause flashback when exposed to an open flame.

OPERATING PRECAUTIONS

- While the machine is in operation, do not turn off the main switch or unplug the power cord.
- Keep corrosive liquids, such as acid, off the machine.
- Do not allow paper clips, staples, or other small metallic objects to fall inside the machine.
- The fusing unit may be very hot. Be careful when handling it.

GENERAL

- Read the Important Safety Information at the front of this manual.
- Since some parts of the machine are supplied with high voltage, make sure that you do not attempt any repairs or attempt to access any part of the machine except those described in this manual.
- Do not make modifications or replacements other than those mentioned in this manual.
- When not using the machine for a long period, disconnect the power cord.

OZONE

The machine generates ozone during operation. Normally, the ozone level is safe for operators. However, during a long copy run or while printing a long message, ozone odor may appear; in such a case, ventilate the room.

WARNING:



This symbol is intended to alert the user to the presence of important operating and maintenance (servicing) instructions in the literature accompanying the machine.



This symbol is attached to some components to alert the user not to touch them, because they may be very hot.

GUIDE TO COMPONENTS

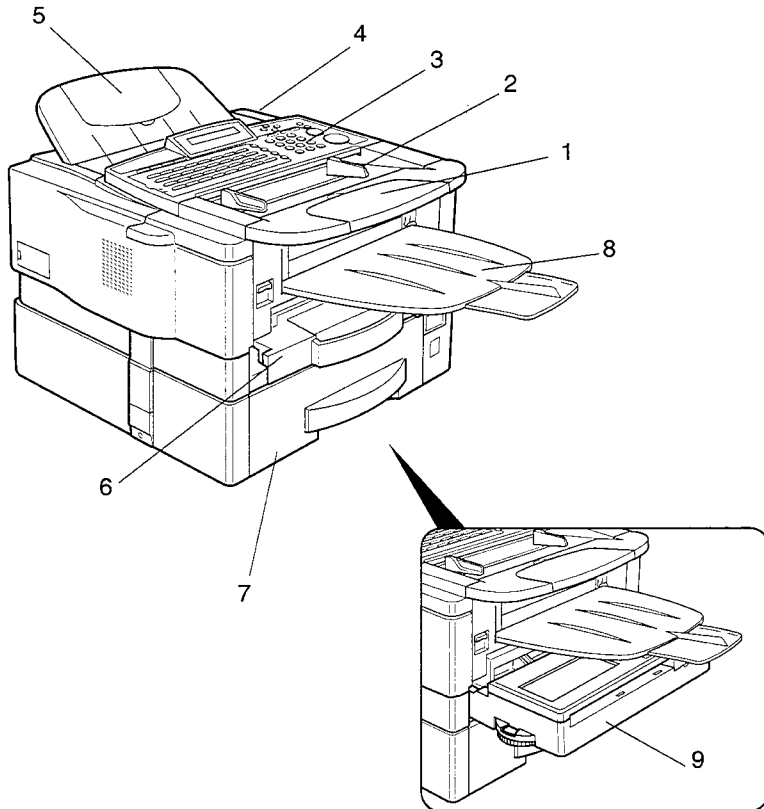

MAIN BODY

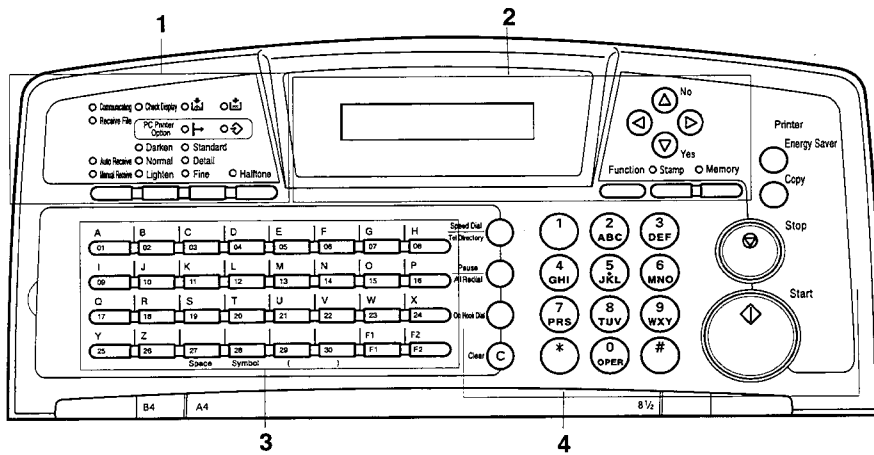

1	Document Table
2	Document Guide
3	Operation Panel
4	Power Switch
5	Document Tray
6	Paper cassette
7	Optional Paper Feed Unit
8	Copy Tray
9	Optional Removable Cassette

OPERATION PANEL



1.	Communicating Indicator	Lights when a fax message is being transmitted or received
	Receive File Indicator	Lights when an incoming message was received into memory. Blinks when confidential reception file or memory lock file is stored in the memory.
	Check Display Indicator	Lights when some error occurs. See the instruction appearing on the display.
	Add Toner Indicator 	Blinks when the toner cartridge is almost empty, and lights when it is empty.
	Add Paper Indicator 	Lights when a cassette is empty.
	PC Printer Option Indicators	These indicators are only used when the optional Printer Interface Kit is installed. See the operation manual for the Printer Interface Kit for full details.
	Reception Mode Selector Key	Press to select Auto Receive or Manual Receive.
	Contrast Selector Key	Press this to select either Darken, Normal or Lighten
	Resolution Selector Key	Press this to select either Standard, Detail, or Fine transmission mode.
	HalfTone Key	Press this to use halfTone transmission mode.

2.	Display	Displays prompts, warnings, and selected modes.
	Stamp Key	Press to enable or disable the transmission.scanning verification stamp feature.
	Function Key	Press to use one of the numbered functions explained in this manual.
	Yes/No Keys	Use to answer questions on the display.
	Scroll Key	When an arrow is shown on the display, use this key to access the options, items, or functions shown by the arrow. Also use it to move the cursor when programming or editing a displayed item.
	Memory Key	If the indicator is lit, your document will be stored before transmission. If it is not lit, your document will be sent immediately without being stored. Press the key to change the mode.
3.	Quick Dial Keys	Each of these can be programmed with a telephone number, a group, or a keystroke program. You can also use these keys to type names and labels such as the RTI and TTI.
	User Function Keys	Each of these can be programmed for rapid access to frequently used features. If the light under a key is on, the feature can be used.
4.	Speed Dial Key	Press this to dial using Speed Dial feature.
	Pause/Redial Key	Press this if you need to insert a pause when dialing. Or press this to redial the last number that was dialed.
	On Hook Dial Key	Press this to dial without picking up the handset.
	Clear Key	Use this as a backspace key during programming.
	Ten Key Pad	Use this as a telephone keypad, or to enter Speed Dial codes.
	Energy Saver Key	Hold a few seconds this to start or end the energy saver mode.
	Copy Key	Press this to copy the document now in the feeder.
	Stop Key	Press this to stop the machine and return it to standby mode.
	Start Key	Press this to start fax communication.

This page is intentionally blank

ROUTINE OPERATION

SENDING A FAX MESSAGE

Precautions Concerning Unacceptable Document Types

Before you send your document, make sure that it meets the following requirements.

CAUTION: Documents that do not meet these requirements can cause your machine to jam or may cause some components of the machine to become damaged or dirty.

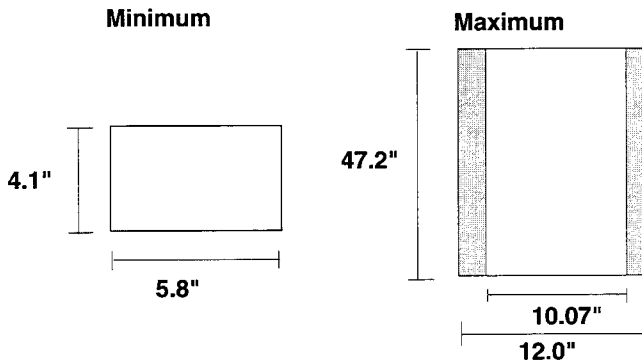

- The part shaded  will not be scanned, because it is outside the maximum scanning width range.

Correct Size for the Document Feeder

Thickness: 2 to 8 mils (20 lb paper).

Length and Width: See the above diagram.

If the page is too short, put it inside a document carrier or enlarge it with a copier.

If the page is too long, divide it into two or more sheets.

Clearly Written

Small faint characters may not be transmitted clearly.

Uniform Page Size

Do not use different sizes of document in the same transmission.

Dry Ink

All ink must be dry before you place the document in the feeder.

Page Condition

Do not place damaged pages in the automatic document feeder.

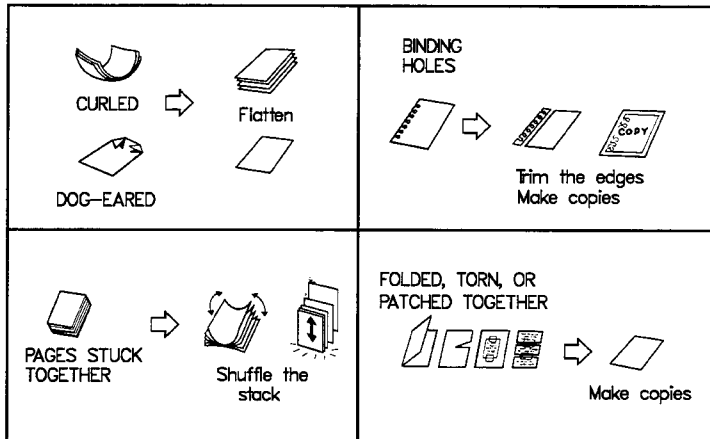

Originals that contain the following materials should not be placed in the document feeder. Make copies of these originals and scan the copies.

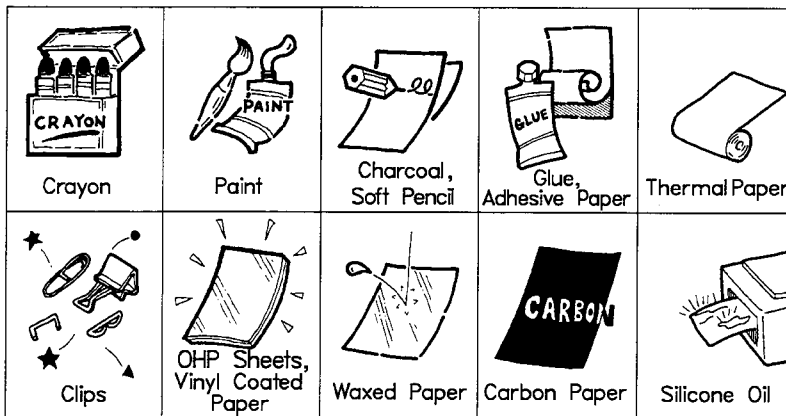

Note: Copies made with a copier that uses silicone oil may cause a misfeed. To avoid this, do not scan such copies until five or ten minutes after copying.

Transmission Procedure at a Glance

Overview

There are two ways to send a fax message.

- Immediate Transmission
- Memory Transmission

Immediate Transmission

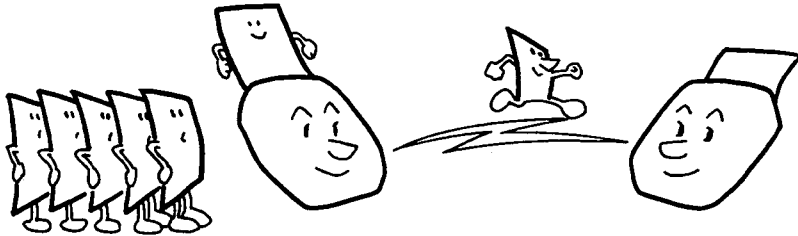

Immediate Transmission is convenient when:

- You wish to send a message immediately.
- You quickly wish to check whether you have successfully connected with the other party.
- Your machine's memory is getting full.

The machine dials immediately after you press Start (or at the specified later time, if you used a time-delay feature like Send Later). The message is scanned and transmitted page by page without being stored in memory.

Memory Transmission

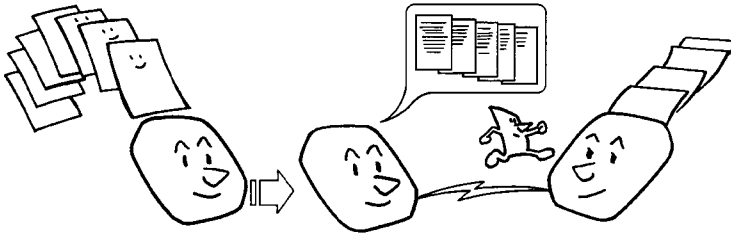

Memory Transmission is convenient because:

- Fax messages can be scanned much more quickly (you can take your document away from the fax machine without waiting too long).
- While your fax message is being sent, another user can operate the machine (people will not have to wait by the fax machine too long).
- You can send the same message to more than one place with the same operation.

After you press Start, the machine doesn't dial until all the pages of your fax message have been stored in the memory.

The default mode of this machine is Memory Transmission, so the procedures described in this manual will be based on the assumption that you are using Memory Transmission. Immediate Transmission is described in a separate section.

Cross-references: Sending at a Specific Time: see page 34.

Parallel Memory Transmission

With this feature the machine can call destinations while scanning documents. Compared with normal Memory Transmission where the machine calls once all the documents have been stored, it is quick to verify whether a connection has been made or not.

Additionally, as scanning finishes more quickly than Immediate Transmission, it is useful if you want to take the document back to your desk immediately. However, if the connection cannot be made (for example if the line is busy), normal Memory Transmission takes place.

Note: If the amount of available memory is less than 50%, you cannot use Parallel Memory Transmission.

Normal Memory Transmission still takes place when using the following:

- Send Later
- Transfer Request
- Specify Multiple Destinations

The file is erased if any of the following happen during transmission:

- The Stop key is pressed.
- A document becomes jammed.
- There is not enough memory available.

After a parallel Memory Transmission fails, a communication result report or a communication failure report is printed.

When using Parallel Memory Transmission, page numbers are not printed at the other end. If you want page numbers printed, use Printing the Page Number of the optional feature for transmission. (See page 36.)

Sending to Just One Location

1. Make sure that the machine is in standby mode:
The display on the operation panel must be as shown on the right.
2. Carefully place your fax message face down into the auto document feeder.

```
READY 100% 10:00AM
SET DOC. OR DIAL NO.
```

```
TRANSMIT OPTION▶
DIAL FAX NUMBER
```

Note: You can dial without placing the message in the feeder first.
Place the document after you dial the number and go to step 4.

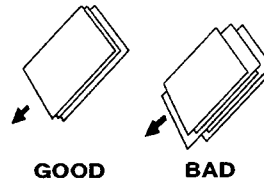
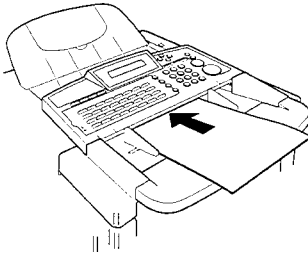

- The pages must be placed face down in the feeder, with the first page at the bottom of the stack.
- Feed the pages in so that the top edge goes in first.
- Do not feed in more than 30 pages.
- Do not use unsuitable types of original (see pages 15 and 16).
- Adjust the document guides to fit the width of the pages.

- Do not use pages of different sizes.
- The pages should be arranged loosely, but the leading edges should be tidy, as shown above.



Selecting Contrast and Resolution: See page 26.
Options for Sending a Message: See page 32.

3. Dial in one of the following ways.

TRANSMIT	Y/START
2125551234	■■■■■■■■■■

a) Ten Key Pad	b) Quick Dial	c) Speed Dial	d) Handset *
	<p>Example: Quick Dial 12</p>	<p>Example: Speed Dial 10</p>	

* Only if the telephone handset is installed.

If your machine is behind a PBX, dial the access code, then a pause, then the telephone number. For an international number, press the Pause key after entering the country code.

4. **Start.**

- The machine stores your fax message.
- The machine dials, and the line to the other party is connected.

Note: Watch the display. The identification of the other party will appear.

NEW YORK OFFICE
A4 → A4 TRANSMIT

- After sending the message, the machine hangs up automatically.

Sending to More Than One Location (Broadcasting)

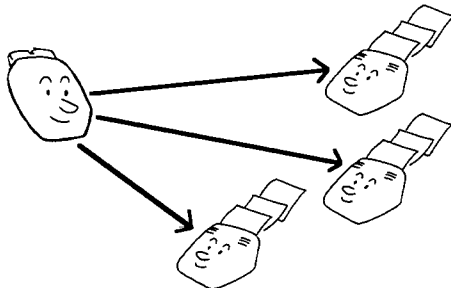

1. Make sure that the machine is in standby mode (see page 20).
2. Make sure that the Memory indicator is lit. If it is not, press **Memory**.
3. Place your fax message face down into the feeder.
 - You can dial without placing the message in the feeder first. Place the document after you dial the number and go to step 5.

TRANSMIT OPTION▶
DIAL FAX NUMBER

? Selecting Contrast and Resolution: See page 26.
Options for Sending a Message: See page 32.

4. Dial in one of the following ways.

TRANSMIT Y/START
12225553333 ■■■■■■■■▶

a) Ten Key Pad	b) Quick Dial	c) Speed Dial	d) Group Dial ★
	<p>Example: Quick Dial 12</p>	<p>Example: Speed Dial 10</p>	<p>Example: Group 1. stored in Quick Dial Key 08</p> <p>08 of the Quick Dial Key</p>

★ Method: Press the Quick Dial Key the Group is stored in (in the example, press key 08).

If your machine is behind a PBX, dial the access code, then a pause, then the telephone number. For an international number, place a pause after the country code. To input a pause, press the Pause key.

5. **Yes.**

TRANSMIT DIAL/START
DIAL NEXT FAX NUMBER

6. **Either**

- Dial another number: Go to step 4.
- Press **Start**.

The machine will dial the first destination (or, if you selected Send Later, it will return to standby mode and the fax message will be sent at the time that you selected).

Note: In theory, you can send the same fax message to up to 132 different destinations using the above procedure. However, this number depends on how many numbers are currently waiting in memory to be dialed. See the table on page 221 for more information concerning the limitations to this feature.

Transmission using the Group key

The followings are the procedure using the Group key. You have to program the Group key into the Quick Dial 30 (Programming the Group Dial. See page 217).

1. Place a document into the feeder.

TRANSMIT OPTION ►
DIAL FAX NUMBER

2. Press **30** of the Quick Dial key (Group key).

GROUP 1-7/N
G■

3. Enter a Group number.
Example 1; press **1** of the ten key pad.

GROUP Y/START
G1 DISTRIBUTOR

4. **Start.**

ROUTINE OPERATION

Possible Problems

You want to take out the document

Open the scanner, and take out the document.

CAUTION: Do not pull out the document without opening the scanner, or you will damage the machine.

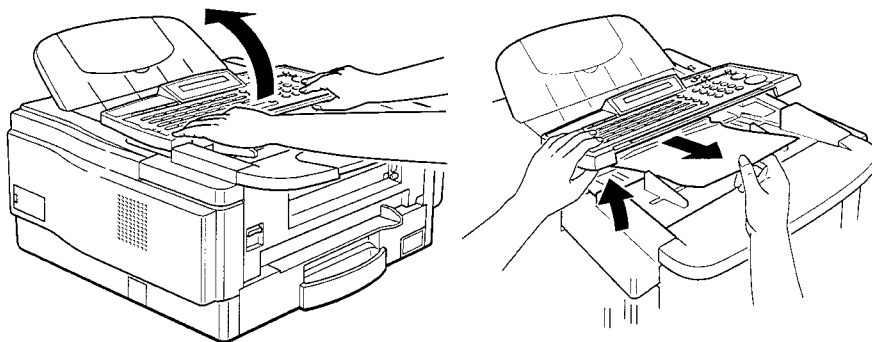

You want to send more than 30 pages

While the last page is being fed in, place more pages (up to 30) in the feeder.

You made a mistake while dialing

If you already pressed **Start**, press **Stop** immediately.

If you haven't pressed **Start** yet, either:

- No**. The entire number is deleted. Enter a new number.
- Clear**. Only the last digit is deleted.

Check Display Indicator are blinking

- If the **CLEAR ORIGINAL** appears in the display:
Take out the document (see page 166). Then redial the destination.
- If the **ERROR PRESS STOP KEY** appears in the display:
If the Communicating lamp is not lit, press **Stop**.
If the Communicating lamp is lit, wait until it goes out, then press **Stop**.

The buzzer is ringing

The other party wishes to speak with you. Proceed as shown below.

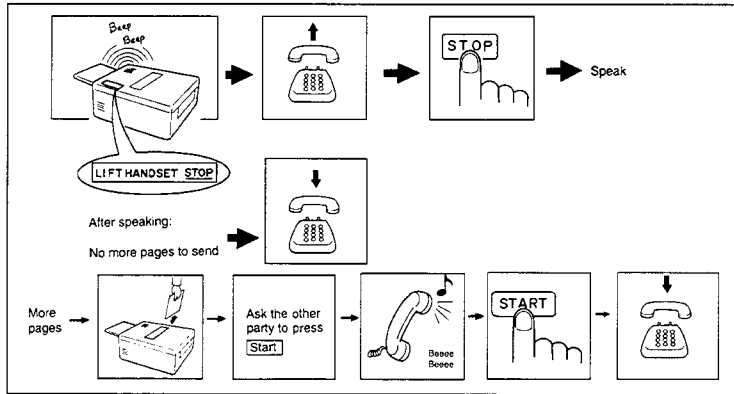

If the other party's line is busy, your machine will dial again.

```
READY 95% 10:00AM
SET DOC. OR DIAL NO.
```

If the other party's fax machine answers, both machines will connect and yours will send the message.

```
(a number or label)
SET DOC. OR DIAL NO.
```

TIP: If your line goes through a local switchboard (a PBX) remember to dial the exit code. Press the Pause key immediately after the code. If the number includes a country code, press the Pause key after the country code, then dial the rest of the number.

Cancelling the Memory Transmission

If you like to cancel the transmission, press the **Stop** key during communication.

```
5551234
STOP & CLR FILE? Y/N
```

Then press **Yes** to cancel the transmission.

ROUTINE OPERATION

Sending a Page with Very Fine Detail

You may wish to send many different types of fax message. Some of these may be difficult to reproduce at the other end. However, your machine has three settings that you can adjust to help you transmit your document with the best possible image quality.

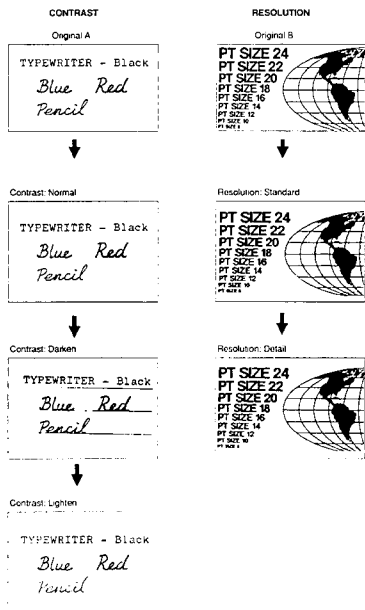

If you are not sure whether your settings are suitable, make a copy of the document using these settings. The printout shows how the fax message will look when it is printed at the other end.

- If your fax message has more than one page, you can select different settings for each page. For example, if you wish to use a different resolution just for page 2, change the resolution setting while page 1 is being scanned. Then, while page 2 is being scanned, you can return the resolution setting to the original setting.

Contrast

The text and diagrams in your document must stand out clearly from the paper they are written on. If your document has a darker background than normal (for example, a newspaper clipping), or if the writing is faint, adjust the contrast.

There are three grades.

Normal: Suitable for most documents

Darken: Use for documents with faint writing (such as those written in pencil)

Lighten: Use for documents that have a dark or patchy background

Resolution

If your document contains fine print or detailed diagrams, use a higher resolution setting.

Standard: Suitable for most typewritten documents

Detail: Use for documents with small print or fine details

Fine: Use this for high quality reproduction

Halftone

If your document contains a photograph, or diagrams with complex shading patterns or grays, switch Halftone Mode on to achieve optimum image quality.



Without Halftone



With Halftone

Selecting the Halftone Type

This model has two types of Halftone: the Dither Process and the higher quality Error Diffusion Process. To change the currently used Halftone type, perform the following procedure.

1. **Function 6 2 2 2 2 6 3** and **Yes**.

```
SETTING                Y/◀
PRINT LIST ◀
```

2. **Yes**.

The settings for switch 00 are now shown on the bottom line of the display.

```
                KPAD/Y/◀▶
SWITCH 00 : 0000 0000
```

3. Press ▶ until the settings for switch 10 are shown. You need to change digit 7. If you wish change the setting press 7 on the ten key pad.

```
                KPAD/Y/◀▶
SWITCH 10 : 1000 0000
```

Speed mode: The machine will use the Basic Halftone Process.
Standard mode: The machine will use the higher quality Error Diffusion Process.

4. Finish: **Yes** and **Function**

Halftone Mode slows down the transmission speed, and may increase your communication costs, especially if you use the Error Diffusion process. Higher resolutions also do this. This is because these settings create larger amounts of data to be sent.

Messages are transmitted the fastest if you use the standard resolution setting, and keep Halftone off.

Home Position Setting Adjustments

For the contrast, resolution, and halftone, you can select whether the settings return to home position at the end of transmission (in a new machine, they do). Also, you can change the home positions of these settings.

If you need other adjustments, contact a service representative.

The procedure is as follows (see page 184 if you need more information about the User Parameter settings adjustment procedure).

- Function 6 2 2 2 2 6 3 and **Yes**.

At this time, you can print a User Parameter List if you press **◀** and **Start**.

```
SETTING?          Y/◀
PRINT LIST ◀
```

- Yes**.

```
                KPAD/Y/◀▶
SWITCH 00 : 0000 0000
```

- The settings for switch 00 are now shown on the bottom line of the display.

```
SWITCH00: 0000 0000
Digit      7 6 5 4 3 2 1 0
```

The digits are numbered from 7 to 0; the setting of digit 7 is shown at the left side of the display and digit 0 is at the right.

The settings that you may need to change are those for digits 0, 1, 2, 3, 4, 5, 6, and 7. The functions of these are as follows.

Digit	Purpose							
0	Stamp	0: Off*			1: On			
1	Contrast home position							
2		Digit 2	Digit 1	Setting				
		0	0	Normal*				
		0	1	Lighten				
		1	0	Darken				
3	Do not change this setting.							
	Resolution home position							
4		Digit 5	Digit 4	Setting		Digit 5	Digit 4	Setting
5		0	0	Standard*		1	0	Fine
		0	1	Detail		1	1	Do not change these settings.
6	Transmission mode home position							
	0: Memory transmission*			1: Immediate transmission				
7	Halftone on/off home position			0: Off*		1: On		

* Factory setting

4. If you wish to change one of the settings, press the key on the ten key pad that corresponds to the digit that you wish to change.

Example: **3** from the ten key pad. The value of digit 3 changes.

5. Finish: **Yes** and **Function**.

Dialing with the Telephone Directory

This can be done for any number that you have stored as a Speed Dial code with a label programmed for it.

Example: You wish to Dial "XYZ CO. LONDON".

1. Make sure that the machine is in standby mode.
2. Carefully place your fax message into the auto document feeder.
3. Press **Speed Dial/Tel Directory**.
4. Press the first letter of the name.
5. If the label you want does not appear, scroll through the labels using ◀ and ▶ until you find it.
6. Press **Yes** to dial the number you want.
7. Either:
 - Dial more numbers.
 - Press **Start**.

```
READY 100% 10:00AM
SET DOC. OR DIAL NO.
```

```
TRANSMIT OPTION▶
DIAL FAX NUMBER
```

```
SPEED DIAL 0-9
PUSH NUM OR ABC
```

```
TEL DIR. Y/◀▶
☒ 01XA COMPANY
```

```
TEL DIR. Y/◀▶
☒ 12 XYZ CO. LONDON
```

Cross-references: Speed Dial: see page 209.

Optional Features for Transmission

When you make a routine transmission, you can access a few optional features.

These options are only available if "OPTION ►" can be seen in the top right corner of the display.

Personal Code



Personal Codes do the following.

- They allow you to keep track of machine usage (for example, for billing purposes). If everybody uses a Personal Code when they use the fax machine, the codes, or the names programmed into the codes, will be printed on the report that is called the Journal. This will help you to check on who has been using the machine, and how often.
- They allow personalization of documents and printed reports. For example, if you use Label Insertion and store your name with your Personal Code, the receiver of your fax message will see your name at the top of the printout. This eliminates the need for a cover page.
- They allow you to restrict use of the machine to authorized personnel only. If you switch the Restricted Access feature on, users have to enter their personal code before they can use the machine. The personal code must have already been stored in the machine. This may deter unauthorized personnel from casually using the machine.

Cross-references:

Programming Personal Codes: see page 66.
Restricted Access: see page 66.

Journal: see page 137.
Label Insertion: see page 74.

If you input your Personal Code, your name will appear on the JOURNAL and Transmission Result Report.

1. Press ► and make sure that the display is as shown opposite.

```

SET OPTION          Y/►
SET PERSONAL CODE?
    
```

2. **Yes.**

```

SET OPTION          KPAD
PERSONAL CODE: ■■■■
    
```

3. Enter the personal code
Example: **7 3 6 2**

```

SET OPTION          Y/N
PERSONAL CODE: 7362
    
```

4. **Yes.**

? For details on how to program the Personal Codes and their Labels. See page 67, Storing a Personal Code.

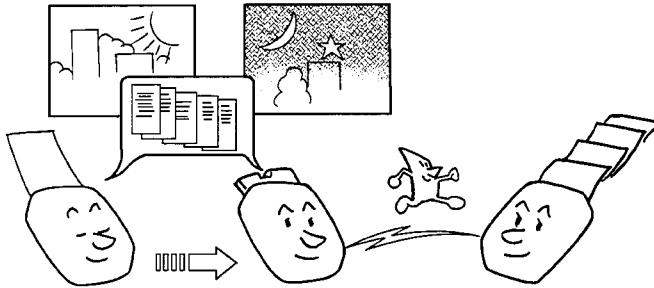
Sending at a Specific Time

This feature is called **Send Later**.

Using this feature, you can instruct the machine to delay transmission of your fax message until a later time, which you specify. This allows you to take advantage of off-peak telephone line charges without having to be by the machine at the time.

CAUTION: If your machine's memory is full, you will have to keep the message in the document feeder. This means that nobody can use the document feeder unless they remove your document. This would automatically cancel the Send Later operation.

1. Press **▶** until the display is as shown opposite and **Yes**.

```
SET OPTION      Y/▶
SEND LATER?
```

2. Example: Send at 11:30pm
1 1 3 0 from the ten key pad.
To change AM/PM, press * or # on the ten key pad.

```
SET OPTION      KPAD/Y
TIME 11: 30PM  10: 00AM
```

3. **Yes**.
The Send Later time cannot be more than 24 hours into the future.

```
TRANSMIT      OPTION ▶
DIAL FAX NUMBER
```

Sending by a Specific Time (TRD)

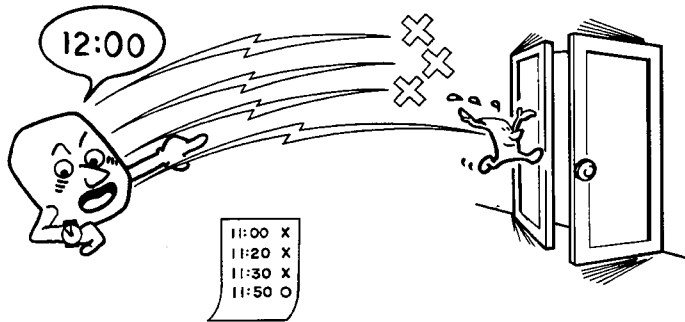

This feature is called **Transmission Deadline**.

If your message has to be sent to the other end before a certain time, use the Transmission Deadline option and input this deadline.

If the line is busy, the machine will redial at set intervals either until the message gets through or until the deadline passes. Before the deadline passes, there is no limit to the number of times that the machine can redial.

This feature is only available with Memory Transmission.

ROUTINE OPERATION

1. Press **▶** until the right display appears.

```
SET OPTION      Y/▶
SET TRD?
```

2. **Yes.**

```
SET OPTION      KPAD/Y
TIME 12:00PM    10:00
```

3. Example: The deadline is 12:50AM.

1 2 5 0

To change AM/PM, press * or # on the ten keypad.

```
SET OPTION      */#/Y
TIME 12:50AM    10:00AM
```

- The TRD time cannot be more than 24 hours into the future.

4. **Yes.**

```
TRANSMIT      OPTION▶
DIAL FAX NUMBER
```

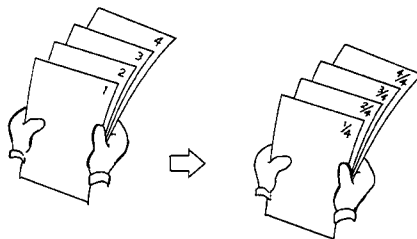
Printing the Page Number (Immediate Transmission or Parallel Memory Transmission only)

This feature is called **Page Count**.

When your fax message is printed at the other end, page numbers will be printed on the top of each page. Using the Page Count feature, you can select the format in which the page numbers are printed.

If you use Page Count:

- Page numbers will be printed in batch-numbering format (for example, p1/3, p2/3, and p3/3 for a three-page message). This makes it easy for the other party to see how many pages you sent, and if any are missing. However, you have to input the number of pages at the keypad before sending.

If you do not use Page Count:

- Page numbers will be printed only as a sequence (for example, p1, p2, p3). This makes it difficult for the other party to tell at a glance whether any pages are missing (for example, due to a double feed in your machine's document feeder).

Note: If you do not select Immediate Transmission and Parallel Memory Transmission, Page Count is automatically switched on, and the pages are counted automatically.

1. Press **▶** until the right display appears.

SET OPTION	Y/▶
SET PAGES?	

2. **Yes.**

SET OPTION	KPAD
PAGES■■■	

3. Example: 10 pages
10

SET OPTION	Y/N
PAGES10	

4. **Yes.**

Sending Your Identification at the Top of Your Message

Normally, the TTI programmed in your machine is printed at the top of each of the pages you transmit when they are received at the other end. The top of the image will be overprinted if there is no margin at the top of the transmitted page.

In some cases, you may wish the other party to receive an unmarked copy of your original. In this case, you can switch TTI off.

Note: If you switch TTI off, make sure that Label Insertion is also off if you want the image received at the other end to be unmarked.

Cross-reference: TTI: see page 206.	Label Insertion: see page 74.
---	-------------------------------

1. Press **▶** until the right display appears.

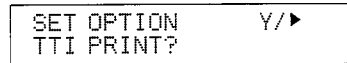

2. **Yes.**

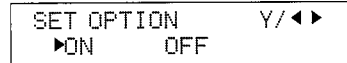

3. If you wish to change the TTI setting, press **◀** or **▶** until the displayed setting is correct.

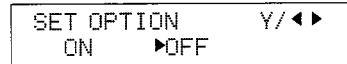

4. **Yes** when you have finished.

ROUTINE OPERATION

Sending Quickly

Procedure

If you do not wish to store the fax message in memory before sending it out, use the following procedure.

- The advantages and drawbacks of Immediate Transmission and Memory Transmission are discussed on pages 17 and 18.

1. Make sure that the machine is in standby mode (see page 20).
2. Make sure that the Memory indicators should go out. If it is lit, press **Memory**.
3. Place the document face down into the feeder.

```
TRANSMIT  OPTION▶
DIAL FAX NUMBER
```

4. Dial (only one destination).

```
TRANSMIT  Y/START
2125551234■■■■■■■■■■
```

 See page 21 for how to dial.

5. **Start.**

```
2125551234
DIALING
```

6. The machine dials and the line to the other party is connected. The number that you dialed is displayed (or if you used Quick Dial or Speed Dial, the Quick Dial or Speed Dial Label stored for that number is displayed).

Changing Transmission Mode

Converting Immediate Transmission to Memory Transmission

If there is a message still waiting in the document feeder, you can convert it into a memory file if you press **Memory** and **Start**. The document will be scanned and stored into memory, leaving the document feeder free for others to use.

Immediate Transmission as Your First Choice

The default mode of your machine is Memory Transmission. If you wish, you can change this home position to Immediate Transmission.

The procedure is as follows (see page 184 if you need more information about the User Parameter settings adjustment procedure).

1. **Function 6 2 2 2 2 6 3** and **Yes**.

```
SETTING?          Y/◀
PRINT LIST ◀
```

- At this time, you can print a User Parameter List if you press ◀ and **Start**.

2. Press **Yes**. The settings for switch 00 are now shown on the bottom line of the display.

```
                KPAD/Y/◀▶
SWITCH 00 : 0000 0000
```

The setting that you need to change is that for digit 6.

3. If you wish to change the setting, press **6** on the ten key pad.

```
SWITCH 00 : 0000 0000
```

Digit 6:(Double underlined)
0: Memory Transmission
1: Immediate Transmission

4. Finish: **Yes** and **Function**.

Using the Stamp

Press the Stamp key to achieve the transmission verification stamp. When the Stamp indicator is lit, the machine stamps a small mark on the bottom of each page. During memory transmission, the stamp indicates that the page was successfully stored. For immediate transmission, it shows that the page was sent successfully. You must switch the stamp on before you press **Start**, or the machine will not stamp the first page.

Changing the Stamp Home Position Setting

If you wish to change the Stamp default setting, do the following.

(See page 184 if you need more information about the User Parameter settings adjustment procedure).

1. **Function 6 2 2 2 2 6 3** and **Yes**.
At this time, you can print a User Parameter List if you press **◀** and **Start**.

```
SETTING?      Y/◀
PRINT LIST ◀
```

2. Press **Yes**. The settings for switch 00 are now shown on the bottom line of the display. The setting that you need to change is that for digit 0.

```
SWITCH 00 : 0000 0000
```

Digit 0(Double Underlined)
0: Verification stamp off
1: Verification stamp on

3. If you wish to change the setting, press **0** on the ten key pad.
4. Finish: **Yes** and **Function**.

Redialing

If a message was not transmitted successfully, that does not mean that you have to enter the telephone number again. In many cases, the machine will redial the destination automatically. Or, with the Redial key, you can redial with just a few keystrokes.

Automatic Redialing

The machine will automatically redial the other party if any of the following conditions occurred.

- The other party was busy
- There was no reply from the other party
- The message was rejected by the machine at the other end because of excessive errors (in this case, redialing will only take place if Memory Transmission was used)

Redialing is done 4 times at 5 minute intervals (for a memory transmission) or 2 times at 5 minute intervals (for an immediate transmission).

- The number of redials and the redial interval may be adjusted by a service technician.

During redialing, the number being dialed is displayed as shown on the right.

21255551234 DIALING

Using the AI Redial Key

The machine remembers the last 10 telephone numbers that you input. If you have to redial one of these numbers, just press the AI Redial key, until the required telephone number or name is displayed, then press the Start key.

This feature has the following uses.

- If the machine is waiting to redial the other party, you do not have to wait for the redialing interval to expire. Press **AI Redial** until the required telephone number or name is displayed, then press **Start**.
- If you wish to send another message to the same address that you sent one to recently, you don't have to dial the full number again if it is still in the Redial memory. Place the message in the feeder, then press **Start**.

Note: The AI Redial key employs the AI Short Protocol feature.

1. Follow both steps in any order.

- Press the **Pause/AI Redial** key until the required number appears in the display, then press the **Yes** key **twice**.

REDIAL	Y/◀▶
■ 01 XYZ CO. NEW YORK	

- Carefully place your fax message into the auto document feeder.

TRANSMIT	DIAL/START
DIAL NEXT	FAX NUMBER

2. Either:

- Select another number.
(Broadcasting)
- Start the transmission: Press the **Start**.

RECEIVING FAX MESSAGES

Selecting the Reception Mode

There are two ways to set up your machine to receive fax messages.

- Auto Receive Mode
- Manual Receive Mode

Press the reception mode key to switch between the modes.

Auto Receive Mode

This mode is selected when the Auto Receive indicator is lit.

Incoming faxes are received automatically. You do not have to be by the machine if the power switch is kept on. Use this mode when you must leave the machine.

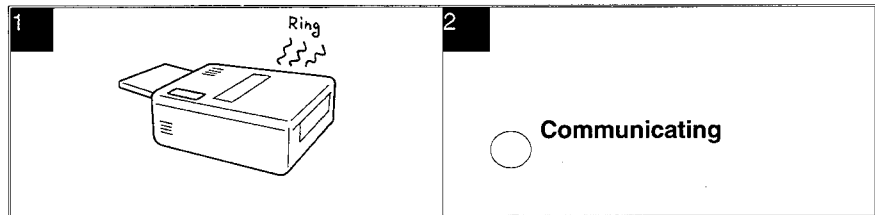

1. The telephone rings once.
2. The machine automatically starts to receive the message.

Manual Receive Mode

This mode is selected when the Manual Receive indicator is lit.

This setting is convenient if you wish to use your fax machine's handset to answer telephone calls coming in on the same line as fax messages. However, your fax machine cannot automatically receive fax messages; you have to be by the machine if a fax message comes in.

The machine operates as follows.

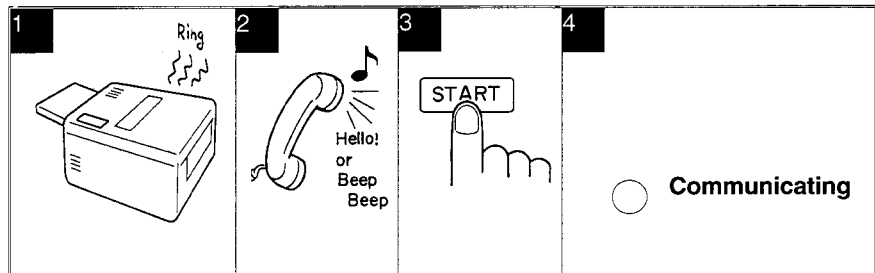

1. The machine rings continuously until you answer the call. Pick up the handset.
2. If you hear a voice from the other end, speak in reply.
If you hear a tone every few seconds, the other end is a fax terminal.
Note: Remove any documents that are in the feeder.
3. If the person at the other end wishes to send you a fax message, press **Start** to receive the message. Then hang up the handset.
4. The machine starts to receive the message.
The Communicating indicator lights.

Receiving Fax Messages When There Is a Problem

Overview

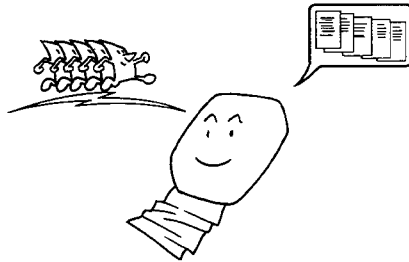

This feature is called **Substitute Reception**.

If the printer is jammed or out of supplies, you will still be able to receive fax messages; any messages coming in will be stored in the machine's memory.

If the "Receive File" indicator is lit, a message has been stored in the memory using the Substitute Reception feature.

Check the following:

- The printer paper may be used up. If so, add paper: see page 146.
- The toner may have run out. If so, add toner: see page 147.
- The printer paper may have jammed. If so, remove the jam: see page 168.
- If there appears to be no problem, somebody may be making copies while a fax message is coming in.

The messages received into memory will be printed and erased after the machine has been returned to normal operation.

Switching Substitute Reception On or Off

There are two conditions under which you may wish to disable this feature.

- ❑ If you do not like keeping received fax messages in memory: After your machine has received a fax message to memory, it sends an OK signal to the other end. However, if something happens to your machine and you lose the fax message before you have a chance to read it, the sender will not be informed. Therefore, you may not wish to use the Substitute Reception feature.
- ❑ If you do not wish to have your memory full of mail from unknown senders: If you have not enabled the Authorized Reception feature, you can receive fax messages from anybody. However, you can see who they are because their identifier (the TTI) is printed at the top of each page. If the other party has not programmed their identifiers (perhaps in an attempt to hide their identity), you may not wish to receive their messages into memory, which would take up valuable space.

Cross-reference:
 ECM: see page 77. Authorized Reception: see page 89.

If you wish to switch Substitute Reception on or off, do the following procedure. (See page 184 if you need more information about the User Parameter settings adjustment procedure).

1. **Function 6 2 2 2 2 6 3 and Yes.**
 At this time, you can print a User Parameter List if you press ◀ and **Start**.
2. The settings for switch 00 are now shown on the bottom line of the display.
3. Press ▶ until the settings for switch 05 are shown.
 The settings that you need to change are those for digits 0 and 1.
 The meanings of these settings are as follows.

SETTING? Y/◀
 PRINT LIST ◀

KPAD/Y/▶▶
 SWITCH 00 : 0000 0000

SWITCH 05 : 0000 0000
 Digit 0 (Underlined)
 Digit 1 (Double Underlined)

Digit	Purpose
0	Substitute Reception 0: Off 1: On*
1	Reception to memory (including Substitute Reception, Memory Lock and Forwarding from another station) when no RTI or CSI identifiers were received from the other party 0: Enabled* 1: Disabled

* Default settings

4. If you wish to change the setting, press 0 or 1 of the ten key pad.
5. Finish: **Yes** and **Function**.

ROUTINE OPERATION

TELEPHONE CALLS

A handset is required to execute the procedures in this section.

You can use your fax machine for dialing in the same way as you would use a telephone. This is useful when calling fax machines that are usually kept in Manual Receive Mode, as well as for telephone conversations.

- You can dial using Quick Dial Keys or Speed Dial Codes.
- With the On Hook Dial feature, you do not have to pick up the handset before dialing.
- You can send a fax message after finishing the conversation, without having to make a new call.

Cross-reference:

Manual Receive Mode: see page 43.

Making a Telephone Call

Using On Hook Dial

Using On Hook Dial is like using the handset (see the next page), except that you do not have to pick it up before dialing. Just press the On Hook Dial key, and dial the number. When you hear the other party on the fax machine's built-in speaker, you can pick up the handset. This keeps both hands free for referring to telephone numbers while you are dialing.

1. Press the **On Hook Dial** key.

ON HOOK MODE

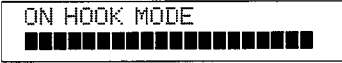

2. Dial.

 See page 21 for how to dial.
Do not use the handset.

Note: Do not press **Start**.
If you wish to cancel the call,
press the **On Hook Dial** key.

ON HOOK MODE

2125551234

3. Listen to your machine's built-in speaker. When the other party answers, pick up the handset.
4. Replace the handset when you have finished.

Answering the Telephone

If the telephone rings just once:

A fax is coming in. Do not pick up the handset.

If the telephone rings continuously:

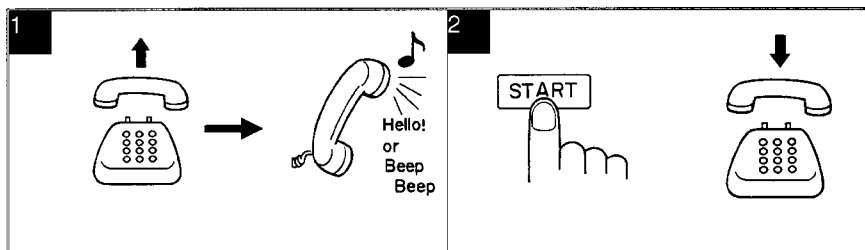

1. Pick up the handset and speak to the other party.
If you hear a high-pitched tone, a fax is coming in.
Press **Start** then hang up.
2. If the caller wants to send you a fax, press **Start** after speaking. Then hang up.

If nothing happens after you press Start the power may be switched off or the telephone may not be properly connected.

Phoning and Faxing on the Same Call

To Talk Before Sending a Fax (On Hook Dial)

1. Press the **On Hook Dial** key.
2. Dial.

Note: Do not use the handset.
Do not press **Start**.
3. If you hear a voice from the machine's built-in speaker, pick up the handset and speak to the other party.
 If you hear a high-pitched tone instead of a voice, place your fax message in the feeder, then press **Start**.
4. When you are ready to send your fax message, place your message in the feeder, then ask the other party to press **Start**.
5. When you hear a high-pitched tone, press **Start**.

- Replace the handset.

Do not replace the handset if you wish to speak to the other party again.
When your machine emits a tone, press Stop then speak.

Speaker and Buzzer Volume Adjustments

Your machine has a built in speaker. With this speaker, you can listen to the telephone line without picking up the handset. The speaker will be automatically switched off just before the start of facsimile data communication.

When you are sending a fax message, you will be able to hear the line after the machine has dialed. If the line is busy, you can press the Stop key and start another operation without having to wait for the machine to disconnect the line.

The sounds you can adjust the their volumes are;

Transmitting monitor (TRANS MONITOR): Sound you hear in transmission.

Receiving monitor (RECV MONITOR): Sound you hear in reception.

Onhook dial monitor (ONHOOK MONITOR): Sound you hear in dialing by Onhook dial.

Dialing monitor (DIAL MONITOR): Sound you hear after pressing Start key.

Buzzer tone (BUZZER): Volume of the buzzer when you open a cover and so on.

Key tone (KEY): Sound you hear when you press a key on the operation panel.

If the speaker volume is not satisfactory, you can adjust it.

- Function **6 2 2 2 9 2** and **Yes**.

TRANS MONITOR	Y/◀▶
MIN ▶▶	MAX

- To increase: ▶
To decrease: ◀
To accept: **Yes**

TRANS MONITOR	Y/◀▶
MIN ▶▶▶▶	MAX

- Repeat step 2 for each adjustment that appears on the screen.
- Finish: **Function**.

ADVANCED FEATURES

TRANSMISSION

Transfer Request

Transfer Request helps you save costs when you send the same message to more than one place in a distant area. You send your message once, to a machine referred to as a Transfer Station. In turn, this machine sends on the message to local machines (referred to as End Receivers). After the Transfer Station has broadcasted the message to all End Receivers in the sequence, it sends your machine a Transfer Result Report to tell you if there were any problems with the communication.

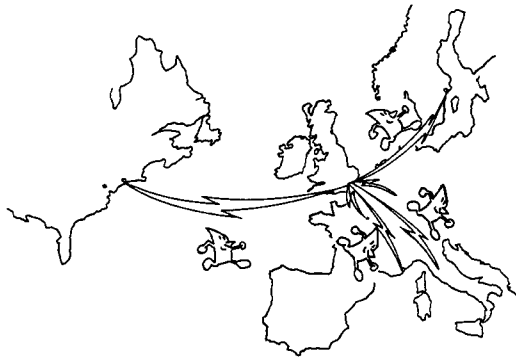

- Note:**
- This feature can only be used if the Transfer Station was made by the same maker as your machine.
 - The ID Code of your machine must be the same as the ID Code of the Transfer Station.
 - Your fax machine's telephone number must have been programmed in advance.
 - The Transfer Station must have memory space available, and must be able to act as a Transfer Station (some machines cannot do this, or can but the capability has been switched off).

You cannot specify the End Receivers as full numbers on your ten-key pad, and you cannot use your own stored Speed Dials, Quick Dials, and Groups. You must use the numbers that are stored as Quick Dials, Speed Dials or Groups in the Transfer Station. Always keep a copy of the Transfer Station's Telephone Lists (Quick Dial, Speed Dial, and Group Lists) near the machine if you plan to use Transfer Request.

Cross-reference:
 Quick Dial and Speed Dial: see pages 209 and 211. Groups: see page 210.
 ID Code: see page 52.

Before you can start to set up transfer request, there are some items that you have to program in your machine. These are as follows.

- Your Fax Machine's Own Telephone Number
- The ID Code

Storing your Machine's Own Telephone Number

Store your fax terminal's telephone number using this feature. If you do not do this, you will not be able to use the Transfer Request feature.

If your fax machine's telephone number changes, do not forget to change the stored telephone number data.

1. **Function 6 2 2 2 6 1.**

INITIAL MODE Y/NEXT▶
 61 INITIAL SET

2. **Yes.** Make sure that the opposite display appears, then press **Yes**.

Y/NEXT▶
 SET OWN NUMBER

3. Input your fax terminal's telephone number.

OWN NO. KPAD/Y/N
 0111212-5551234■■■■■

- The format of the number must be as follows:**
 International Dial Prefix, Your Country Code, Your Area Code, **then you must add a Pause**, followed by your telephone number.
 Check the International Dialing Prefix and the Country Code with your local telecommunications operator. The example shown is for the USA; the codes to add are 011 and 1.

Note: Use the **Pause** key to add a pause.

4. **Yes and Function.**

ADVANCED FEATURES

Storing the ID Code

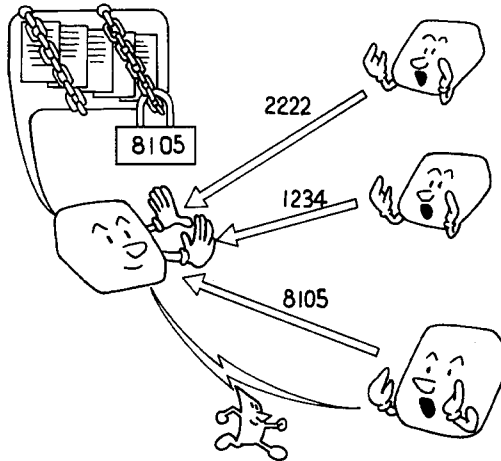

Before programming the ID Code, confer with other users in your fax network to agree on an ID Code. This is because communications using ID Codes will fail if the codes are not the same.

The ID Code can be any four-digit code (using digits 0 to 9 and letters A to F), except 0000 and FFFF.

In addition to the networking features described in this section, ID Codes are used with the following communication features. The same code must be used by all members of your fax network and all people you wish to communicate with using these features.

- Calling to Request a Message (Polling): see page 116.
- Closed Network: see pages 75 and 112.

Features using ID Codes can only be used between terminals made by the same maker.

Programming the ID code

To store an ID Code, do the following.

1. **Function 6 2 2 2 2 6 1 and Yes.**
2. Press ► until the opposite display appears.
3. **Yes.**
4. Input the ID Code that you will be using.
Example: **4 3 6 3**
 Do not use 0000 or FFFF.
5. **Yes and Function.**

Y/NEXT►
SET OWN NUMBER

Y/NEXT►
SET POLLING ID

POLLING ID KPAD
■■■■

POLLING ID Y/N
4363

Editing the ID Code

If you want to change the ID code, do the following.

1. **Function 6 2 2 2 2 6 1 and Yes.**
2. Press ► until the opposite display appears.
3. **Yes.**
4. **Yes and No.**
5. Input a new ID.
Example: **5433**
6. **Yes and Function.**

Y/NEXT►
SET OWN NUMBER

Y/NEXT►
SET POLLING ID

POLL. ID CHANGE? Y/N
1234

POLLING ID KPAD
■■■■

POLLING ID Y/N
5433

ADVANCED FEATURES

Making a Transfer Request

After you stored your Machine's Own Telephone Number and ID code you can do the transfer request as in the following procedure.

1. Make sure that the machine is in standby mode (see page 20).
2. Place your document in the feeder.

TRANSMIT OPTION►
DIAL FAX NUMBER

3. **Function 1 3** and **Yes**.

TRANSFER	OPTION▶
DIAL FAX NUMBER	

4. Input the telephone number of the transfer broadcasting station, then press **Yes**.

TRANSFER	*/KPAD
DESTINATION #■■■	

- This machine must be of the same manufacturer as yours, and it must be able to act as a Transfer Station.

5. Input the destinations for this transfer broadcaster. You must use Quick Dials, Speed Dials, or Groups that are stored in the transfer broadcaster. There is a shorthand notation for this purpose. See the following examples:

- Quick Dial Key 01: **0 1 Yes**
 Speed Dial Code 10: *** 1 0 Yes**
 Group 01: *** * 0 1 Yes**

Example: Speed Dial Code 10

TRANSFER	Y/N
DESTINATION ##10	

Note: You can select one Transfer Station, and up to 30 End Receivers for this Transfer Station.

6. **Yes**.

7. Either:

TRANSFER	*/KPAD
DESTINATION #■■■	

- Enter more destinations for this transfer broadcaster - go to step 5.
 Start the transfer request: **Start**.

Note: You may use some transmission options, such as Sending at a Specific Time. See page 34.

Programming Keystrokes

Overview

If you regularly transmit to a particular destination or set of destinations using the same features, you can save a lot of repetitive keypad operation by storing the features and destinations in a Keystroke Program.

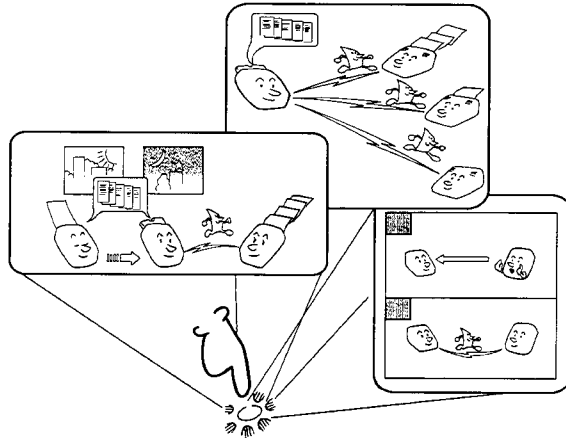

Keystroke Programs are stored as Quick Dial Keys.

- If you store a Keystroke Program into a Quick Dial Key, that Quick Dial Key cannot be used for any other purpose.
- Be sure to store your Keystroke Program in a vacant Quick Dial Key.

Example: Let us say that you normally send a daily report to locations A, B, and C at 11 pm (using Sending at a Specific Time). Store these instructions as a Keystroke Program. Then every day, you will only have to place the report in the document feeder, then press that key to set up the transmission.

Cross-reference:

Sending at a Specific Time: see page 34.

Storing a Keystroke Program

1. Make sure that the machine is in standby mode (see page 20).
2. Place a sheet of paper in the feeder.
 - Skip step 2 if you are making a Polling Reception program.
3. Select all required features (such as Transfer Request) and telephone numbers as you would normally do.
 - Contrast, resolution, and halftone cannot be stored in a keystroke program.
4. Press the Quick Dial key that you wish to store the program in.
Example: **01** of the Quick Dial
 - Make sure that this key is vacant.
5. To complete the program: **Yes**

READY	100% 10:00
SET DOC. OR DIAL NO.	

TRANSMIT	OPTION▶
DIAL FAX NUMBER	

PROGRAM	Y/N
PROGRAM?	

Note: The procedure that you just stored will now begin. If you do not wish to use the procedure now, press **Stop** immediately.

Labeling a Program

If you store a label for your keystroke programs, the label will appear on the display when you use the program.

1. **Function 3 4** and **Yes**.
If you press **▶** and Start, a Program List will be printed.

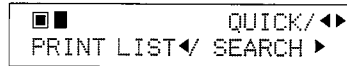

2. Press the Quick Dial key that holds the program that you wish to label.
Example: **01** of the Quick Dial Key and **Yes**.

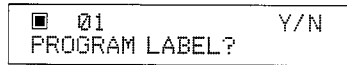

3. To program a label for this program; **Yes**.



4. Input your label, using the Quick Dial keys.

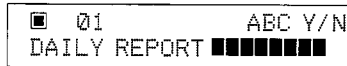

? How to enter the label; see page 182.

5. **Yes**.
6. Either:
 - Label another program: Go to step 2.
 - Return to standby: **Function**.

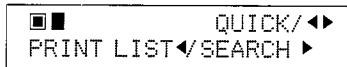

Using a Program

Before using a program, make sure that the machine is in standby mode (see page 20 for details).

Transmission Program

1. Place your document in the feeder.
2. Press the programmed Quick Dial Key.

```
TRANSMIT      OPTION▶  
DIAL FAX NUMBER
```

- The program begins at once, or at the later time specified by the program.

Free Polling Reception Program

1. Press the programmed Quick Dial Key.

```
2125551234  
SET DOC. OR DIAL NO.
```

- The program begins at once, or at the later time specified by the program.

Cross-reference: Picking Up Messages Stored Elsewhere (Polling Reception): see page 121.

Erasing a Program

When you wish to delete a keystroke program, do the following.

1. Function **3 4** and **Yes** .

```

           QUICK/◀▶
PRINT LIST◀/ SEARCH ▶
  
```

2. Press the Quick Dial key that holds the program that you wish to erase, or scroll the Quick Dial using ◀ and ▶.
Example: **08** of the Quick Dial Key.

```

 08 CHANGE?   Y/◀▶
USED AS PROGRAM
  
```

3. Press **Yes**.

```

 08          Y/N
PROGRAM LABEL?
  
```

4. **No**.

```

 08          Y/N
PROGRAM CLEAR?
  
```

5. To delete the program:**Yes** .

```

           QUICK/◀▶
PRINT LIST◀/ SEARCH ▶
  
```

6. Either:

- Edit or erase another program: Go to step 2.
- Return to standby: **Function**.

Sending Confidential Messages

Overview

This feature is called **Confidential Transmission**.

Use this feature if you do not want your message to be picked up casually by anybody at the other end. The message will be stored in the memory at the other end. It will not be printed until an ID known as the Confidential ID is entered.

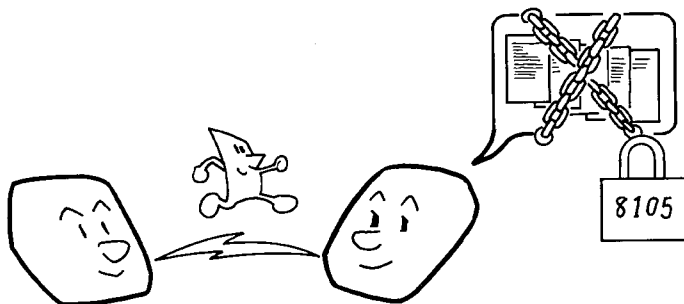

- Note:**
- The machine at the other end must have memory space available and it must have the Confidential Reception feature.
 - This is a proprietary feature, and as such it only functions with machines produced by the same manufacturer that have this feature.
 - Before sending a confidential message, it is recommended that you call the receiver and advise them that you are sending a fax message in this manner.

There are two types of Confidential Transmission.

1. Normal Confidential Transmission

The other party can print the message by entering the ID that was previously stored using the Confidential ID feature.

2. Confidential ID Override

If you wish to send a confidential message to a particular person at the other end, you can specify the Confidential ID that person has to enter to see that message. Anybody entering the machine's Confidential ID will not be able to see the message. Before you send the message, don't forget to tell the intended receiver what code must be entered to print the message.

Note: The receiving machine's Confidential ID is not changed by this process.

If the intended receiver has a Personal Code with a Confidential ID stored with it, you can override the receiving machine's ID with that Confidential ID. Then:

- The receiver can print the message by inputting the Confidential ID that is stored with that person's Personal Code.
- The intended receiver will also be informed personally by a Confidential File Report; this report will have the name of the receiver on it, if the name was stored with the Personal Code.

Cross-references:
 Confidential ID: see page 81. Personal Codes: see page 66.
 Confidential File Report: see page 138. Journal: see page 137.
 Receiving confidential Messages: see page 80.

Procedure

To set up a confidential transmission, do the following.

1. Place your document in the feeder.

TRANSMIT OPTION▶
 DIAL FAX NUMBER

2. **Function 1 2 and Yes.**

CONFID'L TRANS OPT▶
 DIAL FAX NUMBER

3. Dial then press **Yes.**

CONFID'L TRANS Y/STA
 2125551234 ■■■■■■■■■■

CONFID'L TRANS D/STA
 DIAL NEXT FAX NUMBER

4. Either:
 Dial another number: Go to step 3.
 Press **Start.**

ADVANCED
 FEATHER

Confidential ID Override Option

This procedure will override the Confidential ID stored in the other party's machine. The override is only effective for this one transmission.

If OPTION ▶ is displayed:

1. Press ▶ until the opposite display appears.

SET OPTION Y/▶
 SET CONFIDENTIAL ID?

2. **Yes.**

SET OPTION KPAD
 ID: ■■■■

3. Enter the Confidential ID that you wish to use for this message.
Example: **2 5 6 7** of the ten key pad and press **Yes**.

SET OPTION ID: 2567	Y/N
------------------------	-----

4. Dial and press **Start**.

Storing an Often Used Document (Auto Document)

Overview

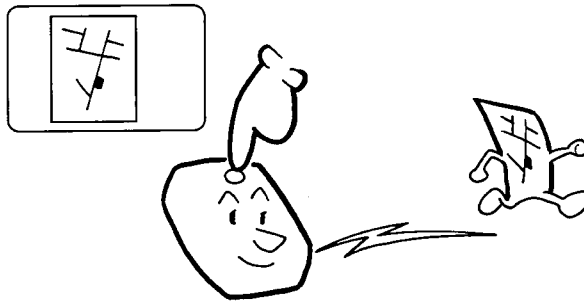

If you often find that you have to send a particular page to people (for example, a map, a standard attachment, or a set of instructions), store that page in the memory as an Auto Document, using a Quick Dial Key.

This feature is called **Auto Document**.

Then, when you need to send that page to somebody, press the Quick Dial Key that you stored it in, place any other pages that you wish to send into the feeder, dial, and press Start. At the other end, the Auto Document will be printed first.

You can also program a destination for each Auto Document into the same Quick Dial key.

The Auto Document is transmitted as is; you cannot write anything on it like you can with a cover sheet. If you wish the machine to place your name on your transmitted documents, try using the Label Insertion feature (see page 74).

Using an Auto Document

1. Make sure that the machine is in standby mode (see page 20).

2. If you wish to attach a fax message to your Auto Document, place the fax face down into the feeder.

```
TRANSMIT    OPTION ►
DIAL FAX NUMBER
```

3. Press the Quick Dial Key that contains the Auto Document that you need.
Example: **08** of the Quick Dial Key.

```
TRANSMIT    OPTION ►
OFFICE LOCATION MAP
```

4. Dial the destination(s), and press **Yes**.

```
TRANSMIT    DIAL/START
DIAL NEXT FAX NUMBER
```

5. Either;

Dial another number: go to step 4.

No more destinations: press **Start**.

Note: If you send the message to more than one location, and you enter the Quick key Dial which contain the Auto Document, it will be attached to all destinations.

Printing the Contents of an Auto Document

If you need to remind yourself of what one of your stored Auto Documents looks like, do the following procedure.

1. **Function 5 3** and **Yes**.

```
■ ■          QUICK/◀▶
PRINT LIST ◀/SEARCH ▶
```

2. Press the Quick Dial Key that holds the Auto Document that you wish to see.
Example: **08** of the Quick Dial Key and **Yes**.

```
■ 08        START/N
OFFICE LOCATION MAP
```

3. **Start**.

Erasing an Auto Document

If you wish to delete an Auto Document, do the following.

1. **Function 3 5** and **Yes**.

```

  QUICK/◀▶
PRINT LIST◀/SEARCH ▶
  
```

2. Press the Quick Dial Key that contains the Auto Document that you wish to erase.

```

 08 CHANGE? Y/◀▶
USED AS AUTO DOC.
  
```

Example: **08** of the Quick Dial Key.

3. **Yes**.

```

 08 Y/N
PROGRAM LABEL?
  
```

4. **No**.

```

 08 Y/N
AUTO DOC. CLEAR?
  
```

5. To erase the Auto Document: **Yes**.

```

  QUICK/◀▶
PRINT LIST ◀/SEARCH ▶
  
```

6. Either:

- Erase another Auto Document: Go to step 2.
- Return to standby mode: **Function**.

Restricting Access to the Machine

Overview

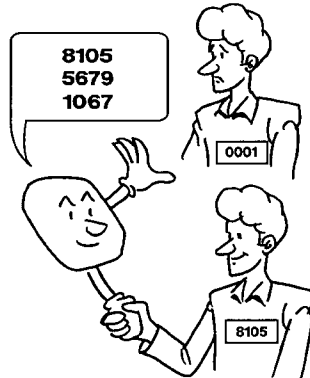

When your machine arrives from the factory and is installed for the first time, anybody can use it. However, using a system of Personal Codes, the machine can be set up to prevent unauthorized persons from using the machine. The necessary procedures are given in the following sections.

- Programming the Personal Codes: see below.
- Switching on Restricted Access: see page 69.

Programming the Personal Codes

The main advantage of Personal Codes is that they allow you to track machine usage and restrict access to the machine. If you do not wish to restrict access to the machine, you can still use Personal Codes to personalize your fax messages, by using the Label Insertion feature.

The Personal Code is a four digit code. It can have any value from 0001 to 9999.



Each user can be given a Personal Code. While programming, you can store the following items with each Personal Code:

- A name: This will be printed on reports, such as the JOURNAL, to identify the users of the machine.
- A Confidential ID: This must be different for each Personal Code, and different from your machine's Confidential ID. If somebody sends you a confidential message, they can override your machine's Confidential ID with the Confidential ID stored with your Personal Code, if you inform them of this ID. If so, the machine will print a Confidential File Report that will inform you when the message has arrived. Then, you must input this Confidential ID to print the message.

You can only store Confidential IDs if you have an optional feature expander.

Note: You cannot register more than 30 Personal Codes with Names and Confidential IDs in this machine. This means that if you switch Restricted Access on, only 30 people can use the machine.

Cross-references: Using Personal Codes: see pages 32, 61, 69, and 83.
 Journal: see page 137. Confidential File Report: see page 138.
 Confidential ID: see page 81. Receiving Confidential Messages: see page 80.

Storing a Personal Code

1. Function **6 2 2 2 2 7 2** and **Yes**.
2. **Yes**.
3. Input a Personal Code that you want to store in your machine for later use.
 Example: **5 4 7 7** from the ten key pad.
 If you input the wrong code, press **No**.
4. Store the code: **Yes**.
5. Either:
 - Yes** to store the label for this personal code.
 - If you do not program for this personal code; **No** and go to step 8.

SETTING? Y/◀▶
 PRINT LIST◀/SEARCH ▶

PERS. CODE KPAD/◀▶
 ■■■■

PERSONAL CODE Y/N
 5477

PERSONAL CODE Y/N
 PROGRAM LABEL? .

PERS. CODE ABC
 ■■■■■■■■■■■■■■■■■■■■

ADVANCED FEATURES

- 7. Either:
 - Edit the Confidential ID stored with this code; press **Yes** then input the ID.
When the ID is correct, press **Yes**.
- 8. Either:
 - Enter or edit another code: Go to step 2.
 - Finish: **Function**.

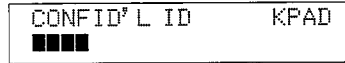

Switching Restricted Access On

Restricted Access allows you to keep a closer track of machine usage, and deters passers-by from casually using your machine.

If this feature is switched on, users have to enter their Personal Code before they can use the machine. The Personal Code must have already been stored in the machine.

However, the user can enter codes directly at the keypad. Therefore, if you are serious about using this feature to stop casual users from operating the machine, you must allocate relatively obscure codes to all authorized users, and try to avoid obvious numbers such as 0001.

To switch Restricted Access On or Off, do the following:

If you wish to switch Restricted Access on or off, do the following procedure. (See page 184 if you need more information about the User Parameter Settings adjustment procedure).

- 1. **Function 6 2 2 2 2 6 3** and **Yes**.

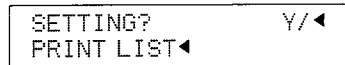

- 2. **Yes**.

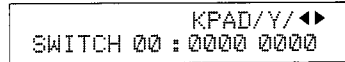

- 3. The settings for switch 00 are now shown on the bottom line of the display.
- 4. Press ▶ until the settings for switch 05 are shown. The setting that you need to change is digit 4.

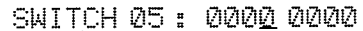

Digit 4 (Underlined)

Digit	Purpose		
4	Restricted Access	0: Off	1: On

- 5. If you wish to change the setting, press 4 on the ten key pad.
- 6. Finish: **Yes** and **Function**.

ADVANCED FEATURES

Operating the Machine with Restricted Access Switched On

If you have switched Restricted Access on, the display is as shown below when the machine is in standby mode.

Before you can use the machine, you must enter your personal code that you have already registered in the machine. See page 66 for how to store Personal Codes.

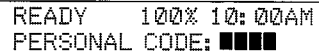

```
READY 100% 10:00AM
PERSONAL CODE: ■■■■
```

1. Enter your personal code.
Example: **7 3 6 2** from the ten key pad.
2. Press **Yes**. After a second, the normal standby display will appear, and you can use the machine. If the normal standby display does not appear, you entered a personal code that is not stored in the machine.

If you decide that you do not wish to use the machine now, you should return the machine to Restricted Access standby mode. To do this, either:

- Insert a page into the document feeder and remove it immediately.
Press **Function** twice.

Tonal Signals

On this model the * key on the ten keypad is used as the Tone key. Some organizations offer you a special service by telephone, which you can access by transmitting Touch tone or DTMF tones. If your phone service provides only pulse dialing, or if you are calling over a digital network, the ability to generate Tonal Signals will allow you to access these services. First, dial the other party when you are through to the other end, press the Tone key and enter the code number that is needed to access the required feature at the other terminal. You do not need to press the Tone key if your machine is set up for dialing in Tone Dial (DTMF) mode.

Using the Tone Key

- 1** Make sure that the machine is in standby mode, and that there is no document in the feeder.
- 2** Pick up the telephone handset.
- 3** Dial the remote facility. Do not press the **Start** key.
- 4** After your line is connected to the remote facility, do the following:
 - If your telephone line type is DTMF (Tone Dial): Go to step 5.
 - If your telephone line type is Pulse Dial: Press * on the ten keypad. A dot appears in the display.
- 5** Input the digits that you need to use the remote facility. After you have finished your business with the remote facility, hang up.
Note: Do not press the **Start** key.

Dialling with the Dial Option Key

1 Set the Document.

```
READY 100% 10:00AM
SET DOC. OR DIAL NO.
```

2 Enter the number.

```
TRANSMIT      Y/START
5551234
```

3 Press **Quick 29** and **Yes**.

```
TRANSMIT      Y/START
5551234S■■■■■■■■■■
```

4 Enter the subaddress.

```
TRANSMIT      Y/START
5551234S9999■■■■■■
```

5 Press **Quick 29** and **Yes**.

```
TRANSMIT      Y/START
5551234S9999P■■■■■■
```

6 Enter the selective polling ID.

```
TRANSMIT      Y/START
5551234S9999P1234■■
```

7 Press **Quick 29** and **Yes**.

```
TRANSMIT      Y/START
5551234S9999P1234W
```

8 Enter the password.

```
TRANSMIT      Y/START
5551234S9999P1234W23
```

9 Press **Quick 29** to enter space.

```
SPACE?                                Y/N
```

10 Either:
Press **Yes**. A space is entered.
Press **Quick 29** or **Yes**.

```
TRANSMIT      Y/START
51234S9999P1234W23
```

- Press **No** and **Yes**. You can enter the another fax number.

```
TRANSMIT      DIAL/START
DIAL NEXT FAX NUMBER
```

Note: You can program the password and sub-address in a Quick Dial, Speed Dial or Group. Quick 29 is programmed as Dial Option key.

Storing Part of a Number

This feature is called **Chain Dialing**.

It allows you to compose a telephone number from various parts, some of which may be stored as Quick Dial Keys or Speed Dial Codes, and some of which may be input at the keypad.

For example, you can program commonly used area or country codes into Speed Dial Codes or Quick Dial Keys.

This feature is convenient if:

- You often communicate with many terminals for which the area code, or international code is the same.
- You often make international calls.
For example, if you often call Tokyo, Japan, program 011813 (Overseas to Tokyo from the USA) as Quick Dial Key 01. This will save work at the operation panel when dialing a Tokyo number.
- Your PBX requires an ID code before the destination number.
For example, if your ID is 1234567, and the destination is stored in Quick Dial Key 01, enter 1234567 at the keypad, press Pause, then press Quick Dial Key 01.

Note: Do not store any Labels with the Quick Dials and Speed Dials that you are using with Chain Dialing. This is because Label Insertion does not work with Chain Dialing.

Cross-reference:

Quick Dial and Speed Dial: see page 209. Label Insertion: see page 74.

Example: 01133-1-5553333 (From the USA to Paris).

Assume that the following Quick Dial and Speed Dial numbers have already been programmed.

- Quick Dial 01 = 01133 (Overseas to France)
- Quick Dial 02 = 1 (Paris)
- Speed Dial 10 = 555

When the machine asks you to dial:

On Hook Dial or Handset Mode:

Press the **Quick Dial key 01**, next press the **Quick Dial key 02**. Then press the **Speed Dial key** and **1** then **0** using the ten keypad. After that press **3 3 3 3** using the ten keypad.

Other:

Press the **Quick Dial key 01** and **Pause**, **Quick Dial key 02** and **Pause**, then press the **Speed Dial key** and **1** then **0** using the ten keypad and then the **Pause**. After that press **3 3 3 3** using the ten keypad.

Printing Your Personal Identification at the Other End

This feature supplements the TTI. It uses the Personal Code and the Quick Dial or Speed Dial Label to inform the other party who is sending the message, and state who the message is for.

To use this feature, you must:

- Switch Label Insertion on for each Quick Dial and Speed Dial that you wish to use this feature with (see the procedures starting on pages 211 and 214).
- Program the Personal Codes of the machine's users, and store their names with their codes (see page 66).
- Program labels with the Speed Dial and Quick Dial numbers (see the procedures starting on pages 211 and 214).
- When you make a transmission, use a Quick or Speed Dial, and select the Personal Code option (see page 32).

Note: TTI off has effect on this feature.

Example: Your fax message as received at the other end

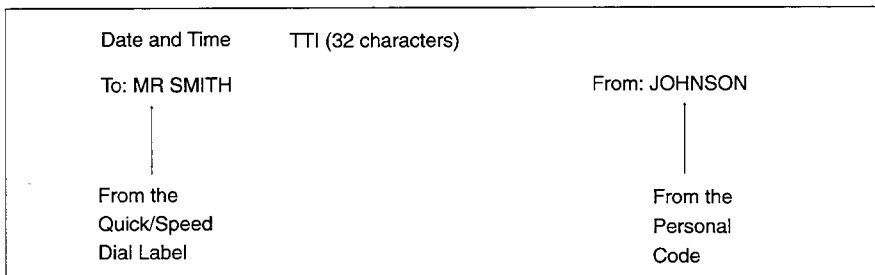

In the above example, the message was sent using Johnson's personal code. The Quick Dial or Speed Dial used to dial the destination had MR SMITH as the label.

Note: If you later reprogram the Speed/Quick Dial, be sure to reprogram or delete the label as well.

The top of the image will be overprinted if there is no margin at the top of the transmitted page (this is also true for the TTI.)

Cross-reference:

Quick Dial and Speed Dial: see page 209. Personal Codes: see pages 32 and 66.

Closed Network (Transmission)

This feature helps to stop you from accidentally sending a fax message to a terminal that is outside your fax network.

The ID Codes of the communicating machines are checked. If they are not the same, the communication is stopped.

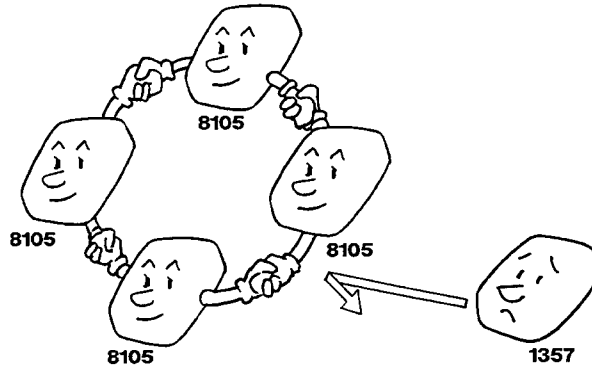

If you are interested in this feature, change the user parameter Switch 06 bit 2 to 1. (Function 63)

Note: This feature may not be reliable if you are communicating with a terminal produced by a different manufacturer.

Cross-references:

ID Code: see page 52.

Closed Network (Reception): see page 112.

Protection Against Wrong Connections

This feature prevents the automatic switching equipment in the telephone network from accidentally connecting you to the wrong fax terminal.

However, it does not help you if you dialed the wrong number yourself. So, even if this feature is switched on, you should still check your operation panel display to check whether you have reached the correct terminal, and be ready to press Stop if the wrong terminal's RTI or CSI is displayed.

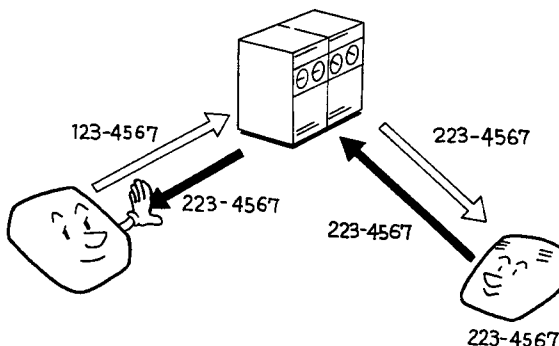

Your machine compares the number that you dialed with the CSI received from the other end. (Only the last 8 digits are checked, and spaces and pauses in the telephone number are ignored.) If the CSI is not the same as the telephone number, the transmission is stopped.

This feature has to be switched on by a service technician.

Note: If you cannot send a message to a certain location using this feature, contact the other end and make sure that they have stored their CSI correctly. (If the other party is using a machine made by another maker, they may not be familiar with the term CSI. Explain that you are interested in the telephone number that they stored in the machine for identification purposes.)

Cross-references: CSI: see pages 205 and 207.

ECM (Error Correction Mode) and Page Retransmission

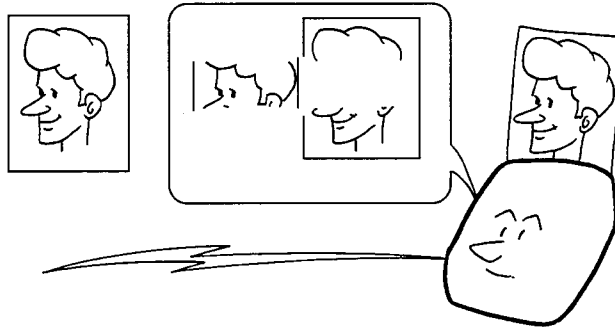

ECM is a signaling system that greatly reduces the chance of data being lost because of a bad telephone line. ECM is useful if you frequently communicate over poor telephone lines.

With ECM switched on, the communication cost will increase if the line is bad, but the data will be sent much more reliably.

If ECM is switched off, Page Retransmission will be used. The whole page will be resent (unless you used Immediate Transmission, in which case damaged data cannot be resent at all). ECM is more efficient, because it only resends the damaged parts of the data, and the maximum possible number of retransmission attempts is much higher, and it also works with Immediate Transmission.

If you prefer reliable communication over communication costs, keep ECM switched on. If you however prefer to be cost effective, ask the service technician to switch ECM off.

Pages can be sent up to 3 times before the machine gives up. If you wish to change the number of retries, contact a service technician.

ECM is switched on in your machine when it leaves the factory, to provide you with the ability to send accurate and complete documents as reliably as possible.

Batch Transmission

Overview

This feature will save communication costs if you often send more than one message to the same location.

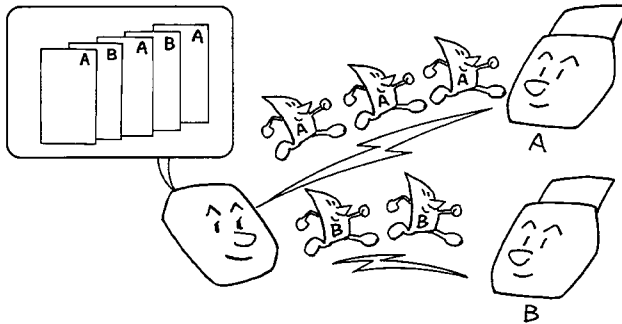

Example:

If various people in your office send messages to the Tokyo branch office, sending all these messages on separate calls can be expensive. It is cheaper to send them all together on the same call. You can further cut costs by sending out batches during off-peak hours. To do so, simply create Keystroke Programs that use Send Later to send to those common destinations.

Instruct people in your office to store all faxes for the Tokyo branch in the memory, using Send Later. The selected time of transmission must be the same for each message that you wish to include in the batch. Then, when that time comes, the messages will all be sent out on the same call, or 'batched'.

You can set up more than one batch. In the example shown in the diagram above, you have set up two batches; one is for destination A and one is for destination B. In another example, you could set up a batch for Tokyo at, say, 1 am, a batch for Hong Kong at 2 am, a batch for London at 3 am, and so on.

Also, when you send a fax message, if there is a message in the memory waiting for transmission to the same telephone number, it will be sent out with your message. This will only happen if the message already in the memory is waiting for retransmission (for example, because the line was busy on the first attempt).

Note: You can have up to 35 fax messages in the same batch.
Messages using Confidential Transmission cannot be put into a batch.

Cross-reference: Sending at a Specific Time: see page 34.

Changing the Batch Transmission On/Off

In a new machine, this setting is "On". If you wish to change this setting, use the following procedure. (See page 184 if you need more information about the User Parameter settings adjustment procedure).

1. **Function 6 2 2 2 2 6 3** and **Yes**.

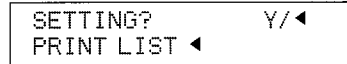

2. **Yes**.

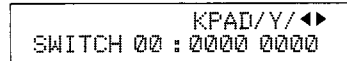

3. The settings for switch 00 are now shown on the bottom line of the display.
4. Press ▶ until the settings for Switch 06 are shown.
The setting that you need to change is digit 4.
5. If you wish to change the setting, press 4 of the ten key pad.
6. Finish: **Yes** and **Function** .

SWITCH06 : 0001 0000

Digit 4(Double Underlined)
0: Batch Transmission off
1: Batch Transmission on

Well Log Transmission

Using this feature, you can transmit a document that is longer than the maximum limit, without having to cut it up into separate sheets. However, you must contact a service technician to have this feature switched on. The name of this feature is taken from oil well borehole surveying. A well log is a vertical profile of a borehole, drawn to scale, showing important data. A well log can be several yards long.

ADVANCED FEATURES

CAUTION: If this feature is switched on permanently, users must stay by the machine while their documents are being scanned. This is because, if the document jams, the machine may take much longer than usual to recognize the jam; this could result in excessive wear and tear of the mechanical components of the scanner. If a jam does occur, press the Stop key immediately.

RECEPTION

Receiving Confidential Messages

Overview

This feature is called **Confidential Reception**.

If the other party sent you a message using Confidential Transmission, the message is stored in the memory, and not printed. The "Receive File" indicator on the operation panel blinks to inform you when a confidential message has come in. Also, if you have switched Confidential File Report on, the machine will print a report whenever a confidential message comes in.

There is no need to do anything immediately. When you want to print the message, input the Confidential ID.

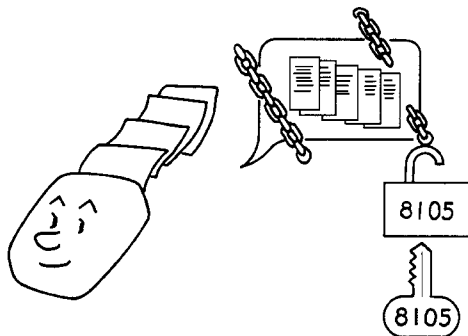

- Notes:**
- For this feature to work properly, you must have stored a Confidential ID in advance.
 - If the machine's Confidential ID does not have any effect, contact the sender and check whether they used Confidential ID Override to override your ID. Print the Journal to find out who the sender is, if necessary.
 - If you have forgotten the machine's Confidential ID, print a User Parameter List, or call a service technician for assistance.

Cross-references:

Confidential ID: see page 81.

Confidential File Report: see page 138.

Sending Confidential Messages: see page 60.

User Parameter List: see page 145.

Confidential ID Override: see page 60.

Journal: see page 137.

Storing a Confidential ID

This can be any four-digit code (using digits 0 to 9). It must be used to print any confidential messages that your machine has received.

1. **Function 6 2 2 2 6 1 and Yes.**

```

                                Y/NEXT▶
SET OWN NUMBER
    
```

2. Press ▶ until the screen is as shown opposite.

```

                                Y/NEXT▶
SET CONFIDENTIAL ID
    
```

3. **Yes.**

```

CONFID9 L ID      KPAD
■■■■
    
```

4. Input the Confidential ID that you will be using.

Example: **6 7 5 4** from the ten key pad.

```

CONFID9 L ID      Y/N
6754
    
```

5. **Yes and Function.**

If you do not store a Confidential ID, you will not be able to receive confidential messages.

Editing the Confidential ID

1. **Function 6 2 2 2 6 1 and Yes.**

```

                                Y/NEXT▶
SET OWN NUMBER
    
```

2. Press ▶ until the screen is as shown opposite.

```

                                Y/NEXT▶
SET CONFIDENTIAL ID
    
```

3. **Yes.**

```

CONF. ID CHANGE? Y/N
6754
    
```

4. **Yes.**

```

CONFID9 L ID      Y/N
6754
    
```

5. No and input a new confidential ID code
Example:8352.

```

CONFID9 L ID      Y/N
8352
    
```

6. **Yes and Function.**

ADVANCED FEATURES

Printing a Confidential Fax Message

If the Receive File indicator is blinking, do the following to print the message.

1. **Function 5 5** and **Yes**.

CONFID ⁷ L ID	KPAD
■■■■	

2. Input the ID. Example: **6 7 5 4** from the ten key pad.

CONFID ⁷ L ID	START/N
■■■■	

If you cannot output a confidential file with this ID, you have input the wrong ID or the sender may have over-ridden your ID.
Contact your sender.

3. **Start**.

Note: If the Receive File indicator is blinking, an incoming fax message has been stored in the memory using the Memory Lock feature or Confidential Reception feature.

To print the message which is Memory Locked, see page 87.

Confidential File Report

This report informs you when a confidential message has been received.

You can store a separate Confidential ID with each of the Personal Codes. If the sender of the message uses Confidential ID Override, the sender can specify one of these IDs. If so, the Confidential File Report will contain the name stored with that Personal Code, drawing the attention of the intended receiver of the confidential message.

You can switch this report on or off using Function 63. In a new machine, it is switched on at the factory.

1. **Function 6 2 2 2 6 3** and **Yes**.

```
SETTING?          Y/◀
PRINT LIST ◀
```

2. **Yes**.

```
          KPAD/Y/◀▶
SWITCH 00 : 0000 0000
```

3. The settings for switch 00 are now shown on the bottom line of the display.

4. Press ▶ until the settings for 04 are shown. The settings you need to change is digit 0.

```
SWITCH 04 : 0000 0000
```

Digit 0 (Double underlined)

0: Confidential file report is switched off.

1: Confidential file report is switched on

5. If you wish to change the setting press **0**.

6. Finish: **Yes** and **Function**.

Cross-reference: Personal Codes: see page 66.

If you wish, you can prevent unidentified senders from sending you Confidential Messages. See page 88.

ADVANCED FEATURES

Locking Incoming Messages (Memory Lock)

Overview

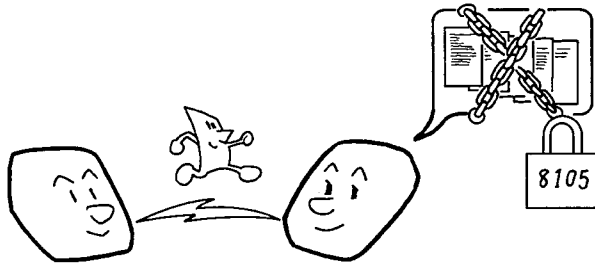

If Memory Lock is switched on, the machine will not print any incoming fax messages. They will be kept in memory until you enter the Memory Lock ID that you previously stored in the machine. Messages received by Confidential Reception will not be printed when you input the Memory Lock ID.

To use Memory Lock, you must first:

- Store a Memory Lock ID (Function 61).
- Switch Memory Lock on (Function 62).

To make Memory Lock more versatile you may choose to receive messages from select locations into memory or exclude certain select locations from coming into memory. You may:

- Specify the senders whose messages you want to be lock in memory (Special Terminals). Do this by programming the RTI's or CSI's of these senders (Function 81).
- Select the messages to store in memory (Function 63):
 - a) Only messages from Special Terminals.
 - b) All messages except those from specified Terminals.

Cross-reference:

Receiving Confidential Messages: see page 80.

Storing a Memory Lock ID

This can be any four-digit code (using digits 0 to 9), except 0000.

1. **Function 6 2 2 2 2 6 1** and **Yes**.

```

Y/NEXT▶
SET OWN NUMBER
  
```

2. Press ▶ until the screen is as shown opposite.

```

Y/NEXT▶
SET MEMORY LOCK ID
  
```

3. **Yes.**
4. Input the Memory Lock ID that you will be using. Example: **6 7 5 4** from the ten key pad.
5. Store the ID: **Yes** and **Function**.

LOCK ID	KPAD
■■■■	

LOCK ID	Y/N
6754	

Editing the Memory Lock ID

1. **Function 6 2 2 2 2 6 1** and **Yes.**
2. Press **▶** until the screen is as shown opposite.
3. **Yes.**
4. **Yes.**
5. **No** and input a new number.
6. **Yes** and **Function**.

SYSTEM SET	Y/NEXT▶
SET OWN NUMBER	

	Y/NEXT▶
SET MEMORY LOCK ID	

LOCK ID CHANGE?	Y/N
5477	

LOCK ID	Y/N
5477	

LOCK ID	Y/N
5478	

Switching Memory Lock On/Off

Before you can use Memory Lock, you have to switch it on using Function 62. After you switch Memory Lock on, (MEMORY LOCK) will appear on the display when the machine is in standby mode.

Note: If you switch Memory Lock on, Forwarding will be automatically disabled.

1. **Function 6 2 2 2 2 6 2** and **Yes.**
2. Scroll through the features with **▶** until the screen is as shown opposite.
3. **Yes.**
4. Change the on/off setting by pressing **◀** or **▶**.
5. Finish : **Yes** and **Function**.

SELECT LINE	Y/NEXT▶
-------------	---------

	Y/NEXT▶
MEMORY LOCK ON/OFF	

MEMORY LOCK	Y/◀▶
ON ▶OFF	

MEMORY LOCK	Y/◀▶
▶ON OFF	

If you wish, you can prevent unidentified senders from sending you messages while Memory Lock is on. See page 88.

Programming Special Terminals for Lock in Memory

If you like to receive information from only select locations into Memory lock, you can program the RTI codes or CSI codes of those locations. A terminal sending an incoming messages always identifies itself to your terminal. The identification consists of an RTI or a CSI. When you specify the senders for Memory lock, you must program a list of these codes. Program the list using Function 81 called "Special Terminals" (See page 133).

Selecting Which Messages to Lock in Memory

You have to select either to:

- Only Lock messages from Special Terminals.
- Lock all messages except those from Special Terminals.

1. **Function 6 2 2 2 2 6 3** and **Yes**.

At this time, you can print a User Parameter List if you press ◀ and **Start**.

```
SETTING?          Y/◀
PRINT LIST ◀
```

2. **Yes**.

```
                KPAD/Y/▶▶
SWITCH 00 : 0000 0000
```

3. The settings for switch 00 are now shown on the bottom line of the display.

4. Press ▶ until the settings for switch 09 are shown.

```
                KPAD/Y/▶▶
SWITCH 09 : 0000 0000
```

5. The setting that you need to change is that for digit 1 (Double underlined). Set as shown opposite.

When you want to lock incoming messages in memory from specified terminals;

```
SWITCH 09 : 0000 0001
```

If you lock all incoming messages except those from specified terminals;

```
SWITCH 09 : 0000 0011
```

6. Finish: **Yes** and **Function**.

List of Special Terminals (Function 81)	Memory Lock on/off (Function 62)	Switch 09 Digit7 (Function 63)	Result
Empty	On	Either	All messages are locked in memory.
Empty/Not empty	Off	Either	No messages are locked in memory.
Not empty	On	Listed	Only messages from special terminals are locked in memory.
Not empty	On	non-Listed	All messages are locked in memory except those from special terminals.

Printing a Memory-Locked Message

If the Receive File indicator is blinking, a message has been stored using Memory Lock. Print it using the following procedure.

1. **Function 56** and **Yes**.



2. Input the Memory Lock ID.
Example: **4 6 3 3** from the ten key pad.



3. **Start**.

Note: If the Receive File indicator is blinking, an incoming fax message has been stored in the memory using the Memory Lock feature or Confidential Reception feature.
To print the message using the Confidential Reception, see page 80.

ADVANCED FEATURES

Rejection of Messages from Unidentified Senders

If you wish, you can make the machine reject incoming messages that require storage to your machine's memory, if they are not accompanied with an identifier such as the RTI or CSI. Features that would be affected are Substitute Reception, Memory Lock, and Confidential Reception, Forwarding, and Action as a Transfer Station.

The procedure is as follows (see page 184 if you need more information about the User Parameter Settings adjustment procedure).

1. **Function 6 2 2 2 6 3** and **Yes**.

At this time, you can print a User Parameter List if you press ◀ and **Start**.

```
SETTING?          Y/◀
PRINT LIST ◀
```

2. Press **Yes**. The settings for switch 00 are now shown on the bottom line of the display.

```
          KPAD/Y/◀▶
SWITCH 00 : 0000 0000
```

3. Press ▶ until the settings for switch 05 are shown.

```
SWITCH 05 : 0000 0000
```

The setting that you need to change is that for digit 1.

Digit 1 (Double Underlined)
0: Messages are not rejected.
1: Messages are rejected.

4. If you wish to change the setting, press 1 on the ten key pad.

5. Finish: **Yes** and **Function**.

Cross-references:

Receiving Fax Messages When There Is a Problem (Substitute Reception):	see page 44
Receiving Confidential Messages:	see page 80
Lock Incoming Messages (Memory Lock):	see page 84
Forwarding:	see page 92

Authorized Reception

Overview

This feature helps you to reject junk fax mail. It lets you specify which terminals you wish to receive fax messages from; all others will be shut out.

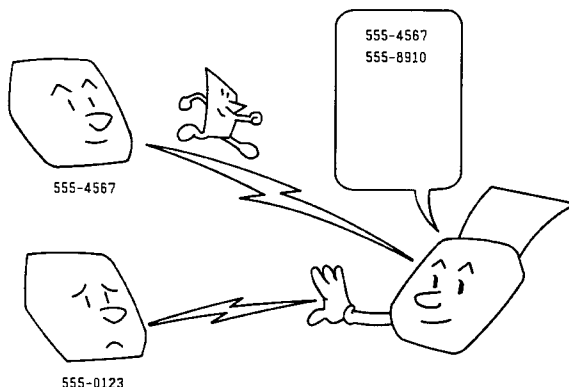

To authorize reception from a particular sender:

- Switch Authorized Reception on. (Function 62)
- Specify the senders whose messages you want accept (Function 81). Do this by programming the RTI or CSI of these senders. (Ask the sending party what their RTI/CSI is. Or make a communication with that terminal, print a Journal and read off the RTI/CSI.)
If the other party is using a machine made by another maker, they may not be familiar with the terms RTI or CSI. Explain that you are interested in the telephone number that they stored in the machine for identification purposes.
- Select the messages to accept (Function 63)
 - a) All messages from specified senders
 - b) All messages except those from specified senders.

If the RTI/CSI is not the same as any of those that you have programmed into this feature, the message will not be accepted.

The number of RTI/CSI's that you can store for use with this feature is limited to 30. However, you can use Wild Cards to extend the number of RTI/CSI's that you can specify.

Note: If you set the Authorized Reception on and you do not program any RTI or CSI of the sender, your machine do not accept any reception. If one of the authorized terminals changes their RTI/CSI, you have to change the stored RTI/CSI also. Otherwise, your machine cannot identify the senders as specified senders. So, you will not be able to accept messages from that sender any more under the current machine setting.

Cross-references:	RTI and CSI: see page 205.
Journal: see page 137.	Wild Cards: see page 102.

Switching Authorized Reception On/Off

Before you use Authorized Reception, you have to switch it on using Function 62. If it is switched off, the machine will accept any incoming fax message.

1. **Function 6 2 2 2 2 6 2** and **Yes**.

```
SELECT LINE          Y/NEXT▶
```

2. Scroll through the list of features with ▶ until the screen is as shown opposite.

```
AUTHORIZED ON/OFF  Y/NEXT▶
```

3. **Yes**.

```
AUTHORIZED          Y/◀▶
ON ▶OFF
```

4. Change the on/off setting by pressing ◀ or ▶.
5. Finish: **Yes** and **Function**.

Programming the List of the Senders for Authorized Reception

A terminal sending an incoming messages always identifies itself to your terminal. The identification consists of an RTI code or a CSI code. When you specify the senders for memory lock, you must program a list of these codes. Program the list by Function 81 called "Special Terminals" (See page 113).

Selecting Whether to Accept or Reject Messages from Special Terminals

You can select one of the following two things.

- Only accept messages from Special Terminals (i.e. reject all others).
- Accept incoming messages except those from the Specified Terminals (i.e. reject Special Terminals).

1. **Function 6 2 2 2 2 6 3** and **Yes**.

```
SETTING?           Y/◀▶
PRINT LIST◀
```

2. **Yes**.

The settings for switch 00 are now shown on the bottom line of the display.

```
KPAD/Y/◀▶
SWITCH 00 : 0000 0000
```

- 3. Press **▶** until the settings for switch 08 are shown.
The setting that you need to change is digit 3 (Double underlined).

```

KPAD/Y/◀▶
SWITCH 08 : 0000 0000
    
```

- 4. Set as shown opposite.
Press **3** on the ten key pad to change the setting of digit 3.

If you want to accept all incoming messages from the special terminals.

```

SWITCH 08 : 0000 0100
    
```

If you want to accept all incoming messages **except** those from the special terminals.

```

SWITCH 08 : 0000 0100
    
```

- 5. Finish: **Yes** and **Function**.

List of Special Terminals (Function 81)	Authorized Reception on/off (Function 62)	Switch 08 Digit 3 (Function 63)	Result
Empty	On	Either	No messages are accepted.
Empty/Not empty	Off	Either	All messages are accepted.
Not empty	On	Listed	Only messages from special terminals are accepted.
Not empty	On	non-Listed	All messages are accepted except from Special Terminals.

ADVANCED FEATURES

Forwarding

Overview

Using this feature, you can send fax messages coming in from certain locations on to another fax machine. The terminals that receive your forwarded messages are called "forwarding terminals".

If other fax machines in your organization have this feature, you can use Forwarding to set up distribution chains for incoming fax messages.

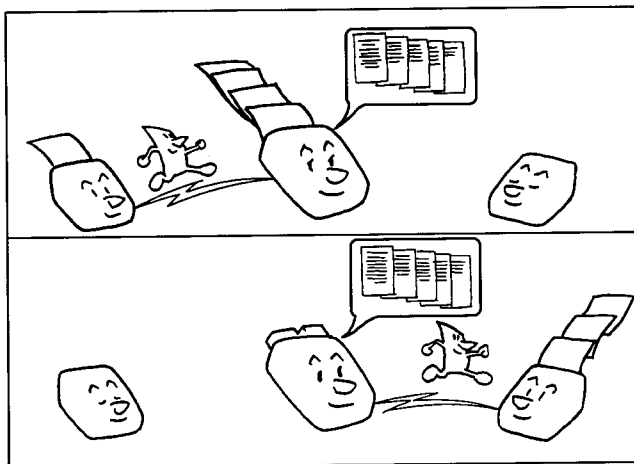

To set up Forwarding, program your machine as follows:

- Switch the Forwarding on (Function 62).
- Program the phone numbers of the Forwarding Terminals that you will pass on messages to, together with the list of specified senders for each number (Function 82).
- Specify the senders whose messages you want to forward (Ask the sending party what their RTI/CSI is. Or make a communication with that terminal, print a Journal and read off the RTI/CSI).
If the other party is using a machine made by another maker, they may not be familiar with the terms RTI or CSI. Explain that you are interested in the telephone number that they stored in the machine for identification purposes (Function 82).
- Select the messages to forward (Function 63):
 - a) All messages from specified senders.
 - b) All messages except those from specified senders.
- Decide whether you want your machine to automatically print messages that it forwards (Function 63).

5. Type in an RTI or CSI.
How to enter characters, see page 7.

```
RTI/CSI      ABC Y/N
XYZ COMPANY ██████████
```

6. **Yes.**

```
RTI/CSI      Y/N
STORE AS WILD CARD?
```

7. Either:
 Store this RTI as a wild card: **Yes**
 Otherwise: **No**

```
FORWARD      Y/N
SET RTI/CSI?
```

8. Either:
 If you want to store another RTI/CSI,
press **Yes** and go to step 5.
 Otherwise: **No** and go to step 9.
9. Either:
 Store another forwarding station; go
to step 3.
 Finish; **Function**.

```
FORWARD      KPAD/◀▶
████████████████████
```

Editing the Forwarding Feature

1. **Function 6 2 2 2 2 8 2** and **Yes**.

```
SETTING?      Y/◀▶
PRINT LIST ◀/SEARCH ▶
```

2. Press ▶ until the forwarding station number you wish to edit appears. Then press **Yes**.

```
FORWARD      KPAD/Y/N
2125551234 ██████████
```

3. Either:
 Erase this forwarding station's number and all RTIs/CSIs stored with it: Press **No**, then **Yes** to erase. Then press **Function**.

```
FORWARD      Y/N
SET RTI/CSI?
```

- If you change the forwarding station's telephone number; Edit this forwarding station's telephone number and press **Yes**. Then go to step 4.

```
FORWARD      KPAD/Y/N
2125552234 ██████████
```

- If this forwarding station's telephone number is correct: **Yes**. Go to step 4.

```
FORWARD      Y/N
SET RTI/CSI?
```

4. Either:
 If you change the RTI/CSI; **Yes** and go to step 5.
 If you don't change the RTI/CSI; **No** and go to step 2 to edit another forwarding number. (If you finish editing, press **Function**)

```
RTI/CSI      ABC ◀▶
████████████████████
```

5. Either:
 To add RTIs/CSIs to this number: Input an RTI/CSI and press **Yes**. Then go to step 7.

```
RTI/CSI   ABC Y/N
XYZ COMPANY
```

- To edit RTI's/CSI's allocated to this number: press **▶** until the RTI/CSI you wish to edit appears. Then press **Yes**. Go to step 6.

```
RTI/CSI CHANGE? Y/◀▶
XYZ COMPANY
```

6. Either:
 Edit the RTI/CSI and press **Yes**. Then go to step 7.
 To delete the RTI/CSI: **No** and **Yes**. Then go to step 5.

```
RTI/CSI   Y/N
STORE AS WILD CARD?
```

CAUTION: If you delete all the RTIs and CSIs for a forwarding station, you must also delete the forwarding station (see step 3).
If you do not do this, all incoming messages will be forwarded to that station.

7. To store it as a wild card: **Yes**.
 Otherwise: **No**.

```
FORWARD   Y/N
SET RTI/CSI?
```

8. Either:
 Edit or input another RTI/CSI for this forwarding station: Press **Yes** and Go to step 3.
 To work on another forwarding station: press **No**. Go to step 2.
 Finish: **Function**.

Note: If you switch the forwarding on and program no RTI/CSI, all incoming messages are forwarded.

ADVANCED FEATURES

Switching Forwarding On/Off

Before you use Forwarding, you have to switch it on using Function 62. If it is switched off, the machine will not forward any incoming fax messages.

After you switch Forwarding on, (FORWARD) is displayed on the operation panel when the machine is in standby mode.

Note: Forwarding cannot be switched on if Memory Lock is switched on. If you wish to use Forwarding, you must switch Memory Lock off.

1. **Function 6 2 2 2 6 2** and **Yes**.

```

SELECT LINE          Y/NEXT▶
  
```

2. Scroll through the list of features with ▶ until the screen is as shown as opposite.

```

FORWARDING ON/OFF  Y/NEXT▶
  
```

3. **Yes**.

```

FORWARDING          Y/◀▶
ON      ▶ OFF
  
```

4. Change the on/off setting by pressing ◀ or ▶.

5. Finish: **Yes** and **Function**.

Selecting which messages to forward

You have to select one of the following two things.

Forward all incoming messages from specified senders.

or

Forward all incoming messages except those from specified senders.

1. **Function 6 2 2 2 2 6 3** and **Yes**.

```
SETTING?          Y/◀
PRINT LIST◀
```

2. **Yes**.

The settings for switch 00 are now shown on the bottom line of the display.

```
                KPAD/Y/◀▶
SWITCH 00 : 0000 0000
```

3. Press ▶ until the settings for switch 08 are shown.
The setting that you need to change is digit 7 (Double underlined).

4. Set as shown opposite.

Press **7** of the ten key pad to change the setting of digit 7.

If you want to forward all incoming messages from special terminals.

```
SWITCH08 : 0100 0000
```

If you want to forward all incoming messages except those from special terminals.

```
SWITCH08 : 1100 0000
```

5. Finish: **Yes** and **Function**.

ADVANCED FEATURES

Switching Local Printing On/Off

When you first switch Forwarding on, messages that your machine passes on are not printed by your machine. If you turn this function on however, they will be printed.

1. Press **Function** and **6 2 2 2 2 6 3** using the ten keypad, then press **Yes**.
2. Press **Yes**, then press **◀** and **▶** until the settings for Switch 11 are displayed. Change the setting of digit 6.
3. If you wish to change the setting, press **6** using the ten keypad.
4. Finish: Press **Yes**, then press **Function**.

```
SETTING?      Y/◀▶
PRINT LIST ◀
```

```
                KPAD/◀▶
SWITCH 11: 0000 0000
```

```
SWITCH 11 : 0100 0000
Digit 6 (Double underlined)
0: Local Printing Off
1: Local Printing On
```

Enabling and Disabling the Forwarding Mark



The forwarding mark is printed at the receiving end on the top of each page of the fax messages that are forwarded from your machine. This mark will help the operator at the other end to recognize messages that have been forwarded. If you wish, you can switch this mark off.

To switch the Forwarding Mark on or off, do the following procedure. (See page 184 if you need more information about the User Parameter settings adjustment procedure).

1. **Function 6 2 2 2 2 6 3** and **Yes**.
2. **Yes**.
The settings for switch 00 are now shown on the bottom line of the display.
3. Press **▶** until the settings for switch 02 are shown.
The setting that you need to change is digit 0.
4. If you wish to change the setting, press **0** of the ten key pad.
5. Finish: **Yes** and **Function**.

```
SETTING?      Y/◀▶
PRINT LIST◀
```

```
                KPAD/Y/◀▶
SWITCH 00 : 0000 0000
```

```
SWITCH02 : 0000 0000
Digit 0 (Double Underlined)
0: Forwarding Mark is Off
1: Forwarding Mark is On
```

Specified Cassette Selection (Optional Lower Cassette Required)

Overview

This feature is only available if your machine has the Lower Cassette. Using this feature, you can select fax messages from certain senders to be printed from a specified cassette.

Example:

Put yellow paper in the specified cassette. Then, messages from the head office can be printed out on yellow paper; this will make it easy for you to see when a message from head office has arrived.

To direct messages from a particular sender to a special cassette:

- Specify the senders you want to print from the specified cassette (Function 62). Do by this by programming the RTI's or CSI's as Special Terminals. (Ask the sending party what their RTI/CSI is. Or make a communication with that terminal, print a JOURNAL, and read off the RTI/CSI.)
If the other party is using a machine made by another maker, they may not be familiar with the terms RTI or CSI. Explain that you are interested in the telephone number that they stored in the machine for identification purposes.
- Switch Specified Cassette Selection on. (Function 62)
- Select the specified cassette. (Function 38; Printer Interface Required)
- Select which messages to print using paper from the specified cassette:
 - a) Only messages from special terminals.
 - b) All messages except those from Special Terminals.

Note: If one of the senders changes their RTI/CSI, you have to change the stored RTI/CSI also. Otherwise, messages from that sender will no longer be sent to the required cassette.

Cross-references:	Journal: see page 137.
RTI and CSI: see page 205.	Wild Cards: see page 102.

- Note:**
- Messages from senders that have RTI/CSIs that match those that were input using the above procedure will be printed using the specified paper cassette.
 - First of all, you must programming Special Terminals for cassette selection. (Function 81)

Switching Cassette Selection On or Off

Before you can print messages from specified cassette, you have to switch it on using Function 62.

1. **Function 6 2 2 2 2 6 2** and **Yes**.

SELECT LINE	Y/NEXT▶
-------------	---------

2. Scroll through the list of features with ▶ until the screen is as shown opposite.

CASSETTE	Y/NEXT▶
	ON/OFF

3. **Yes**.

CASSETTE SELECT	Y/◀▶
ON ▶OFF	

4. Change the on/off setting by pressing ◀ or ▶.

CASSETTE SELECT	Y/◀▶
▶ON OFF	

5. Finish: **Yes** and **Function**.

Programming the Special Terminals for Cassette Selection

To program the list of senders, see "Entering a List of Senders to Treat Differently (Function 81, Special Terminals)" on page 113.

Choosing How to Treat the Special Terminals

You have to select one of the following two things

- Only messages to print using paper from the specified cassette or
- All messages except those from special terminals.

1. **Function 6 2 2 2 2 6 3 and Yes.**

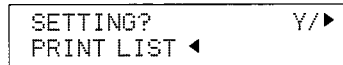

2. **Yes.**

The settings for switch 00 are now shown on the bottom line of the display.

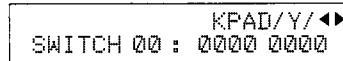

3. Press > until the settings for switch 08 are shown.

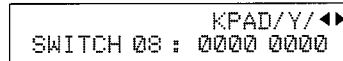

The settings that you need to change is digit 5 (Double underlined). Press 5 of the ten keypad to change the setting of digit 5.

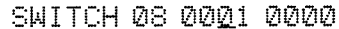

When you want to print fax messages from special terminals using the main cassette.

4. Choose the setting you need (see opposite).

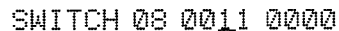

When you want to print fax messages except those from special terminals using the main cassette.

5. Finish: **Yes and Function.**

List of Special Terminals (Function 81)	Specified Cassette Seledction (Function 62)	Switch 08 Digit 5 (Function 63)	Result
Empty	On	Either	Print all incoming fax messages using specified cassette.
Empty/Not empty	Off	Either	Print all incoming fax messages using normally used cassette.
Not empty	On	Listed	Print Special Terminals' messages using the main cassette, but don't print any others with the cassette.
Not empty	On	non-Listed	Don't print Special Terminals' messages using the main cassette, but print all others with the cassette.

ADVANCED FEATURES

Wild Cards

This feature greatly enhances the effectiveness of the following features:

- Authorized Reception
- Forwarding
- Memory Lock
- Multi Copy
- Specified Cassette Selection

In each of these features, you have to store the RTI or CSI of various terminals that you normally receive fax messages from. Then, when your machine detects an incoming call, it checks the RTI or CSI of the other terminal, and acts accordingly.

When you program RTI's for these features, you can program wild cards to greatly expand the number of terminals that you can specify.

Example: If you wish to accept messages from all 150 branches of XYZ Company (using Authorized Reception), and forward them on to head office (using Forwarding), you don't have to store the RTI of each branch of XYZ Company. Program "XYZ" as a wild card for each of these functions. If the RTIs of all XYZ branches contain an "XYZ" somewhere in the RTI, messages coming in from them will be accepted, and sent on to head office.

CAUTION: This feature cannot recognize spaces.

Example: If you store MAN as a wild card, and a terminal with an RTI that includes MANCHESTER, HUMAN, or HUMANE calls you, your machine will recognize MAN as a wild card and accept and/or forward the message.

Cross-references: Authorized Reception: see page 89. Forwarding: see page 92.
RTI and CSI: see page 205.

Reverse Order Printing

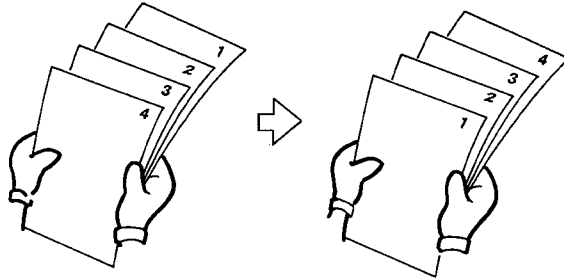

Normally, the machine prints the pages of received messages in the order that they were received uncollated.

However, with Reverse Order Printing, the machine will collate the sequence by printing the message from the last page first collated. This will make it easier to distribute the received fax messages, and more convenient for reading them.

Reverse Order Printing will not take place unless you switch it on beforehand.

To switch this feature on or off, do the following procedure. (See page 184 if you need more information about the User Parameter Settings adjustment procedure).

1. **Function 6 2 2 2 6 3** and **Yes**.
2. **Yes**. The settings for switch 00 are now shown on the bottom line of the display.
3. Press **▶** until the settings for switch 10 are shown.
4. The setting that you need to change is digit 0 (Double underlined).
5. If you wish to change the setting, press **0** of the ten key pad.
6. Finish: **Yes** and **Function**

```
SETTING?          Y/◀
PRINT LIST ◀
```

```
                KPAD/Y/◀▶
SWITCH 00 : 0000 0000
```

```
                KPAD/Y/◀▶
SWITCH 10 : 0000 0000
```

```
SWITCH 10 : 0000 0001
```

Digit 0 (Double underlined)
 0: This feature is Off.
 1: This feature is On.

ADVANCED FEATURES

Multi-sort Document Reception

Using this feature, more than one copy of each incoming fax message can be printed. You may also choose to have more than one copy from only select senders. This feature eliminates the extra steps needed to have someone make photocopies.

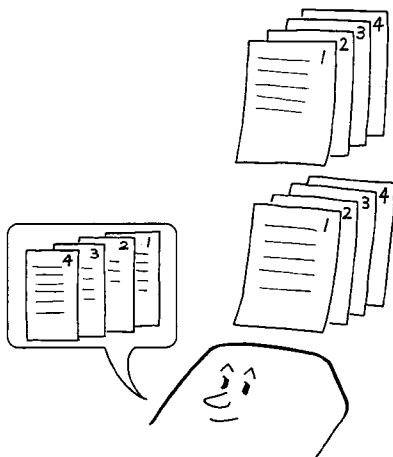

For example, if you switch this feature on overnight, you will not have to make distribution copies of the messages that came in during the night. However, the paper in the cassette will be used up much faster.

To use Multi-sort Document Reception, you must first:

- Switch Multi-sort on (Function 62).
- Set the number of copies (Function 83).
- Switch Reverse Order Printing on (See page 103).

If you wish to specify the senders whose messages are multi sorted.

- Specify the senders whose messages you want to make Multi-sort . Do this by programming the RTI or CS of these senders (Function 81).
- Select the messages to Multi-sort copied (Function 63):
 - a) All messages from Special Terminals.
 - b) All messages except those from Special Terminals.

Cross-reference:

Reverse Order Printing: see page 103.

Copying an Original: see page 136.

Switching Multi-sort Document On or Off

Before you can make multiple copies, you have to switch it on using Function 62

1. **Function 6 2 2 2 2 6 2** and **Yes**.

```
SELECT LINE      Y/NEXT▶
```

2. Scroll through the list of features with ▶ until the screen is as shown opposite.

```
# OF COPIES ON/OFF      Y/NEXT▶
```

3. **Yes**.

```
# OF COPIES      Y/◀▶  
ON ▶OFF
```

4. Change the on/off setting by pressing ◀ or ▶.

```
# OF COPIES      Y/◀▶  
▶ON  OFF
```

5. Finish: **Yes** and **Function**

Setting the Number of Copies

1. **Function 6 2 2 2 2 8 3** and **Yes**.

```
NO. OF COPIES  KPAD/Y  
1 SETS
```

2. Input the number of copies that you need, then press **Yes** .
Copies of incoming faxes will be col-
lated.

```
NO. OF COPIES  KPAD/Y  
3 SETS
```

Note: Maximum number of copies: 9.
To use Multi-sort Document Reception, you must switch Reverse Order Printing on. see page 103 for how to do this.

3. **Function**.

Programming the Special Terminals to Make Multi-sort-copies

To program the list of senders, see "Entering a List of Senders to Treat Differently (Function 81 Special Terminals)" On page 113.

Choosing How to Treat the Special Terminals

You have to select one of the following two things

- Make multiple copies of messages from Special Terminals
- or
- Make multiple copies of all messages except those from Special Terminals.

ADVANCED FEATURES

1. **Function 6 2 2 2 2 6 3** and **Yes**.

```
SETTING?      Y/◀
PRINT LIST◀
```

2. **Yes**.

The settings for switch 00 are now shown on the bottom line of the display.

```
          KPAD/Y/◀▶
SWITCH 00 : 0000 0000
```

3. Press ▶ until the settings for switch 08 are shown.

The setting that you need to change is digit 1 (Double underlined).

Press 1 of the ten key pad to change the setting of digit 1.

```
          KPAD/Y/◀▶
SWITCH 00 : 0000 0000
```

```
SWITCH08 0000 001
```

When you want to make multiple copies of all incoming messages from Special Terminals.

4. Set as shown opposite.

```
SWITCH 08 0000 0011
```

When you want to make multiple copies of all incoming messages except those from Special Terminals

5. Finish: **Yes** and **Function**.

List of Special Terminals (Function 81)	Multi-sort on/off (Function 62)	Swith 08 Digit 1 (Function 63)	Result
Empty	On	Either	All messages are Multi-sorted.
Empty/Not empty	Off	Either	No messages are Multi-sorted.
Not empty	On	Listed	Only messages from special terminals are Multi-sorted.
Not empty	On	non-Listed	All messages are Multi-sorted except those from Special Terminals.

Printing a Center Mark

If you switch this feature on, a mark is printed halfway down each received page on the left hand side. This makes it easy for you to position the hole puncher correctly when you file away the received fax messages.

The center mark is not printed when you use the machine for making copies.

To switch this feature on, do the following. (See page 184 if you need more information about the User Parameter settings adjustment procedure).

1. **Function 6 2 2 2 6 3** and **Yes**.

```
SETTING?      Y/◀
PRINT LIST ◀
```

2. Press **Yes**. The settings for switch 00 are now shown on the bottom line of the display.

```
                KPAD/Y/▶▶
SWITCH 00 : 0000 0000
```

3. Press **▶** until the settings for switch 02 are shown. The setting that you need to change is digit 1 (Double underlined).

```
                KPAD/Y/▶▶
SWITCH 02 : 0000 0000
```

```
SWITCH02 : 0000 0010
```

Digit 1(Double underlined)
 0: The center mark will not be printed
 1: The center mark will be printed

4. If you wish to change the setting, press 1 on the ten key pad.
5. Finish: **Yes** and **Function**.

Checked Mark

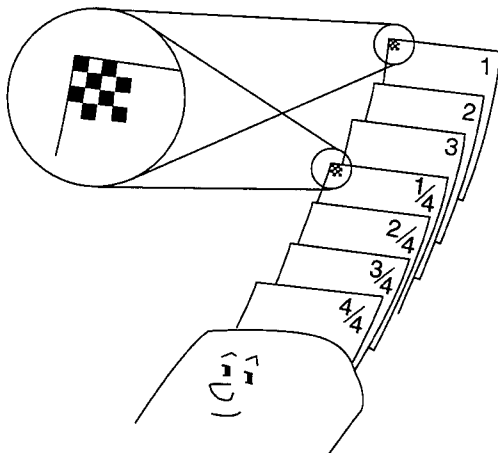

The machine prints a checkered mark in the top left corner of the first page of received messages. Using this mark, you can find the first page easily. This makes it easier for you to separate the messages that are lying in the copy tray.

To switch this feature on or off, do the following. (See page 184 if you need more information about the User Parameter Settings adjustment procedure).

1. **Function 6 2 2 2 6 3** and **Yes**.

```
SETTING?      Y/◀
PRINT LIST ◀
```

2. Press **Yes**. The settings for Switch 00 are now shown on the bottom line of the display.
3. Press **▶** until the settings for Switch 02 are shown.

```
                KPAD/Y/◀▶
SWITCH 00 : 0000 0000
```

```
                KPAD/Y/◀▶
SWITCH 02 : 0000 0000
```

The setting that you need to change is digit 4 (Double underlined).

```
SWITCH02 : 0001 0000
```

Digit 4 (Double underlined)

0: The Checkered Mark will not be printed.

1: The Checkered Mark will be printed.

4. If you wish to change the setting, press **4** on the ten keypad.
5. Finish: **Yes** and **Function**.

Reception Time

When you receive a message, the time is printed at the bottom of the page. However, this is the time at the transmitting end or printing end. To check the local time, you have to print the Journal.

However, if you switch on Reception Time, the local time is also printed at the bottom of on each page that you receive. The time is taken from your machine's internal clock, and is the same as the time that will be printed on the Journal. Switch this feature on if you often receive fax messages from other countries.

Cross-references:

Journal: see page 137.

Date and Time: see page 204.

To switch this feature on, do the following. (See page 184 if you need more information about the User Parameter Settings adjustment procedure).

1. **Function 6 2 2 2 2 6 3** and **Yes**.

```
SETTING?      Y/◀
PRINT LIST ◀
```

2. Press **Yes**. The settings for switch 00 are now shown on the bottom line of the display.

```
          KPAD/Y/◀▶
SWITCH 00 : 0000 0000
```

3. Press **▶** until the settings for switch 02 are shown.

```
          KPAD/Y/◀▶
SWITCH 02 : 0000 0000
```

The setting that you need to change is digit 2 (Double underlined).

```
SWITCH02 : 0001 0100
```

Digit 2 (Double underlined)
 0: The Reception Time will not be printed.
 1: The Reception Time will be printed.

4. If you wish to change the setting, press **2** on the ten keypad.
5. Finish: **Yes** and **Funciton**.

Two in One (Into 1)

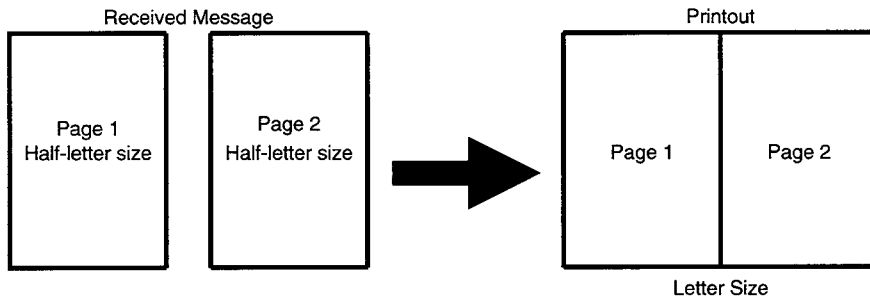

This feature helps you conserve paper. If the size of the incoming page is half the size of the paper in the cassette, the machine will print out two pages on one sheet of paper.

In the example shown above, somebody is sending your machine two sheets of half-letter sized paper and your machine is printing them out on one letter sized sheet.

Note: If the sender specifies different resolution, contrast or halftone settings for each page, these will not show up using this feature.

To switch this feature on, do the following. (see page 184 if you need more information about the User Parameter Settings adjustment procedure).

1. **Function 6 2 2 2 2 6 3** and **Yes**.

```
SETTING?      Y/◀
PRINT LIST ◀
```

2. Press **Yes**. The settings for switch 00 are now shown on the bottom line of the display.
3. Press **▶** until the settings for switch 10 are shown.

```
          KPAD/Y/◀▶
SWITCH 00 : 0000 0000
```

```
          KPAD/Y/◀▶
SWITCH 10 : 0000 0000
```

The setting that you need to change is digit 1 (Double underlined).

```
SWITCH10 : 0000 0010
```

Digit 1 (Double underlined)
0: Two in One is disabled.
1: Two in one is enabled.

4. If you wish to change the setting, press **1** on the ten keypad.
5. Finish: **Yes** and **Function**.

Reducing the Page Length

If the machine receives a page that is longer than the paper in the cassette, the machine reduces the length of the received image so that it will fit on one page, if the image length is within the following limits.

Paper size in the cassette	Maximum reducible incoming page length
Letter (11")	14.4"
Legal (14") (for option cassette)	15.7"

If the received image is longer than the above limits, there is no reduction and the image is split up and printed on two sheets of paper. Normally, the last 0.4 inch of the received image will be repeated at the beginning of the next page.

However, if you wish, the second page can continue from where the first page ended.

Contact your service representative if you require any adjustments to this feature.

Closed Network (Reception)

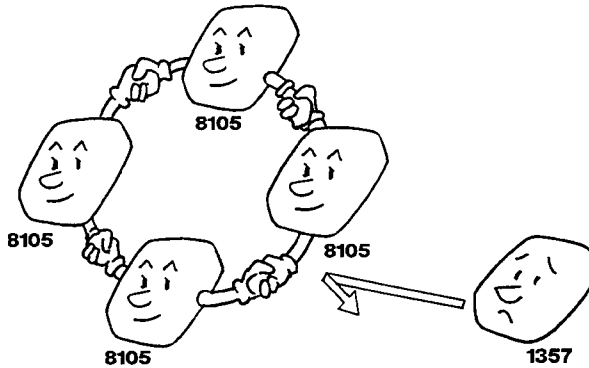

This feature may help you to prevent reception of excessive junk fax mail.

The ID Codes of the communicating machines are checked. If they are not the same, the communication is stopped.

Note: This feature may not be reliable if you are communicating with a terminal produced by a different manufacturer.

If you are interested in this feature, contact your service representative.

Cross-references: ID Codes: see page 52.

Free Manuals Download Website

<http://myh66.com>

<http://usermanuals.us>

<http://www.somanuals.com>

<http://www.4manuals.cc>

<http://www.manual-lib.com>

<http://www.404manual.com>

<http://www.luxmanual.com>

<http://aubethermostatmanual.com>

Golf course search by state

<http://golfingnear.com>

Email search by domain

<http://emailbydomain.com>

Auto manuals search

<http://auto.somanuals.com>

TV manuals search

<http://tv.somanuals.com>