

SAVIN

9027/9027L/9027DL

Operating Instructions

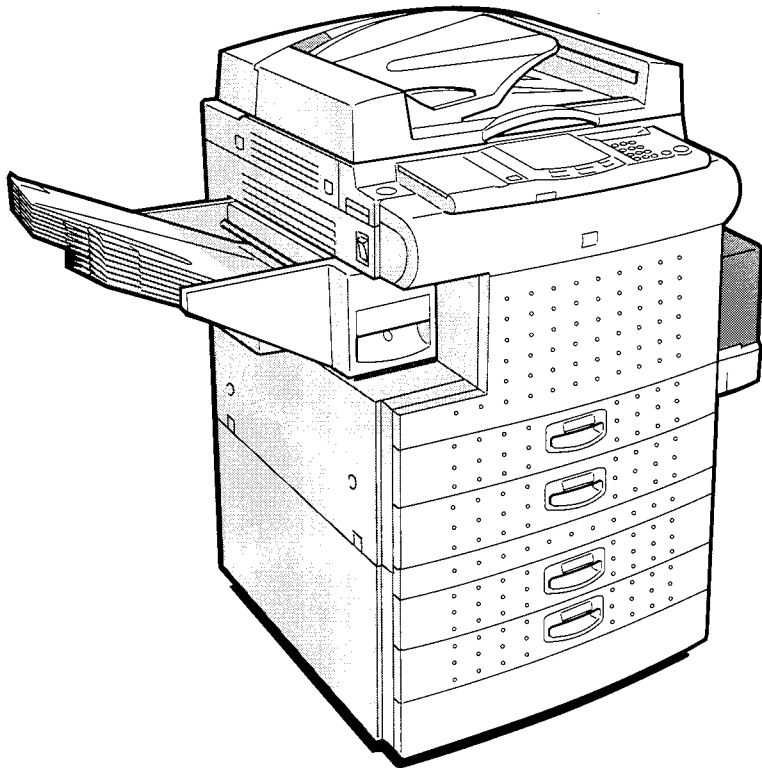

Notes: The model names of the machines do not appear in the following pages. Check the type of your machine before reading this manual.
(For details, see page 2.)

Basic	: 9027
With 1000-sheet large capacity tray	: 9027L
With 1000-sheet large capacity tray and unit for two-sided copying	: 9027DL

Certain types may not be available in some countries. For details, please contact your local dealer.

For good copy quality, Savin recommends that you use genuine Savin toner.

Savin shall not be responsible for any damage or expense that may result from the use of parts other than genuine Savin parts in your Savin office product.

Note: Some illustrations may be slightly different from your machine.

Note: Certain options may not be available in some countries. For details, please contact your local dealer.

Power Source: 120 V, 60 Hz, more than 12A
Please make sure to connect the power cord to a power source as above.
For details about power source, see page 148.

INTRODUCTION

This manual contains detailed instructions on the operation and maintenance of this copier. To get maximum versatility from this copier, all operators should carefully read and follow the instructions in this manual. Please keep this manual in a handy place near the machine.

Please read the next section before using this copier. It contains important information related to USER SAFETY and PREVENTING EQUIPMENT PROBLEMS.

SAFETY INFORMATION

When using your copier, the following safety precautions should always be followed.

Safety During Operation

In this manual, all safety messages are identified by the words "WARNING" and "CAUTION". These words mean the following:

WARNING: Important information to alert you to a situation that might cause serious injury and damage to your property if instructions are not followed.

CAUTION: Important information that tells how to prevent damage to equipment, or how to avoid a situation that might cause minor injury.

WARNINGS:

Since some parts of the copier are supplied with high electrical voltage, touch only the parts specified in this manual.

Do not modify or replace any parts other than the ones specified in this manual.

Do not incinerate toner or toner containers. Toner dust might ignite when exposed to open flames.

Do not store toner where it will be exposed to heat.

Do not eat or swallow toner, and keep it out of reach of children.

The fusing section can be very hot. Be careful when handling it.

CAUTIONS:

While copying, do not turn off the main switch.

While copying, do not open the front cover.

While copying, do not lift the platen cover, or the optional document feeder.

While copying, do not unplug the power cord.

Do not lay anything weighing more than 22 lb on the exposure glass.

Do not place tools or other hard objects on the exposure glass.

Keep corrosive liquids, such as acid, off the machine.

Do not allow paper clips, staples, or other small metallic objects to fall inside the machine.

General Safety Information

- Always turn the copier off when you have finished copying for the day, but leave it plugged in.
- When the copier will not be used for a long period, disconnect the power cord.
- If the copier must be transported by vehicle, please contact your service representative.
- When the main switch is in the Stand-by position, the optional anticondensation heaters are on. In case of emergency, unplug the machine's power cord.
- To disconnect the power source, the main plug must be pulled.

TABLE OF CONTENTS

WHERE IS IT & WHAT IS IT

MODELS.....	2
OPTIONS.....	3
COPIER EXTERIOR AND INTERIOR	4
PAPER TRAYS	6
OPERATION PANEL	8
Keys 1	
Basic & With 1000-sheet Large Capacity Tray.....	8
Indicators 1	
Basic & With 1000-sheet Large Capacity Tray.....	10
Keys 2	
With 1000-sheet Large Capacity Tray And	
Unit For Two-sided Copying	12
Indicators 2	
With 1000-sheet Large Capacity Tray And	
Unit For Two-sided Copying	14

WHAT YOU CAN DO WITH THIS COPIER

FUNCTIONS	18
HINTS	26

SETTING ORIGINALS

ORIGINALS	30
Recommended Originals.....	30
Non-recommended Originals For The Optional Document Feeder	30
SETTING ORIGINALS ON THE EXPOSURE GLASS	31
SETTING A STACK OF ORIGINALS IN THE OPTIONAL DOCUMENT FEEDER.....	32
SETTING ONE ORIGINAL AT A TIME IN THE OPTIONAL DOCUMENT FEEDER.....	34

COPYING

STARTING THE COPIER	38
When The Main Switch Is In The Stand-by Position	38
When The Energy Saver Indicator Is On	39
When The Copier Is Set For User Codes	39
FREQUENTLY USED FUNCTIONS	40
One-to-one Copying	40
Adjusting Copy Image Density	41
Having The Copier Choose The Paper Size (Auto Paper Select)	42
Having The Copier Choose The Reproduction Ratios (Auto Reduce/Enlarge)	44
Copying From The Bypass Feed Table.....	45
Temporarily Stopping One Job To Copy Something Else (Interrupt Copying)	47
Reducing And Enlarging.....	49
Entering Copy Job Settings During The Warm-up Period (Auto Start)	53
MAKING ONE-SIDED COPIES FROM VARIOUS ORIGINALS (Single Copies).....	54
From 2 One-sided Originals To 1 One-sided Copy (Combine Originals) ...	54
From 1 Two-sided Original To 2 One-sided Copies (2 Sided Original)	56
From 2 Facing Pages To 2 One-sided Copies (Book Original).....	57
ADDING OR INSERTING SHEETS (Cover/Slip Sheet)	59
Copying The Front Cover Of The Originals (Copy Cover).....	59
Copying The Front And Back Covers Of The Originals.....	60
Adding A Front Cover Sheet (Blank Cover)	62
Adding Front And Back Cover Sheets.....	63
Inserting Slip Sheets Between OHP Transparencies (OHP Slip Sheet)	64
ERASING PARTS OF THE COPY IMAGE (Erase).....	66
Erasing The Center Margin Of The Original Image (Erase Center)	66
Erasing The Surrounding Area Of The Original Image (Erase Border)	66
Erasing The Center Margin And Surrounding Area Of The Original Image	66

ADDING MARGINS FOR BINDING (Margin Adjustment)	68
Margin For One-sided Copying.....	68
Margin For Two-sided Copying.....	69
STORING YOUR COPY SETTINGS IN MEMORY (Program)	70
Storing Your Settings	70
Protecting Your Settings From Being Overwritten	71
Recalling Your Settings.....	71
Unprotecting Your Settings	72
MAKING TWO-SIDED COPIES (ONLY WITH MODEL HAVING THIS FEATURE)	73
From An Even Number Of One-Sided Originals (1 Sided Originals, even)	73
From An Odd Number Of One-Sided Originals (1 Sided Originals, odd)	74
From Two-Sided Originals (2 Sided Original)	75
From Facing Pages (Book Original)	76
FINISHING (OPTION)	77
Sorting Into Sets (Sort).....	77
Stapling Copies (Staple)	78
Stacking Together All Copies Of A Page (Stack)	82
COPYING WITH USER CODES	84
SAVING ENERGY	85
COMBINATION CHART	86
WHAT TO DO IF SOMETHING GOES WRONG	
IF YOUR COPIER DOES NOT OPERATE AS YOU WANT	90
IF YOU CANNOT MAKE COPIES AS YOU WANT	94
 IS LIT: LOADING PAPER	95
Non-recommended Paper For Paper Trays.....	95
Notes For Paper	95
Loading Paper In The 250-sheet or 500-sheet Tray	96

Loading Paper In The Large Capacity Tray (only with models having this tray)	97
IS LIT OR BLINKING: ADDING TONER.....	98
IS LIT: ADDING STAPLES.....	99
If Your Copier Is Equipped With The 20-bin Sorter Stapler	99
If Your Copier Is Equipped With The 10-bin Sorter Stapler	100
IS LIT: CLEARING MISFEEDS	101
Check The Misfeed Location Display	101
When A, B, C, Y, Or Z Is Lit:	102
When R Is Lit:	102
When P Is Lit (Original Misfeed):	104
REMOVING JAMMED STAPLES	105
If Your Copier Is Equipped With The 20-bin Sorter Stapler	105
If Your Copier Is Equipped With The 10-bin Sorter Stapler	106
CHANGING THE COPIER'S SETTINGS	
CHANGING PAPER SIZE.....	108
Paper Trays.....	108
Copier's 250-sheet Trays	110
Optional 500-sheet Or 1000-sheet Paper Tray Unit And Bypass Feed Table	113
USER TOOLS.....	118
How To Access User Tools.....	118
How To Change Adjustment Values Or Modes	119
User Tool Menu	121
SERVICE REPRESENTATIVE SETTING.....	139

**MAINTAINING YOUR COPIER
DO'S AND DON'TS
WHERE TO PUT YOUR COPIER
REMARKS
USE AND STORAGE OF SUPPLIES**

MAINTAINING YOUR COPIER..... 144

DO'S AND DON'TS..... 146

WHERE TO PUT YOUR COPIER..... 147

REMARKS..... 149

USE AND STORAGE OF SUPPLIES..... 151

SPECIFICATIONS

COPIER 154

DOCUMENT FEEDER (OPTION) 157

20-BIN SORTER STAPLER (OPTION) 158

10-BIN SORTER STAPLER (OPTION) 159

20-BIN SORTER (OPTION) 160

10-BIN SORTER (OPTION) 160

500-SHEET TRAY UNIT (OPTION) 161

1000-SHEET TRAY UNIT (OPTION) 161

WHERE IS IT & WHAT IS IT

WHERE IS IT & WHAT IS IT

Basic

Two 250-sheet trays

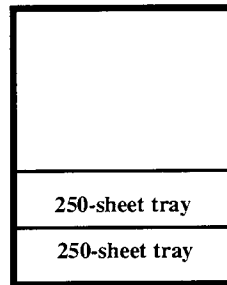

With 1000-sheet large capacity tray

Two 250-sheet trays
A 1000-sheet large capacity tray

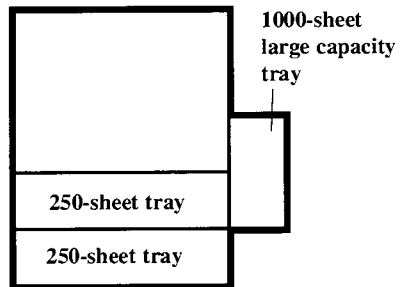

With 1000-sheet large capacity tray and unit for two-sided copying

A 250-sheet tray
A 1000-sheet large capacity tray
A unit for two-sided copying

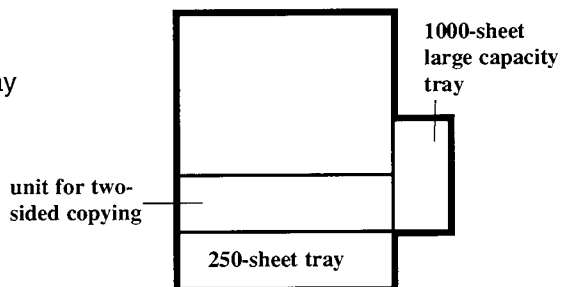

OPTIONS

WHERE IS IT & WHAT IS IT

This copier can be provided with the following options:

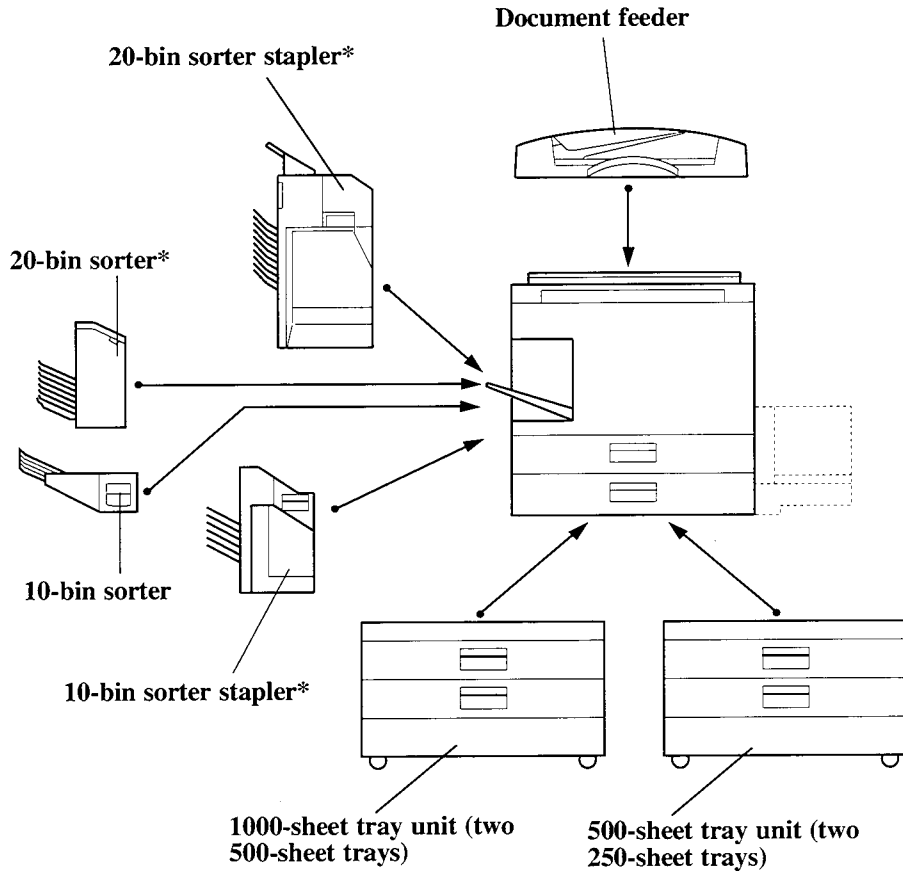

Other options: Platen cover (in some areas), key counter

*These options require the optional sorter adapter.

COPIER EXTERIOR AND INTERIOR

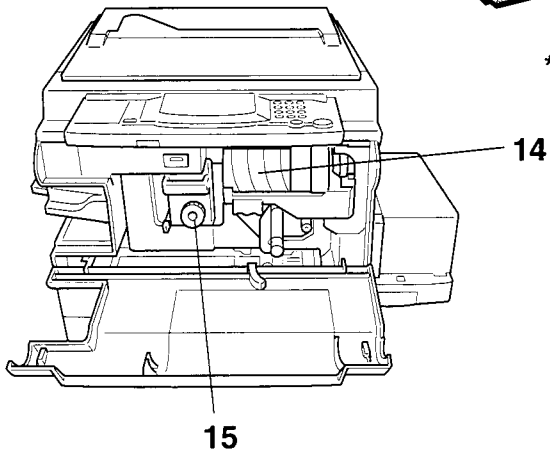
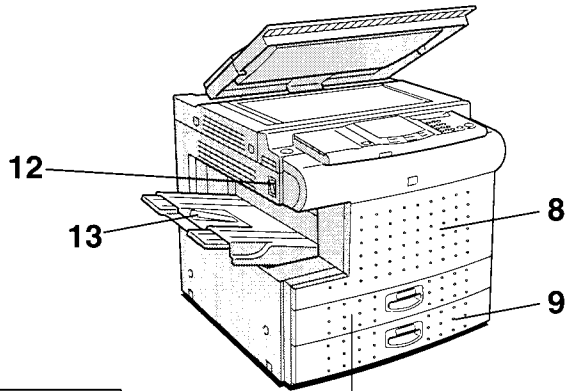
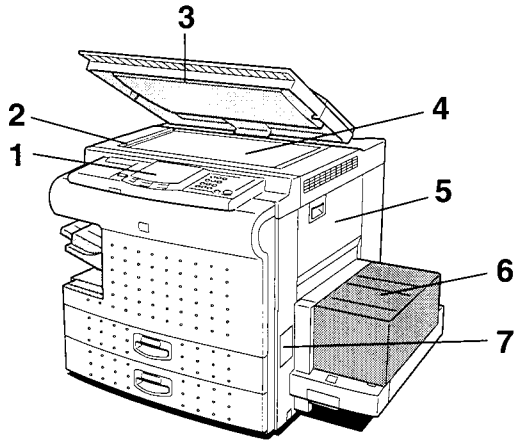

1. **Operation panel** Operator controls and indicators are located here.
2. **Left scale** Use to align originals on the exposure glass.
3. **Platen cover**
(option in some areas) Lower this cover over originals for copying.
4. **Exposure glass** Position originals here face down for copying.
5. **Bypass feed table** Use to copy onto OHP sheets, adhesive labels, translucent paper, and post cards.
6. **1000-sheet large capacity tray** This tray can hold 1,000 sheets of copy paper. Two of three models have this tray. (☛ See page 2.)
7. **Key counter holder** Insert the optional key counter here.
8. **Front cover** Open to access the inside of the copier.
9. **250-sheet tray** This tray can hold 250 sheets of copy paper.
- *10. **250-sheet tray** This tray can hold 250 sheets of copy paper. The model with a unit for two-sided copying does not have this tray. Instead, it has the unit for two-sided copying (*11).
- *11. **Unit for two-sided copying** This unit is used to make two-sided copies.
12. **Main switch** Switches the copier between on and stand-by conditions. ("stand-by" means that the anticondensation heaters are on.)
13. **Copy tray** Completed copies are delivered here.
14. **Toner Bottle** Replace the toner bottle when the  **Add Toner** indicator is lit or blinking.
15. **Fusing Unit** Fuses the copy image to the paper. When accessing the inside of the copier, use caution. This unit may be very hot.

PAPER TRAYS

Each 250-sheet or 500-sheet tray's name changes depending on what kind of copier and optional paper tray unit you have. Find your copier among the illustrations below and on the next page. Then, when you find paper tray's name (ex. 1st tray) in this manual, confirm which paper tray is pointed in the case of your copier.

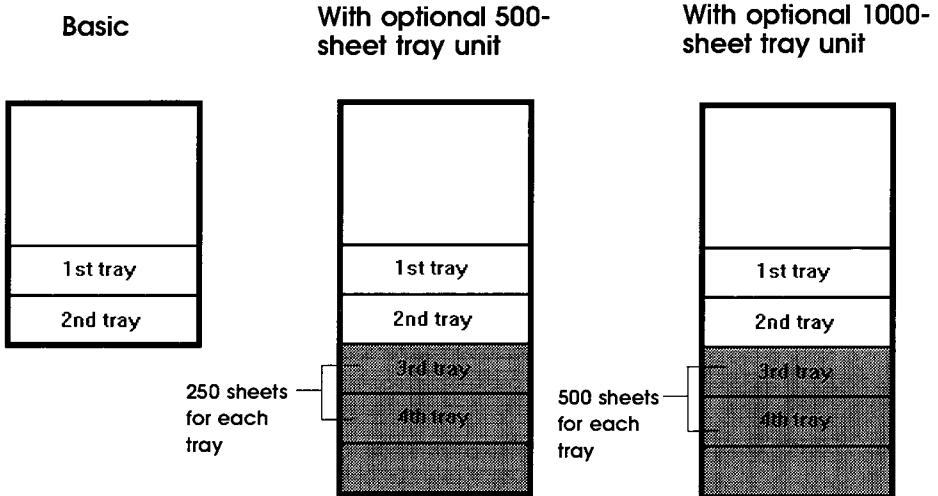

With large capacity tray

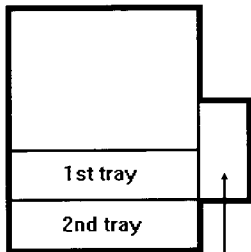

large capacity tray (LCT)

With large capacity tray and optional 500-sheet tray unit

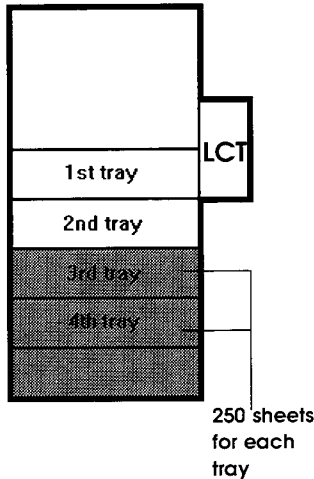

With large capacity tray and optional 1000-sheet tray unit

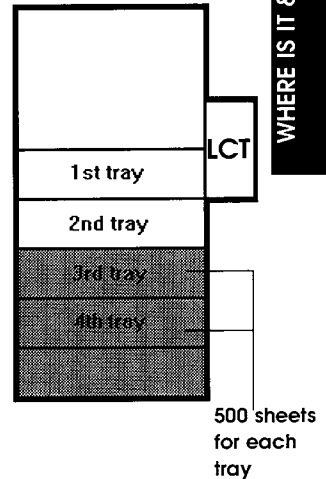

WHERE IS IT & WHAT IS IT

With large capacity tray and unit for two-sided copying

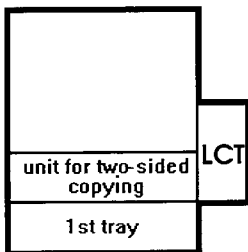

With large capacity tray, unit for two-sided copying, and optional 500-sheet tray unit

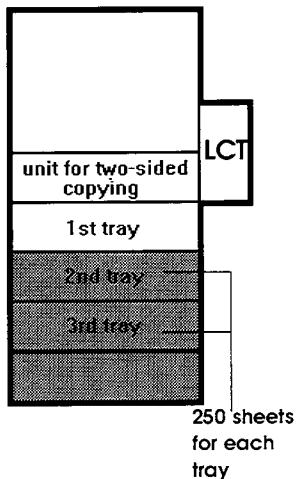

With large capacity tray, unit for two-sided copying, and optional 1000-sheet tray unit

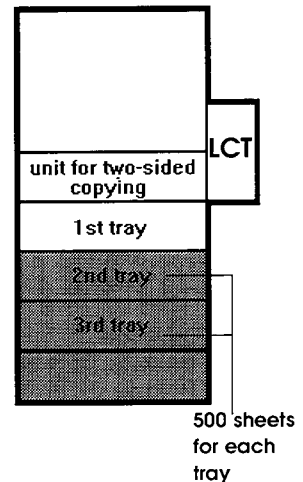

OPERATION PANEL

Keys 1

Basic & With 1000-sheet Large Capacity Tray

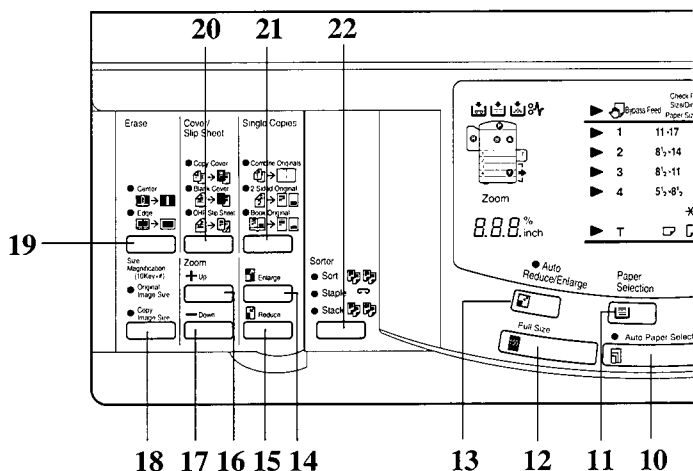

1. **Program key** See page 70.
2. **Clear Modes/Energy Saver key**
Press to clear the copier of previously entered settings. Press this key for more than 1 second to enter/exit the Energy Saver mode. See pages 39 and 85.
3. **Interrupt key** See pages 47 and 48.
4. **Recall/Enter key**
Use to enter data.
5. **Start key**
Press to start copying.
Use to set the Auto Start.
 See page 53.
6. **Clear/Stop key**
Press to cancel the copy number entered. While copying, press to stop copying. This key is also used to clear data.
7. **Number keys**
Use to enter the desired number of copies. They are also used to enter data.
8. **Lighter and Darker keys**
 See page 41.
9. **Auto Image Density key**
 See page 41.
10. **Auto Paper Select key**
 See page 42.

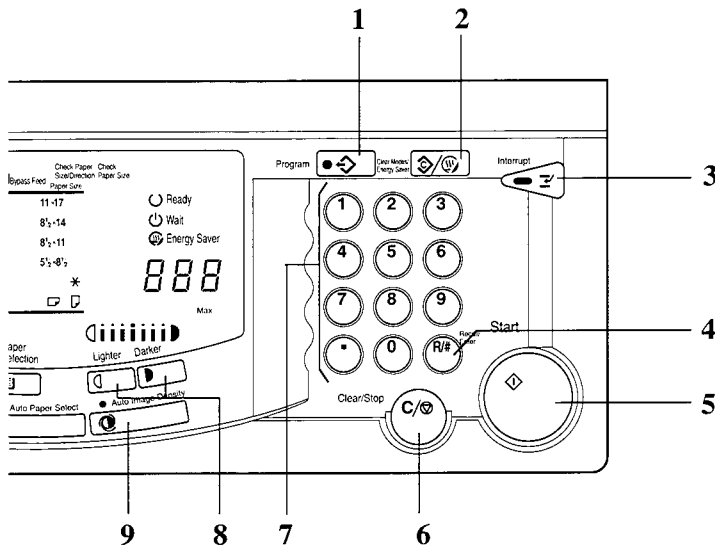
**11. Paper Selection key**

☛ See page 40.

12. Full Size key

☛ See page 40.

13. Auto Reduce/Enlarge key

☛ See page 44.

14. Enlarge key

☛ See page 49.

15. Reduce key

☛ See page 49.

16. Zoom Up key

Enlarges in 1% steps. ☛ See page 50.

17. Zoom Down key

Reduces in 1% steps. ☛ See page 50.

18. Size Magnification key

Copier sets the magnification for your paper and original sizes. ☛ See page 51.

or

10 Key Zoom key ☛ See page 50.

19. Erase key

☛ See page 66.

or

Margin Adjustment key
☛ See page 68.

20. Cover/Slip Sheet key

☛ See pages 59 ~ 65.

21. Single Copies key

☛ See pages 54 ~ 58.

22. Sorter key (option)

☛ See pages 77 ~ 83.

Indicators 1

Basic & With 1000-sheet Large Capacity Tray

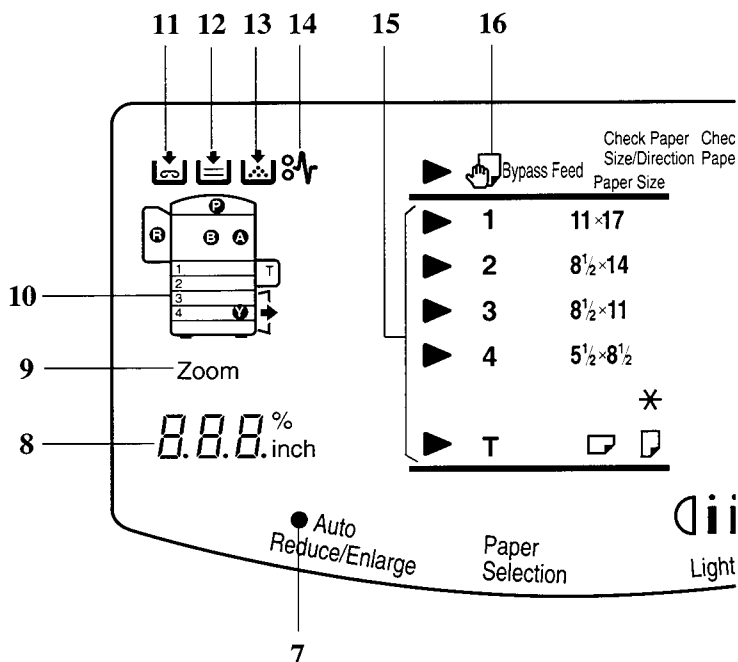

1. **Ready indicator** ☛ See page 38.
2. **Wait indicator** ☛ See page 38.
3. **Energy Saver indicator**
☛ See pages 39 and 85.
4. **Copy Counter**
Indicates the number of copies.
Data display. ☛ See pages 91 and 118.
5. **Max indicator** ☛ See page 93.
6. **Manual Image Density indicator**
☛ See pages 41 and 93.
7. **Auto Reduce/Enlarge indicator**
☛ See page 44.
8. **Three Digit indicator**
Data display.
9. **Zoom indicator**
Lights when you use the Zoom function.

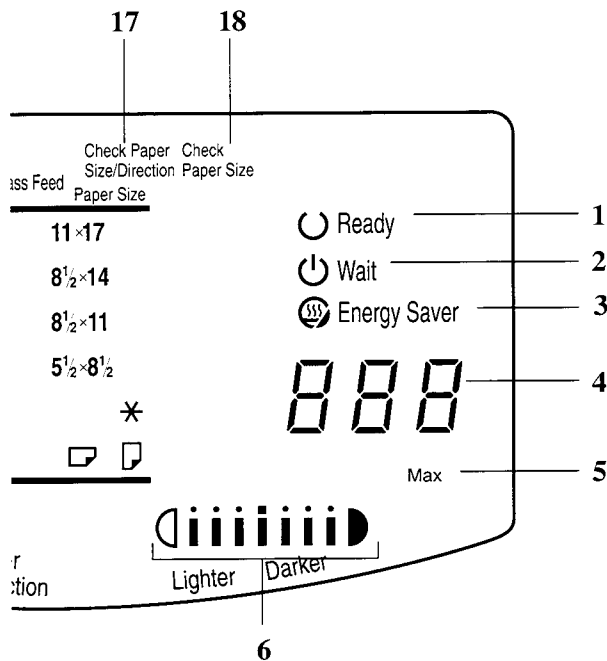
**10. Misfeed Location display**

☛ See page 101.

11. Add Staple indicator

☛ See pages 90 and 99.

12. Load Paper indicator

☛ See pages 90 and 95.

13. Add Toner indicator

☛ See pages 90 and 98.

14. Check Paper Path indicator

☛ See pages 90 and 101.

15. Paper Size indicators

Show the selected feed station, copy paper size, and direction.

16. Bypass Feed indicator

☛ See page 46.

17. Check Paper Size/Direction indicator

☛ See page 93.

18. Check Paper Size indicator

☛ See page 92.

Keys 2 With 1000-sheet Large Capacity Tray And Unit For Two-sided Copying

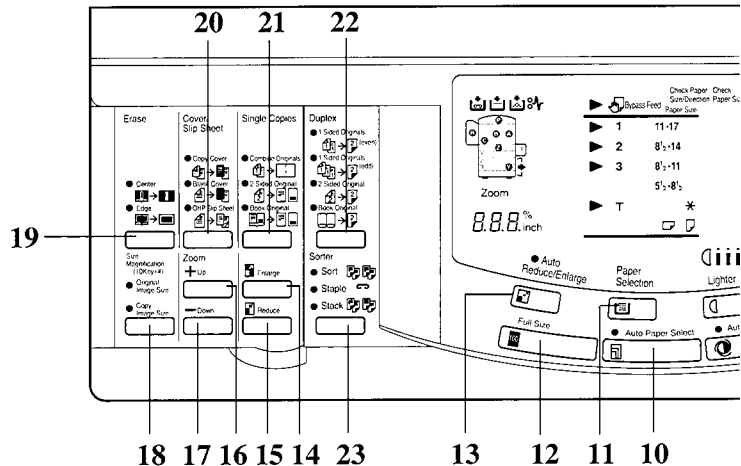

1. **Program key** See page 70.
2. **Clear Modes/Energy Saver key**
Press to clear the copier of previously entered settings. Press this key for more than 1 second to enter/exit the Energy Saver mode. See pages 39 and 85.
3. **Interrupt key** See pages 47 and 48.
4. **Recall/Enter key**
Use to enter data in selected mode.
5. **Start key**
Press to start copying.
Use to set the Auto Start.
 See page 53.
6. **Clear/Stop key**
Press to cancel the copy number entered. While copying, press to stop copying. This key is also used to clear data.
7. **Number keys**
Use to enter the desired number of copies. They are also used to enter data.
8. **Lighter and Darker keys**
 See page 41.
9. **Auto Image Density key**
 See page 41.
10. **Auto Paper Select key**
 See page 42.

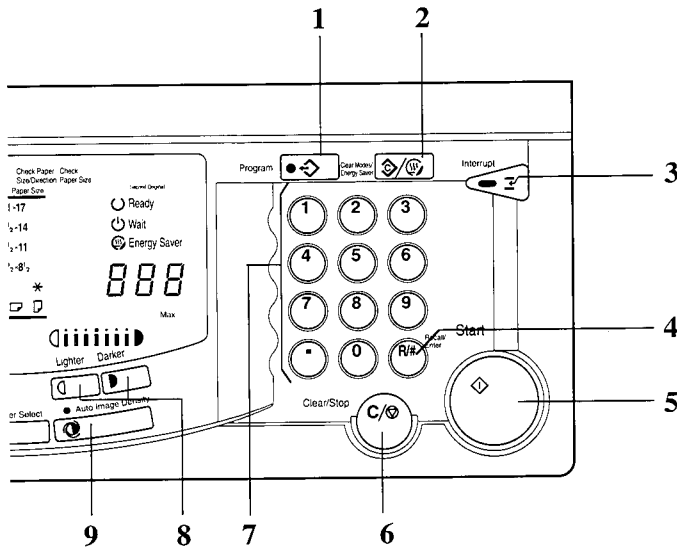

- 11. Paper Selection key**
 See page 40.
- 12. Full Size key** See page 40.
- 13. Auto Reduce/Enlarge key**
 See page 44.
- 14. Enlarge key** See page 49.
- 15. Reduce key** See page 49.
- 16. Zoom Up key**
 Enlarges in 1% steps. See page 50.
- 17. Zoom Down key**
 Reduces in 1% steps. See page 50.
- 18. Size Magnification key**
 Copier sets the magnification for your paper and original sizes. See page 51.
- 19. Erase key** See page 66.
 or
10 Key Zoom key See page 50.
- 20. Cover/Slip Sheet key**
 See pages 59 ~ 65.
- 21. Single Copies key** See pages 54 ~ 58.
- 22. Duplex key**
 See pages 73 ~ 76.
- 23. Sorter key (option)**
 See pages 77 ~ 83.
- or**
Margin Adjustment key
 See page 68.

Indicators 2 With 1000-sheet Large Capacity Tray And Unit For Two-sided Copying

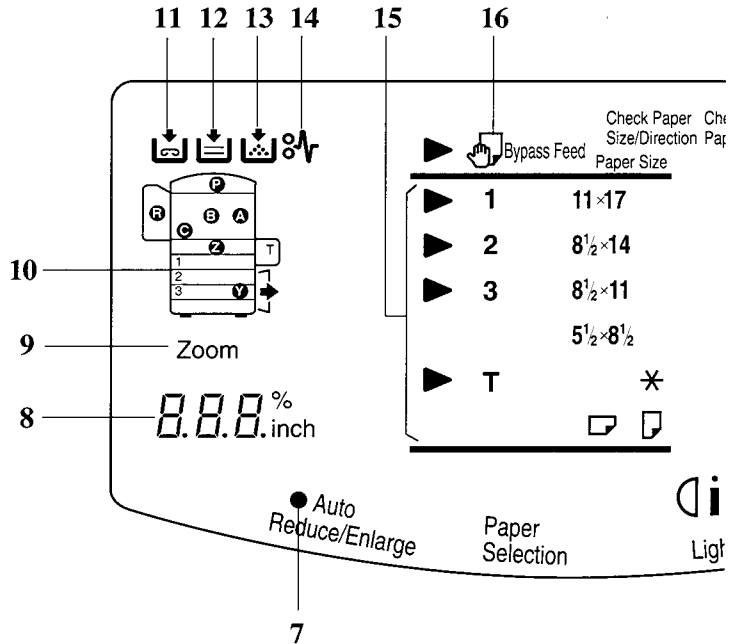

1. **Ready indicator** ☛ See page 38.
2. **Wait indicator** ☛ See page 38.
3. **Energy Saver indicator**
☛ See pages 39 and 85.
4. **Copy Counter**
Indicates the number of copies.
Data display. ☛ See pages 91 and 118.
5. **Max indicator** ☛ See page 93.
6. **Manual Image Density indicator**
☛ See pages 41 and 93.
7. **Auto Reduce/Enlarge indicator**
☛ See page 44.
8. **Three Digit indicator**
Data display.
9. **Zoom indicator**
Lights when you use the Zoom function.

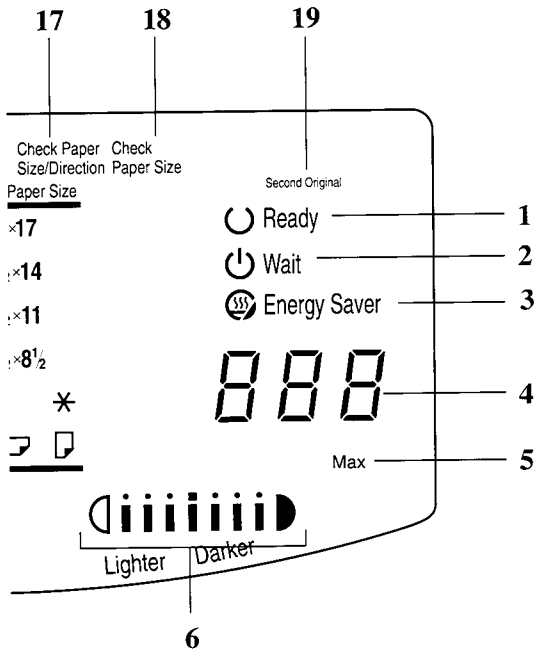

- 10. Misfeed Location display**
☛ See page 101.
- 11. Add Staple indicator** ☛ See pages 90 and 99.
- 12. Load Paper indicator**
☛ See pages 90 and 95.
- 13. Add Toner indicator** ☛ See pages 90 and 98.
- 14. Check Paper Path indicator**
☛ See pages 90 and 101.
- 15. Paper Size indicators**
Show the selected feed station, copy paper size, and direction.
- 16. Bypass Feed indicator**
☛ See page 46.
- 17. Check Paper Size/Direction indicator** ☛ See page 93.
- 18. Check Paper Size indicator**
☛ See page 92.
- 19. Second Original indicator**
☛ See pages 93.

WHAT YOU CAN DO WITH THIS COPIER

WHAT YOU CAN DO WITH
THIS COPIER

FUNCTIONS

Auto image density

➡ See page 41.

Manual image density

➡ See page 41.

Having the copier choose the paper size

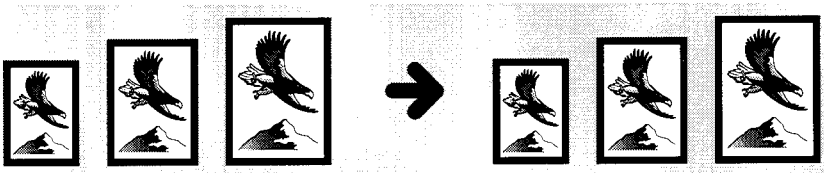

➡ See page 42.

Having the copier choose the reproduction ratios

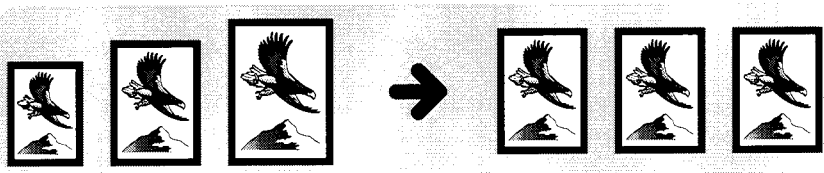

➡ See page 44.

Copying from the bypass feed table

➡ See page 45.

Temporarily stopping one job to copy something else

➡ See page 47.

Reducing and enlarging

Reducing and enlarging using preset ratios



Reducing and enlarging with the Zoom Up (+) and Zoom Down (-) keys
Reducing and enlarging with Number keys



Fitting the original to a copy of a different size



☛ See page 49.

Entering copy job settings during the warm-up period

☛ See page 53.

WHAT YOU CAN DO WITH THIS COPIER

Making one-sided copies from various originals

From 2 one-sided originals to 1 one-sided copy

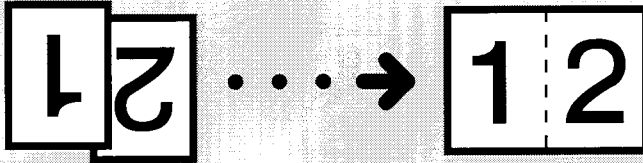

From 1 two-sided original to 2 one-sided copies

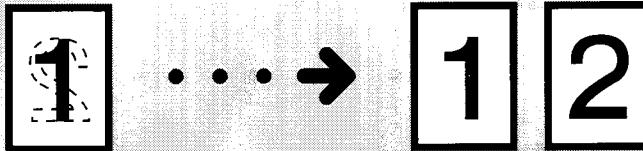

From 2 facing pages to 2 one-sided copies

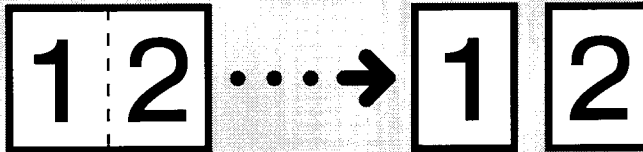

➤ See page 54.

Adding or inserting sheets

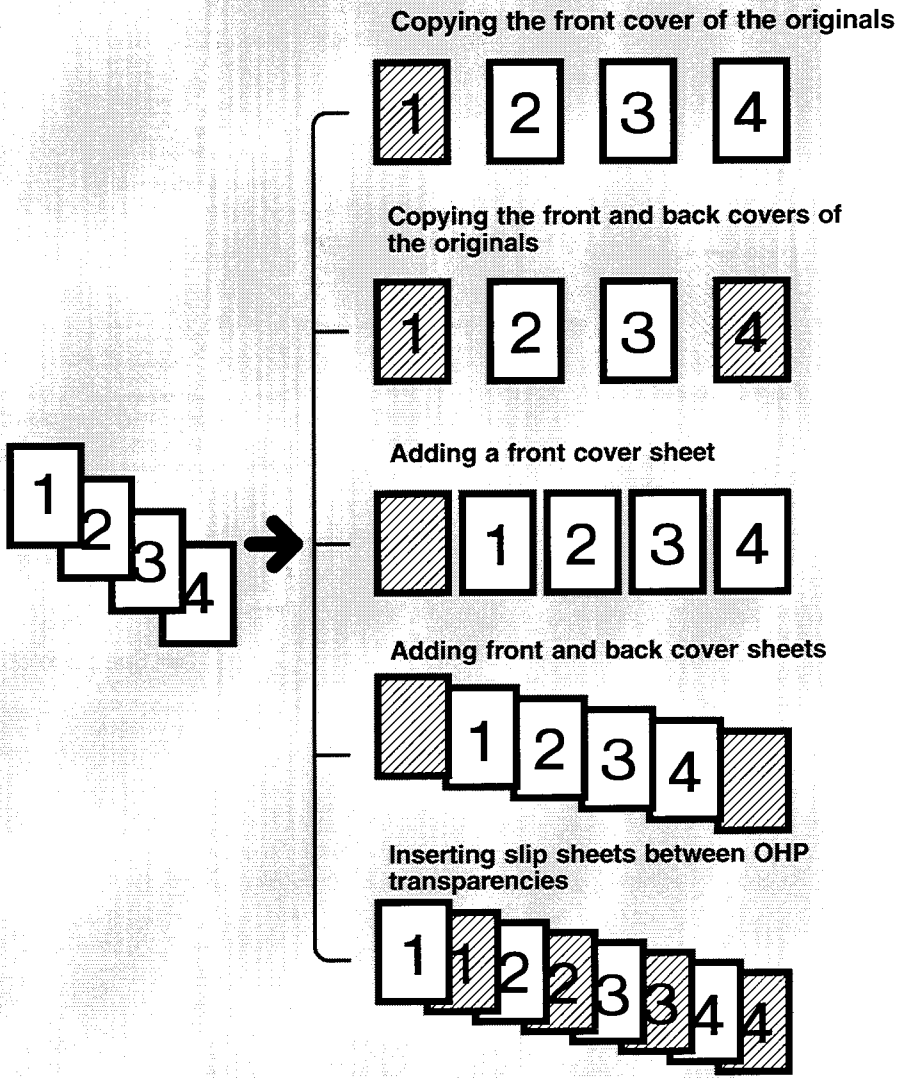

WHAT YOU CAN DO WITH THIS COPIER

See page 59.

Erasing parts of copy image

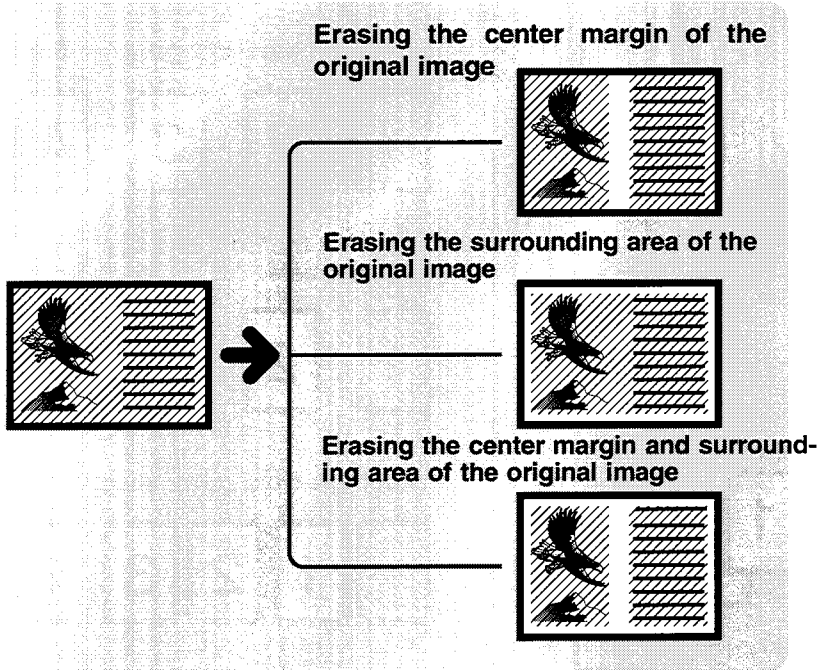

➡ See page 66.

Adding margins for binding

Margin for one-sided copying



Margin for two-sided copying

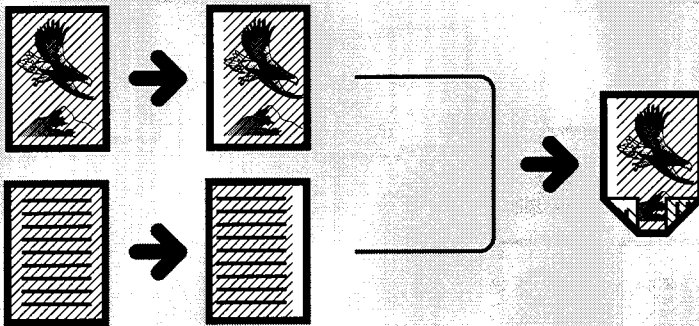

➤ See page 68.

Storing your copy settings in memory

➤ See page 70.

WHAT YOU CAN DO WITH THIS COPIER

Making two-sided copies

From an even number of one-sided originals

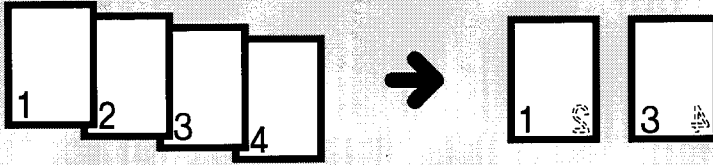

From an odd number of one-sided originals

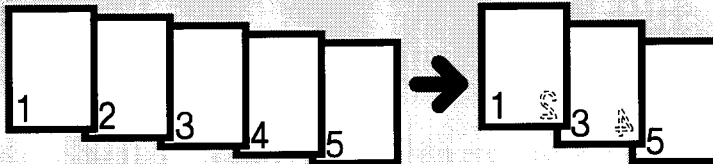

From two-sided originals



From facing pages

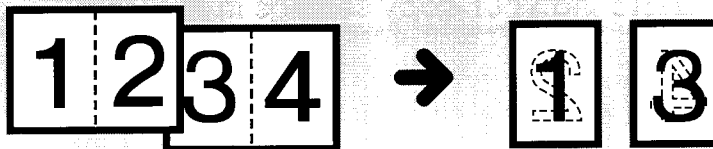

See page 73.

Finishing

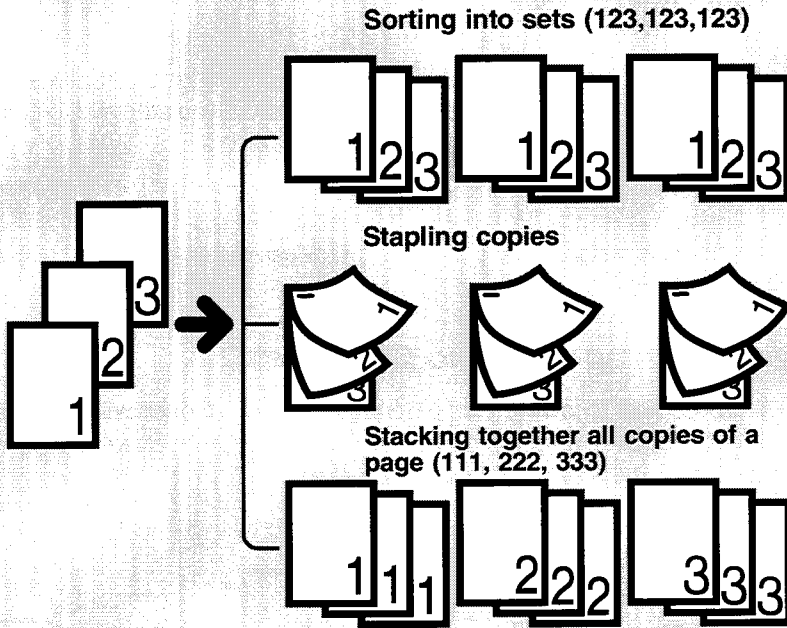

WHAT YOU CAN DO WITH THIS COPIER

See page 77.

Example 1

You have to give a presentation of your company's new products to your clients tomorrow. Now, you have finished making the material but you still have to copy this material to OHP sheets and also make copies for your clients.

- For copying your material onto OHP sheets, you'll use the optimal document feeder.
- For copying your material for your clients, you'll use the 20-bin (or 10-bin) sorter stapler options.

Copying your material onto OHP sheets

If you make copies following the procedure below, sheets will be inserted between OHP sheets to prevent friction between OHP sheets. This way, you can smoothly take and set your OHP sheets.

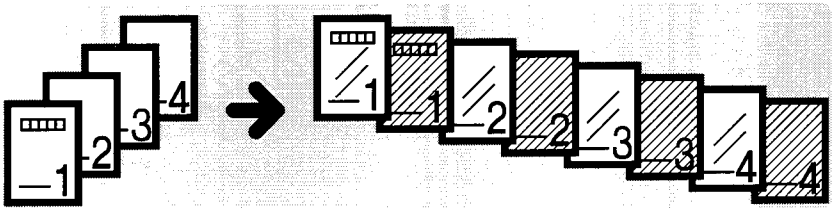

➤ **Inserting slip sheets between OHP transparencies**

➤ See page 64.

Copying and stapling your material for your clients

Make the required number of stapled copies.



➤ **Stapling copies** ➤ See page 78.

Example 2

You are studying for an examination, but because you were absent from your classes for two days and you could not take notes, you have to ask your friend to lend you his notebook to make copies of it.

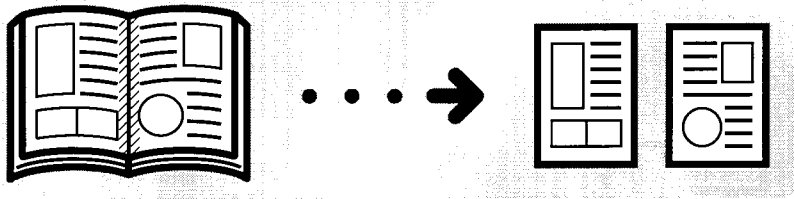

↪ **Making 2 one-sided copies from 2 facing pages**
☛ See page 57.

↪ **Erasing the surrounding area of the original image**
☛ See page 66.

WHAT YOU CAN DO WITH
THIS COPIER

Example 3

Every Monday, you distribute a report named "Weekly events at the head office" to local branches. Your report is always 27 pages. You want to make required number of 2-sided copies.

- ☐ Your copier has a large capacity tray and a unit for two-sided copying and a 20-bin sorter.

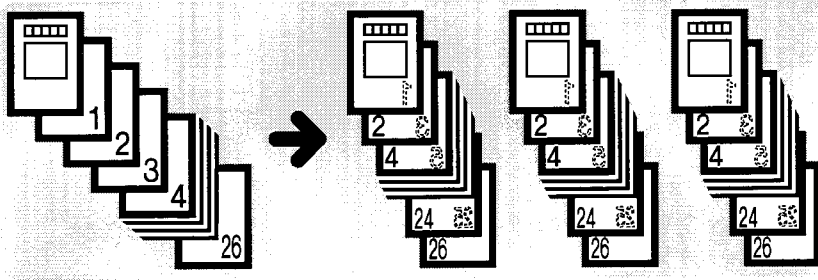

↳ **Making two sided copies from an odd number of one sided originals** ➤ See page 73.

↳ **Sorting into sets (123, 123, 123)** ➤ See page 77.

Because you make the same copies every Monday, we suggest that you store these settings in the copier's memory.

↳ **Storing your copy settings in memory** ➤ See page 70.

SETTING ORIGINALS

SETTING ORIGINALS

Recommended Originals

- Regarding originals that the optional document feeder can handle, see page 157.

Non-recommended Originals For The Optional Document Feeder

Caution: The following types of originals are not recommended for use with the document feeder. Place them directly on the exposure glass.

- Originals thicker than 34 lb
- Originals thicker than 28 lb when using two-sided originals
- Originals thinner than 11 lb. But for originals between 11 and 14 lb, the document feeder must be set to Thin Original mode. See page 131.
- Originals larger than 11" x 17"
- Originals smaller than 5 1/2" x 8 1/2"
- Originals smaller than 5 1/2" x 8 1/2" sideways when you use Combine Originals See page 54.
- Paper with any kind of coating (such as carbon) on the back
- Folded, curled, creased, or damaged originals
- Mailing labels, or perforated originals
- Bound, stapled, or clipped originals
- OHP transparencies
- Translucent paper
- Pasted originals
- Damp originals
- Sticky originals
- Wavy originals
- Originals that are not made from paper
- Originals written in pencil on both sides, or two-sided carbon originals
- Thermal fax paper

SETTING ORIGINALS ON THE EXPOSURE GLASS

- 1** Lift the platen cover or the optional document feeder.

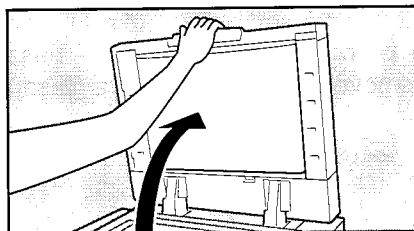

- 2** Set the original *face down* on the exposure glass. The original should be aligned to the rear left corner.

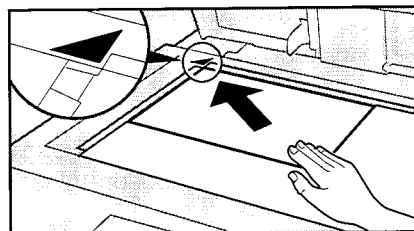

- 3** Lower the platen cover or the optional document feeder.

SETTING A STACK OF ORIGINALS IN THE OPTIONAL DOCUMENT FEEDER

You can insert a stack of originals (one-sided or two-sided) of the same size into the document feeder. These originals are individually fed onto and removed from the exposure glass.

- If you want to set originals of different sizes at the same time, use the user tools.
➤ See page 130.

1 Correct any curl, fold, or crease in the originals before setting.

2 Confirm that the **Insert Original** indicator is lit before setting the originals.

3 Confirm that no previous originals remain on the exposure glass.

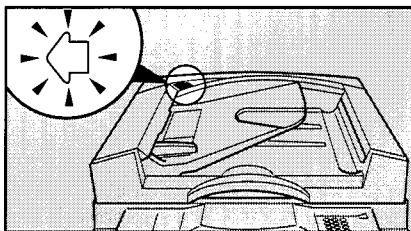

4 Adjust the guide to the original size.

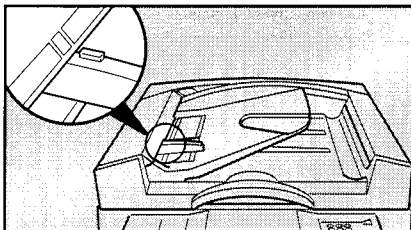

5 Set the originals *face up* into the document feeder until the **Insert Original** indicator goes off.

- The last page should be on the bottom.
- The guide must touch the front side of the originals.

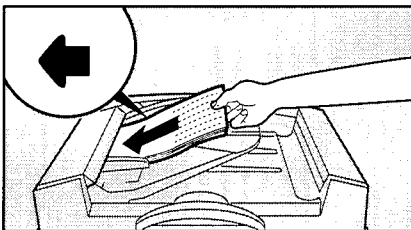

SETTING A STACK OF ORIGINALS IN THE OPTIONAL DOCUMENT FEEDER

- Do not stack originals above the limit mark.

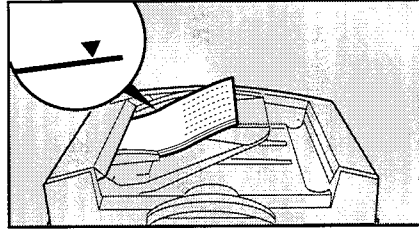

SETTING ONE ORIGINAL AT A TIME IN THE OPTIONAL DOCUMENT FEEDER

You can insert one original at a time into the document feeder. The original is automatically fed onto and removed from the exposure glass.

1 Correct any curl, fold, or crease in the originals before setting.

2 Confirm that the **Insert Original** indicator is lit before setting the originals.

3 Confirm that no previous originals remain on the exposure glass.

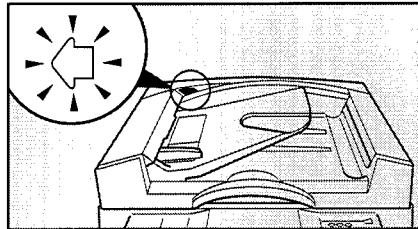

4 Adjust the guide to the original size.

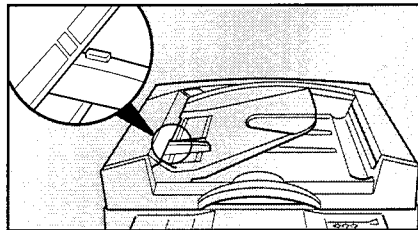

5 Set the original *face up* into the document feeder until the **Insert Original** indicator goes off.

- If you are copying a stack of originals one sheet at a time and you want to keep them in order, start with the last page of the originals.
- The original guide must touch the front side of the original.

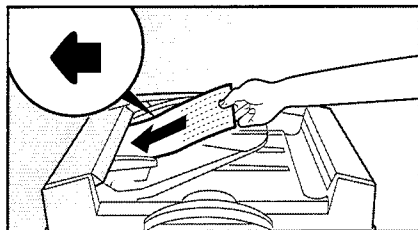

6 Press the **Start** key.

7 While the **Auto Feed** indicator is lit after an original is fed, set the next original. The original is automatically fed and copied.

- If you have set more than two originals, the **Auto Feed** indicator is not lit after the last original is fed. In this case, press the **Start** key again after setting an original.

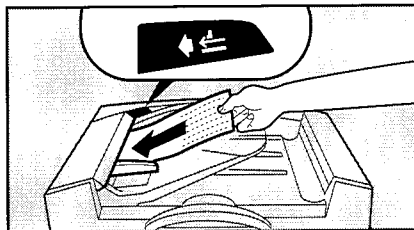

COPYING





STARTING THE COPIER

When The Main Switch Is In The Stand-by Position

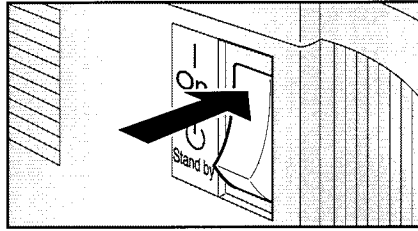
- 1** Turn on the main switch.



- 2** Wait for the copier to warm-up. During the warm-up period (less than 80 seconds), the  **Wait** indicator is on.
- 3** After the warm-up, the  **Ready** indicator lights.

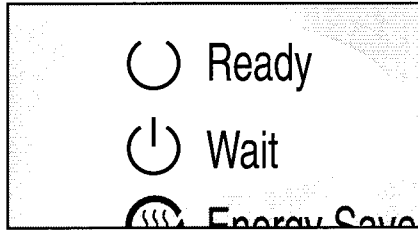



When The Energy Saver Indicator Is On

The copier is in the Energy Saver or Auto Off mode.

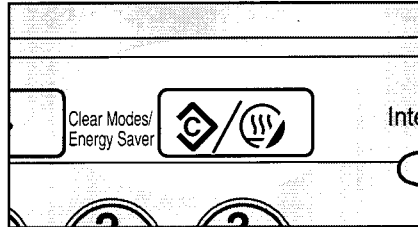

Press the **Clear Modes/Energy Saver** key to return to the ready condition.



- For details about Energy Saver,  see pages 85 and 124.
- For details about Auto Off,  see page 125.
- The following actions will also make the copier ready:
 - Opening or closing the platen cover.
 - Opening or closing the optional document feeder.
 - Setting originals in the optional document feeder.
 - Opening or closing the bypass feed table.
 - Setting copy paper in the bypass feed table.
 - Pressing any key except the **Start** key.

When The Copier Is Set For User Codes

Input your user code (3 digits) using the **Number** keys. Press the **Recall/Enter** key.

- To prevent others from making copies using your user code, press the **Clear/Stop** and **Clear Modes/Energy Saver** key simultaneously after copying.
- Regarding user codes,  see page 132.
- To set your copier for user codes, contact your service representative.  See page 140.

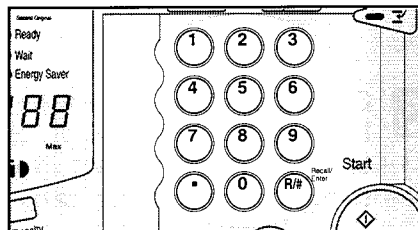

FREQUENTLY USED FUNCTIONS

One-to-one Copying

You can make copies that are the same size as your originals.

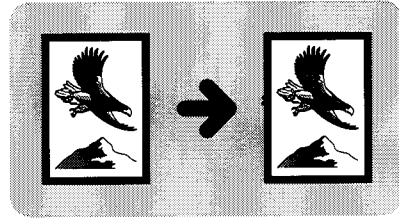

1 Set your original on the exposure glass or in the optional document feeder. See page 31, 32, or 34.

2 Enter the number of copies required using the **Number** keys.

To change the number entered, press the **Clear/Stop** key, then enter the new number.

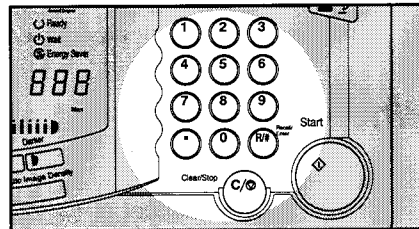

3 Confirm that the **Auto Paper Select** indicator is on. If not, press the **Auto Paper Select** key, or select the copy paper using the **Paper Selection** key.

Regarding Auto Paper Select, see page 42.

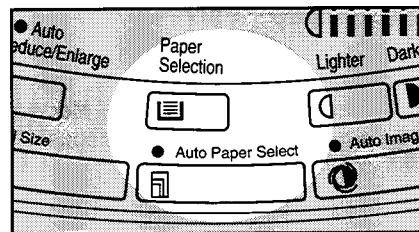

4 Make sure that the magnification ratio is set to 100%. If not, press the **Full Size** key.

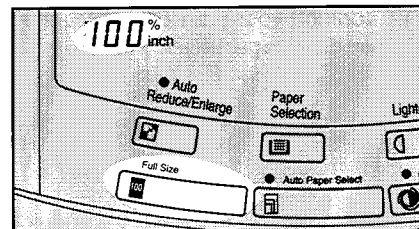

5 Press the **Start** key.

- To stop the copier during the multi-copy run, press the **Clear/Stop** key.
- Press the **Start** key to resume copying, or press the **Clear/Stop** key again to clear the entered copy number.

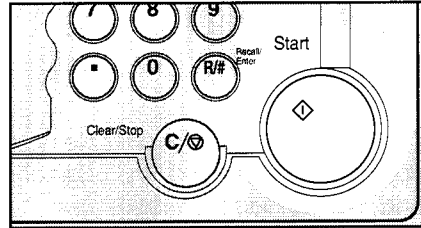

Adjusting Copy Image Density

To match the type of originals, adjust the image density.

Auto image density

If the **Auto Image Density** indicator is lit, the copier automatically controls the image density. If the indicator is not lit, press the **Auto Image Density** key.

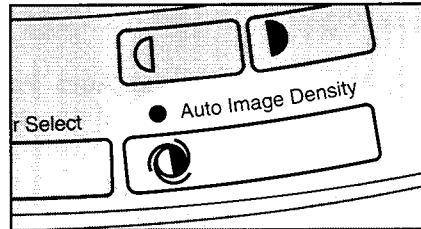

Manual image density

If you have dark or light originals, adjust the image density yourself.

Press the **Lighter** (left) key to lower the image density. Press the **Darker** (right) key to increase the image density.

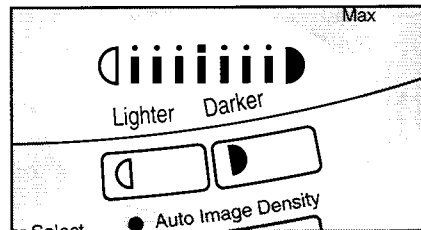

COPYING

Having The Copier Choose The Paper Size (Auto Paper Select)

The copier selects a suitable size of copy paper based on the original size and the reproduction ratio.

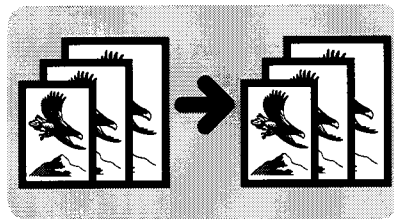

- If you use translucent or transparent originals or originals with tags, the original size might not be detected correctly.
- When placing the original on the exposure glass directly, make sure that the platen cover or optional document feeder is lowered before pressing the **Start** key. If not, the original size might not be detected correctly.
- Regarding functions that cannot be used together with this function, see page 86.

Example 1: When making full size copies

- 1** Make sure that the **Auto Paper Select** indicator is lit. If not, press the **Auto Paper Select** key.

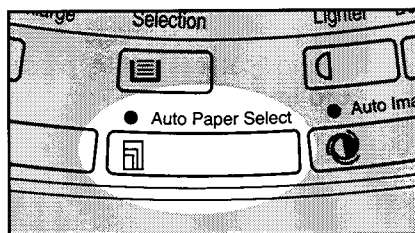

- 2** Make sure that the magnification ratio is set to 100%. If not, press the **Full Size** key.

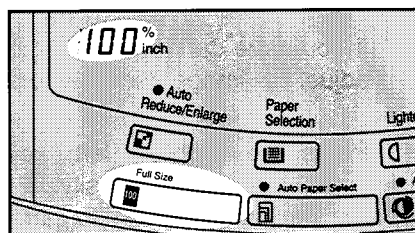

- 3** Set your original on the exposure glass or in the optional document feeder. See page 31, 32 or 34.

- 4** Press the **Start** key.
The copier selects paper of the same format and orientation as the original.

Example 2: When making reduced copies

Example: Original: 11" x 17" lengthwise
 Reproduction ratio: 65%

- 1 Make sure that the **Auto Paper Select** indicator is lit. If not, press the **Auto Paper Select** key.

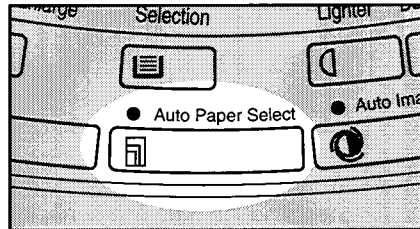

- 2 Select 65% using the **Reduce** key.

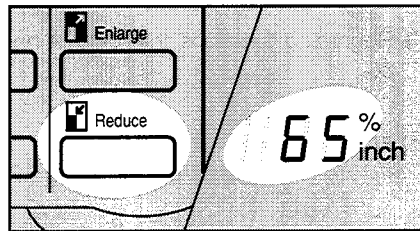

- 3 Set your original on the exposure glass or in the optional document feeder. See page 31, 32, or 34.

- 4 Press the **Start** key.

8 1/2" x 11" lengthwise copy paper will be selected.

Having The Copier Choose The Reproduction Ratios (Auto Reduce/Enlarge)

The copier can select the proper reproduction ratio based on the selected paper size and the original size.

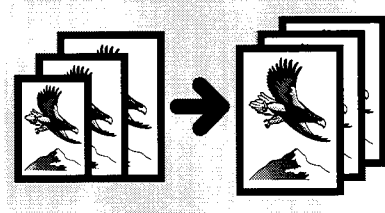

- If you use translucent or transparent originals or originals with tags, the original size might not be detected correctly.
- When placing the original on the exposure glass directly, make sure that the platen cover or optional document feeder is lowered before pressing the **Start** key. If not, the original size might not be detected correctly.
- Regarding functions that cannot be used together with this function, see page 86.

Example: Original size: 11" x 17" lengthwise
 Copy paper size: 8 1/2" x 11" lengthwise

1 Press the **Auto/Reduce Enlarge** key.

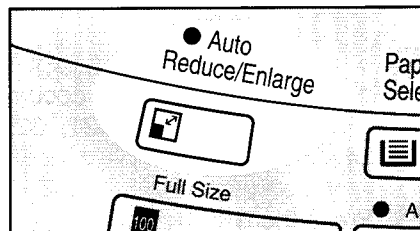

2 Set your original on the exposure glass or in the optional document feeder. See page 31, 32, or 34.

3 Select the copy paper using the **Paper Selection** key.

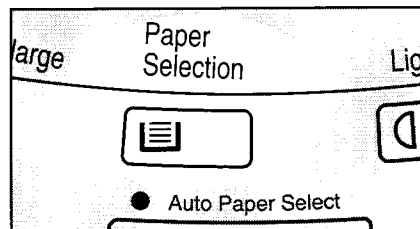

4 Press the **Start** key. 65% will be selected.

Copying From The Bypass Feed Table

Use the bypass feed table to copy onto OHP transparencies, adhesive labels, translucent paper, and post cards.

- Adhesive labels should be fed from the bypass feed table one sheet at a time.
- OHP transparencies should be fed from the bypass feed table. You can set ten sheets at a time. However, if misfeed or multi-feed occurs, set sheets one at a time.
- OHP transparencies should be fanned to get air between the sheets before loading.
- Translucent paper should be fed from the bypass feed table.
- Translucent paper should be fed so that the paper grain is oriented with the paper path.
- Postcards should be fed from the bypass feed table. Correct any curls they might have before loading them.
- It is recommended to feed one post card at a time.
- When you use the bypass feed table while placing the original directly on the exposure glass, lower the platen cover or optional document feeder before pressing the **Start** key.
- Regarding functions that cannot be used together with this function, see page 86.

1 Set your original on the exposure glass or in the optional document feeder. See page 31, 32, or 34.

2 Open the bypass feed table.

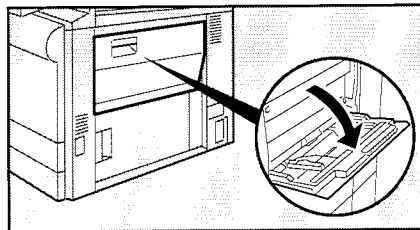

FREQUENTLY USED FUNCTIONS

- 3** Make sure that the  **Bypass Feed** indicator is lit. If it is not lit, press the **Paper Selection** key to select the bypass feed table.

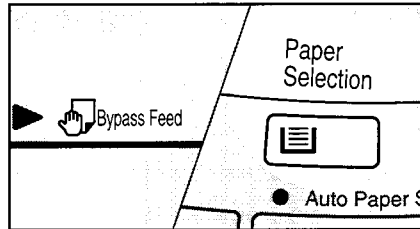

- 4** Slide the paper guides to the paper width and, if necessary, swing out the extender to support large size copy paper.

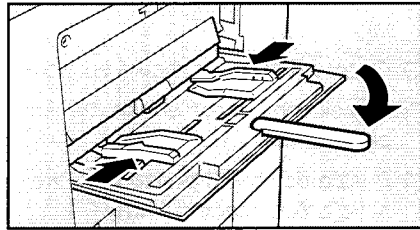

- 5** Insert the copy paper into the bypass feed table.

- Approximately 40 sheets of copy paper (20 lb) can be inserted at a time.
- Do not insert copy paper after the **Load Paper** () indicator turns off.

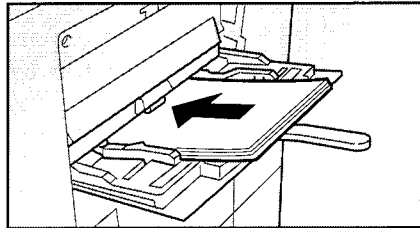

- 6** Press the **Start** key.

Temporarily Stopping One Job To Copy Something Else (Interrupt Copying)

Use the **Interrupt** key to interrupt a multicopy run to make urgently needed copies.

- Regarding functions that cannot be used together with this function, see page 86.

Without the optional document feeder

- 1** Press the **Interrupt** key. The copier will stop the copy run and store the present settings in the memory. The copier will return to the ready condition.

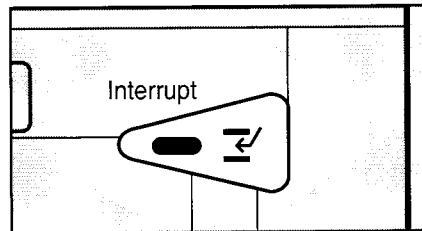

- 2** Remove the previous original. Set your original for interrupt copying on the exposure glass. See page 31.

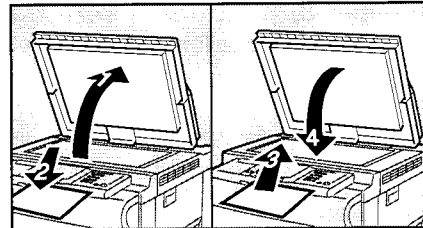

- 3** Make your copies.

- 4** After interrupt copying is completed, press the **Interrupt** key again. The copier will recall the previous copy settings.

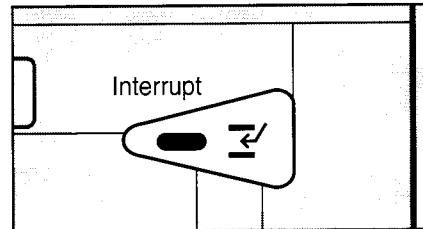

- 5** Reset the previous original and press the **Start** key to resume the previous run.

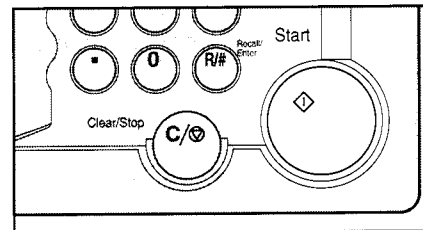

With the optional document feeder

1 Press the **Interrupt** key. The copier will stop the copy run and store the present settings in the memory. The original on the exposure glass will exit from the document feeder. The copier will return to the ready condition.

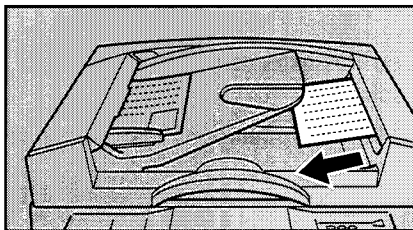

2 Take the originals from the exit stack.

3 Separately take the remaining originals off the original table.

4 Make your copies.

5 After interrupt copying is completed, press the **Interrupt** key. The copier will recall the previous copy settings.

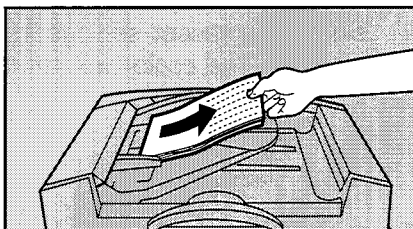

6 Some originals in the exit stack (step 2) weren't completely copied. Read the number in the **Three Digit** indicator and take that number of pages from the top of the exit stack.

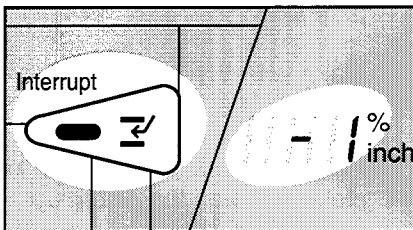

7 Place the sheets you just took on the bottom of the stack you took from the original table (step 3).

8 Place the stack you just made in the original table.

9 Press the **Start** key.



Reducing And Enlarging

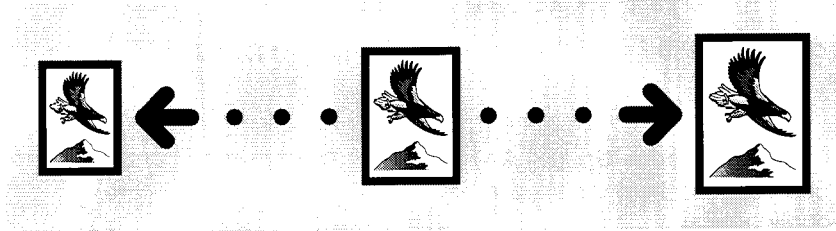

- Regarding functions that cannot be used together with this function, see page 86.

Reducing and enlarging using preset ratios

Reducing

Press the **Reduce** key to select the preset reducing ratios. The reducing ratio will change as follows:

93% → 85% → 77% → 74% → 65% → 50%

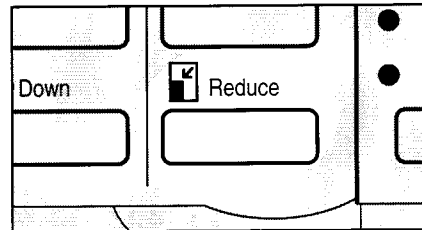

Enlarging

Press the **Enlarge** key to select the preset enlarging ratios. The enlarging ratio will change as follows:

121% → 129% → 155% → 200%

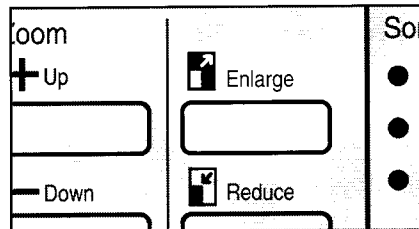

COPYING

Reducing and enlarging with the Zoom Up (+) and Zoom Down (-) keys (+ - Zoom)

You can change the reproduction ratio from 50% to 200% in 1% steps.

Press the **Zoom Up (+)** key repeatedly, or hold down the key continuously, to increase the ratio in 1% steps.

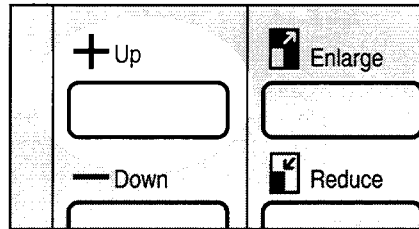

Press the **Zoom Down (-)** key repeatedly, or hold down the key continuously, to reduce the ratio in 1% steps.

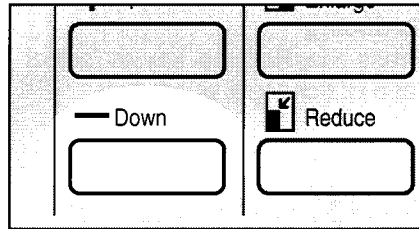

Reducing and enlarging with the number keys (10 key Zoom)

Note: Before using the 10 Key Zoom, you have to change copier's default settings with the user tools. (See page 127.) If you select the 10 Key Zoom, the Size Magnification key is used as 10 Key Zoom key. In this case, you cannot use Size Magnification.

Note: After selecting the 10 Key Zoom, put the sticker (key name sheet) for the 10 Key Zoom on the operation panel. The sticker is enclosed as an accessory.

You can enter any reproduction ratio between 50% and 200% using the **Number** keys.

- 1 Press the **10 Key Zoom (Size Magnification)** key.

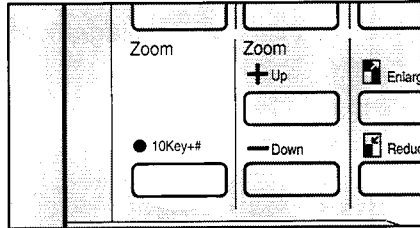

- 2 Enter the desired reproduction ratio using the **Number** keys.
 - To change the number entered, press the **Clear/Stop** key and enter the new number.

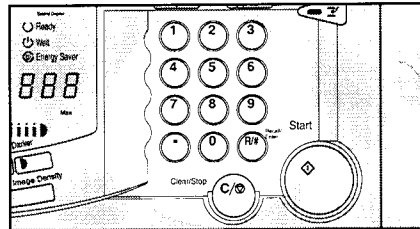

- 3 Press the **Recall/Enter** key.

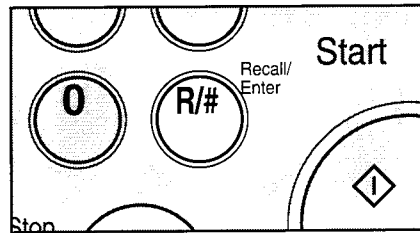

Fitting the original to a copy of a different size (Size Magnification)

Note: If you select the 10 Key Zoom using the user tool, you cannot use Size Magnification. See page 50.

The suitable reproduction ratio will be automatically selected when you enter the lengths of the original and copy image you want.



COPYING

FREQUENTLY USED FUNCTIONS

- 1** Press the **Size Magnification** key.

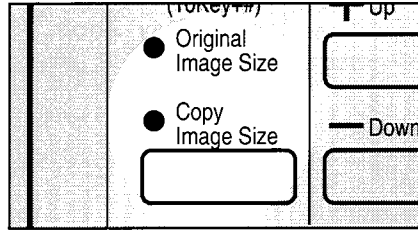

- 2** Enter the original size using the **Number** keys.

- Up to 999" can be entered.
- To change the number entered, press the **Clear/Stop** key and enter the new number.

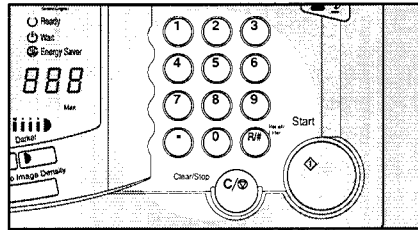

- 3** Press the **Recall/Enter** key.

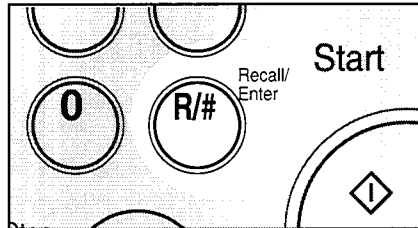

- 4** Enter the copy size using the **Number** keys.

- 5** Press the **Recall/Enter** key.

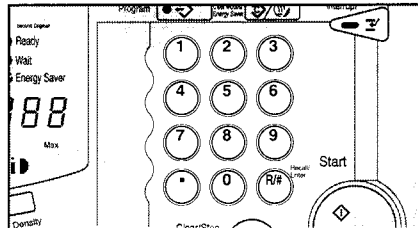

Entering Copy Job Settings During The Warm-up Period (Auto Start)

If you press the **Start** key during the warm-up period, the  **Ready** indicator will blink, then the copier will start copying after the warm-up period. Set your copy settings during warm-up period, then press the **Start** key.

- To cancel Auto Start, press the **Clear/Stop** key.

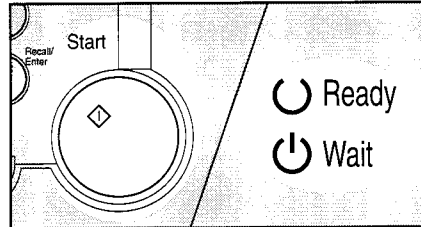

MAKING ONE-SIDED COPIES FROM VARIOUS ORIGINALS (Single Copies)

From 2 One-sided Originals To 1 One-sided Copy (Combine Originals)

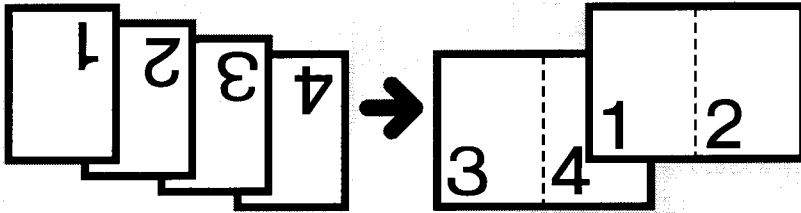

Note: This function can be used only when your copier is equipped with the optional document feeder.

- The number of originals should be a multiple of two. If not, add a blank sheet to your originals.
- Original sizes (sideways only) that can be used are as follows:
8 1/2" x 11", 5 1/2" x 8 1/2"
- Please refer to the following table when you select the copy paper size and reproduction ratio.

Original	Copy paper	Ratio
8 1/2" x 11" sideways	8 1/2" x 11" lengthwise	65%
	11" x 17" lengthwise	100%
5 1/2" x 8 1/2" sideways	8 1/2" x 11" lengthwise	100%
	11" x 17" lengthwise	129%

- Regarding functions that cannot be used together with this function, see page 86.

- 1 Press the **Single Copies** key to light the **Combine Originals** indicator.

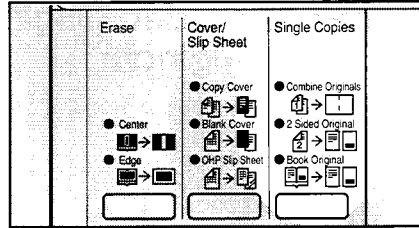

- 2 Set your originals in the optional document feeder. (See page 32.) When setting originals, the top and bottom originals should be placed upside down as shown in the illustration to make copies that read from left to right.

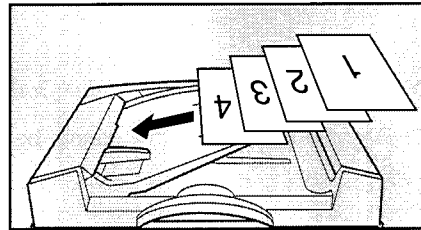

- ☐ If you want to make copies that read from right to left, set your originals as usual.

- 3 Select the copy paper size using the **Paper Selection** key.

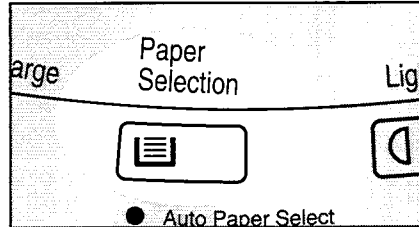

- 4 Select the reproduction ratio using the **Reduce** or **Enlarge** key.

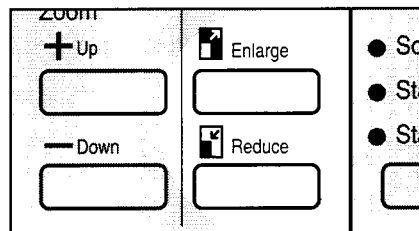

- 5 Press the **Start** key.

COPYING

From 1 Two-sided Original To 2 One-sided Copies (2 Sided Original)

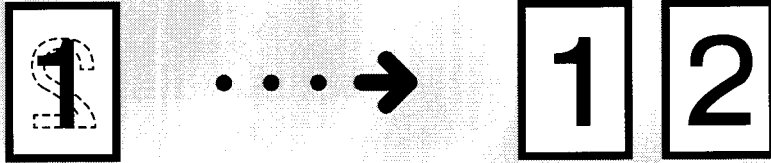

Note : We recommend using this function with the optional document feeder.

Regarding functions that cannot be used together with this function, see page 86.

1 Press the **Single Copies** key to light the **2 Sided Original** indicator.

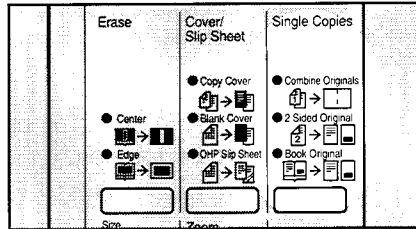

2 Set your originals in the optional document feeder. See page 32.

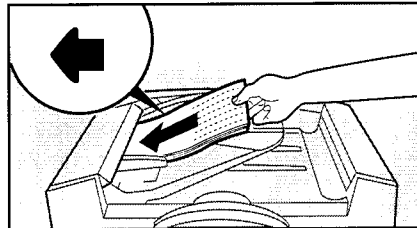

3 Press the **Start** key.

From 2 Facing Pages To 2 One-sided Copies (Book Original)

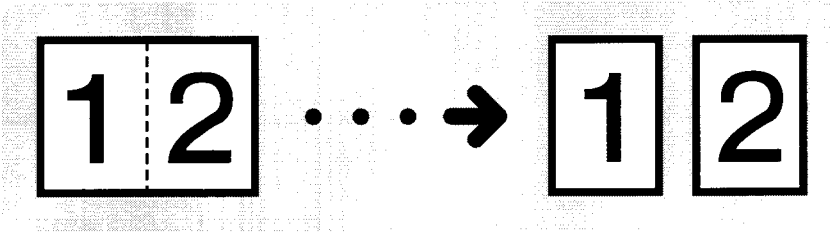

- Copy paper sizes (sideways only) that can be used are as follows:
8 1/2" x 11", 5 1/2" x 8 1/2"
- Regarding functions that cannot be used together with this function, see page 86.

1 Press the **Single Copies** key to light the **Book Original** indicator.

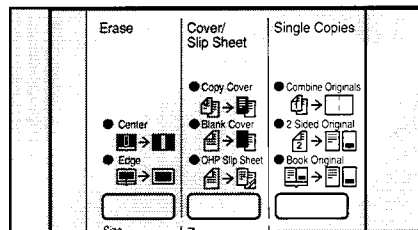

2 Start with the last page of your book original and work your way to the beginning. Place the original *face down* on the exposure glass and align the last page with the left scale.

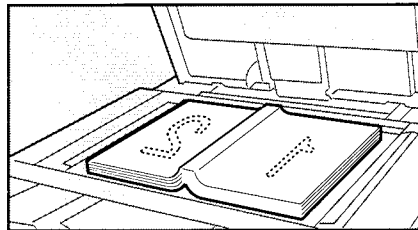

MAKING ONE-SIDED COPIES FROM VARIOUS ORIGINALS (Single Copies)

Or, set the facing original in the optional document feeder. See page 32 or 34.

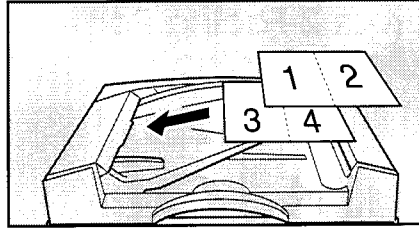

3 Select the copy paper size using the **Paper Selection** key.

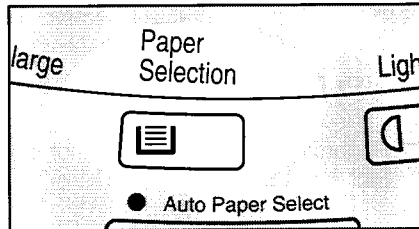

4 Press the **Start** key.

ADDING OR INSERTING SHEETS (Cover/Slip Sheet)

Copying The Front Cover Of The Originals (Copy Cover)

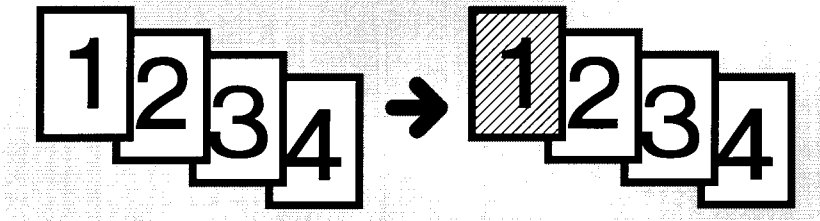

Note: This function can be used only when your copier is equipped with the optional document feeder.

Note: The copier can also copy the back cover of the originals. Set the copier with the user tools. (☛ See page 126.) If you do, ☛ see page 60.

Regarding functions that cannot be used together with this function, ☛ see page 86.

1 Press the **Cover/Slip Sheet** key to light the **Copy Cover** indicator.

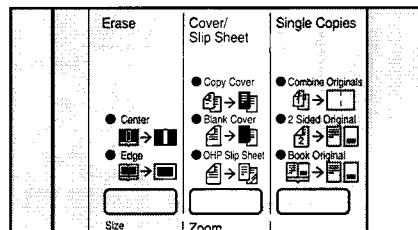

COPYING

ADDING OR INSERTING SHEETS (Cover/Slip Sheet)

- 2** Set paper for cover sheets in the bypass feed table.
Make sure to set paper that is identical in size and direction with the paper to which you are copying (step 3).

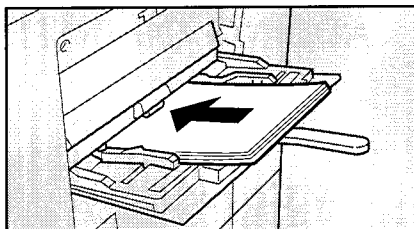

- 3** Select copy paper using the **Paper Selection** key.
- You cannot select the large capacity tray.

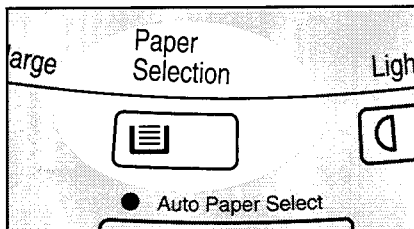



- 4** Set your originals in the optional document feeder.  See page 32.

- 5** Press the **Start** key.

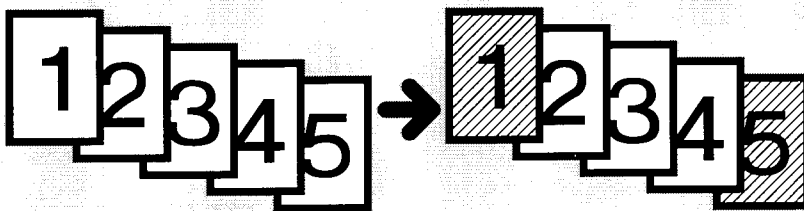
Copying The Front And Back Covers Of The Originals



Note: This function can be used only when your copier is equipped with the optional document feeder.

Note: You can select this setting with the user tools. ( See page 126.) If you do not select this setting, only the first page of the originals is copied. ( See page 59.)

- Regarding functions that cannot be used together with this function,  see page 86.

ADDING OR INSERTING SHEETS (Cover/Slip Sheet)

- 1** Press the **Cover/Slip Sheet** key to light the **Copy Cover** indicator.

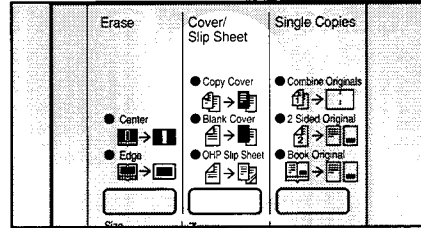

- 2** Set paper for cover sheets in the bypass feed table. Make sure to set paper that is identical in size and direction with the paper to which you are copying (step 3).

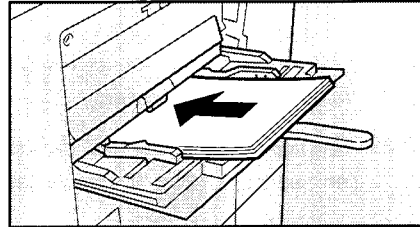

- 3** Select copy paper using the **Paper Selection** key.

- You cannot select the large capacity tray.

- 4** Set your originals in the optional document feeder. See page 32.

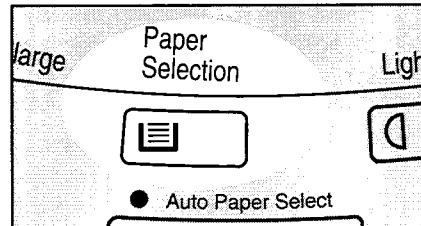

- 5** Press the **Start** key.

Adding A Front Cover Sheet (Blank Cover)

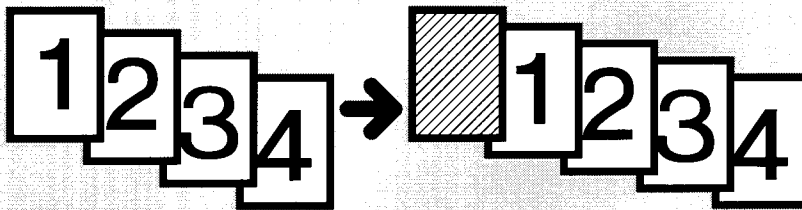

Note: This function can be used only when your copier is equipped with the optional document feeder.

Note: The copier can also add the back cover. Set the copier with the user tools. (☛ See page 126.) If you do, ☛ see page 63.

Regarding functions that cannot be used together with this function, ☛ see page 86.

1 Press the **Cover/Slip Sheet** key to light the **Blank Cover** indicator.

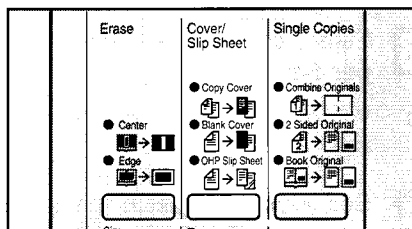

2 Set paper for cover sheets in the bypass feed table. Make sure to set paper that is identical in size and direction with the paper to which you are copying (step 3).

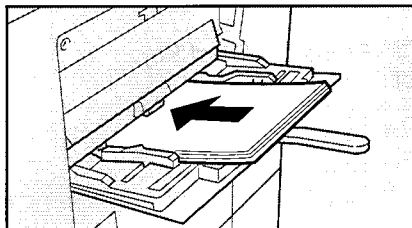

3 Select copy paper using the **Paper Selection** key.

You cannot select the large capacity tray.

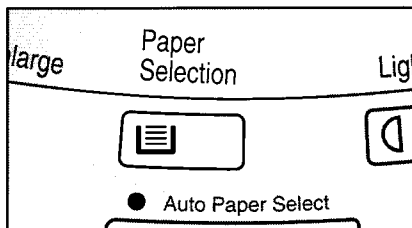

- 4 Set your originals in the optional document feeder. ➤ See page 32.
- 5 Press the **Start** key.

Adding Front And Back Cover Sheets

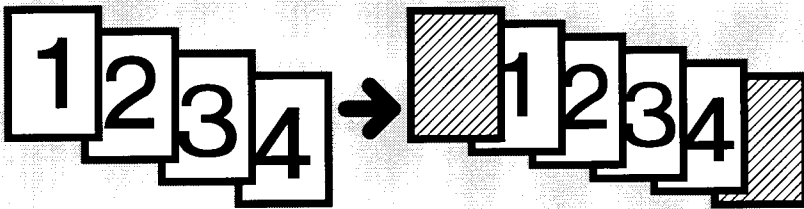

Note: This function can be used only when your copier is equipped with the optional document feeder.

Note: You can select this setting with the user tools. (➤ See page 126.) If you do not select this setting, only the front cover is added. (➤ See page 62.)

- Regarding functions that cannot be used together with this function, ➤ see page 86.

- 1 Press the **Cover/Slip Sheet** key to light the **Blank Cover** indicator.

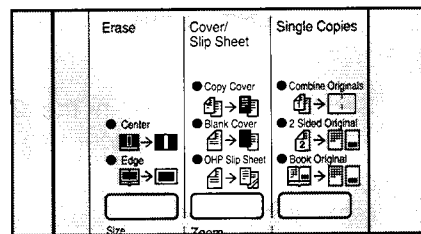

- 2 Set paper for cover sheets in the bypass feed table. Make sure to set paper that is identical in size and direction with the paper to which you are copying (step 3).

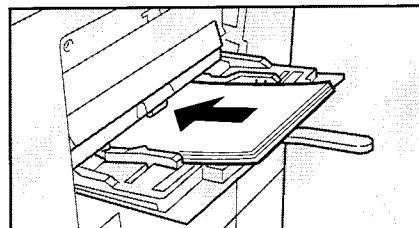

ADDING OR INSERTING SHEETS (Cover/Slip Sheet)

3 Select copy paper using the **Paper Selection** key.

- You cannot select the large capacity tray.

4 Set your originals in the optional document feeder.  See page 32.

5 Press the **Start** key.

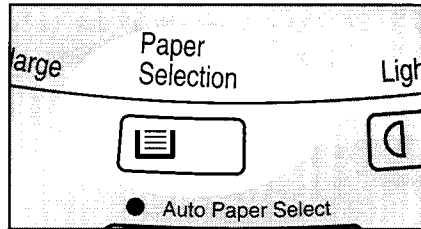

Inserting Slip Sheets Between OHP Transparencies (OHP Slip Sheet)

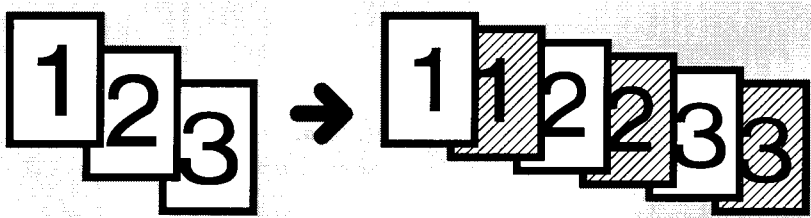

- Regarding functions that cannot be used together with this function,  see page 86.

1 Set the slip sheets in the 250-sheet or 500-sheet paper tray.

- Do not set the slip sheets in the large capacity tray.

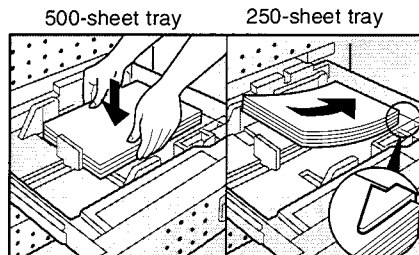

ADDING OR INSERTING SHEETS (Cover/Slip Sheet)

2 Set the OHP transparencies in the bypass feed table.

- You can set ten sheets at a time. However, if misfeed or multi-feed occurs, feed one sheet at a time.
- OHP transparencies should be fanned to get air between the sheets before loading.

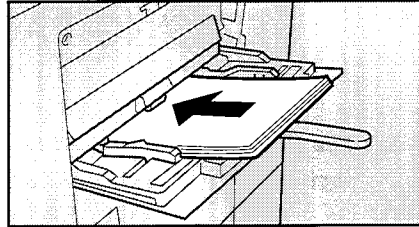

3 Press the **Cover/Slip Sheet** key to light the **OHP Slip Sheet** indicator.

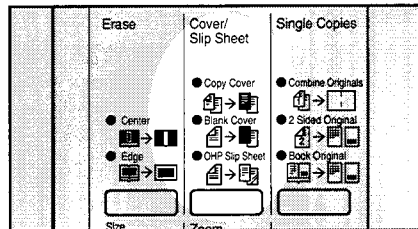

4 Using the **Paper Selection** key, select the paper tray where you have set the slip sheets (step 1).

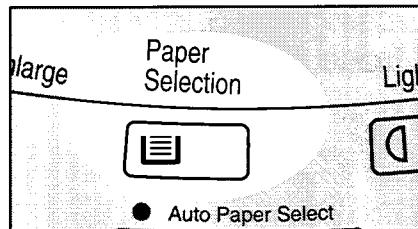

5 Set your original on the exposure glass or in the optional document feeder. See page 31, 32, or 34.

6 Press the **Start** key.

ERASING PARTS OF THE COPY IMAGE (Erase)

Note: The Erase key can instead be used as the Margin Adjustment key (☛ See page 127.) In this case, this function cannot be used.

Erasing The Center Margin Of The Original Image (Erase Center)

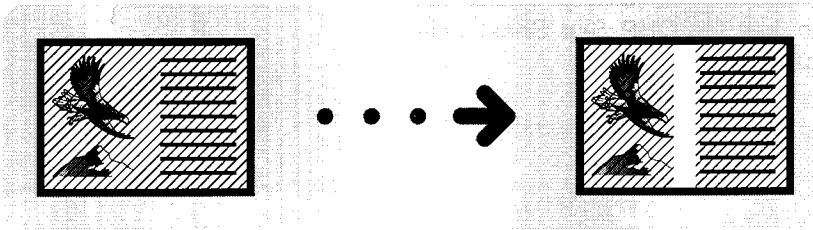

Erasing The Surrounding Area Of The Original Image (Erase Border)

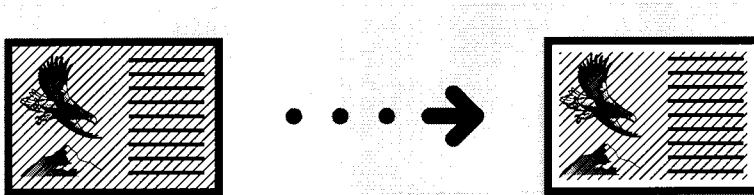

Erasing The Center Margin And Surrounding Area Of The Original Image

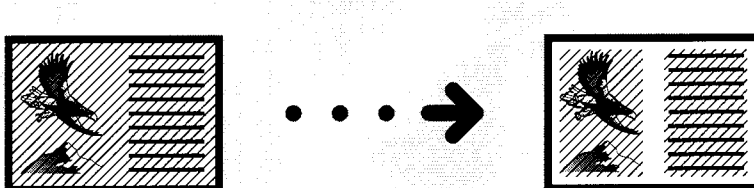

ERASING PARTS OF THE COPY IMAGE (Erase)

- The position of the margin to be erased is determined according to the selected copy paper and reproduction ratio. Make sure to select copy paper suitable for your original.
- The width of the margin to be erased can be changed with the user tools. ➤ See page 129.
- Regarding functions that cannot be used together with this function, ➤ see page 86.

- 1** Press the **Erase** key once to select the Erase Center, twice to select the Erase Border, or three times to select both of them.

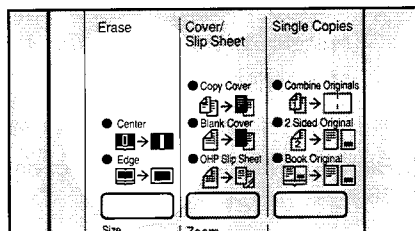

- 2** Set your original on the exposure glass or in the optional document feeder. ➤ See page 31, 32, or 34.

- If you place a book original on the exposure glass, the original must be aligned to the rear left corner.

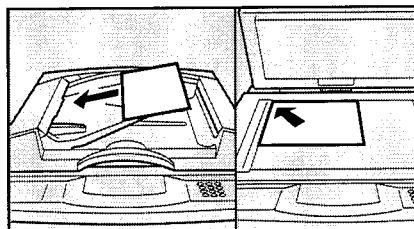

- 3** Press the **Start** key.

ADDING MARGINS FOR BINDING (Margin Adjustment)

Note: Before using Margin Adjustment, you have to change copier's default settings with the user tools. (☛ See page 127.) If you do this, the Erase key is used as the Margin Adjustment key. In this case, you cannot use the Erase function.

Note: After selecting Margin Adjustment, put the sticker (key name sheet) for Margin Adjustment on the operation panel. The sticker is enclosed as an accessory.

- The width of the margin can be changed with the user tools. ☛ See page 128.
- Regarding functions that cannot be used together with this function, ☛ see page 86.

Margin For One-sided Copying



- 1** Press the **Margin Adjustment (Erase)** key once to set the left margin or twice to set the right margin.

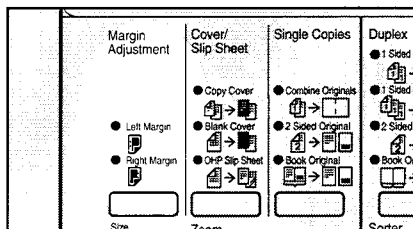

- 2** Make your copies.

Margin For Two-sided Copying

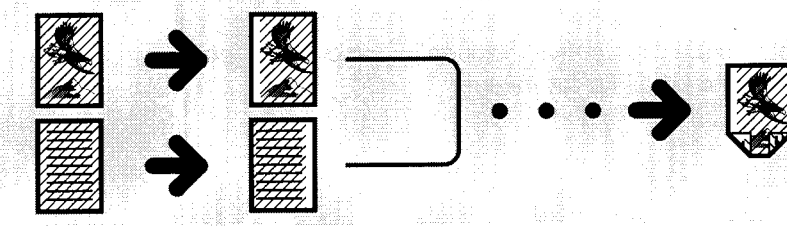

Note: This function can be used only when your copier has a unit for two-sided copying.

Follow the steps below when you want to set the left margin for the front side and right margin for the back side for binding when making two-sided copies that read from left to right.

- 1** Press the **Duplex** key to set the copier to make two-sided copies.
 - See pages 73 ~ 76.

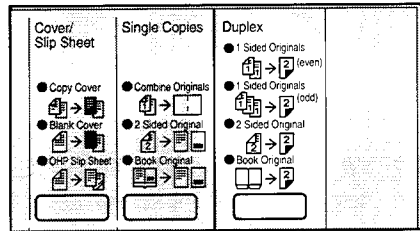

- 2** Press the **Margin Adjustment (Erase)** key once to set the left margin for the front side and the right margin for the back side.

- If you want to set the right margin for the front side and the left margin for the back side (binding for copies that read from right to left), press the **Margin Adjustment (Erase)** key twice.

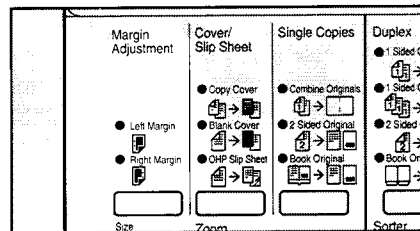

- 3** Make your copies.

COPYING

STORING YOUR COPY SETTINGS IN MEMORY (Program)

You can store up to five frequently used copy job settings in machine memory, and recall for future use.

Storing Your Settings

1 Set the copy settings you want to put into memory.

2 Press the **Program** key.

- If you want to cancel storing, press the **Program** key again.

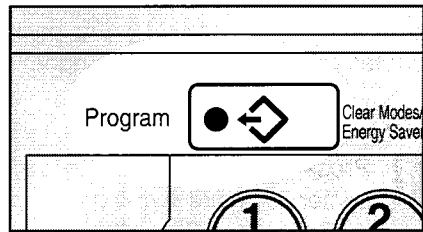

3 While pressing the **Recall/Enter** key, press the **Number** key (1, 2, 3, 4, or 5) that you want to store settings in.

- PE will be displayed on the copy counter if you select a protected program number. In this case, repeat steps 2 and 3 with another program number.
- If you want to protect your program, follow the procedure in the next section.

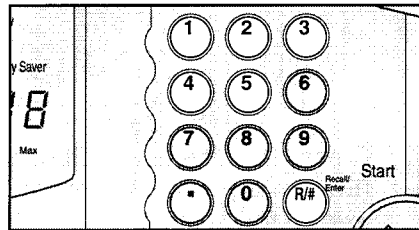

4 Release the **Recall/Enter** key.

Protecting Your Settings From Being Overwritten

1 Press the **Program** key.

2 While pressing the **Recall/Enter** key, press the **Number** key (1, 2, 3, 4, or 5) to be protected, then press the **Number** (0) key.

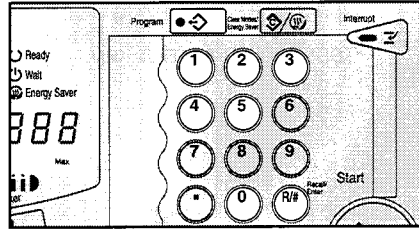

Recalling Your Settings

1 Press the **Program** key.

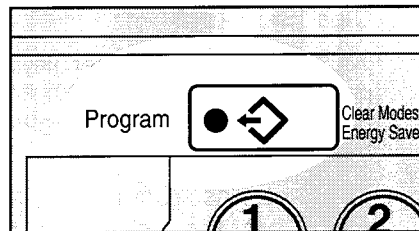

2 Enter the program number by pressing the **Number** key (1, 2, 3, 4, or 5).

- If you enter a program number not registered, **EP** will be displayed on the copy counter.
- If you recall a protected program number, **P1**, **P2**, **P3**, **P4**, or **P5** is displayed on the copy counter while holding the **Number** key.

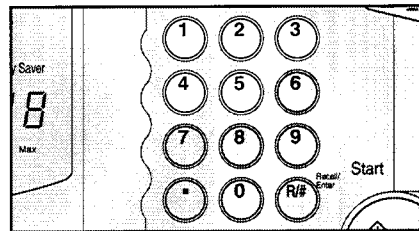

COPYING

Unprotecting Your Settings

- 1** Press the **Program** key.

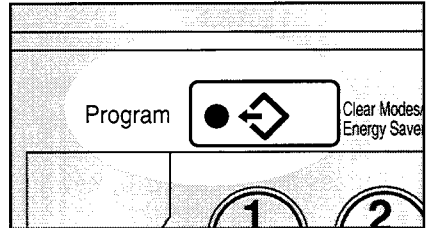

- 2** While holding the **Number** key (1, 2, 3, 4, or 5) that you want to remove protection from, press the **Clear/Stop** key.

- While holding the **Number** key, the program number (**P1**, **P2**, **P3**, **P4**, or **P5**) to be unprotected appeared in the copy counter.

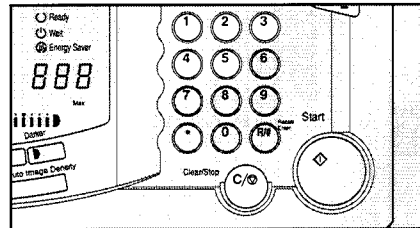

The settings remain as they were, but are no longer protected. You can store new settings under this number.

MAKING TWO-SIDED COPIES (ONLY WITH MODEL HAVING THIS FEATURE)

Note: This function can be used only if your copier has a unit for two-sided copying.

- To avoid problems caused by curly copies, try turning over the paper stack in the 250-sheet, 500-sheet, or large capacity tray. If there is no improvement, change to copy paper with less curl.
- The following paper limitations apply:
 - Maximum size: 11" x 17"
 - Minimum size: 5 1/2" x 8 1/2" sideways
 - Weight: 17 ~ 24 lb
 - *11" x 15" cannot be used.
- Up to 50 copies (17 ~ 20 lb paper) can be made at one time. If you use 21 ~ 24 lb paper, 30 copies can be made at one time.
- Regarding functions that cannot be used together with this function, see page 86.

From An Even Number Of One-Sided Originals (1 Sided Originals, even)

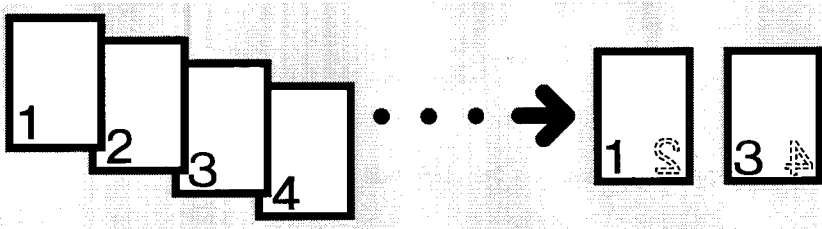

- A right margin of 0.2" is set on the back side automatically.
- If you select the Even Number setting when you have an odd number of originals, the first page of your copies will be blank, as shown in the illustration. Be sure to count your originals before copying.

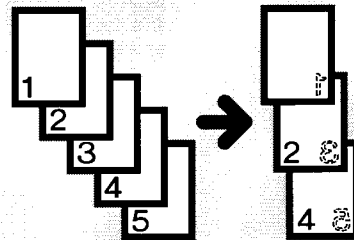

COPYING

MAKING TWO-SIDED COPIES (ONLY WITH MODEL HAVING THIS FEATURE)

1 Press the **Duplex** key to light the **1 Sided Originals (even)** indicator.

2 Set your original on the exposure glass or in the optional document feeder. See page 31, 32, or 34.

Start with the last page of the originals.

3 Press the **Start** key.

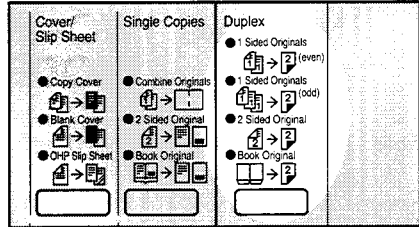

From An Odd Number Of One-Sided Originals (1 Sided Originals, odd)

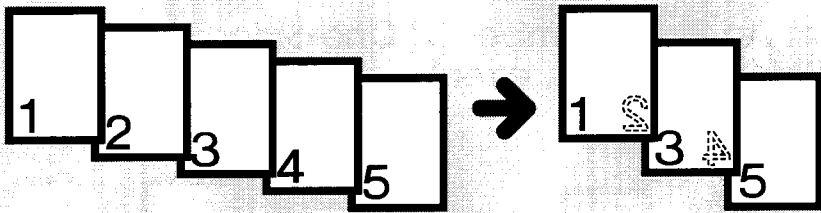

A right margin of 0.2" is set on the back side automatically.

If you select the Odd Number setting when you have an even number of originals, the first page of your copies will be blank, as shown in the illustration. Be sure to count your originals before copying.

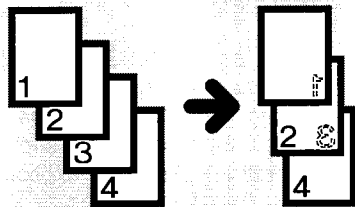

1 Press the **Duplex** key to light the **1 Sided Originals (odd)** indicator.

2 Set your original on the exposure glass or in the optional document feeder. See page 31, 32, or 34.

Start with the last page of the originals.

3 Press the **Start** key.

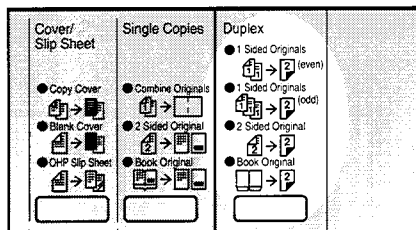

From Two-Sided Originals (2 Sided Original)

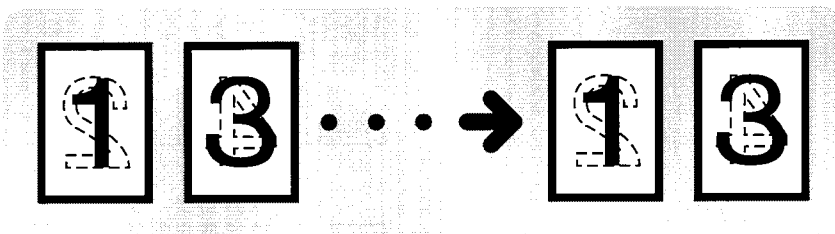

Note: It is recommended to use this function with the optional document feeder.

1 Press the **Duplex** key to light the **2 Sided Original** indicator.

2 Set your original in the optional document feeder. See page 32 or 34.

Start with the last page of the originals.

3 Press the **Start** key.

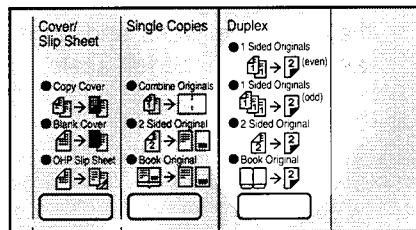

COPYING

From Facing Pages (Book Original)

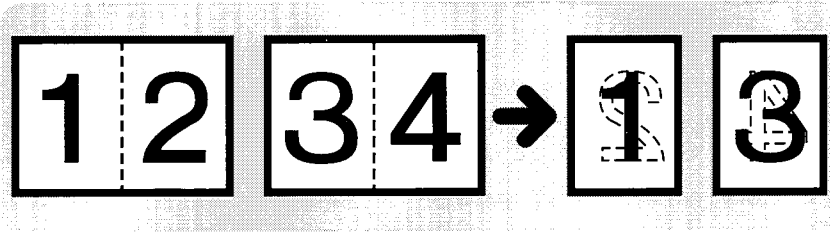

- Copy paper sizes (sideways only) that can be used are as follows:
8 1/2" x 11", 5 1/2" x 8 1/2"

- 1** Press the **Duplex** key to light the **Book Original** indicator.

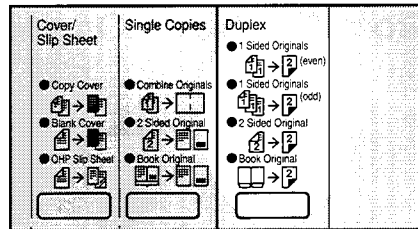

- 2** Start with the last page of your book original and work your way to the beginning.
Place the original face down on the exposure glass and align the last page with the left scale.

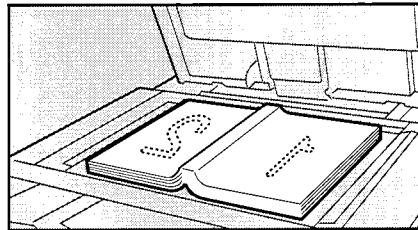

Or, set the facing original in the optional document feeder.

- 3** Press the **Start** key.

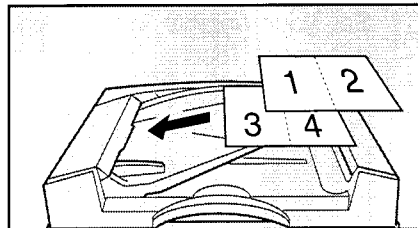

FINISHING (OPTION)

Sorting Into Sets (Sort)

One copy of each original is delivered to each bin and copies are collated into sets.

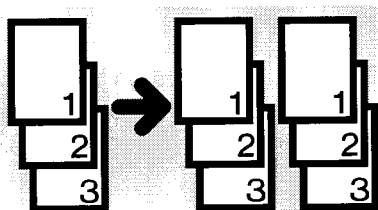

Note: This function can be used only when your copier is equipped with the optional 20-bin sorter stapler, 10-bin sorter stapler, 20-bin sorter, or 10-bin sorter.

For Sorting, the following limitations apply:

*L:lengthwise S:sideways

	20-bin sorter stapler	10-bin sorter stapler	20-bin sorter	10-bin sorter
Maximum paper size	L: 11" x 17" S: 8 1/2" x 11"	L: 11" x 17" S: 8 1/2" x 11"	L: 11" x 17" S: 8 1/2" x 11"	L: 11" x 17" S: 8 1/2" x 11"
Minimum paper size	8 1/2" x 11"	8 1/2" x 11"	L: 8 1/2" x 11" S: 5 1/2" x 8 1/2"	L: 8 1/2" x 11" S: 5 1/2" x 8 1/2"
Maximum paper weight	24 lb	42 lb	24 lb	24 lb
Minimum paper weight	14 lb	14 lb	14 lb	17 lb
Maximum capacity of bins	8 1/2" x 11": 30 copies 8 1/2" x 14" or larger: 15 copies	8 1/2" x 11": 30 copies 8 1/2" x 14" or larger: 25 copies	8 1/2" x 11" or smaller: 30 copies 8 1/2" x 14": 15 copies 11" x 17": 10 copies	8 1/2" x 11" or smaller: 20 copies: 8 1/2" x 14": 15 copies 11" x 17": 10 copies
Paper that cannot be used	post cards, translucent paper, OHP transparencies, and adhesive labels			

- To avoid problems caused by curly copies, try turning over the paper stack in the 250-sheet, 500-sheet, or large capacity tray. If there is no improvement, change to copy paper with less curl.
- Regarding functions that cannot be used together with this function, see page 86.

FINISHING (OPTION)

- 1** Press the **Sorter** key to light the **Sort** indicator.

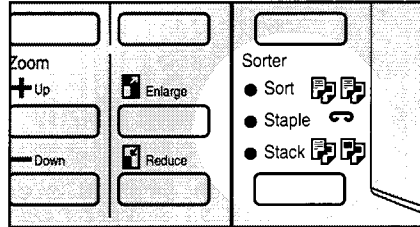

- 2** Set your original on the exposure glass or in the optional document feeder. See page 31, 32, or 34.

- 3** Set other settings and press the **Start** key.

- If you set your originals on the exposure glass in step 2, repeat steps 2 and 3 until your copying is completed.

Stapling Copies (Staple)

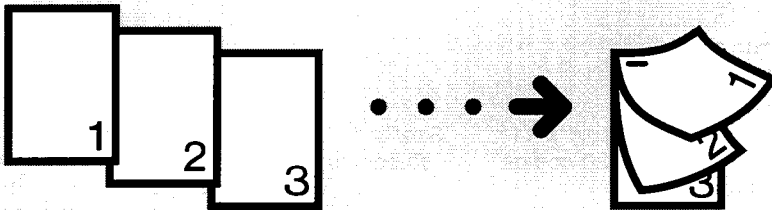

Note: This function can be used only when your copier is equipped with the optional 20-bin sorter stapler or 10-bin sorter stapler.

- If you select Stapling, Sorting is automatically selected.
- You cannot use Stapling with Stacking.
- To avoid problems caused by curly copies, try turning over the paper stack in the 250-sheet, 500-sheet, or large capacity tray. If there is no improvement, change to copy paper with less curl.
- Regarding functions that cannot be used together with this function, see page 86.

Stapling position and original setting

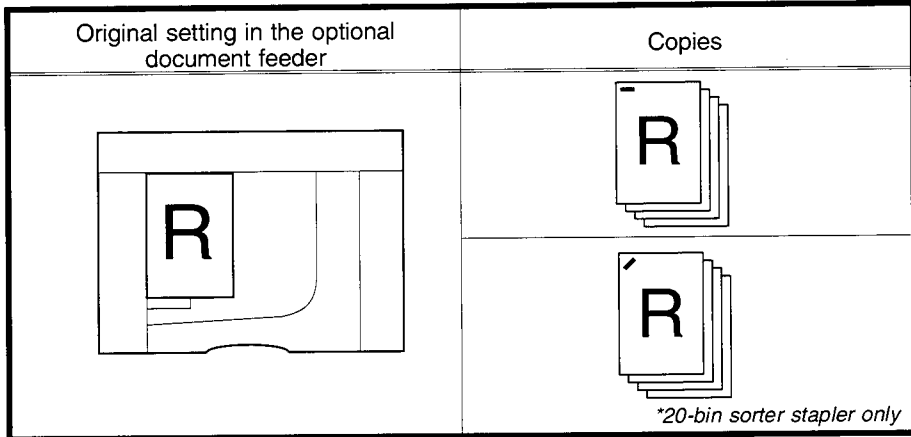

Changing the stapling position

If your machine is equipped with the 20-bin sorter stapler, you can select one of two stapling positions by changing the position of the stapler. Open the front cover of the sorter stapler and perform the actions illustrated below.

- After changing the position of the stapler, the stapler should be clicked in position.

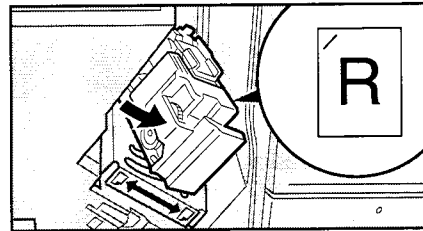
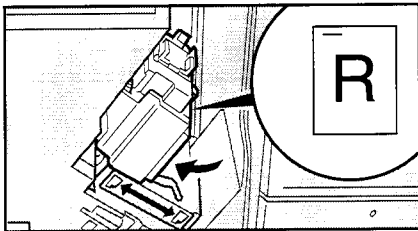

FINISHING (OPTION)

For Stapling, the following limitations apply:

*L:lengthwise S:sideways

	20-bin sorter stapler	10-bin sorter stapler
Maximum paper size	L: 11" x 17" S: 8 1/2" x 11"	L: 11" x 17" S: 8 1/2" x 11"
Minimum paper size	8 1/2" x 11"	8 1/2" x 11"
Maximum paper weight	21 lb	21 lb
Minimum paper weight	14 lb	14 lb
Stapler capacity	8 1/2" x 11": 2 ~ 20 copies 8 1/2" x 14" or larger: 2 ~ 10 copies	2 ~ 20 copies
Paper that cannot be used	post cards, translucent paper, OHP transparencies, and adhesive labels	

Stapling copies automatically after copying

Note: This function can be used only when your copier is equipped with the optional document feeder.

- 1** Press the **Sorter** key to light the **Staple** indicator.

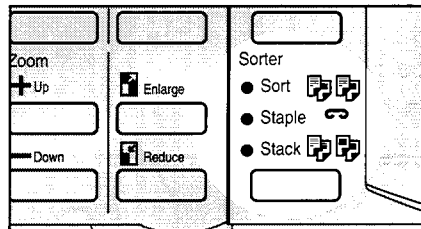

- 2** Set originals in the optional document feeder. See page 32.
- 3** Enter any other settings and make your copies.

Stapling copies manually after copying

Use this function when you place originals on the exposure glass, or in the optional document feeder, one sheet at a time.

- 1** Press the **Sorter** key to light the **Sort** indicator.

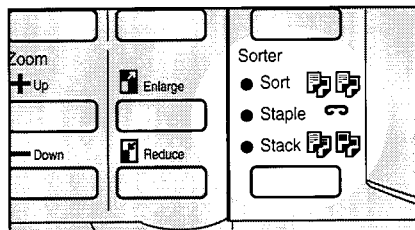

- 2** Place originals on the exposure glass, or set originals in the optional document feeder one sheet at a time.

- Start with the last page of the originals.

- 3** Make your copies.

- 4** After copying is completed, press the **Sorter** key before the **Staple** indicator stops blinking.

- The **Staple** indicator blinks for about 20 seconds. You can change this time using the user tools. See page 129.

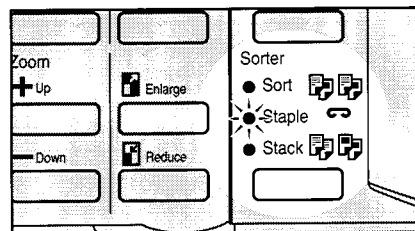

Stacking Together All Copies Of A Page (Stack)

All copies of each original are delivered to the same bin.

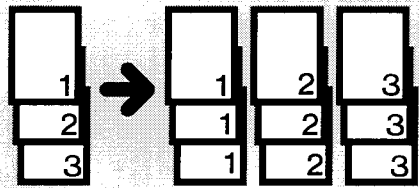

Note: This function can be used only when your copier is equipped with the optional 20-bin sorter stapler, 10-bin sorter stapler, 20-bin sorter, or 10-bin sorter.

- When using 11" x 17" paper with the 20-bin sorter stapler, it might happen that the sorter stapler cannot properly stack 15 sheets depending on the paper brand and condition.
- To avoid problems caused by curly copies, try turning over the paper stack in the 250-sheet, 500-sheet, or large capacity tray. If there is no improvement, change to copy paper with less curl.
- Regarding functions that cannot be used together with this function, see page 86.
- For Stacking, the following limitations apply: *L:lengthwise S:sideways

	20-bin sorter stapler	10-bin sorter stapler	20-bin sorter	10-bin sorter
Maximum paper size	L: 11" x 17" S: 8 1/2" x 11"	L: 11" x 17" S: 8 1/2" x 11"	L: 11" x 17" S: 8 1/2" x 11"	L: 11" x 17" S: 8 1/2" x 11"
Minimum paper size	8 1/2" x 11"	8 1/2" x 11"	L: 8 1/2" x 11" S: 5 1/2" x 8 1/2"	L: 8 1/2" x 11" S: 5 1/2" x 8 1/2"
Maximum paper weight	24 lb	42 lb	24 lb	24 lb
Minimum paper weight	17 lb	14 lb	14 lb	17 lb
Maximum capacity of bins	15 copies	8 1/2" x 11": 25 copies 8 1/2" x 14" or larger: 20 copies	8 1/2" x 11" or smaller: 30 copies 8 1/2" x 14": 10 copies 11" x 17": 10 copies	8 1/2" x 11" or smaller: 20 copies: 8 1/2" x 14": 15 copies 11" x 17": 10 copies
Paper that cannot be used	post cards, translucent paper, OHP transparencies, and adhesive labels			

- 1** Press the **Sorter** key to light the **Stack** indicator.

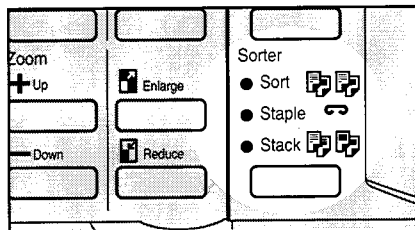

- 2** Set your original on the exposure glass or in the optional document feeder. See page 31, 32, or 34.
- 3** Enter any other settings and make your copies.

COPYING WITH USER CODES

- 1 Input your user code (3 digits) using the **Number** keys. Press the **Recall/Enter** key.

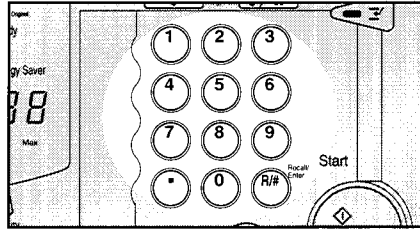

- 2 Make your copies.

- 3 To prevent from others from making copies using your user code, press the **Clear/Stop** and **Clear Modes/Energy Saver** key simultaneously after copying.

- Regarding user codes, see page 132.
- To set your copier for user codes, contact your service representative. See page 140.

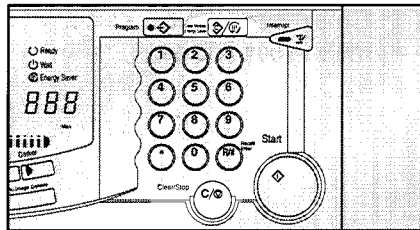

SAVING ENERGY

With the Energy Saver, the copier is reset and uses less electricity.

- To have the function turn on automatically or even have the copier turn itself off, set the user tools. ➤ See pages 124 and 125.
- Your service representative can select one of six levels for the saving ratio. (➤ See page 139.) The greater the saving ratio, the more time the copier will need to return to the ready condition.

1 Press the **Clear Modes/Energy Saver** key more than one second to enter the Energy Saver condition.

- All indicators except the  **Energy Saver** indicator turn off.

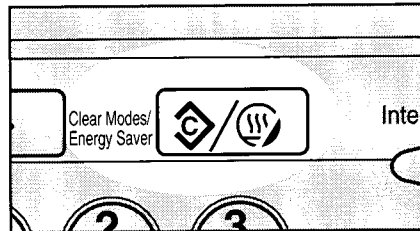

COMBINATION CHART

This combination chart shows which modes can be used together.

☆ means that these modes can be used together.

★ means that one of these modes will be selected automatically.

✗ means that these modes cannot be used together.

Mode you have selected \ Mode you try to select		Erase				Reduce/Enlarge				
		1	2	3	4	5	6	7	8	9
Erase	1 Erase Center		★	★	✗	☆	☆	☆	☆	☆
	2 Erase Edge	★		★	✗	☆	☆	☆	☆	☆
	3 Erase Center & Border	★	★		✗	☆	☆	☆	☆	☆
	4 Margin Adjustment	✗	✗	✗		☆	☆	☆	☆	☆
Reduce/Enlarge	5 Preset Reduce/Enlarge	☆	☆	☆	☆		★	★	★	★
	6 + – Zoom	☆	☆	☆	☆	★		★	★	★
	7 Size Magnification	☆	☆	☆	☆	★	★		★	✗
	8 Auto Reduce/Enlarge	☆	☆	☆	☆	★	★	★		★
	9 10 Key Zoom	☆	☆	☆	☆	★	★	✗	★	
Two-sided copies	10 From Even One-sided Originals	☆	☆	☆	☆	☆	☆	☆	☆	☆
	11 From Two-sided Originals	☆	☆	☆	☆	☆	☆	☆	☆	☆
	12 From Book Original	☆	☆	☆	☆	☆	☆	☆	✗	☆
	13 From Odd One-sided Originals	☆	☆	☆	☆	☆	☆	☆	☆	☆
One-sided copies	14 From Two-sided Original	☆	☆	☆	☆	☆	☆	☆	☆	☆
	15 From Book Original	☆	☆	☆	☆	☆	☆	☆	✗	☆
	16 From 2 One-sided Originals	☆	☆	☆	☆	☆	☆	☆	✗	☆
Finishing	17 Sorting	☆	☆	☆	☆	☆	☆	☆	☆	☆
	18 Stacking	☆	☆	☆	☆	☆	☆	☆	☆	☆
	19 Stapling	☆	☆	☆	☆	☆	☆	☆	☆	☆
Cover/Slip Sheet	20 Copied Front Cover	☆	☆	☆	☆	☆	☆	☆	☆	☆
	21 Blank Front Cover	☆	☆	☆	☆	☆	☆	☆	☆	☆
	22 OHP Slip Sheet	☆	☆	☆	☆	☆	☆	☆	☆	☆
Others	23 Auto Paper Select	☆	☆	☆	☆	☆	☆	☆	★	★
	24 Bypass Feed Copying	✗	✗	✗	✗	☆	☆	☆	✗	☆
	25 Interrupt Copying	☆	☆	☆	☆	☆	☆	☆	☆	☆
	26 Different Sized Originals in DF	☆	☆	☆	☆	☆	☆	☆	☆	☆

		Two-sided copies				One-sided copies			Finishing			Cover/Slip sheet			Others			
		10	11	12	13	14	15	16	17	18	19	20	21	22	23	24	25	26
Erase	1	☆	☆	☆	☆	☆	☆	☆	☆	☆	☆	☆	☆	☆	☆	✕	★	☆
	2	☆	☆	☆	☆	☆	☆	☆	☆	☆	☆	☆	☆	☆	☆	✕	★	☆
	3	☆	☆	☆	☆	☆	☆	☆	☆	☆	☆	☆	☆	☆	☆	✕	★	☆
	4	☆	☆	☆	☆	☆	☆	☆	☆	☆	☆	☆	☆	☆	☆	✕	★	☆
Reduce/Enlarge	5	☆	☆	☆	☆	☆	☆	☆	☆	☆	☆	☆	☆	☆	☆	☆	★	☆
	6	☆	☆	☆	☆	☆	☆	☆	☆	☆	☆	☆	☆	☆	☆	☆	★	☆
	7	☆	☆	☆	☆	☆	☆	☆	☆	☆	☆	☆	☆	☆	☆	☆	★	☆
	8	☆	☆	★	☆	☆	★	★	☆	☆	☆	☆	☆	☆	★	✕	★	☆
	9	☆	☆	☆	☆	☆	☆	☆	☆	☆	☆	☆	☆	☆	★	☆	★	☆
Two-sided copies	10		★	★	★	★	★	☆	☆	☆	☆	✕	✕	✕	☆	✕	★	✕
	11	★		★	★	★	★	★	☆	☆	☆	✕	✕	✕	☆	✕	★	☆
	12	★	★		★	★	★	★	☆	☆	☆	✕	✕	✕	✕	✕	★	☆
	13	★	★	★		★	★	✕	☆	☆	☆	✕	✕	✕	☆	✕	★	✕
One-sided copies	14	★	★	★	★		★	★	☆	☆	☆	✕	✕	✕	☆	☆	★	☆
	15	★	★	★	★	★		★	☆	☆	☆	✕	✕	☆	✕	✕	★	☆
	16	☆	✕	✕	✕	★	★		☆	☆	☆	✕	✕	✕	✕	✕	★	✕
Finishing	17	☆	☆	☆	☆	☆	☆	☆		★	☆	☆	☆	★	☆	✕	★	①
	18	☆	☆	☆	☆	☆	☆	☆	★		★	★	★	★	☆	✕	★	☆
	19	☆	☆	☆	☆	☆	☆	☆	☆	★		☆	☆	★	☆	✕	★	①
Cover/Slip Sheet	20	✕	✕	✕	✕	✕	✕	✕	☆	✕	☆		★	★	✕	★	★	✕
	21	✕	✕	✕	✕	✕	✕	✕	☆	✕	☆	★		★	✕	★	★	✕
	22	✕	✕	✕	✕	✕	☆	✕	✕	✕	✕	★	★		✕	★	★	✕
Others	23	☆	☆	★	☆	☆	★	★	☆	☆	☆	★	★	★		★	★	☆
	24	✕	✕	✕	✕	☆	✕	✕	✕	✕	✕	★	★	★	★		★	☆
	25	✕	✕	✕	✕	☆	☆	☆	✕	✕	✕	✕	✕	✕	☆	☆		☆
	26	✕	☆	☆	✕	☆	☆	✕	☆	☆	☆	✕	✕	✕	☆	☆	★	

①: These mode can be used only when you make copies with the same width.

COMBINATION CHART

Free Manuals Download Website

<http://myh66.com>

<http://usermanuals.us>

<http://www.somanuals.com>

<http://www.4manuals.cc>

<http://www.manual-lib.com>

<http://www.404manual.com>

<http://www.luxmanual.com>

<http://aubethermostatmanual.com>

Golf course search by state

<http://golfingnear.com>

Email search by domain

<http://emailbydomain.com>

Auto manuals search

<http://auto.somanuals.com>

TV manuals search

<http://tv.somanuals.com>