

SAVIN 9920/9925 DP

FAX Option Type 250

Operating Instructions

<Facsimile Reference (option)>

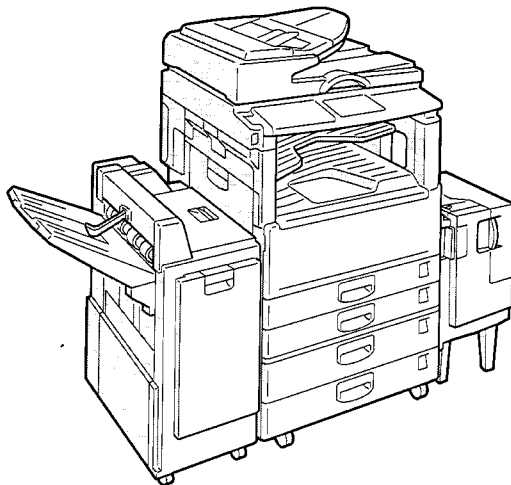

Caution

Use of controls, adjustments or performance of procedures other than those specified herein may result in hazardous radiation exposure.

Shielded interconnect cables must be employed with this equipment to ensure compliance with the pertinent RF emission limits governing this device.

Although this equipment can use either loop disconnect or DTMF signalling, only the performance of the DTMF signalling is subject to regulatory requirements for correct operation. It is therefore strongly recommended that the equipment is set to use DTMF signalling for access to public or private emergency services. DTMF signalling also provides faster call set up.

WARNING: This equipment has been tested and found to comply with the limits for a Class A digital device, pursuant to Part 15 of the FCC Rules. These limits are designed to provide reasonable protection against harmful interference when the equipment is operated in commercial environment. This equipment generates, uses and can radiate radio frequency energy and, if not installed and used in accordance with the instructions, manual may cause harmful interference to radio communications. Operation of this equipment in a residential area is likely to cause harmful interference in which case the user will be required to correct the interference at his expense.

CAUTION: Use of control or adjustments or performance of procedures other than those specified herein may result in hazardous radiation exposure.

Note

Some illustrations may be slightly different from your machine.
Certain options may not be available in some countries. For details, please contact your local dealer.

Notice about the Telephone Consumer Protection Act (Valid in USA only).

The Telephone Consumer Protection Act of 1991 among other things makes it unlawful for any person to send any message via a telephone fax machine unless such message clearly contains in a margin at the top or bottom of each transmitted page or on the first page of the transmission, the date and time it is sent and an identification of the business or other entity, or other individual sending the message and the telephone number of the sending machine or such business, other entity or individual. This information is transmitted with your document by the TTI (Transmit Terminal Identification) feature.

The telephone number provided may not be a 900 number or any other number for which charges exceed local or long distance transmission charges.

In order for you to meet the requirement, your machine must be programmed by following the instructions in the accompanying Operation Manual. In particular, please refer to the chapter of Installation. Also refer to the TTI (Transmit Terminal Identification) (programming procedure to enter the business identification and telephone number of the terminal or business. Do not forget to set the date and time.

Thank you.

ENERGY SAVING INFORMATION

As an Energy Star Partner, we have determined that this fax model meets Energy Star guidelines for energy efficiency.

This product was designed to reduce the environmental impact associated with fax equipment. This is accomplished by means of energy saving features such as Low Power (saving energy) mode and Night Timer. Please see applicable sections of operating manual for details.

Important Safety Instructions

In addition to the warnings and cautions included in the text of this manual, please read and observe the following safety instructions.

1. Read all of these instructions.
2. Save these instructions for later use.
3. Follow all warnings and cautions marked on the product.
4. Unplug this product from the wall outlet before cleaning. Do not use liquid cleaners or aerosol cleaners. Use a damp cloth for cleaning.
5. Do not use this product near water, for example, near a bath tub, wash bowl, kitchen sink or laundry tub, in a wet basement or near a swimming pool.
6. Avoid using a telephone (other than a cordless type) during an electrical storm. There may be a remote risk of electric shock from lighting.
7. Do not use a telephone in the vicinity of a gas leak to report the leak.
8. Do not place this product on an unstable cart, stand, or table. The product may fall, causing serious damage to the product or injuring the user.
9. Slots and openings in the cabinet and the back or bottom are provided for ventilation; to ensure reliable operation of the product and to protect it from overheating, these openings must not be blocked or covered. The openings should never be blocked by placing the product on a bed, sofa, rug, or other similar surface. This product should not be placed in a build-in installation unless proper ventilation is provided.
10. This product should be operated from the type of power source indicated on the marking label. Using a different power source may result in injury or accident. If you are not sure of the type of power available, consult an authorized sales person or your local power company.
11. This product is equipped with a 3-wire grounding type plug, a plug having a third (grounding) pin. This plug will only fit into a grounding-type power outlet. This is a safety feature. If you are unable to insert the plug into the outlet, contact your electrician to replace your obsolete outlet. Do not defeat the purpose of the grounding type plug. (This does not apply in countries in which the 2-wire, non-grounded type of plug is used.)
12. Do not allow anything to rest on the power cord. Do not locate this product where persons will walk on the cord.

13. If an extension cord is used with this product, make sure that the total of the ampere ratings on the products plugged into the extension cord does not exceed the extension cord ampere rating. Also, make sure that the total of all products plugged into the wall outlet does not exceed 15 amperes.
14. Never push objects of any kind into this product through cabinet slots as they may touch dangerous voltage points or short out parts that could result in a risk of fire or electric shock. Never spill liquid of any kind on the product.
15. Do not attempt to service this product yourself, as opening or removing covers may expose you to dangerous voltage points or other risks. Refer all servicing to qualified service personnel.
16. Do not take apart or attempt any modifications to this machine. There is a risk of fire, electric shock, explosion or loss of sight.

Please read the "SAFETY INFORMATION" section in the "General Reference" before using this machine.

Grounding

Ground the machine and the lightning protection circuit in accordance with regulations. Do not ground to gas or water pipes, or to a telephone ground plug. Proper grounding is to the ground terminal of the power outlet. Be sure that the ground terminal of the power outlet is properly grounded.

The lightning protection circuit for the machine requires the machine to be properly grounded. If proper grounding is provided, about 90% of lightning damage can be prevented. For safety, be sure to connect the machine to a three-prug grounded outlet.

Cold Weather Power-up

Avoid raising the room temperature abruptly when it is below 57°F(14°C), or condensation may form inside the machine.

1. Raise the room temperature to 68°F(20°C) at less than 18°F(10°C) per hour.
2. Wait for 30 to 60 minutes.
3. Turn the power on.
4. Do not use the machine near a humidifier.

Thunderstorms

With proper grounding, about 90% of lightning damage can be prevented. However, if possible, during severe electric storms turn the power switch off and disconnect the power cord and telephone line cord.

General

1. Since some parts of the machine are supplied with high voltage, make sure that you do not attempt any repairs or attempt to access any part of the machine except those described in this manual.
2. Do not make modifications or replacements other than those mentioned in this manual.
3. When not using the machine for a long period, disconnect the power cord.

SYMBOLS AND CONVENTIONS

Conventions

IMPORTANT

Instructions designed to prevent paper jams, damage to originals, or loss of data. Be sure to read this information.

Before operation

Tips on what to do before you start.

HINT

Advice about a particular operation or how to correct a mistake.

Restriction

Numerical limits, functions that cannot be combined or conditions in which a particular function is disabled.

Cross-reference

Tells you where you can find related information.

[Exit]

Words enclosed in square brackets refer to the four buttons at the base of the display. For example “Press [Exit]” means press the button directly below the word “Exit” on the display.

Boldface

Boldface is used to refer to keys on the operation panel (except for the four keys under the display).

FUNCTION MAP

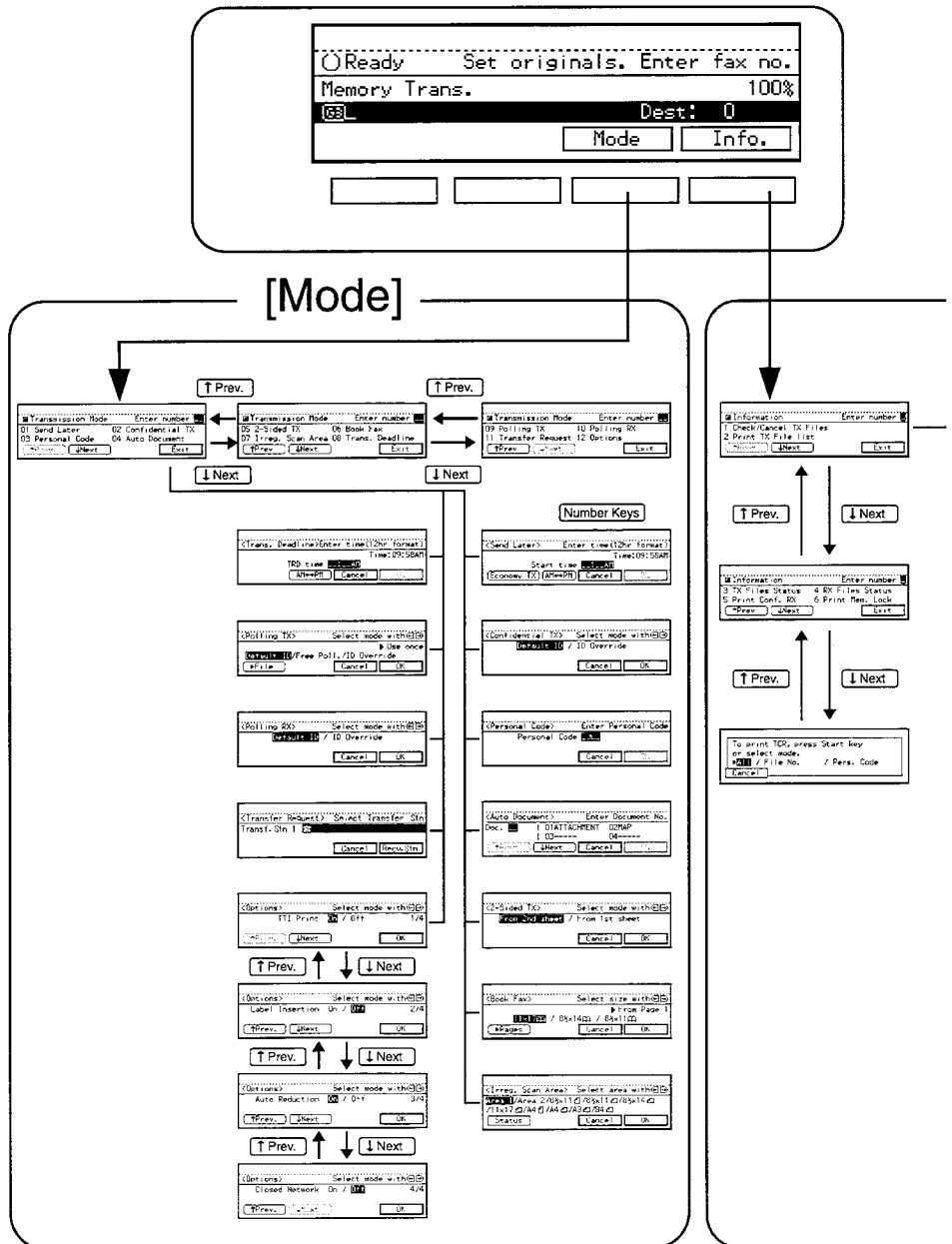

[Info.]

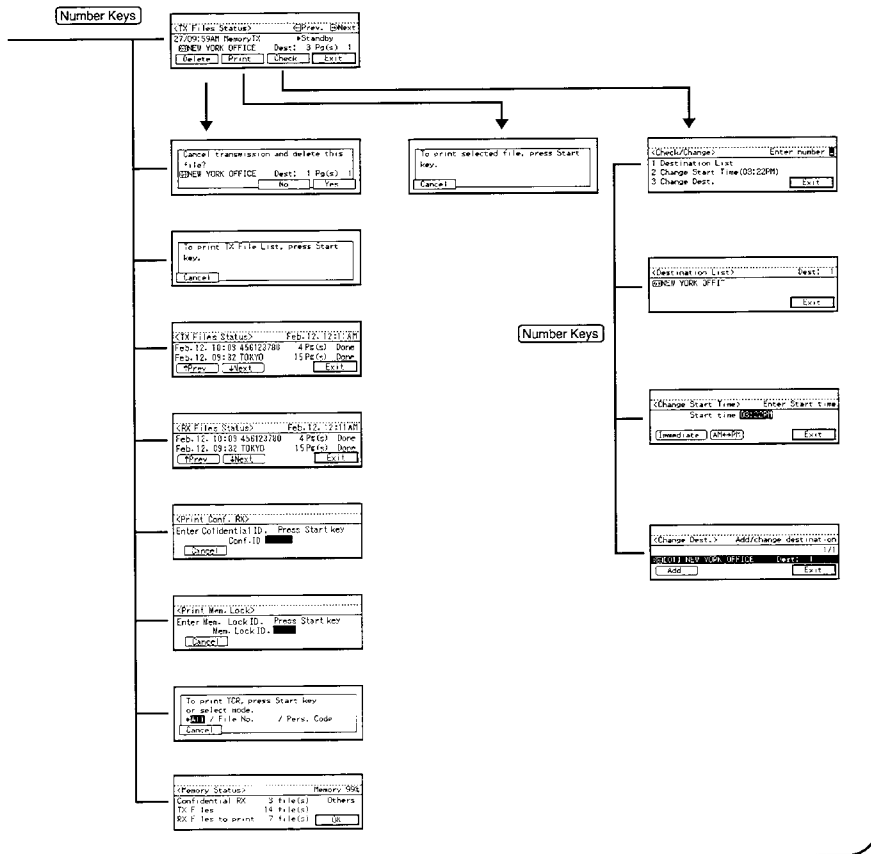

TABLE OF CONTENTS

SYMBOLS AND CONVENTIONS	1
Conventions	1
FUNCTION MAP	2

Getting Started

GUIDE TO COMPONENTS	10
OPERATION PANEL	12
READING THE DISPLAY	14
USEFUL FUNCTIONS	16
Auto Power-On Reception	16
Transmission With Image Rotation	17
ACCEPTABLE TYPES OF ORIGINALS	18
HOW TO SET AN ORIGINAL	21

Sending a Fax Message

Overview	26
MEMORY TRANSMISSION	27
IMMEDIATE TRANSMISSION	34
On-hook Dial (not available in some countries)	37
Manual Dial (handset option required)	38
SCAN SETTINGS	39
Resolution	39
Original Type	40
Image Density (Contrast)	41
Mixing Scan Settings In A Multiple Page Original	42
CHANGING LINE TYPE (OPTIONAL ISDN UNIT REQUIRED)	43
DIALING	45
Number Keys	45
Quick Dial	50
Speed Dial	51
Groups	54
Optional Group Dial (Function Upgrade Card Required)	55
Redial	56

TRANSMISSION FEATURES	58
Stamp	58
ID Transmission	59

Receiving a Fax Message

IMMEDIATE RECEPTION	62
MEMORY RECEPTION	63
Substitute Reception	64
SELECTING THE RECEPTION MODE	66
Fax Mode (Auto Reception Mode)	66
Telephone Mode	66
RECEPTION FUNCTIONS	67
Transfer Station	67
ID Reception	68
PRINTING FUNCTIONS	69
Print Completion Beep	69
Checkered Mark	69
Center Mark	70
Reception Time	70
Multi-copy Reception (Memory Card Or Hard Disk Option Required)	71
2-Sided Printing (Optional Duplex Tray And Memory Card Or Hard Disk Required)	71
Image Rotation	72
Two In One	72
Page Separation and Length Reduction (not available in some countries)	73
Reverse Order Printing	73
Page Reduction	74
TSI Print	74
CIL/TID Print (ISDN unit required)	74
When There Is No Paper Of The Correct Size	75

Advanced Transmission Features

SEND LATER	78
CONFIDENTIAL TRANSMISSION	80
PERSONAL CODE TRANSMISSION	83

SENDING AN AUTO DOCUMENT	85
2-SIDED TRANSMISSION (DOUBLE-SIDED TRANSMISSION)	87
BOOK FAX	88
CHOOSING THE AREA TO BE SCANNED YOURSELF (IRREGULAR SCAN AREA)	90
TRANSMISSION DEADLINE (TRD)	92
POLLING TRANSMISSION	94
POLLING RECEPTION	98
TRANSFER REQUEST	101
TRANSMISSION OPTIONS	105

Communication Information

CHECKING AND CANCELING TRANSMISSION FILES	110
Canceling A Transmission	110
Printing A File	111
Checking And Editing A File	112
PRINTING A LIST OF FILES IN MEMORY (PRINT TX FILE LIST)	116
CHECKING THE TRANSMISSION RESULT (TX FILE STATUS)	117
CHECKING THE RECEPTION RESULT (RX FILE STATUS)	118
PRINTING A CONFIDENTIAL MESSAGE (MEMORY CARD OR HARD DISK REQUIRED)	119
PRINTING A FILE RECEIVED WITH MEMORY LOCK (MEMORY CARD OR HARD DISK OPTION REQUIRED)	121
PRINTING THE TCR	123
DISPLAYING THE MEMORY STATUS	125

Troubleshooting

ERROR MESSAGES AND THEIR MEANINGS	128
SOLVING PROBLEMS	130
INDICATORS	131
When The Receive File Indicator Is Lit Or Flashing	131
When The <input checked="" type="checkbox"/> (Confidential Reception) Indicator Is Lit	132
When The Fax Error Indicator Is Lit	132
WHEN AN ERROR REPORT IS PRINTED	133
WHEN POWER IS TURNED OFF OR FAILS	133

User Tools

ACCESSING THE USER TOOLS	136
REGISTER/DELETE MENU	138
Registering Quick Dials	138
Deleting Quick Dials	140
Registering Groups	141
Deleting Groups	144
Registering Optional Groups (Function Upgrade Card Option Rrequired)	145
Deleting Optional Groups	148
Registering Speed Dials	149
Deleting Speed Dials	151
Storing Keystroke Programs	152
Deleting A Keystroke Program	155
Registering Auto Documents	157
Deleting An Auto Document	159
Registering Irregular Area	160
Deleting An Irregular Area	162
REPORTS/LISTS	164
INITIAL SETUP TX	165
INITIAL SETUP RX	166
ASSIGNING USER FUNCTION KEYS	167
KEY OPERATOR SETTINGS	169
Personal Codes	169
ECM	174
Memory Lock (Memory Card or Hard Disk Option Required)	174
Multistep Transfer (Optional Memory Card or Hard Disk Required)	175
Forwarding	177
Receiving From The Senders To Treat Differently (Special RX Nos.)	183
Authorized Reception	188
Monitor Volume	192
RTI/TTI	193
Registering The Economy Transmission Time	195
ID Code	196
G3 Analog Line	197
G3 Digital Line	199
G4 Digital Line	200

Changing The User Parameters	203
Printing The User Parameter List	207
Date/Time	207
Daylight Saving Time (Summer Time)	209
Counters	209
Paper Feed Selection	209
RDS (Remote Diagnostic System)	210

Entering Text

ENTERING AND MODIFYING TEXT	212
Available Characters	212
Keys	212
How To Enter Text	214

Maintaining Your Machine

CONNECTING THE MACHINE TO A TELEPHONE LINE AND TELEPHONE ...	218
Connecting The Telephone Line	218
Connecting The Machine To The ISDN	218
Connecting The Optional Telephone Handset	219
Selecting The Line Type	219
REPLACING THE STAMP CARTRIDGE	220

Appendix

OPTIONAL EQUIPMENT	A-3
Memory Card	A-3
Function Upgrade Card	A-3
400dpi High Resolution Card	A-3
ISDN Unit	A-3
SPECIFICATIONS	A-4
FUNCTION LIST	A-5
INDEX	A-10

Getting Started

Getting Started

GUIDE TO COMPONENTS

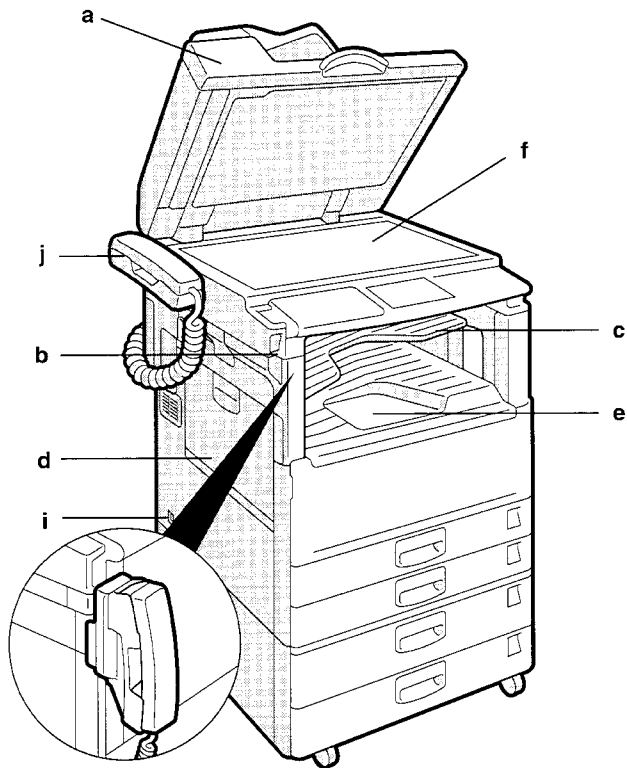

a. ADF/ARDF/Platen Cover

Holds down the original placed on the exposure glass.

b. Main Switch *1

Use to turn the machine on or off.

⇒ See "Auto Power-On Reception" on page 16.

⇒ See "When Power is Turned Off" on page 133.

c. Internal 1-bin Tray (internal tray 2)

Usually received fax messages are printed to the Internal Tray 1.

Other tray can also be selected for other prints or copies.

⇒ See "CHANGING MACHINE SETTINGS" in the General Reference.

d. External Tray

e. Internal Tray 1

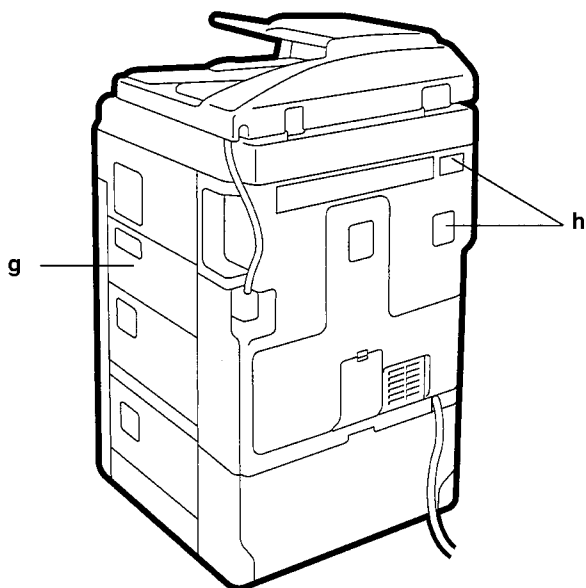



- f. Exposure Glass**
Place the original aligning its upper left corner with the reference mark at the upper left corner of the exposure glass.
- g. Bypass Tray**
Select this tray to use non-standard size paper.
⇒ See "Setting Originals" in the Copy Reference.
- h. Line Connectors**
- i. AC Switch *1 *2**
Do not touch this switch. It should only be used by a service engineer.
- j. Handset**
This permits voice communication.

*1 If the main switch is on and there is still no power, turn on the AC switch.

*2 If you leave the AC switch off for more than about an hour without optional hard disk, all files in memory are lost.

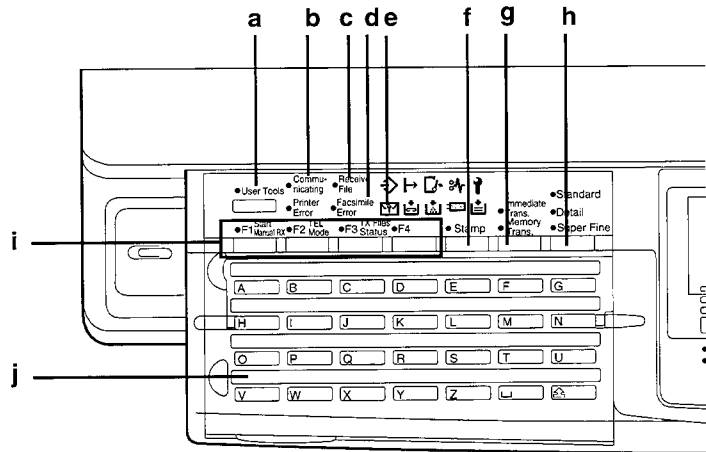
OPERATION PANEL



- a. User Tools**
Press to enter User Tools mode. These tools allow you to customize the default settings.
- b. Communicating Indicator**
Lights during transmission or reception.
- c. Receive File Indicator**
Lights to tell you a message has been received into memory. Blinks when a Memory Lock file has been stored in memory. Note that this indicator does not inform you of a Confidential reception.
- d. Facsimile Error Indicator**
Lights if the optional Facsimile unit has problem, there is a communication error or there is no paper in the cassette (see page 132).
- e.  (Confidential Reception) Indicator**
Lights when a message has been received into memory with Confidential Reception (see page 119, 132).
- f. Stamp key**
Press to turn the stamp feature on or off..
- g. Transmission Mode key**
Press to toggle between Memory Transmission and Immediate Transmission modes.
- h. Resolution key**
Press to switch between Standard, Detail and Super Fine (optional high resolution card required).

i. User Function keys

Each of these can be programmed for rapid access to frequently used features.

Features Programmed by Default

Key	Standard	With G4 option
F1	Start Manual RX	←
F2	TEL Mode	←
F3	Transmission Result Display	←
F4	–	G4 selection

j. Quick Dial keys

Use to dial numbers at a single touch or to enter letters and symbols. Also use for Group Dial, Keystroke Program and Auto Document features.

Quick Dial Flip Plate

Flip this plate down to access Quick Dial keys 01 through 28, flip up to access keys 29 through 56.

k. Original Type key

Use when sending a halftone image such as a photograph or a color original.

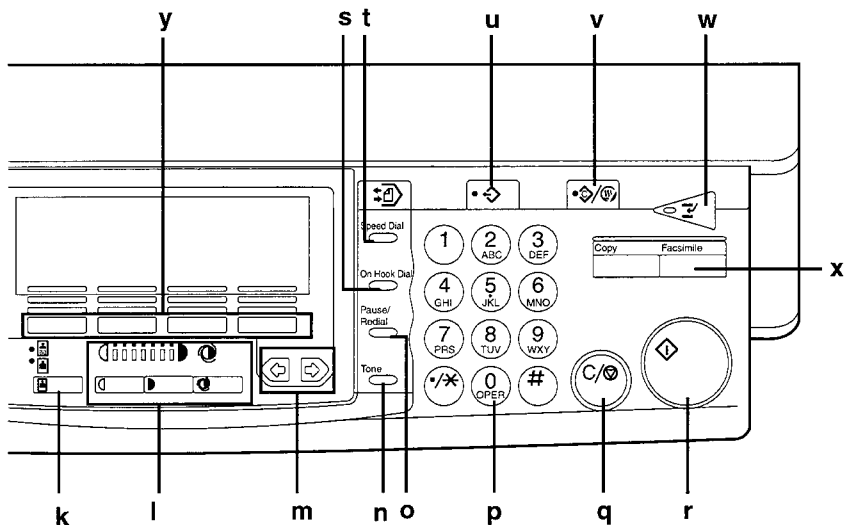

- l. Density key (Contrast key)**
Press this key to adjust the density manually.
- m. ← → keys**
Press to move the cursor or select functions
- n. Tone key**
Press to send tonal signals down a pulse dialing line.
- o. Pause/Redial key**
Pause: Inserts a pause when you are dialing or storing a fax number. A pause cannot be inserted as the first digit.
Redial: Press to redial one of the last ten numbers.
- p. Number Keys**
Use to dial fax numbers or enter the number of copies.
- q. Clear/Stop key**
Clear: Deletes one character or digit
Stop: Interrupts the current operation (transmission, scanning, copying or printing).
- r. Start Key**
Press to start all tasks.
- s. On Hook key**
Use for making a phone call from the keypad. You do not have to lift the handset.
- t. Speed Dial**
Press to select a Speed Dial.
- u. Program key**
This key is used in Copier mode.
- v. Clear modes/Energy saver**
Energy saver: Hold down for more than a second to enter energy saving mode.
Clear modes: Cancels the current setting and returns to standby with a single keystroke.
- w. Interrupt key**
Interrupts the current fax operation to start copying.
- x. Facsimile key**
Press to switch to fax mode.
- y. Selection keys**
Press these keys to make function selections.

READING THE DISPLAY

The display tells you the machine status and guides you through operations.

- Functions that have been selected are shown white on black (e.g. **11x17**). Keys that you can not select are shown with a dashed outline (e.g. **Energy**).
- **All procedures in this manual assume you are in Fax mode. By default, when you turn the machine on it is in Copy mode. Press the Fax key change to Fax mode. If you wish the machine to start in Fax mode, see “CHANGING THE MACHINE’S SETTINGS” in the General Reference manual.**

Standby display

While the machine is in the standby mode (immediately after it is turned on), the following display is shown.

◆Memory Transmission (Initial Display):

○ Ready		Set originals. Enter fax no.	
Memory Trans.		100%	
03	Dest: 0		
Mode		Info.	

HINT

- To return the machine to standby mode, perform one of the following:
 - If you have set an original and are in the sending process, remove the original.
 - If you have not set an original and are in the sending process, press the **Clear modes/Energy saver** key.
 - If you are in User Tools mode, press the **User Tools** key.

◆Immediate Transmission:

○ Ready		Set originals. Enter fax no.	
Immediate TX		100%	
03	Dest: 0		
Mode		Info.	

◆Display During Memory Transmission or Memory Reception:

PARIS BRANCH		A4 → A4	P001/P003
○ Ready Set originals. Enter fax no.			
Memory Trans.		100%	
Dest: 0			
Mode		Info.	

Hint

- Even when the machine is sending or receiving a fax message from/into memory, you can still scan the next original into memory. ⇒ See “Dual Access” on page 16.

◆Immediate Transmission:

Transmitting		Page 1
7945651596578		Dest:3
*Press Stop key to cancel TX		

Display prompts

Depending on the situation, the machine will show various prompts on the display.

◆Instructions and Requests

<Send Later> Enter time (24hr format)	
Time:01:23	
Start time	■:■:■
Economy TX	Cancel

◆Questions

Do you want to register a Wildcard ?	
Yes	No

◆Selections

<Book Fax> Select size with	
▶ From Page 1	
11x17 / 8x14 / 8x11	
▶Pages	Cancel

◆Status

Dialing	
Page 0	
100%	
@[01] NEW YORK OFFICE	
*Press Stop key to cancel TX	

Auto Power-On Reception

To save on power costs, turn off the main switch when the machine is not used for long periods of time, such as at night or during holidays.

Even if the main switch is turned off, the machine can still send from memory, receive or print fax messages as long as the AC switch is turned on.

By default, the machine will immediately print any messages it receives while the main switch is off. If you wish, you can choose to have messages stored in memory and then printed when you turn the main switch back on (see User Parameters, page 203).

IMPORTANT

- When both the main and AC switches are off, and reception is disabled.

Dual Access

The machine can even while sending a fax message from memory, automatically print a report, or scan other messages into memory. Since the machine starts sending the second message immediately after the current transmission terminates, the line will be used efficiently.

Note that during Immediate Transmission or when in User Tools mode, the machine cannot scan an original.

Personal Code Access

The machine can be set up so that nobody can use it without entering a personal code. This prevents unauthorized people from sending fax messages and can be used to track Fax machine use by giving a personal code to each user.

Hint

- Register personal codes and turn Personal Code Access on with the User Tools (see User Parameters, page 203). The default setting is off.
- Even if Personal Code Access is enabled, the machine can receive and print a fax message. Personal codes appear on reports as "*****".

Entering a Personal Code

- 1** If Personal Code Access is turned on, the display is shown as opposite:

<Fax> Personal Code Access.
Please enter your Personal Code.
Personal Code: []

- 2** Enter a personal code (4-digit number) using the number keys.

<Fax> Personal Code Access.
Please enter your Personal Code.
Personal Code: 082

Hint

- If a user enters a personal code that is not registered, the machine returns to step 1.

Transmission With Image Rotation

For most purposes, set A4/LT originals in the lengthwise direction (☐). If you set an A4/LT original in the sideways direction (☐), the image will be sent rotated by 90°. Providing the receiver has A4/LT lengthwise paper (☐), the message will be printed the same size as the original.

Hint

- If you wish to set the original in A4/LT sideways direction (☐), set the original upside down. The TTI will be printed on the upper of the received fax message.
- When Image Rotation is used, all messages are sent by normal Memory Transmission.

ACCEPTABLE TYPES OF ORIGINALS

If you set an original containing wet ink or correcting fluid, the exposure glass will be marked and copies will be affected. To avoid this, make sure your originals are dry.

Acceptable Original Sizes

Name	Size	Number of sheets	Paper thickness
Exposure glass	Maximum A3☐ (297 × 420 mm), 11" × 17"☐ (279 × 432 mm)	—	—
ADF/ARDF	Fax transmission: A5☐ to A3☐ (up to 1200 long) 8½" × 5½"☐ to 11" × 17"(DLT)☐	30 sheets	52~105g/m ² (45~90kg)

Restriction

- When using the 2-sided Transmission, the minimum original size is B5/HLT and the maximum original length is 432mm/17".

Unacceptable Paper for the ADF/ARDF

- If originals in any of the following conditions are placed in the ADF, they may be damaged. Place them on the exposure glass.
 - Originals of sizes other than those specified above table
 - Originals containing staples or clips
 - Perforated or torn originals
 - Curled, folded, or creased originals
 - Pasted originals
 - Originals with any kind of coating, such as thermosensitive paper, art paper, aluminum foil, carbon paper, or conductive paper
 - Originals with indexes, tags, or other projecting parts
 - Sticky originals such as translucent paper
 - Thin and soft originals
 - Originals of inappropriate weight (⇒ See the above table.)
 - Originals in bound form such as books
 - Transparent originals such as OHP transparencies or translucent paper
 - Originals of in appropriate weight

Restriction

- Do not use different sizes of original in the same transmission.

Originals whose sizes are difficult to detect

- If originals in any of the following conditions are sent, the size is difficult to detect. The receiving machine may not select paper of the correct size.
 - Originals with indexes, tags, or projecting parts
 - Transparent originals such as OHP transparencies or translucent paper
 - Dark originals with many characters or drawings
 - Originals which partially contain solid printing
 - Originals which have solid printing at their edges
 - Originals other than those (with ○) in the tables below.
- The following paper sizes are automatically detected (in fax mode)

Paper size	A3	B4	A4	B5	A5	A5	B6	11"x17"	8 1/2"x14"	8 1/2"x11"	8 1/2"x5 1/2"	8 1/2"x5 1/2"
Where original is placed	☐	☐	☐☐	☐☐	☐	☐	☐☐	☐	☐	☐☐	☐	☐
Exposure glass	○	○	○	○	×	×	×	○	○	○	×	×
ADF/ARDF	○	○	○	○	○	○	×	○	○	○	○	○

Restriction

- When using 2-sided transmission, A5 and HLT can not be available.

Paper Size and Scanned Area

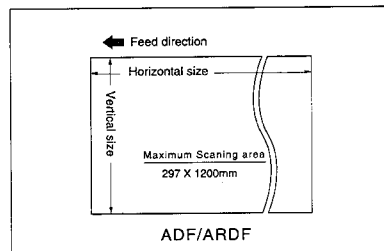
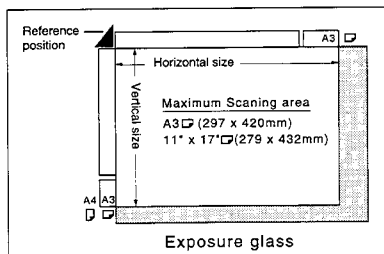

Restrictions

- There may be a difference in the size of the image when it is printed at the destination.
- If an original larger than DLT/A3 is placed on the exposure glass, only the DLT/A3 area is scanned.

Hint

- Even if an original is correctly placed on the exposure glass or in the ADF/ARDF, a margin of 3mm around each edge of the original may not be sent.
- If the receiver uses paper narrower than the original, the image will be reduced to fit the paper width.

- ❑ If an original larger than the above maximum scanning area, do one of the following.
 - Change the user parameter (see page 203)
 - Specify the irregular scan area (see page 160)

The machine detects paper sizes in the following ways:

- ❑ When you set an original in the ADF/ARDF, an original wider than about 7.48" is scanned as LT/LG size wide. An original wider than about 10.43" is scanned as DLT size. Originals narrower than 7.48" will be sent as LT/LG size. Originals up to 47.24" in length can be scanned.
 - ❑ When you set an original on the exposure glass, an original narrower than about 9.25" is scanned as LT/LG size wide. Originals wider than 10.83" are scanned as DLT size. Normally, lengths up to a maximum of 17" can be scanned (this figure varies slightly depending on the type of original). If you select Irregular Scan Area, lengths up to 17" are possible.
1. The maximum scan area for Memory Transmission is 297 mm × 432 (A3), 11" × 17"(DLT) mm.
 2. Immediate Single-sided Transmission from the ADF/ARDF, check the table below.

Width	Length		
	Resolution	Without 400dpi High Resolution Card	With 400dpi High Resolution Card
LT/LG	Standard	47.24"	47.24"
	Detail	16.69"	47.24"
	Fine	Not available	47.24"
	Super Fine	Not available	23.62"
DLT	Standard	31.5"	47.24"
	Detail	17"	47.24"
	Fine	Not available	31.5"
	Super Fine	Not available	17"

3. When sending from the exposure glass, the maximum scan area is 11" × 17"(DLT) 297 mm × 432 (A3) mm.

HOW TO SET AN ORIGINAL

In this manual an original can mean a single or multiple page document. You can set your originals either in the ADF (Auto Document Feeder), ARDF (Auto Reverse Document Feeder) or on the exposure glass. Some types of originals are unsuitable for the ADF so they must be set on the exposure glass (see “Acceptable Types of Originals” on page 18).

Which way you place your original depends on its size and whether you are using the ADF/ARDF or the exposure glass. Check the diagrams below.

Hint

- ❑ When sending a fax, the image output at the other end depends on the size and direction of paper used in the receiver’s terminal. If the receiver does not use paper of the same size and direction as that of the original, the fax image may be output reduced, trimmed at the both edges, or divided into two or more sheets. When sending an important original, we recommend you to ask the receiver about the size and direction of the paper used in their terminal.
- ❑ When sending an original of a irregular (non-standard) size or part of a large original, you can specify the scan area precisely (see “Specifying an Irregular Scan Area” on page 160).

◆How to set A4, B4, A3, LT, LG or DLT size originals:

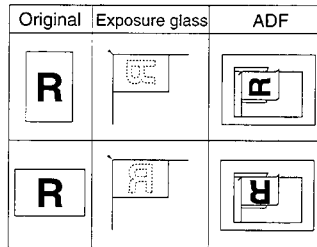

Hint

- If you set an A4/LT original using the sideways direction(↻), it is sent rotated by 90 degrees ⇒ see “Transmission with Image Rotation” on page 17.
If you set the original upside down as shown in the diagram, the TTI will appear on the top of the image at the destination ⇒ see “TTI print” on page 105.

◆How to set A5 or B5 size originals:

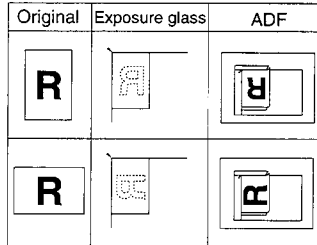

Setting a Single Page on the Exposure Glass

Set originals that cannot be placed in the ADF on the exposure glass one page at a time.

- 1** Lift the platen cover or ADF by at least 30 degrees. Place the original face down and align its upper left corner with the reference mark at the upper left corner of the exposure glass.

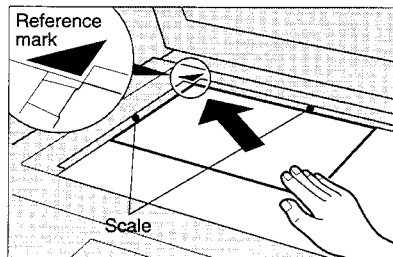

Hint

- If you do not raise the platen cover/ADF by at least 30 degrees the original size will not be detected.

2

Close the platen cover or ADF.

Hint

- When sending a bound original, the received image may contain some black areas. To reduce this effect, hold down the original to prevent its bound part from rising.

Setting an Original in the ADF/ARDF

Multiple page originals can be placed in the ADF/ARDF. The ADF can scan single-sided originals only. The ARDF, however, can handle either single-sided or 2-sided original (double-sided originals).

Restrictions

- Place all the originals to be sent in the ADF/ARDF all at once. When sending a fax, the originals cannot be placed in the ADF/ARDF one by one or in sheaves.
- In some cases, the scanning speed may be slower.

Hint

- When setting pages longer than A3 (420mm)/DLT (17") in the ADF/ARDF, guide them in with your hand. If you press down on the original or if it is curling up slightly it might jam.
- If your original is larger than the maximum scanning area, do one of the following.
 - Change the user parameters
 - Specify Irregular Scan Area.If the original is jams, press the Clear/Stop key then remove the original carefully.
- When setting originals longer than A3 (420mm)/DLT (17"), use the "Irregular paper size" setting. If you handle long originals frequently, you can specify that the machine accepts originals longer than A3 (420mm)/DLT (17") from the ADF automatically. If you choose this setting and there is a paper jam while scanning, the originals will still be sent. However, there is a possibility that the original will be damaged. For more details refer to "Irregular Scan Area" on page 160 and User Parameters on page 203.
- If your message is bent or folded, flatten it before you set it.
- Set thin originals on the exposure glass.

Cross-reference

- For information about the sizes and number of originals that can be placed in the ADF/ARDF, "ACCECTABLE TYPE OF ORIGINALS" on page 21.

- 1** Adjust the original guide to match the size of your original. Align the edge of your originals and stack them in the ADF/ARDF face up.

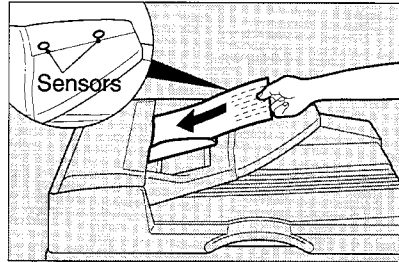

Hint

- If you insert the original too far from the ADF/ARDF, the paper size may not be detected properly.

Sending a Fax Message

Overview

The basic procedure to send a fax message is:

- 1 Make sure the Fax indicator is lit
- 2 Set your original
- 3 Dial the number
- 4 Press **Start**

The rest of this section describes these steps and the various features that are available in more detail.

There are two ways to send a fax message:

- Memory Transmission
- Immediate Transmission

You can check the indicators on the operation panel to check which mode is currently active and press the Transmission Mode key to toggle between them.

MEMORY TRANSMISSION

After you press the **Start** key, the machine scans all pages of your message before it starts dialing. Memory Transmission is useful when you are in a hurry and do not want to spend too long waiting by the machine. It also allows you to send the same message to several destinations (Broadcasting).

IMPORTANT

- ❑ If there is a power failure or the plug is pulled out for more than 1 hour, all the files stored in memory are deleted. If this happens, as soon as you switch back on the Power Failure Report (see page 133) is printed to help you identify deleted files. If you turn just the main switch off, files are not deleted.

Hint

- ❑ Place the original you want to store in memory on the exposure glass or the ADF. To store multiple page originals from the exposure glass, set them page by page.
- ❑ You can scan half the pages of your original from the exposure glass and the remainder from the ADF/ARDF. When you have finished scanning from the exposure glass, place the rest of the pages in the ADF/ARDF and press **Start**.
- ❑ The default transmission mode when the machine is turned on or when modes are cleared is Memory Transmission. You can change this with Initial Setup TX (see page 165).
- ❑ As default, the machine will return to the default transmission mode (Memory) after every transmission. You can change this so that the current mode is maintained with the User Parameters (page 203).

Restrictions

- ❑ If memory is full (0% appears on the display), Memory Transmission is disabled. Use Immediate Transmission instead.
- ❑ The number of pages that can be stored in memory depends on the original images and the scan settings. You can store up to 80 standard pages (ITU-T No. 1 chart, Resolution: Standard, photo mode: OFF).
- ❑ Maximum number of Memory Transmission files : 200
Maximum number of destinations per Memory Transmission : 200
Combined total number of destinations that can be stored : 500

1 Make sure that the Memory Transmission indicator is lit.

- If it isn't, press the **Transmission Mode** key.

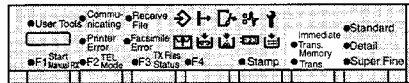

2 Set the original.

Hint

- The original can be placed at any time up until you press the **Start** key.
- You can send the first part of an original from the exposure glass then the second part from the ADF/ARDF. After you place the last page on the exposure glass, you have 60 seconds to insert the remainder of the original in the ADF/ARDF. Note that you cannot set pages on the exposure glass after you have started using the ADF/ARDF.

Cross-reference

"How to Set an Original" ⇒ See page 21.

3 Select the scanning conditions (resolution, density and original type, see page 39).

4 Dial. If you wish to send the same message to more than one destination, press [Add] and dial another destination. Repeat this step for all destinations.

- If you make a mistake, press the **Clear** key and re-enter the correct number.

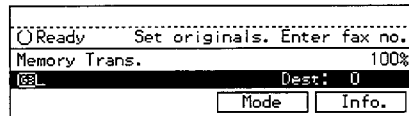

Hint

- When dialing with the number keys or using Chain Dial (page 49), you can select the G3 or G4 before pressing [Add] in step 4.

Cross-reference

“Dialing” ⇒ See page 45.

“Facsimile User Tools” ⇒ See page 135.

5

Press the **Start** key.

- The machine starts scanning the original.
- The machine calls the destination. While it is dialing, the number that you dialed is shown on the display.

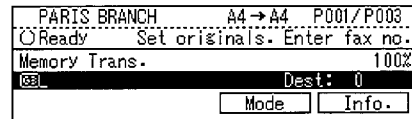
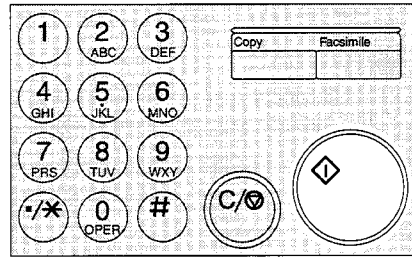

Cross-reference

“see Registering the RTI/CSI” ⇒ See page 193.

- After transmission the machine will return to standby mode.

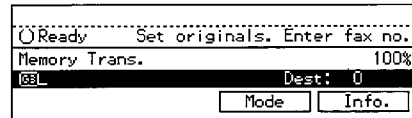

◆Canceling a Memory Transmission

- To cancel a Memory Transmission before it is sent (before pressing the **Start** key), press the **Clear Modes/Energy Saver** key.
- To cancel a Memory Transmission while the original is being stored in memory (after pressing the **Start** key), press the **Clear/Stop** key. The machine stops storing the original. All the scanned data is canceled and not sent.
- To cancel a Memory Transmission after it has been stored in memory or while it is being transmitted, see page 110.

Hint

- If you cancel a Memory Transmission after communication starts, some pages may already be sent to the destination.
- If the transmission finishes while you are still trying to cancel it, the message has already been sent and cannot be canceled.

Cross-reference

- For more information, see “Checking and Canceling the File Settings” on page 110.

◆Checking the transmission result

- Turn the Transmission Result Report (Memory Transmission, see page 27) on if you want a report to be printed after every successful transmission. If you leave it off, a report will not be printed after every transmission, but should a transmission fail, a Communication Failure Report will be printed.
- If you turn the Transmission Result Report (Memory Transmission) off, the Error Report will be printed when the communication fails.
- You can also check the transmission result by examining the TCR (Transaction Confirmation Report, page 123). You can either print it or scroll through it on the display. ⇒ See “Displaying the Transmission Result” on page 117.

◆Sending a fax message immediately

To send a fax message immediately, use Immediate Transmission.

If you have just set up a original for broadcasting, the immediate transmission file will interrupt the current communication.

If there are files queued in addition to the file being currently sent, your original is not be sent until the queued files have been sent.

◆ Automatic Redial

If a fax message could not be transmitted because the line was busy or an error occurred during transmission, redialing is done 4 times at 5 minutes intervals (these figures vary according to which country you are in). If redialing fails after four redials, the machine cancels the transmission and prints the Transmission Result Report (see page 33) or the Communication Failure Report (see page 33).

◆ Broadcasting Sequence

If you dial several destinations for the same message (Broadcasting) the messages are sent in the order in which they were dialed. If the fax message could not be transmitted, the machine Redials that destination after the last destination specified for Broadcasting. For example, if you specify four destinations A through D for broadcasting, and if the lines to the destinations A and C are busy, the machine dials the destinations in the following order: A, B, C, D, A, and C.

◆ Broadcasting: checking the progress

To check up to which destination the fax message has been sent during Broadcasting, print the TX file list (see page 111).

◆ If memory runs out while storing an original

If you run out of memory while storing an original (free space reaches 0%), If you wish to send only scanned page, "Memory full" is displayed. Press [OK] to return to the previous display.

Hint

- By default, successfully scanned pages are sent. If you wish to change this setting, please contact your service representative.

◆ Batch Transmission

If you send a fax message by Memory Transmission and there is another fax message waiting in memory to be sent to the same destination, that message is sent along with your original. Several fax messages can be sent with a single call eliminating the need for several separate calls. This helps save communication costs and reduce transmission time. Fax messages for which the transmission time has been set in advance are sent by batch transmission when that time is reached.

Hint

- By default Batch Transmission is switched on. You can switch it on or off with the User Parameters (page 203).

◆ECM (Error Correction Mode)

This feature automatically resends data that wasn't transmitted successfully using a system that complies with international standards. ECM requires that the destination machine has the same feature.

Hint

- By default ECM is on. You can change this with the User Parameters (see page 203).

◆Parallel Memory Transmission

This function dials while the original is being scanned. Standard Memory Transmission stores the original in memory, then dials the destination. Parallel Memory Transmission allows you to quickly determine whether a connection was made. In addition, this function scans the original faster than Immediate Transmission and is useful when you need to use the original for another purpose in a hurry.

Hint

- By default this feature is turned on. You can change this with the User Parameters (see page 203).

Restriction

- Standard Memory Transmission is used instead of Pararel Memory Transmission when:
 - The line is not connected due to a busy line
 - Send Later is used
 - Transfer Request is used
 - 2-Sided Transmission is used
 - You store an original for Memory Transmission while another communication is in progress
 - Two or more destinations are specified
 - Only an Auto Document is sent
 - When the original is set on the ADF/ARDF
- If the **Clear/Stop** key is pressed, the original jams, or memory becomes full during Pararel Memory Transmission, the machine stops the transmission then prints the Transmission Result Report (Memory Transmission) and erases the file.
- Pararel Memory Transmission print page numbers. For example, P1, P2.

Hint

- If you run out of memory, normal Memory Transmission takes place. When and if this happens varies depending on the various options you have installed.

Memory Storage Report

This report is printed after storing an original in memory. It helps you review the contents and the destinations of stored originals. Even if the machine is set up not to print this report, if an original could not be stored this report is printed.

Hint

- This function can be turned on - see page 203.
- You can choose whether to include part of the original image on the report – see page 203. The default setting is on.

Transmission Result Report (Memory Transmission)

This report is printed when a Memory Transmission is completed so you can check the result of the transmission. If two or more destinations are specified, this report is printed after the fax message has been sent to all the destinations. If the machine is set up not to print this report and the fax message could not be successfully transmitted, the Communication Failure Report is printed (see the below title).

Hint

- By default this function is turned on. To turn it off, see page 203.
- You can choose whether to include part of the original image on the report - see page 203. The default setting is on.

Communication Failure Report

This report is only printed if the Transmission Result Report is turned off and a message could not be successfully transmitted with Memory Transmission. Use it to keep a record of failed transmissions so you can resend them.

Hint

- You can choose whether to include part of the original image on the report - see page 203. The default setting is off.

IMMEDIATE TRANSMISSION

After you press the **Start** key, the number is dialed straight away. Each page is transmitted as soon as it has been scanned. The next page is not scanned in while the current page is being transmitted.

Immediate Transmission is useful if you want immediate confirmation that the message is being sent to the correct destination (just check the other terminal's RTI or CSI during transmission).

Hint

- The original is not stored in memory. Only one destination can be dialed.
- Place the original on the exposure glass or in the ADF. To send two or more pages from the exposure glass, set them page by page.
- You can scan half the pages of your original from the exposure glass and the remainder from the ADF. When you have finished scanning from the exposure glass, place the remainder of the pages in the ADF and press **Start**.
- The default transmission mode when the machine is turned on or when modes are cleared is Memory Transmission. You can change this with the User Parameters (see page 203).
- As default, the machine will return to the default transmission mode (Memory) after every transmission. You can change this with the User Parameters so the current mode is maintained.

1 Check that the Immediate Transmission indicator is lit.

- If it is not lit, press the **Transmission mode** key.

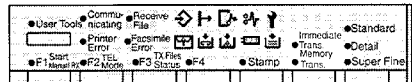

2 Set your original.

Hint

- You can set the original any time up until you press the **Start** key.

Cross-reference

"How to Set an Original" ⇒ See page 21.

3 Select any scan settings you require (see page 39).

4

Dial.

- ❑ If you make a mistake, press the **Clear** key and re-enter the correct number.

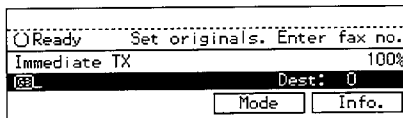

Hint

- ❑ If you are dialing with the number keys or by Chain Dial (see page 49), you can select G3 or G4 (communication mode).

Cross-reference

"Dialing" ⇒ See page 45.

"Selecting a Line" ⇒ See page 197.

5

Press the **Start** key.

- ❑ The machine starts scanning the original.

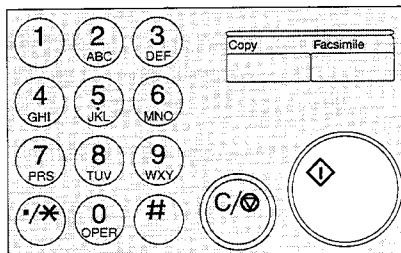

- ❑ The machine calls the destination. While it is dialing, the number that you dialed is shown on the display.

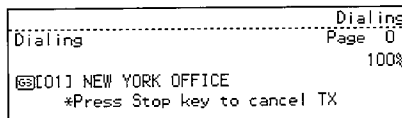

Cross-reference

see "Registering the RTI/CSI" ⇒ See page 193.

- ❑ After transmission the machine will return to standby mode.

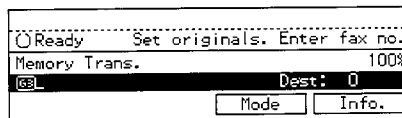

◆Canceling an Immediate Transmission

- If you haven't pressed the **Start** key yet, press the **Clear Modes/Energy Saver** key. If you have set the original, removing it will also cancel Immediate Transmission.
- If you have pressed the **Start** key and the machine is dialing or transmitting, press the **Clear/Stop** key and remove the original. Some pages may have already been sent.

◆If the destination could not be connected to

If it was not possible to make a connection with the number you dialed (for example if the line was busy or there is a line problem), the display opposite appears:

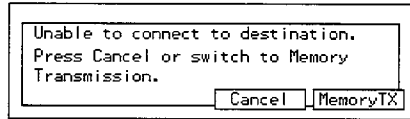

- If you press [Memory Trans.], the machine will scan all the originals into memory. When finished, it will begin redialing the destination and, if possible, send the message from memory.
- If you press [Cancel] then [OK] the transmission will be canceled.

◆ECM (Error Correction Mode)

This feature automatically resends data that wasn't transmitted successfully using a system that complies with international standards. ECM requires that the destination machine has the same feature.

Hint

- By default, ECM is on. You can change this with ECM (see page 174).

Transmission Result Report (Immediate Transmission)

If you turn this report on, a report will be printed after every Immediate Transmission so you have a record of whether the transmission was successful or not. If the machine is set up not to print this report and the fax message could not be successfully transmitted. The Error report is printed.

Hint

- By default this report is turned on. Switch it off with the User Parameters (see page 203).

On-hook Dial (not available in some countries)

This is just like using the optional handset, except you do not have to pick up the handset before dialing. Just press the On Hook Dial key and dial the number. If you hear a voice, you can pick up the handset and speak with the other party.

Restriction

- The machine cannot dial on ISDN lines.

1

Place the original and select any scan settings you require.

Cross-reference

"How to Place an Original" ⇒ See page 21.

"Selecting the Scan Settings (Resolution, Density and Original Type)" ⇒ See page 39.

2

Press the **On Hook Dial** key.

- You will hear a low tone from the internal speaker. If you wish to cancel this operation, press the **On Hook Dial** key again.

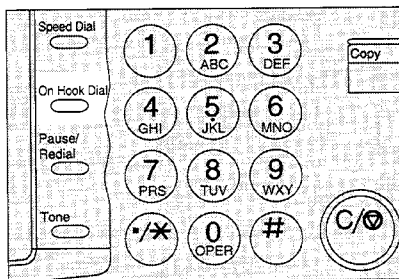

3

Dial.

- The machine immediately dials the destination. If you make a mistake, press the **On hook dial** or **Clear/Modes** key and return to step 2.

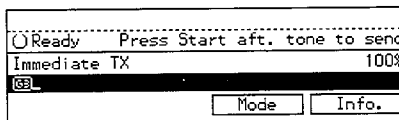

4

When the line is connected and you hear a high-pitched tone, press the **Start** key.

- If you hear a voice, pick up the handset before you press the **Start** key and notify the destination that you want to send a fax message (ask them to switch to Fax mode).

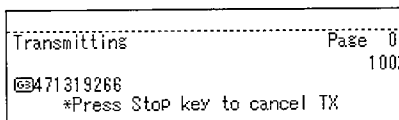

- After transmission the machine will return to standby mode.

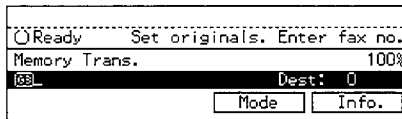

Manual Dial (handset option required)

Pick up the handset or an externally connected telephone handset and dial. When the line is connected and you hear a high-pitched tone, press the **Start** key to send your fax message. If, on the other hand, you hear a voice at the other end, continue your conversation as you would normally over the telephone.

Restriction

- The machine can not dial on ISDN lines.

1 Place the original and select any scan settings you require (see page 22).

2 Pick up the handset.
 You will hear a tone from the external handset.

3 Dial.
 If you make a mistake, replace the handset and try again from step 2.

4 When the line is connected and you hear a high-pitched tone, press the **Start** key.
 The machine starts sending the fax message. If you hear a voice, pick up the handset before you press the **Start** key and notify the destination that you want to send a fax message (ask them to switch to Fax mode).

5 Replace the handset.
 After transmission the machine will return to standby mode.

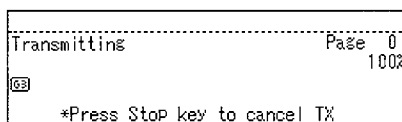
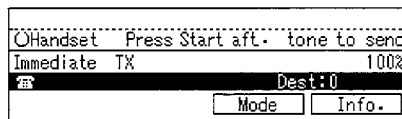

You may wish to send many different types of fax message. Some of these may be difficult to reproduce at the other end. However, your machine has three settings that you can adjust to help you transmit your document with the best possible image quality.

◆ **Resolution:**

Standard, Detail, Super Fine (option)

◆ **Image density:**

Auto Image Density, Manual Image Density (7 levels)

◆ **Original type:**

Text, Photo/Text, Photo

Resolution

Images and text are scanned into the machine by converting them to sequences of dots. The frequency of dots determines the quality of the image and how long it takes to transmit. Therefore, images scanned at high resolution (Super Fine) have high quality but transmission takes longer. Conversely, low resolution (Standard) scanning results in less quality but your original is sent more quickly. Choose the setting that matches your needs based upon this trade off between speed and image clarity.

Restriction

- If the receiver's machine does not support the resolution at which you are sending, the machine automatically switches to a resolution which is supported.
Sending with Super Fine resolution requires that your machine has the High Resolution Card option, and the destination has capability to receive fax message at Super Fine resolution.

Hint

- When the machine is turned on or modes are cleared, the resolution is set to Standard by default. You can change this with the User Parameters (see page 203).
- By default, the resolution returns to the default after every transmission. You change this with the User Parameters (see page 203) so that the current resolution is maintained.

◆ **Standard (8 × 3.85 lines/mm, 200 × 100dpi)**

Select for originals containing normal sized characters (e.g. handwriting or typewriter7).

◆ **Detail (8 × 7.7 lines/mm, 200 × 200dpi)**

Select for originals containing small characters or when you require greater clarity. This resolution is twice as fine as Standard.

◆ Super Fine (16 × 15.4 lines/mm, 400 × 400dpi)

The High Resolution Card option is required for this mode.

Select for originals with very fine details or when you require the best possible image clarity. This resolution is eight times as fine as Standard.

1

Press the Resolution key to switch between resolutions. The indicators above show the current selection.

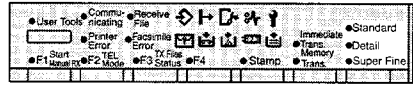

Original Type

If your original contains photographs, illustrations or diagrams with complex shading patterns or grays, select the appropriate Original Type to optimize image clarity.

Restriction

- If you select Photo/Text or Photo, the Resolution is automatically set to Detail. Even if you select Standard again, the image density will not return to Standard.
- If you select Photo or Photo/Text, you cannot select Auto Image Density.

Hint

- If you select Photo/Text or Photo, the transmission will take longer than when Text is selected.
- If you send a fax message with Photo/Text or Photo, the background of the received image may be marked. If this happens, lower the density and re-send the fax.
- When the machine is turned on or modes are cleared, Original Type is set to Text. You can change this with the User Parameters (see page 203).
- As default, the machine returns to the default Original Type after every transmission. You can change this with the User Parameters so that the current Original Type is maintained.

◆ Text (Default Setting)

Text is selected when the Photo and Photo/Text indicators are NOT lit.

Select Text to send an original containing a high-contrast black-and-white image such as text. Use this setting even if your original contains text and photographs if you only want to send clearer text.

◆ Photo/Text

Photo/Text is selected when the UPPER Original Indicator (☐) is lit.

Select Photo/text to send an original containing both a high-contrast black-and-white image, such as text, and a halftone image such as a photograph.

◆Photo

Photo is selected when the LOWER Original indicator (📷) is lit.

Select Photo to send an original containing a halftone image such as a photograph or a color original.

- 1 Press the **Original Type** (📷) key until the indicator matching the type you require is lit.

- When both indicators are not lit, the Original Type is Text.

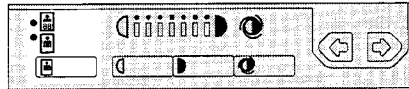

Image Density (Contrast)

The text and diagrams in your original must stand out clearly from the paper they are written on. If your original has a darker background than normal (for example, a newspaper clipping), or if the writing is faint, adjust the image density.

By default, this machine will automatically select a density setting appropriate to the original (Auto Image Density). However, should you wish to change the density yourself, use Manual Image Density.

◆Auto Image Density

The machine automatically selects an image density which is the most appropriate for the original.

- By default, Auto Image Density is selected when the machine is turned on or modes are cleared. You can change this with the User Parameters (see page 203).

- 1 If the Auto Image Density indicator is not lit, press the (🔍) key to turn it on.

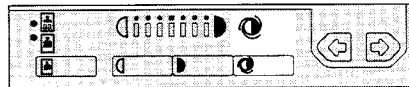

◆Manual Image Density

Use the Image Density keys to increase or decrease the image density within 7 levels.

- 1 Press the (◀) or (▶) key to change the density. The indicators above the keys show the level.

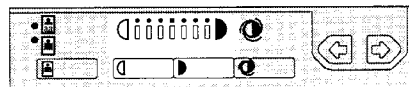

Mixing Scan Settings in a Multiple Page Original

When sending an original consisting of several pages, you can select different Image Density, Resolution and Original Types for each page.

Set your original, select the scan settings for the first page, dial and press **Start** as you would normally. Then follow one of the following two procedures.

When the original is placed on the exposure glass

Restriction

- ❑ Select density, resolution and original type while the machine is bleeping (for about 60 seconds in Memory Transmission, 15 seconds in Immediate Transmission). The remaining time is shown on the display.

1 Remove the previous page and place the next page.

2 Select the Image Density, Resolution and Original type.

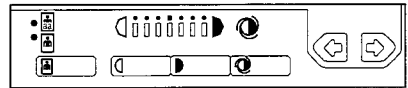
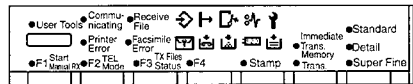

When the original is placed in the ADF

1 Select the Image Density, Resolution and Original Type before the next page is scanned.

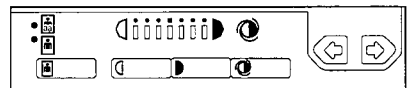
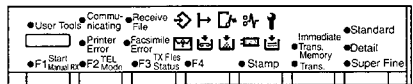

CHANGING LINE TYPE (OPTIONAL ISDN UNIT REQUIRED)

This machine comes with a single Analog (PSTN) line connection for G3 communication as standard. If you install the ISDN Unit option, an extra Digital (ISDN) line connection for either G3 or G4 communication becomes available.

F4 key is for communication type selections as default.

Press the F4 key to toggle between G3 and G4.

When the F4 key is lit, G4 is selected.

Restriction

- When transmitting, you can only select the line type if dialing with the number keys or Chain Dial.
- Either PSTN or ISDN for G3 communication are selected by the service representative.

◆ Switching to G3

If the F4 is lit, press it once to switch to G3.

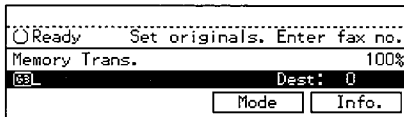

◆ Switching to G4

If the F4 is not lit, press it once to switch to G4.

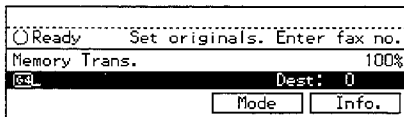
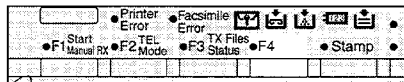

◆Which line is used for G3 transmissions?

- ISDN lines can be used for G3 communication as well as G4 communications, so this machine is set by default to use the ISDN line for both G3 and G4 transmissions. If you wish to use the Analog (PSTN) line for G3 transmissions, contact your service representative.
- When G3 is used over the ISDN, the subaddress can be.

◆Auto Identification (Optional ISDN Unit is Required)

This feature works when G4 is selected. The machine first tries a G4 communication, and if it cannot connect because the receiver is not a G4 terminal, it automatically switches to G3 and redials.

- If the G3 line at the destination is connected to the ISDN via a TA (Terminal adapter) or a PBX, since the called number is on ISDN, the G3 line is regarded as G4 and the Auto Identification feature may not automatically switch this machine to G3.

Overview

There are three main ways to dial a number:

- Number keys: Enter the number directly
- Quick Dial: Dial a stored number with a single key press
- Speed Dial: Dial a stored number by entering a 2-digit or 3-digit (Optional Function Upgrade card required) code

This section covers these features and others in more detail.

Number Keys

Enter numbers directly using the key pad on the right side of the operation panel.

Hint

- Pauses (see page 47) and a tone key (see page 47) can be inserted in a fax number.
- If the ISDN unit is installed, you can enter the subaddress (see page 48).

1 Place an original and select any scan settings you require (see page 39).

2 Enter the fax number with the number keys.

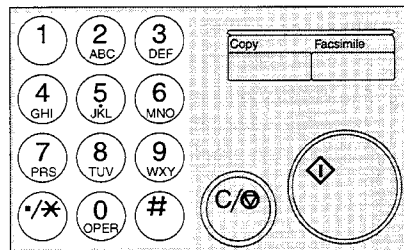

- The digits appear on the display.

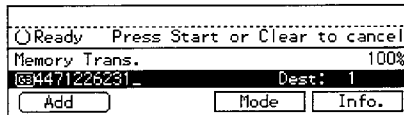

Hint

- If you make a mistake, press the **Clear/Stop** key to erase each digit and try again.
- If you wish to dial another destination, press [Add], then enter the next destination.
- If the optional ISDN unit is installed, select G3 or G4 before pressing the **Start** key.

3 Press the **Start** key.

◆ Restrictions when dialing with the number keys

- Maximum length of a fax number: 254 digits.
- Fax numbers entered with the number keys are stored in internal memory (separate from memory for storing original data). Excluding Speed Dials and Quick Dials, Dials by the ten keypad the combined total of the following three types of destinations cannot exceed 99:
 - Destinations specified in a Memory Transmission (including Confidential Transmission and Polling Reception)
 - Transfer Stations and End Receivers specified in a Transfer Request
 - Destinations and Transfer Stations specified in a Group
- For example, when 90 destinations are registered in a Group with the number keys, only 9 destinations can be dialed for Memory Transmission from the number keys.
- When this machine is requested to transfer a call (this machine becomes a Transfer Station), 2 fax numbers are automatically stored. Therefore, the number of destinations that can be dialed from the number keys decreases by two whenever this machine is requested to transfer a call.
- When a total of 99 fax numbers is stored, only Immediate Transmission is allowed.
- If a Group is defined when there are files queued for transmission, the message "Memory is full and you cannot enter with number keys" may be shown on the display and no additional fax numbers can be stored even if the number of destinations specified from the number keys is less than 99. That is because the fax numbers have been dialed from the number keys for some of the waiting files. When the waiting files have been sent and their fax numbers are deleted from memory, additional fax numbers can be dialed.
- The display shows the percentage of free space in memory for storing originals. Since fax numbers are stored in separate memory, dialing fax numbers from the number keys does not change the percentage on the display.

Pause

Press the Pause/Redial key when dialing or storing a number to insert about a two-second pause.

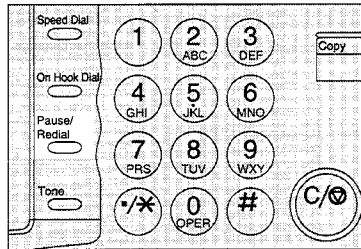

Restriction

- A pause cannot be inserted before the first digit of a fax number.

Hint

- A pause is shown as a “-” on the display.
- You can insert a pause in numbers stored in Quick Dials and Speed Dials.

Tone

This feature allows a machine connected to a pulse dialing line to send tonal signals (for example if you want to use a special service on a tone dialing line). When you press the **Tone** key, the machine dials the number using tonal signals.

Restriction

- A tone cannot be placed before the first digit of a fax number.
- Some services are not available even by sending tonal signals with the Tone key.

Hint

- A tone is shown as a “•” on the display.

◆ Sending tonal signals to ISDN (ISDN option required)

Even if this machine is only connected to an ISDN line, it can send tonal signals to the ISDN line.

- This feature can only be used for Memory or Immediate Transmission. The machine cannot dial ISDN using On hook dial or Manual Dial.

Subaddress (ISDN option required)

ISDN allows two or more terminals (such as a facsimile and digital telephone) to be connected to a single line. These terminals are identified by their subaddress numbers. If the terminals connected to the line at a destination are assigned subaddresses, dialing a subaddress allows you to direct your fax message to a particular terminal at the destination.

Restriction

- The subaddress can only be used with ISDN.

Hint

- The subaddress function must be programmed in a User Function key. ⇒ See “Assigning User Function keys” on page 167.
- A subaddress number can be programmed in a Quick Dial or Speed Dial.
If you want to assign a subaddress to your fax machine, contact the service representative.

1

Place an original and select any scan settings you require.

2

Select either G4 or G3(ISDN).

3

Dial the fax number with the number keys.

4

Press the User Function key (F1 through F3) where the subaddress function has been registered.

- “ / ” is displayed.

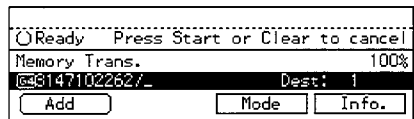
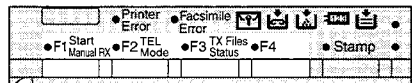

5 Enter the destination subaddress with the number keys.

6 Press the **Start** key.

Chain Dial

This allows you to compose a telephone number from various parts, some of which may be stored in Quick Dials or Speed Dials and some of which may be input using the number keys.

Restriction

- Maximum length of telephone or fax number: 254 digit

Hint

- For Memory Transmission and Immediate Transmission, insert a pause between numbers. For On hook dial and Manual Dial, no pause is needed.

◆(Example) 01133-1-555333

Assume that 01133 is registered to Quick Dial 01 and that 1 is registered to Speed Dial 01.

- 1 Place the original and select any scan settings you require.
- 2 Press **Quick Dial key 01**.
- 3 Press the **Pause/Redial** key.
- 4 Press the **Speed Dial** key and **0** and **1** using the number keys.
- 5 Press **5, 5, 5, 3, 3** and **3** using the number keys.
- 6 Press the **Start** key.

Quick Dial

When you have stored a destination's number in a Quick Dial key, you can dial the number by just pressing that key.

Additionally, you can store a name that will appear on the display whenever you press the Quick Dial.

Cross-reference

"Dialing" ⇒ See page 45.

Hint

- Flip the operation panel cover over to access copy function or Quick Dial keys.
- Flip the Quick Dial plate over to access Quick Dial keys 01-28 or 29-56.
- If you require, the name you have programmed for this number can be printed on the first received page.
⇒ See "Label Insertion" on page 105.

1

Place an original and select any scan settings you require (see page 39).

2

Press the Quick Dial key in which the destination's number is programmed.

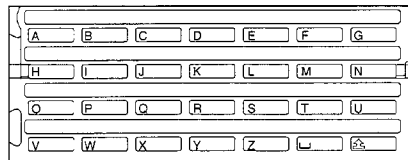

- If the destination's name has been stored, the name is shown on the display. Otherwise, the fax number is shown.

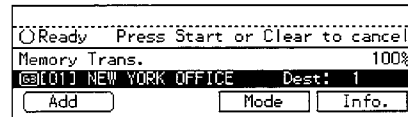

Hint

- If you make a mistake, press the **Clear/Stop** key and try again.
- If you wish to dial another destination, press [Add] and dial another fax number.

3

Press the **Start** key.

Speed Dial

If you store a number in a Speed Dial, when you want to dial it just press the Speed Dial key followed by a 2 or 3 digit code. For more information on storing numbers see page 149.

Hint

- ❑ Codes from 00 to 99 can be specified. If the Function Upgrade Card option is installed, codes from 000 to 999 can be specified.
- ❑ If a search letter is registered with a Speed Dial code, it can be searched for using Telephone Directory (see page 52).
- ❑ If you have programmed a name for the Speed Dial, it can be printed on the first received page. See "Label Insertion" on page 105.

1 Place an original and select any scan settings you require (see page 39).

2 Press the **Speed Dial** key.

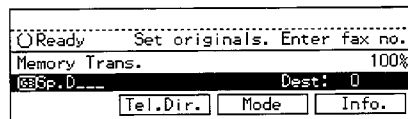
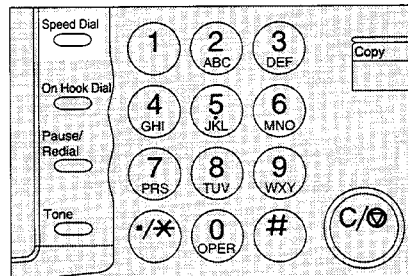

3 Enter the two-digit code (00 to 99) or three-digit code (000 to 999) for the destination with the number keys.

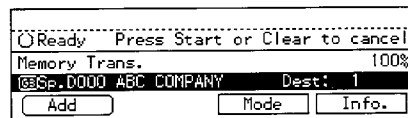

- ❑ If the destination's name has been programmed the name is shown on the display. Otherwise, the fax number is shown on the display.

Hint

- If you make a mistake, press the **Clear/Stop** key and try again.
- If you wish to dial another destination, press [Add] and dial another fax number.

4

Press the **Start** key.

Telephone directory

This feature lets you find a stored Speed Dial quickly by just entering a single letter, e.g. the first letter of the name stored for that number.

Restrictions

- Speed Dial codes cannot be searched for by symbol or number.
- Names enclosed within () are not searched for.

Before operation

- When programming a Speed Dial, register a search letter. ⇒ See “Programming a Speed Dial” on page 149.

1

Place an original and select any scan settings you require.

2

Press the **Speed Dial** key.

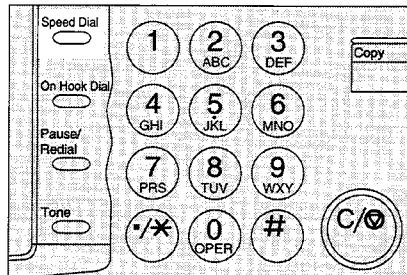

3 Press [Tel. Dir.].

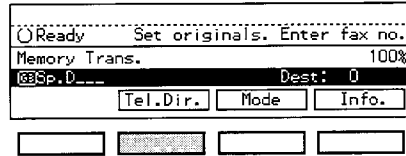

4 Press the Quick Dial key corresponding to the search letter (A to Z).

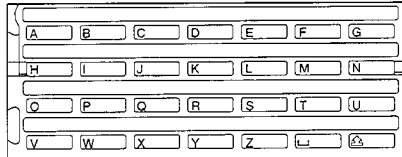

- The names or fax numbers registered in Speed Dials are shown in numerical order on the display.

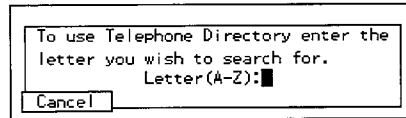

5 Enter the two-digit code (00 to 99) or three-digit code (000 to 999) for the destination with the number keys.

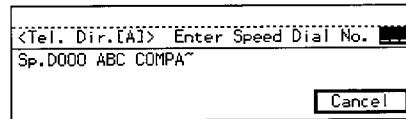

Hint

- If the list does not contain the desired destination, press [Prev.] or [Next].
- If you make a mistake, press the **Clear/Stop** key to try again.
- If you wish to dial another destination, press [Add] and dial another fax number.

6 Press the **Start** key.

Groups

If you frequently send the same message to more than one place, program these numbers into a Group. Then you can send the messages to all the destinations in that Group with just a few keystrokes. You can also program a name for the Group (for example “Branch Offices”) which will be displayed before you press the **Start** key.

Cross-reference

“Programming a Group” ⇒ See page 141.

Hint

- ❑ Up to 9 groups can be programmed.
- ❑ Up to 200 destinations can be included in a Group. If a Quick Dial or Speed Dial is registered in two Groups, it takes up the space of one destinations.
- ❑ A Transfer Station can also be included in a Group. However, a Group containing a Transfer Station cannot be used for normal transmission. ⇒ See “Multistep Transfer Group” on page 175.

Restrictions

- ❑ A Quick Dial included in a Group cannot be used for other functions.
- ❑ Group Dial can be used only for Memory Transmission; it cannot be used for Immediate Transmission.

Before operation

- ❑ Make sure that the Immediate Trans. indicator is off. If it is on, press the **Memory Trans.** key to turn it off.

1 Place an original and select any scan settings you require.

2 Press the Quick Dial key in which the Group is programmed.

- ❑ The Group number is shown on the display. If the Group name is programmed, the name is also shown on the display.

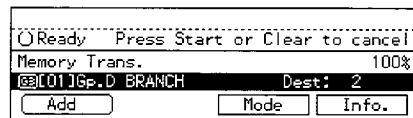
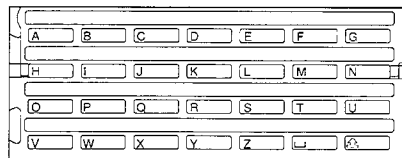

Hint

- ❑ If you make a mistake, press the **Clear/Stop** key and start again.
- ❑ If you wish to dial another destination, press [Add] and dial another fax number.

3

Press the **Start** key.

Optional Group Dial (Function Upgrade Card Required)

If the Optional Group Dial function is registered to a User Function key, just press the User Function key and enter the Optional Group number (10-30) to dial.

Optional Groups can be used to specify several destinations at a time. Up to 9 Groups can be registered, and up to 21 Optional Groups can be registered.

Cross-reference

“Registering an Optional Group” ⇒ See page 145.

Hint

- ❑ Up to 200 destinations can be included in a Group. If a Quick Dial or Speed Dial is registered in two Groups, it takes up the space of one destinations.
- ❑ A Transfer Station can also be included in a Group. However, a Group containing a Transfer Station cannot be used for normal transmission. ⇒ See “Multistep Transfer” on page 175.

Restrictions

- ❑ Optional Group Dial can be used only for Memory Transmission; it cannot be used for Immediate Transmission.

Before operation

- ❑ To use this function, you need to have registered the Optional Group Dial function in a User Function key. ⇒ See “Assigning User Function Keys” on page 167.

1 Place an original and select any scan settings you require.

2 Press the user function key (F1 through F4) in which the optional Group Dial function is registered.

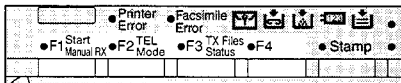

3 Enter an Optional Group number with the number keys.

- ❑ The Optional Group number is shown on the display. If the Group name is registered, the name is also shown on the display.

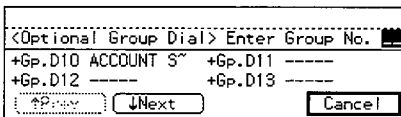

Hint

- ❑ If you make a mistake, press the **Clear/Stop** key to specify again.
- ❑ If you dial more destinations, press [Add] to dial other fax numbers.

4 Press the **Start** key.

Redial

The machine memorizes the last 10 destinations that have been dialed.

1 Press the **Pause/Redial** key.

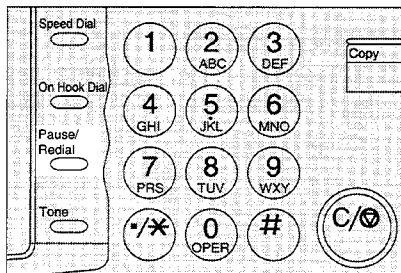

2

A list of previously dialed numbers will flash up. If you cannot see the number you need use the [**↑**Prev] and [**↓**Next] keys to scroll through them. Then enter the code for the number you wish to redial, e.g. "01".

<Redial> Enter no. of destination	
01 471312262	02 471316626
03 226231471	04 7645
[<Prev]	[>Next] [Cancel]

Restrictions

- The following kinds of destinations are not memorized:
 - Quick dial
 - Speed dial
 - Group dial
 - Destination dialed by a Program
 - Destination dialed as an End Receiver for Transfer Request
 - Destination dialed using the external telephone keypad (option)
 - Destination dialed by Redial (regarded as already memorized)
 - Any destinations after the first number if multiple destinations were dialed.
- Redial will only work if you have not entered any digits of the number already. If you press the **Pause/Redial** key after entering digits, a pause is inserted.

Hint

- If the receiver uses a facsimile of the same manufacturer that is capable of registering the RTI, the name may be shown on the display instead of the fax number.

TRANSMISSION FEATURES

Stamp

When sending a fax message using the ADF, the machine can stamp a circle mark at the bottom of the original. This stamp indicates that the original has been successfully stored in memory for Memory Transmission, or that it has been successfully sent for Immediate Transmission.

Hint

- ❑ When the stamp becomes lighter, replace the cartridge. ⇒ See “Replacing the Stamp Cartridge” on page 220.

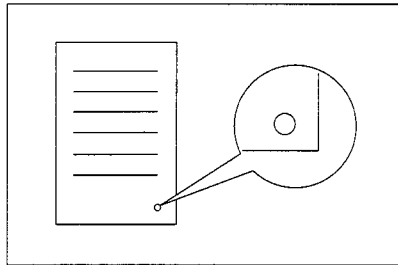

Restriction

- ❑ This machine stamps only when the original is placed in the ADF.

Hint

- ❑ If a page was not stamped even if the stamp feature is on, re-send the page.
- ❑ The User Parameters (see page 203) can be used to switch the stamp feature on or off. This parameter setting can be overridden by pressing the **Stamp** key. The default setting is Off.



Press the **Stamp** key.

- ❑ Each time you press the **Stamp** key, the indicator toggles on and off. When lit, stamp is on.

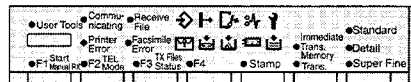

ID Transmission

This feature allows you to restrict transmission of messages only to machines of same make, and only to machines that have the same Polling ID registered. With the transmission options, you can switch ID transmission on and off for each separate transmission.



- The User Parameter (see page 203) can be used to switch ID transmission on or off. The default setting is Off.

Receiving a Fax Message

Receiving a Fax
Message

Overview

Your machine receives fax messages in two ways:

- Immediate Reception
- Memory Reception

Usually, machine automatically chooses the method depending on the situation. However, Memory Reception may be turned off (see "User Parameters" page 203).

IMMEDIATE RECEPTION

Each page of a received fax message is printed as soon as it is received. This method is used for standard fax messages.

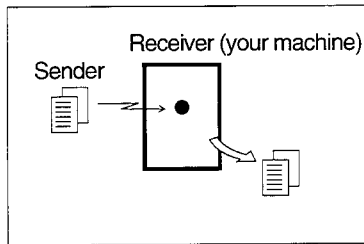

◆Display during Reception

PARIS BRANCH	A4 → A4	P001
○ Ready	Set originals. Enter fax no.	
Memory Trans.		100%
63	Dest: 0	
	Mode	Info

On the first line is the receiver's RTI or CSI.

◆Resolution at Reception

This machine supports Standard and Detail resolutions for reception. If you do not have the High Resolution Card option, faxes sent at Super Fine resolution will be printed on your machine at Standard resolution. This way result in a slightly different image. Reception will not take place if there is not enough free memory left. If free memory reaches 0% during Immediate Reception, any further reception becomes impossible and the current communication is terminated.

MEMORY RECEPTION

The machine waits until all pages of the message have been received into memory before printing the message. This method is used with the following features:

- Two in one (see page 72)
- Multi-copy when set to multiple copies (see page 71)
- Reverse Order Printing (see page 73)
- Substitute Reception (see page 64)
- 2-sided Printing (Optional Duplex Tray And Memory Card or Hard Disk required: see page 71)

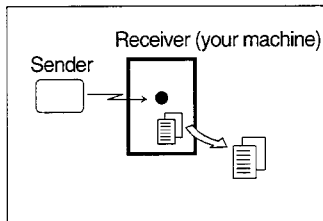

Receiving a Fax
Message

Restriction

- Machine may not receive fax messages when the free memory space is low.

Hint

- If the memory free space reaches 0% during Memory Reception, the machine can no longer receive the current fax message and stops communicating.

IMPORTANT

- All the messages stored in memory are deleted if the power is switched off for more than one hour. However, note that if the Hard Disk option is installed, all stored messages are not deleted.
- If the machine is left with Memory Reception mode switched on, it may not be able to receive large numbers of messages or messages with a lot of information. In such a case, we recommend you to switch Memory Reception mode off or add memory card.

Substitute Reception

If any of the following conditions are met, this machine automatically switches to Memory Reception mode and stores messages in memory instead of printing them. This reception mode, in which a received fax message is stored in memory unprinted, is called Substitute Reception. Messages received in Substitute Reception mode are automatically printed when the condition which caused the machine to start Substitute Reception is rectified. Substitute Reception takes place when:

- Paper runs out
- Toner runs out
- Paper is jammed
- The front or side cover is open
- A fax is received during a copy or print run

Reception will not take place if there is not enough free memory left.

Hint

- When this machine starts Substitute Reception, the Receive File indicator lights.
- User Parameters (see page 203) can be used to switch Substitute Reception on or off. The default setting is on.
- If free memory reaches 0% during Substitute Reception, any further reception becomes impossible and the current communication is terminated.

Screening messages from anonymous senders

To help you screen out unwanted messages that may fill up your memory, the machine can be programmed to only use Substitute Reception for messages that arrive with identification (RTI/CSI).

To settings are available:

- "When RTI or CSI is received"
- "Unconditional"

Hint

- The default setting is "When RTI or CSI is received", i.e. only store messages when the RTI/CSI is present. You can change this with the User Parameters (see page 203).
- Even if the sender does not have an RTI or CSI, the machine will still receive messages using Substitute Reception if:
 - paper becomes jammed while the main switch is on.
 - for some reason printing is not possible e.g. a copy job is in progress.

◆When RTI or CSI is received

The machine switches to Substitute Reception only when the sender has programmed their RTI or CSI. If the power is switched off for more than an hour, all the messages received into memory are deleted. In such a case, the Power Failure Report or the TCR can be used to identify which messages are lost and ask the senders to re-send them.

IMPORTANT

- If the sender has not programmed their RTI or CSI, the machine may reject an important fax message. We recommend you to ask the sender to register an RTI or CSI in advance.

◆Unconditional Substitute Reception

The machine switches to Substitute Reception regardless of whether or not the sender has programmed their RTI or CSI.

SELECTING THE RECEPTION MODE

There are two ways you can set up your machine to handle incoming calls:

- Fax mode
- Telephone mode (handset option or external telephone required)

The default setting is Fax mode. You can change to Telephone mode with the User Tools (see page 135).

Fax Mode (Auto Reception Mode)

When a telephone call comes in, the machine receives it automatically as a fax message. Use this setting for a dedicated fax line.

Telephone Mode

When a call comes in you have to pick up the handset or external telephone and decide whether the call is a fax message yourself. If you hear a voice, continue your conversation as you would with a normal telephone. If you hear high pitched beeps, instruct the machine to receive the fax by following the procedure below.

Use this setting if you wish to share the line between the fax machine and a telephone.

◆Receiving a Fax in Telephone Mode

A User Function key must be programmed beforehand as the Start Manual RX key (see page 167).

The default setting is F1 key.

- 1 When the machine rings, pick up the handset.
- 2 If you hear beeps, press the User Function key (F1) which has been programmed as the Receive Mode key.
- 3 Replace the handset. The machine will start receiving.

◆Changing Fax Mode to Telephone Mode

A User Function key must be programmed beforehand as the TEL Mode key. The default setting is F2 key.

If you wish to change the reception mode, press the User Function key (F2) which has been programmed as Reception Mode key.

Transfer Station

Transfer Stations allow you to expand the standard features of your fax machine to set up complex networks. The Transfer station must be machines of the same make. The following terminology is used in this section.

◆ Requesting Party

The machine where the message originates from, i.e. the machine making a Transfer Request.

◆ Transfer Station

The machine that forwards the incoming message to another destination, i.e. the machine that receives the Transfer Request. In this section this refers to your machine.

◆ End Receiver

The final destination of the message, i.e. the machine that the Transfer Station sends to. End Receivers must be programmed into Quick Dials, Speed Dials or Groups in the Transfer Station (this machine).

The diagram below may make the concept clearer.

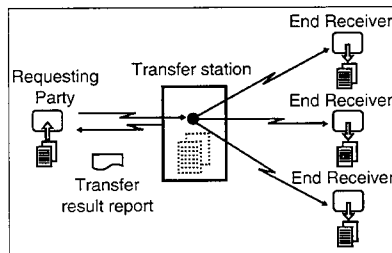

◆ Cross-reference

“Transfer Request” ⇒ See page 101.

◆ Restrictions

- Polling ID's of the Requesting Party and Transfer Station must be identical for this feature to work.
- This machine will not receive a Transfer Tequest unless it has enough free memory to store two or more destinations dialed from the number keys.
- If the Requesting Party specifies a Group for the End Receivers and the total number of End Receivers exceeds 200, the Transfer Station cannot transfer the message and sends a Transfer Result Report to the Requesting Party.

◆Multi-step Transfer (Memory Card or Hard Disk option required)

The principles of Transfer Stations can be used to build up a multi-step facsimile network where messages are passed through several Transfer Stations. By programming the end receivers in a Transfer Station Group, you can enable this machine to transfer messages onto other transfer stations.

For more information, contact your service representative.

This feature can only be used if the machines are made by the same maker.

Cross-reference

See "Multistep Transfer Group" ⇒ See page 175.

◆Sending the Transfer Result Report

This machine compares the own fax number of the Requesting Party with the Requesting Party's number programmed in a Quick Dial or Speed Dial, and if the lower five digits of the two numbers match, it sends the Transfer Result report to the Requesting Party.

(Example)

Requesting Party's own dial number: 001813-11112222

Transfer Station's Quick Dial: 03-11112222

Transfer Result Report

This reports whether transmission to the End Receivers was successful or not. When the Transfer Station has transferred the message to all End Receivers, it sends the Transfer Result Report back to the Requesting Party. The machine prints the report if it cannot be sent back to the Requesting Party. You must program the fax number of the requesting party in a Quick Dial (see page 138) or Speed Dial (see page 149) in the Transfer Station.

Before operation

- Register the own fax number in advance. ⇒ See "G3 Analog Line setting" on page 197.

Hint

- By default, a portion of the original image is printed on this report. You can turn this off with the User Parameters (see page 203).

ID Reception

If you wish to limit reception of messages to those from machines of the same make and with the same Polling ID, contact your service representative to turn this feature on.

Print Completion Beep

By default, this machine beeps to let you know when a received message has been printed.

Hint

- You can alter the volume of the beep or turn it off completely (set the volume to 0). See "Volume Control" on page 192.

Checked Mark

By default, a checkered mark is printed on the first page of fax messages to help you separate them.

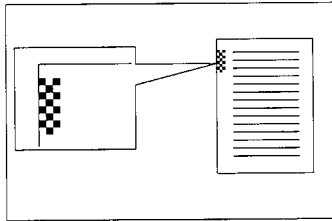

Hint

- This feature can be turned off. See "User Parameters" on page 166 and 203.

Center Mark

This machine can mark printed halfway the left side and at the top center of each page received. This makes it easy for you to position the hole puncher correctly when you file received messages.

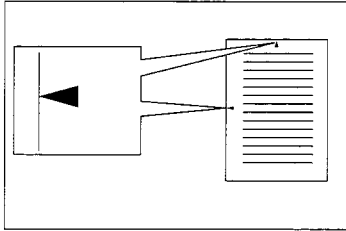

Restrictions

- The center mark may deviate a little from the exact center of the edge.

Hint

- This feature can be turned on. See "User Parameters" on page 166 and 203.

Reception Time

The date and time of reception can be printed at the bottom of the received message. This is turned on by default. To turn it on, see "User Parameters" on page 166 and 203.

Restriction

- When a received message is printed on two or more sheets, the date and time is printed on the last page.

Hint

- The date and time when the message was printed can also be recorded on the message. If you need this feature, please contact your service representative.

Multi-copy Reception (Memory Card Or Hard Disk Option Required)

If you switch this feature on, more than one copy of each incoming fax message can be printed. You can also choose to have multiple copies made of messages from particular senders (see page 166 and 183).

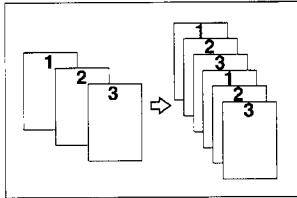

Restrictions

- The maximum number of copies that can be made of each message is 10. If you are using Multi-copy with Specified Senders, the maximum number is 9.

Hint

- By default this feature is turned off. To switch it on, see "User Parameters" on page 203. Note that the machine will use Memory Reception for Multi-copy.

2-Sided Printing (Optional Duplex Tray And Memory Card Or Hard Disk Required)

With this option installed, a received message can be printed on both sides of the paper. By default this feature is turned off. To switch it on, see "Initial Setup RX" on page 166 and 183. If you switch this feature on, select length-wise copy paper.

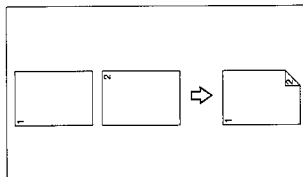

Restrictions

- This feature can work only when all the pages of a received message have the same width and the all the messages can be received into memory.
- Note that the machine will use Memory Reception for 2-Sided Printing.
- This feature cannot be used with Two in One.
- Printouts may vary in their direction/orientation depending on how the sender set them.

Hint

- You can choose to have messages only from selected locations printed in this way. see page 166 and 183.

Image Rotation

If you have installed the paper in the cassette sideways, incoming fax messages will be rotated automatically to fit on the paper.

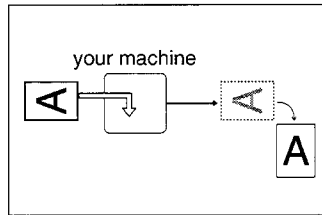

Restrictions

- You can specify received messages to be printed from the Paper feed Tray (see pages 205).

Two In One

When two messages of the same size and direction are received consecutively, they are printed on a single sheet when you turn this feature on. This can help you economize on paper.

- Two A5 messages are printed side by side on a sheet of A4 .
- Two B5 messages are printed side by side on a sheet of B4 .
- Two A4 messages are printed side by side on a sheet of A3 .
- Two 8½ × 5.5" messages are printed side by side on a sheet of 8½ × 11" .

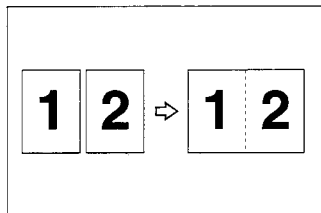

Restrictions

- This feature does not work with messages larger than A5 , B5 , A4 , or LT . When A5 , B5 , A4 or LT size paper is loaded in the machine, each page of the received message is output on a single sheet.

Hint

- By default this feature is turned off. Switch it on with the User Parameters (see page 203). Note that when on, this feature will use Memory Reception.

Page Separation and Length Reduction (not available in some countries)

When the size of a received message is longer than the paper loaded in the machine, each page of the message can be split and printed on several sheets or can be reduced and printed on a single sheet. For example, when LT paper is loaded, this feature splits the received message if the excess length is about 0.79" or more, and reduces it if the excess length is within about 0.79". When a message is split, the split mark (*) is inserted at the split position and about 0.39" split area is duplicated on the top of the second sheet.

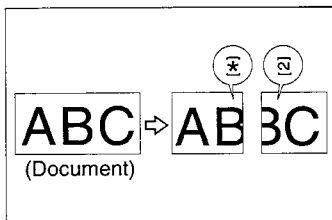

Hint

- Your service representative can customize this feature with the following settings. Bracketed values are defaults.
 - Reduction (ON) •Print split mark (ON)
 - Overprinting (ON) •Overprinting length (0.39")
 - Guideline for split (when message is 0.79" longer than paper)
- The overprinting length may be changed as follows.
 - Guideline for split : 0 ~ 6.1"
 - Overprinting length : 0.16", 0.39", 0.79", 1.57"

Reverse Order Printing

Normally, received pages are printed and stacked on the tray in the order they are received. If you turn this feature on, the machine will start printing the message from the last page received. By default this feature is turned off. To switch it on, see "Initial Setup RX" on page 166. Note that when on, this feature will use Memory Reception.

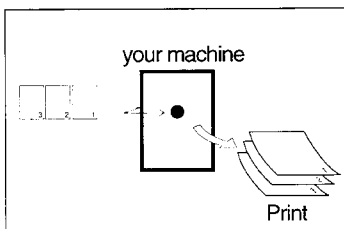

Page Reduction

If you have switched this feature on and you receive a message that is longer than the paper in the cassette, usually the machine prints it on two pages. In this feature the machine reduces the width and length of the received image so that it will fit on one page. If LT paper size is loaded and a message of LG size is received, the machine will reduce the message to a single LT sheet.

Cross-reference

“Length Reduction” ⇒ See page 73.

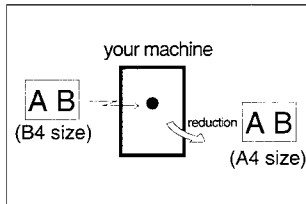

Hint

By default this feature is turned off. Switch it on with the User Parameters (see page 203).

TSI Print

Usually the sender's TTI is printed on received messages. If the sender has not programmed their TTI, you will not be able to identify them. However, if you turn this feature on, the sender's RTI or CSI is printed instead so you can find out where the message came from.

Hint

By default this feature is turned on. Switch it off with the User Parameters (see page 203).

CIL/TID Print (ISDN unit required)

Two features are provided for identification of messages received by G4 (ISDN). If turned on, this information will be printed on every page. Turn CIL and TID on and off with the User Parameters (see page 203). The CIL (Call Identification Line) refers to the combination of the receiver's own fax number, name, the sender's own fax number and name, the communication date, and page number. The default setting is on. The TID refers to the name registered by the sender in their TTI. The default setting is off.





Restriction

This feature is available only when receive in G4 mode.

Hint

As default CIL print is turned on. Switch it off with the User Parameters (see page 203).

When There Is No Paper Of The Correct Size

If there is no paper in your machine that matches the size of a received message, the machine will choose a paper size based upon the paper you have available. For example, if your machine has LG (8.5 × 14")  installed and you receive an LT (8.5 × 11")  size message, check the LT (8.5 × 11") column of the table below. The paper size at the top has the highest priority. In this case, since LG (8.5 × 14")  is higher priority than DLT (11 × 17") , the message is printed on LG (8.5 × 14") .

























Priority Table

Page Reduction	Disabled
Reduction in Sub-scan Direction	Enabled
Page Separation Threshold	20 mm
Width or Length Priority	Width

 : Image Rotation





 : Half of the page is blank

 : Page Reduction

		Received Image Size										
		A3	B4	A4	A4	B5	A5	11x17"	8.5x14"	8.5x11"	8.5x11"	F/F4
Paper Select Priorities	1	A3	B4	A4	A4	B5	A5	A3	8.5x14"	8.5x11"	A4	F/F4
	2	11x17"	A3	A4 	A4 	B5	8.5x11" 	11x17"	A4 	8.5x11" 	A4	8.5x14"
	3	A4	11x17"	F/F4	8.5x11" 	B4	8.5x11" 	A4	A4	A4	8.5x11" 	A4
	4	A4	B5	8.5x14"	8.5x11" 	A4	A4	A4	8.5x11" 	A4	8.5x11" 	A4
	5	8.5x11" 	B5	A3	A3	A4	A4	8.5x11" 	8.5x11" 	F/F4	A3	8.5x11" 
	6	8.5x11" 	A4	8.5x11" 	F/F4	8.5x11" 	F/F4	8.5x11" 	F/F4	8.5x14"	F/F4	8.5x11" 
	7	F/F4	A4	8.5x11" 	11x17"	8.5x11" 	8.5x14"	F/F4	B4	A3	11x17"	B4
	8	B4	8.5x11" 	B4	B4	F/F4	B5	B4	A3	B4	B4	A3
	9	8.5x14"	8.5x11" 	11x17"	8.5x14"	A3	B5	8.5x14"	11x17"	11x17"	8.5x14"	11x17"
	10		F/F4	A5		11x17"	A3		A5	A5		A5
	11		8.5x14"	B5		8.5x14"	B4		B5	B5		B5
	12			B5			11x17"		B5	B5		B5

 Lengthwise

 Sideways

-   and   indicate that the message is split over two pages of paper with the orientation and size shown.
- The mark () are rotated by 90° and printed using Image Rotation.

Hint

- Widths that this machine can receive are A4, B4, LT, LG, and A3. Any messages narrower than A4 or LT are sent as A4 or LT width with the length unchanged.

Restrictions

- Paper placed in the bypass tray is not usually selected for printing a received message. However, you can use this tray if you select the bypass tray as the main paper tray using Reception with Specified Senders (see page 83).
- The paper size used to print a received message may be different from the size of the sent original.

Cross-reference

- “Length Reduction” ⇒ See page 73.
- “Page Reduction” ⇒ See page 74.
- “Image Rotation” ⇒ See page 72.

Advanced Transmission Features

Overview

This feature describes various options that you can choose when sending a fax message. The selections you make will only apply to the current fax message.

SEND LATER

Choose the Send Later feature if you want your fax message sent at a time anywhere up to 23 hours 59 minutes later in the future. Once programmed, the machine will automatically send the message at the time you have specified. This allows you to take advantage of off-peak telephone charges without having to be by the machine at the time.

To facilitate this process, you can program the time when your phone charges become cheaper as the Economy Transmission time (see page 195). Then, for each non-urgent message, just select Send Later with Economy Transmission when scanning in, and your messages will start being automatically sent in the future.

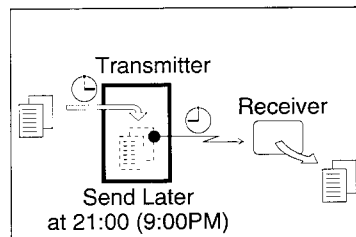

- If you wish to use Economy Transmission, program the time when your phone charges get cheaper (see page 195).
- This feature is only available with the memory transmission.

1 Place an original and select any scan settings you require.

2 Press [Mode].
 The Transmission Mode menu appears.

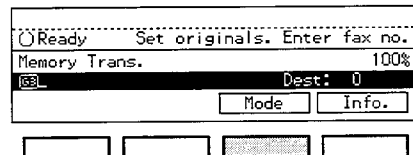

- 3** Enter the “Send Later” function number with number keys.

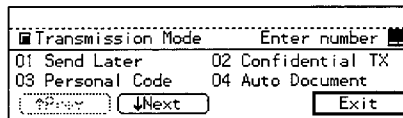

- 4** Enter the time with the number keys, or press [Economy TX]. Press [AM ↔ PM] to switch between AM and PM.

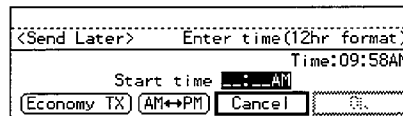

- Depending on your area, some machines may use the 24 hour clock and you do not have to press [AM ↔ PM]. For example, to enter 6PM, enter 18:00.

Hint

- If the current time shown on the display is not correct, adjust it. ⇒ See “Adjusting the Date and Time” on page 207.
- When entering numbers smaller than 10, add a leading zero.
- If you make a mistake, press the **Clear/Stop** key and try again.
- To cancel Send Later, press [Cancel] and the display will return to the Transmission Mode menu.

- 5** Press [OK].
- The Transmission Mode menu is shown on the display. A check mark is added to Send Later.

- 6** Press [Exit].
- The initial display is shown.

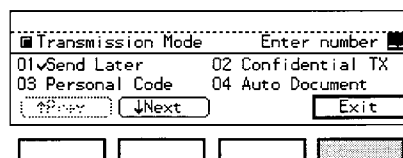

Hint

- “Send Later” is shown on the display. If you set up another advanced transmission function (except Polling Reception), “Other” is displayed.

- 7** Dial and press the **Start** key.



◆ **To cancel the specified time:**

Use a Canceling a Transmission function (see page 110).

CONFIDENTIAL TRANSMISSION

If you do not want your message to be picked up casually at the other end, use this feature. The message will be stored in memory at the other end and will not be printed until an ID is entered.

- The destination machine must be of the same make and have the Confidential Reception feature
- The destination machine must have enough memory available
- The receiver must program their Confidential ID beforehand
- An ID can be any 4 digit number except 0000

There are two types of Confidential Transmission:

- Default ID
- ID Override

◆Default ID

The other party can print the message by entering the Confidential ID programmed in their machine.

◆ID Override

Should you wish to send a confidential message to a particular person at the other end, you can specify the Confidential ID that that person has to enter to see that message. Before you send the message, don't forget to tell the intended receiver the ID that must be entered to print it.

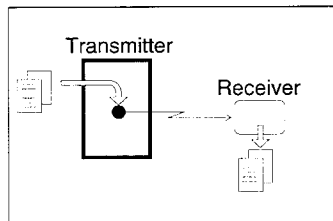

Before operation

- If you install the Memory Card or Hard Disk options, program the Confidential ID.
⇒ See "Registering the ID" in "FAX Initial Setup" on page 196.

1 Place an original and select any scan settings you require.

2 Press [Mode].
 The Transmission Mode menu appears.

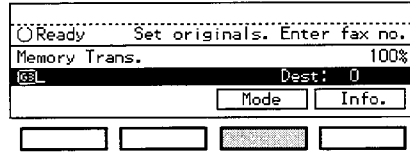

3 Enter the “Confidential TX” function number with the number keys.

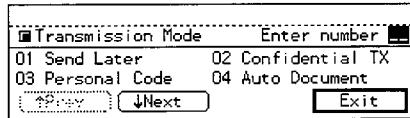

4 Depending on the Confidential Transmission type, use one of the following procedures:

Default ID

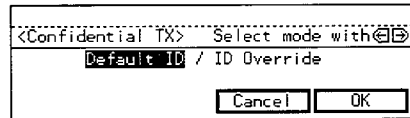

- 1** Press the or keys to turn Default ID on and press [OK].
- The Transmission Mode menu is shown again. A check mark is added to Confidential TX.



Hint

- To cancel the Confidential Transmission, press [Cancel]. The Transmission Mode menu is shown on the display.

Override ID

- 1 Press the  or  keys to turn Override ID on.

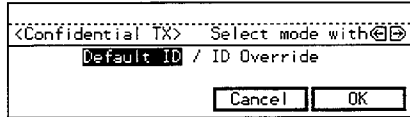

- 2 Enter the Confidential ID (4-digit number) with the number keys and press [OK].

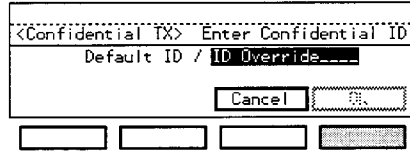

- The Transmission Mode menu is shown again. A check mark is added to Confidential TX.

Hint

- To Cancel the Confidential Transmission, press [Cancel]. The Transmission Mode menu is shown on the display.

- 5 Press [Exit].

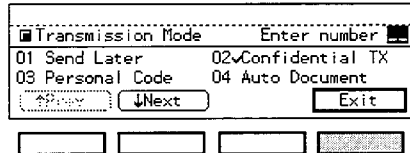

- The initial display is shown.



Hint

- "Conf. Trans" is shown on the display. If you set up another advanced transmission function (except Polling Reception), "Other" is displayed.

- 6 Dial and press the **Start** key.

PERSONAL CODE TRANSMISSION

Personal Codes allow you to keep track of machine usage (for example, for billing purposes). If everybody uses a Personal Code when they use the fax machine, the codes or the names programmed for the codes will be printed in the TCR (see page 123) and other reports. This will help you to check up on who has been using the machine and how often.

Restriction

- Personal codes may be any 4-digit number except 0000 (0001 through 9999). You can program up to 20 personal codes. If the Function Upgrade Card is installed, up to 50 personal codes can be programmed. ⇒ See “Registering the Personal Codes” on page 169.

1 Place an original and select any scan settings you require.

2 Press [Mode].
□ The Transmission Mode menu appears.

3 Enter a “Personal Code” function number with the number keys.

4 Enter a personal code (4-digit number) with the number keys.

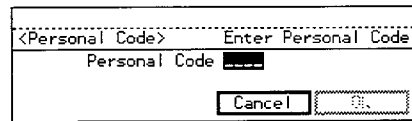
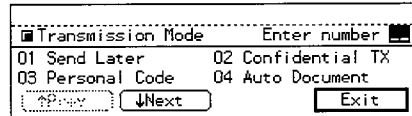
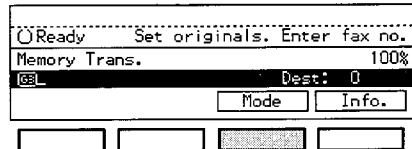

Hint

- If a personal code is programmed with a name, it is shown below the personal code on the display.
- If you make a mistake, press the **Clear/Stop** key and try again.
- To cancel the Personal Code Transmission, press [Cancel]. The Transmission Mode menu is shown on the display.

- 5** Press [OK].
- The Transmission Mode menu is shown again. A check mark is added to “Personal Code”.

- 6** Press [Exit].

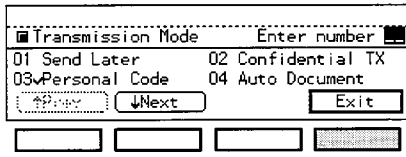

- The initial display is shown.



Hint

- “Pers. Code XXXX” is shown on the display. If you set up another advanced transmission function (except Polling Reception), “Other ” is displayed.

- 7** Dial and press the **Start** key.

SENDING AN AUTO DOCUMENT

If you often have to send a particular page to people (e.g. a map, a standard attachment or a set of instructions), store it as an Auto Document in a Quick Dial key. Then, when you need to send that page to somebody, you just press the Quick Dial that you stored it in instead of having to scan the whole page again. You can send only an Auto Documents or send it at the same time as sending another original.

IMPORTANT

- ❑ When you store or change an Auto Document, we recommend that print the Auto Document list (see page 159).

Restrictions

- ❑ A containing an Auto Document can be specified for each transmission.
- ❑ You can store up to 6 Auto Documents. ⇒ See “Registering and Deleting an Auto Document” on page 157.

Hint

- ❑ Originals with Auto Documents are sent by Memory Transmission.
- ❑ When sending an Auto Document with another original, the Auto Document is sent first.
- ❑ Storing Auto Documents reduces the amount of free memory slightly. If you need that memory, delete the Auto Documents.
- ❑ You can print an Auto Document or a summary of Auto Documents in memory. ⇒ See “Reports” on page 164.

1 Place an original and select any scan settings you require.

2 Press [Mode].
❑ The Transmission Mode menu appears.

3 Enter the “Auto Document” function number with the number keys.

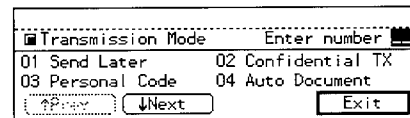
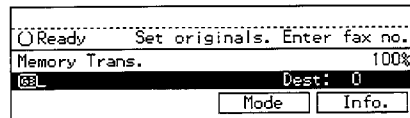

4 Enter the number of the Auto Document you want to send with the number keys.

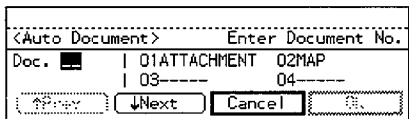

Hint

- If the list does not contain the Auto Document you want to send, press [Prev.] or [Next].
- If you make a mistake, press the **Clear/Stop** key and try again.
- To cancel the Auto Document, press [Cancel]. The Transmission Mode menu is shown.

5 If you are sending the Auto Document alone, press [OK]. If you wish to send it with another original, press [#].



6 Press [OK].

- The Transmission Mode menu is redisplayed. A check mark is added to "Auto Document".

7 Press [Exit].

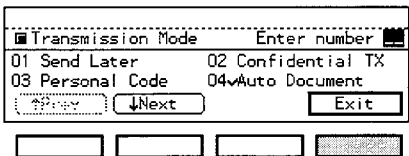

- The initial display is shown.

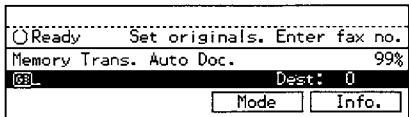

Hint

- "Auto Document" is shown on the display. If you set up another advanced transmission function (except Polling Reception), "Other" is displayed.

8 Dial and press the **Start** key.

2-SIDED TRANSMISSION (DOUBLE-SIDED TRANSMISSION)

Use to send 2-sided originals from the ARDF. Both sides of an original can be scanned. The front and back of the scanned original will be printed in order, on separate sheets at the other end. Notes, however that the orientation of alternate sheets will be reversed at the other end.

1 Place an original on the ARDF and select any scan settings you require.

2 Press [Mode].
 The Transmission Mode menu appears.

3 Enter the "2-Sided TX" function number with the number keys.

4 Press the or key, to select the first page you want scanned both sides.

5 Press [OK].

6 Press [EXIT].

The initial display is shown.

Hint

"2-Sided TX" is shown on the display. If you set up another advanced transmission function (except Polling Reception), "Other" is displayed.

7 Dial and press the Start key.

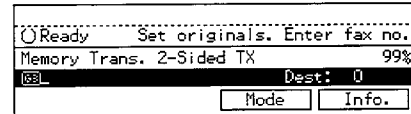
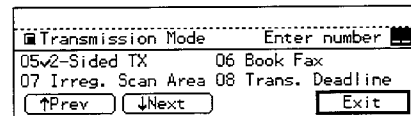
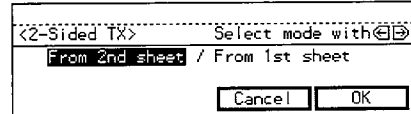
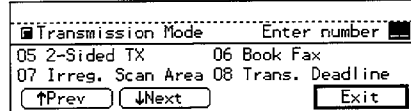
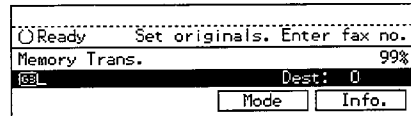

BOOK FAX

Use to send book originals from the exposure glass. Pages are scanned in the order shown below.

Note that depending on the paper sizes available on the destination machine, the message may be reduced when printed.

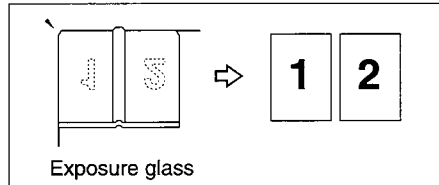

1 Place an original on the exposure glass and select any scan settings you require.

2 Press [Mode].
 The Transmission Mode menu appears.

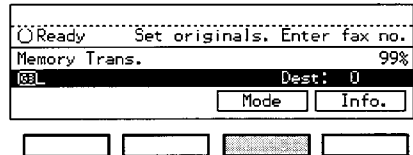

3 Enter the "Book Fax" function number with the number keys.

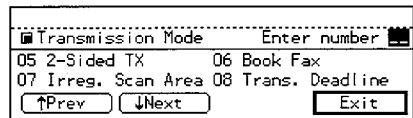

4 Press the or key to change the size of the original.

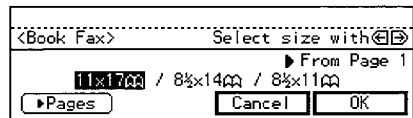

Hint

- To cancel this mode, press [Cancel]. The Transmission Mode menu is shown on the display.
- If you choose A3 , the original will be sent by Image Rotation Transmission.

- 5** Press [▶Pages] to toggle between from page 1 to from page 2 (see middle right corner of the display).

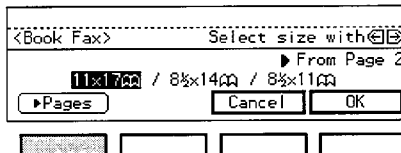

Hint

- Select "From Page 1" to send a book original from the first page. Select "From Page 2" if you want to send a cover letter as the first page.

- 6** Press [OK].
- The Transmission Mode menu is shown. A check mark is added to Book Fax.

- 7** Press [Exit].

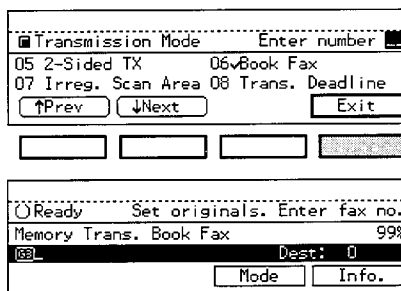

- The initial display is shown.

Hint

- "Book Fax" is shown on the display. If you set up another advanced transmission function (except Polling Reception), "Other" is displayed.

- 8** Dial and press the **Start** key.

Advanced Transmission Features

CHOOSING THE AREA TO BE SCANNED YOURSELF (IRREGULAR SCAN AREA)

Usually the machine automatically detects the size of an original when it is scanned. However, you may wish to override this and choose the area to be scanned yourself.

You can either choose one of the standard paper sizes (A4 , B4 , A3 , 8½ × 11" , 8½ × 14" , 11" × 17") or one of two custom sizes programmed in advance (Area 1 and Area 2). For more information on setting the custom sizes, see page 160.

Although you can specify a different scan area for each page when using the exposure glass, only one size is allowed when scanning from the ADF.

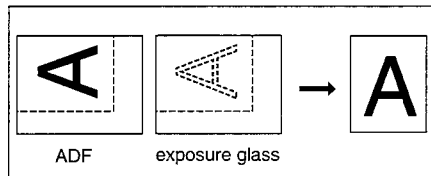

1 Place the original and select any scan settings you require.

2 Press [Mode].
 The Transmission Mode menu appears.

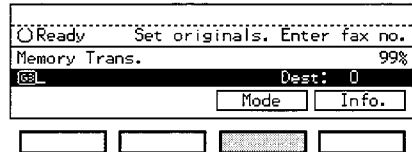

3 Enter the "Irreg. Scan Area" function number with the number keys.

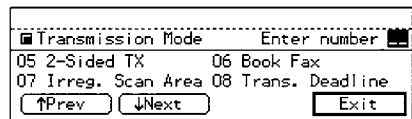

4 Press the or key to select the size.

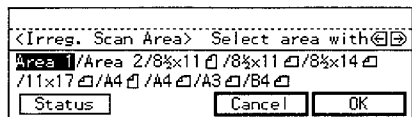

Hint

- ❑ To see what paper sizes have been programmed, press [Status].
- ❑ To cancel the Irregular Scan area setting, press [Cancel]. The Transmission Mode menu is shown.

5

Press [OK].

- ❑ The Transmission Mode menu is shown again. A check mark is added to Irregular Scan Area.

6

Press [Exit].

- ❑ The initial display is shown.

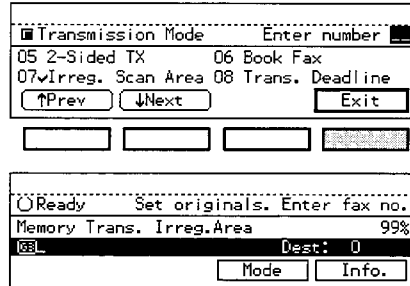

Hint

- ❑ “Irreg. Scan Area” is shown on the display. If you set up another advanced transmission function (Polling Reception), “Other” is displayed.

7

Dial and press the **Start** key.

Advanced Transmission Features

TRANSMISSION DEADLINE (TRD)

If you have to send a message before a certain time, specify the deadline for transmission. When it cannot be sent because the line is busy, for example, the machine redials at intervals of five minutes any number of times until the deadline passes. After the deadline passes, the Transmission Result Report is automatically printed. This indicates whether or not the message was sent within the deadline.

Restriction

- You can not specify deadline more than 24 hours into the future.

Hint

- If the message cannot be sent before the deadline and the number of redials is less than 5, the machine redials the remaining number of times and prints the Transmission Result report. If the number of redials has reached 5, the machine prints the Transmission Result report and stops transmission.

1 Place the original and select any scan settings you require.

2 Press [Mode].
 The Transmission Mode menu appears.

A screenshot of a machine's menu interface. At the top, it says "Ready Set originals. Enter fax no." Below that, "Memory Trans." is displayed with "99%" to its right. Underneath, "Dest: 0" is shown. At the bottom of the menu, there are two buttons labeled "Mode" and "Info." Below the menu, there are four empty rectangular boxes representing other menu options.

3 Enter the "Trans. Deadline (TRD)" function number with the number keys.

A screenshot of a machine's menu interface. At the top, it says "Transmission Mode Enter number". Below that, there are four menu items: "05 2-Sided TX", "06 Book Fax", "07 Irreg. Scan Area", and "08 Trans. Deadline". At the bottom, there are three buttons labeled "Prev", "Next", and "Exit".

4

Enter the deadline with the number keys. Press [AM ↔ PM] to toggle between AM and PM.

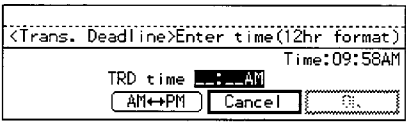

- Depending on the area, some machines may use the 24 hour clock and you do not have to press [AM ↔ PM]. For example, to enter 6PM, enter 18:00.

Hint

- If the current time on the display is not correct, adjust it. ⇒ See “Adjusting the Date and Time” on page 207.
- To enter a number smaller than 10, add a leading zero.
- If you make a mistake, press the **Clear/Stop** key and try again.
- To cancel the Transmission Deadline, press [Cancel]. The Transmission Mode menu is shown.

5

Press [OK].

- The Transmission Mode menu is shown. A check mark is added to Transmission Deadline (TRD).

6

Press [Exit].

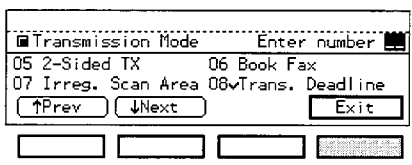

- The initial display is shown.

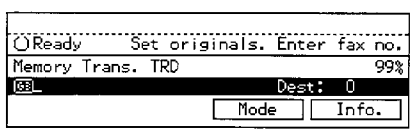

Hint

- “TRD” is displayed. If you set up another advanced transmission function (except Polling Reception), “Other” is shown.

7

Dial and press the **Start** key.

POLLING TRANSMISSION

Use Polling Transmission when you want to leave an original in the machine's memory for others to pick up. The message will be sent when the other party calls you up. There are three types of polling transmission: Free Polling, Default ID and ID Override.

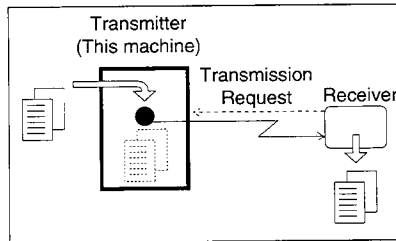

◆Free Polling Transmission

Anybody can poll the message from your machine.
The machine sends it regardless of whether Polling ID's match.

◆Default ID Polling Transmission

The message will only be sent if the Polling ID of the machine trying to poll your message is the same as the Polling ID stored in your machine.
Make sure that both machines' Polling ID's are identical in advance.

◆Override ID Polling Transmission

You must enter an Override Polling ID unique to this transmission. This ID overrides that stored in the Polling ID. The user must supply this ID when they poll your machine and if the ID's match, the message is sent. Make sure the other end knows the ID you are using in advance.

Restrictions

- Polling Transmission is allowed only if the receiver's machine has the Polling Reception feature. In Free Polling, a message can also be sent to other manufacturer's machines as long as they have the Polling Reception feature. With Default ID and Override ID Polling Transmission, an original can be sent only to a the machine of the same make with the Polling Reception feature.
- Free Polling and ID Polling Transmission allow only one file to be stored in memory. Personal ID Polling Transmission allows a file to be stored in memory for each ID; a total of up to 200 files for varying ID's can be stored.
- Before using "Default ID Polling Transmission" and "Override ID Polling Transmission" feature, program the polling ID.
- A polling ID may be any string of four numbers (0 to 9) and characters (A to F) except 0000 and FFFF.

Hint

- The communication fee is charged to the receiver.

1

Place an original and select any scan settings you require.

2

Press [Mode].

- The Transmission Mode menu appears.

3

Enter the “Polling TX” function number with the number keys.

4

Depending on the Polling Transmission type, use one of the following procedures:

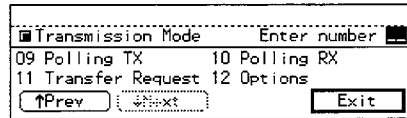
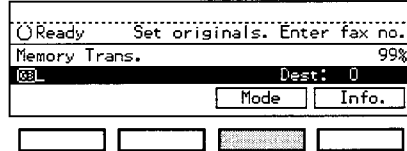

Advanced Transmission Features

Free Polling Transmission

- 1** Press the \leftarrow or \rightarrow key to select Free Poll and press [OK].

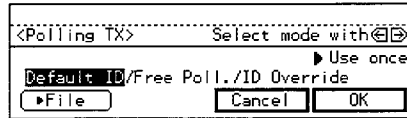

- 2** Press [\rightarrow File] and specify whether to save the stored original or not.

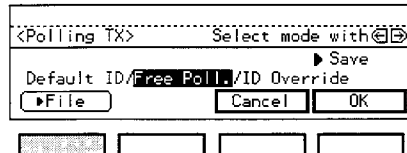

- Each time you press the key, the text at the middle right corner of the display toggles between Save and Use once.

Hint

- To delete the original immediately after transmission, select “Use once”. To repeatedly send the original, select “Save”.

Default ID Polling Transmission

1 Press the \leftarrow or \rightarrow key to select "Default ID" and press [OK].

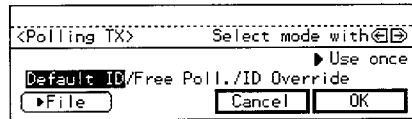

2 Press [\rightarrow File] and specify whether to save the stored original or not.

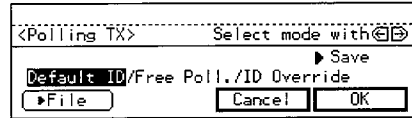

- Each time you press the key, the text at the middle right corner of the display toggles between "Save" and "Use once".

Hint

- To delete the original immediately after transmission, select "Use once". To repeatedly send the original, select "Save".

ID Override Polling Transmission

1 Press the \leftarrow or \rightarrow key to select ID Override and press [OK].

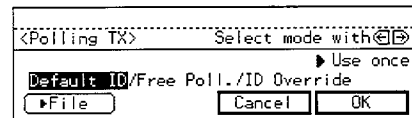

2 Enter a Polling ID (4 characters) with the number keys and Quick Dial keys.

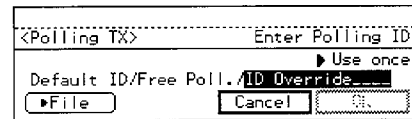

Hint

- If you make a mistake, press the **Clear/Stop** key and try again.

3 Press [\rightarrow File] and specify whether to save the stored original.

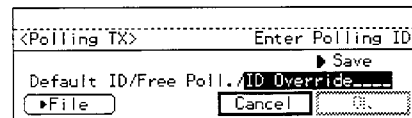

- Each time you press the key, the text at the middle right corner of the display toggles between "Save" and "Use once".

Hint

- To delete the original immediately after transmission, select "Use once". To repeatedly send the original, select "Save".

- 5** Press [OK].
- The Transmission Mode menu is shown. A check mark is added to Polling Transmission.

Hint

- To cancel the Polling Transmission, press [Cancel]. The Transmission Mode menu is shown.

- 6** Press [Exit].

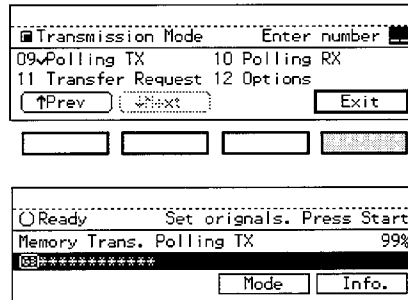

- The initial display is shown.

Hint

- "Polling TX" is displayed. If you set up other advanced transmission function (except Polling Reception), "Other" is displayed.

- 7** Press the **Start** key.

Polling Transmission Clear Report

This report allows you to verify whether polling transmission has taken place.

Restriction

- This report is not printed if the User Parameters (see page 203) are set to allow the stored originals to be repeatedly sent (Save).

Hint

- The User Parameters (see page 203) can be used to switch this report off. The default setting is on.
- By default, a portion of the sent image is printed on the report. You can turn this off with the User Parameters (see page 203).
- The result of a Polling Transmission can also be checked with the TCR.

POLLING RECEPTION

Use this function if you want to poll a message from another terminal. Furthermore, you can poll documents from many terminals with only one operation (use Groups and Keystroke programs to fully exploit this feature). There are two types of polling reception: Default ID and Override ID.

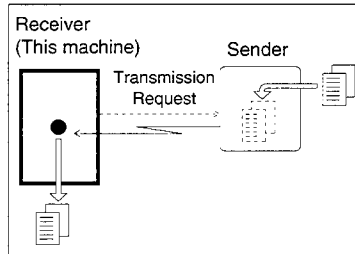

◆ Default ID Polling Reception (Free Polling Reception)

Use this method for Free Polling or Default ID Polling.

If the Polling ID is programmed in your machine, any messages waiting in the transmitting machine with the same ID are received.

If the other machine does not have any messages waiting with the same Polling ID, any messages that do not require ID are received (Free Polling).

◆ Override ID Polling Reception

You must enter an Override Polling ID unique to this transmission. This ID overrides that stored in the Polling ID.

Your machine will receive any messages waiting in the transmitting machine with matching ID's. If no ID's match, any messages that do not require ID are received (Free Polling).

Restrictions

- Polling Reception requires that the other machine can perform Polling Transmission.
- To receive a message sent by any Polling Transmission, it is necessary to specify the same polling ID as the sender's.
- To receive a message sent by Default ID Polling Transmission or Override ID Polling Transmission, the sender must use a machine of the same make that has the Polling capability. In Free Polling Reception, a message can be also received from other manufacturers' machines as long as it they have Polling capability.
- A Polling ID may be any four numbers (0 to 9) and characters (A to F) except 0000 and FFFF.

- 1 Press [Mode].
 - The Transmission Mode menu appears.

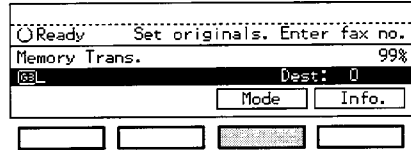

- 2 Enter the "Polling RX" function number with the number keys.

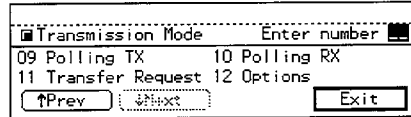

Hint

- If the appropriate display is not shown, press [↑Prev.] or [↓Next].

- 3 Depending which method you are using, choose one of the following procedures:

Default ID Polling Reception

- 1 Press the [←] or [→] key to change the Default ID and press [OK].

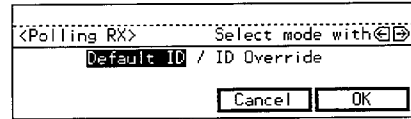

ID Override Polling Reception

- 1 Press the [←] or [→] key to change the Override ID and press [OK].

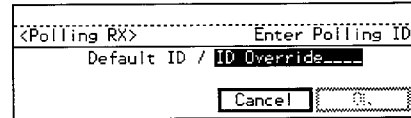

- 2 Enter a polling ID (4 characters) with the number keys.

Hint

- If you make a mistake, press the **Clear/Stop** key and try again.

- 4** Press [OK].
- The Transmission Mode menu is shown. A check mark is added to Polling Reception.

Hint

- To cancel Polling Reception, press [Cancel]. The Transmission Mode menu is shown.

- 5** Press [Exit].

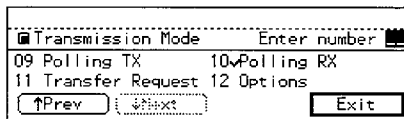

- The initial display is shown.

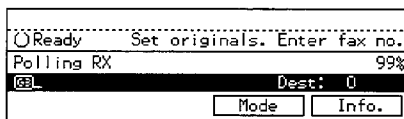

Hint

- "Polling RX" is displayed.

- 6** Dial and press the **Start** key.

Polling Reserve Report

This report is printed after Polling Reception has been set up.

Hint

- User Parameters (see page 203) can be used to switch this report on or off. The default setting is off.

Polling Result Report

This report is printed after a Polling Reception has been completed and shows the result of the Polling Reception.

Hint

- The result of a Polling Reception can also be checked with the TCR.
- The User Parameters (see page 203) can be used to switch this report on or off. The default setting is on.

TRANSFER REQUEST

Transfer Stations allow you to expand the standard features of your fax machine to set up complex networks. The following terminology is used in this section.

◆Requesting Party

The machine where the message originates from, i.e. the machine making a Transfer Request (in this section, this machine).

◆Transfer Station

The machine that forwards the incoming message to another destination, i.e. the machine that receives the Transfer Request.

◆End Receiver

The final destination of the message, i.e. the machine that the Transfer Station sends to. End Receivers must be programmed into Quick Dials, Speed Dials or Groups in the Transfer Station.

The diagram below may make the concept clearer.

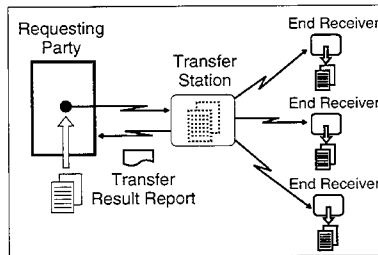

Restrictions

- The Transfer Stations you specify must be machines of the same make and have the Transfer Station function.
- You can specify up to 99 Transfer Stations in a Transfer Request.
- You can have up to 30 End Receivers per Transfer Station. If you specify a Transfer Station Group, the Group counts as a single receiver.
- The combined total of End Receivers and Transfer Stations you specify with the number keys cannot exceed 99.

Before operation

- Before you can use this feature you must program the Polling ID (see page 196) and your own dial number (see page 197).
- Polling ID's of the Requesting Party (this machine) and the Transfer Stations must be identical.

1 Set an original and select any scan settings you require.

2 Press [Mode].

- The Transmission Mode menu appears.

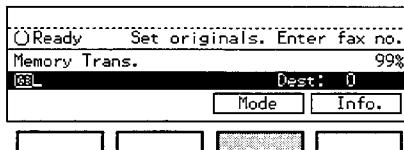

3 Enter the "Transfer Request" function keys.

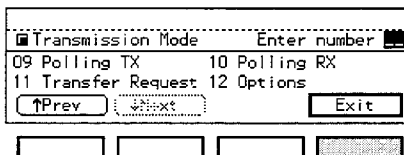

Hint

- If the appropriate display is not shown, press [Prev] or [Next].

4 Enter one or more Transfer Stations and press [Rcv. Stn].

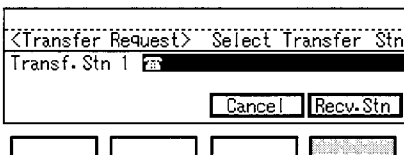

Hint

- Enter the fax numbers of the Transfer Stations with either Quick Dials, Speed Dials or the number keys.
- If you make a mistake, press the **Clear/Stop** key and try again.
- To cancel the Transfer Request, press [Cancel]. The Transmission Mode menu is shown again.

5 Enter one or more End Receivers.

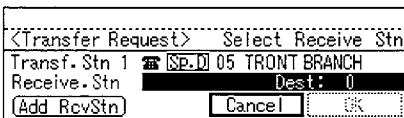

Hint

- ❑ You cannot enter the numbers of the End Receivers directly. The numbers must be stored in Quick Dials, Speed Dials or Groups in the Transfer Station(s). To specify an End Receiver, use the special format described on page 104.
- ❑ Press [Add RcvStn] if you wish enter more End Receivers.
- ❑ Press ◀ or ▶ to see the End Receivers already entered. You can select an End Receiver from this list and cancel it by pressing the **Clear/Stop** key.
- ❑ To cancel the Transfer Request, press [Cancel].

6

When you have specified all the End Receivers, press [OK].

7

If you want to enter an additional Transfer Station, press [Yes] and repeat steps 4 to 6.

- ❑ If you press [No], the Transmission Mode menu is shown and a check mark is added to Transfer Request.

8

Press [Exit].

- ❑ The initial display is shown.

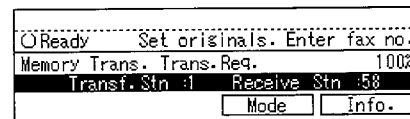
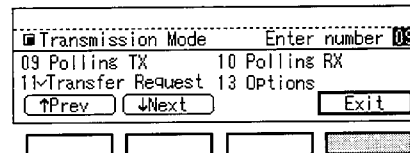
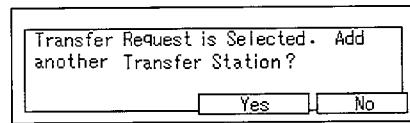

Hint

- ❑ The numbers of Transfer Stations and End Receivers are displayed.

9

Press the **Start** key.

Specifying an End Receiver

When you make a Transfer Request, you must specify the final destinations (End Receivers) for your message.

You cannot enter the numbers of the End Receivers directly. Instead, enter a simple code that describes where the numbers are stored in the Transfer Station (in Quick Dials, Speed Dials or Groups).

The numbers must first have been stored in Quick Dials, Speed Dials or Groups in the Transfer Station(s).

◆Quick Dial

Enter [#] followed by the number (2 digits) of the Quick Dial where the End Receiver is stored.

e.g. to choose the number stored in Quick Dial 01 in the Transfer Station,
enter: [#] [0] [1]

◆Speed Dial

Enter [#], [*] followed by the Speed Dial code (2 digits).

e.g. to choose the number stored in Speed Dial 12 in the Transfer Station,
enter: [#] [*] [1] [2]

◆Group Dial

Enter [#], [*], [*] followed by the Group number (2 digits).

e.g. to choose the number stored in Group 04 in the Transfer Station,
enter: [#] [*] [*] [0] [4]

TRANSMISSION OPTIONS

You can turn them on and off for any particular transmission by following the procedure at the end of this section.

In addition, if you frequently use a certain configuration of options, you can change the default home position (on or off) of each option with the User Parameters (see page 203).

◆TTI (Transmit Terminal Identification) Print

By default, the machine adds this identification on each sending message. The TTI is the sender's identification. You can program your own TTI to be printed on messages you send with the Key Operator Settings (see page 169).

Hint

- You can switch this feature off with the User Parameters (see page 203).

◆Label Insertion

With this feature you can have the receiver's name printed on the message when it is received at the other end. The name will be printed at the top of the page and will be preceded by "To".

Program the receiver's name and number in a Quick Dial or Speed Dial with Label Insertion turned on.

Before operation

- Program the name and number, see page 169 and 197.

◆Auto Reduction

By default, if the receiver's paper is smaller than the paper you are sending on, the message is automatically reduced to fit on the receiver's paper.

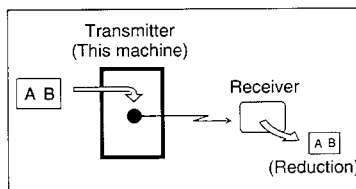

IMPORTANT

- If you turn this feature off, the scale of the original is maintained and some parts of the image may be lost when printed at the other end.

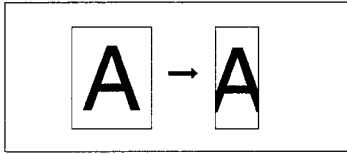

Hint

- You can switch this feature on and off with User parameters (see page 203). The default setting is on.

◆ID Transmission

If you turn this feature on, transmission will only take place if the destination's Polling ID is the same as yours. This feature can stop you from accidentally sending information to the wrong place (you need to co-ordinate Polling ID's with the other party).

Hint

- You can switch this feature on and off with the User Parameters (see page 203). The default setting is off.

Selecting Transmission Options for a Single Transmission

1 Set the original and select any scan settings you require.

2 Press [Mode].
 The Transmission Mode menu appears.

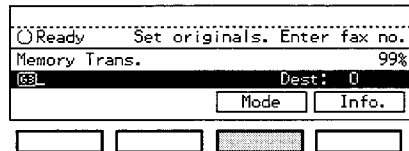

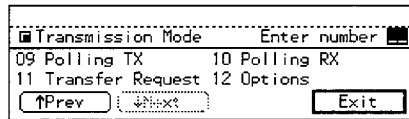

3 Enter the "Options" function number with the number keys.



Hint

- If "Options" is not shown, press [↑Prev.] or [↓Next].

- 4** Press the  or  key to switch TTI Print on or off.

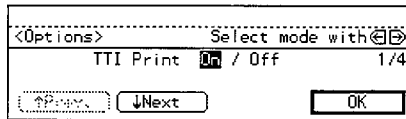



Hint

- The default setting is on.

- 5** If you want to set another option, press [**<Down>Next**].

Hint

- To quit, go to step 12.

- 6** Press the  or  key to switch Label Insertion on or off.

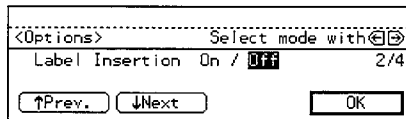



Hint

- The default setting is off.
- To cancel the changes, press [**Cancel**]. The Transmission Mode menu is shown.

- 7** If you want to set another option, press [**<Up>Prev.**] or [**<Down>Next**].

Hint

- To finish, go to step 12.

- 8** Press the  or  key to switch Auto Reduction on or off.

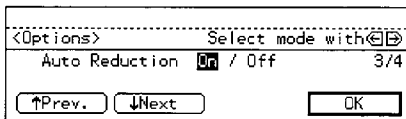



Hint

- The default setting is on.
- To cancel the setting, press [**Cancel**]. The Transmission Mode menu is shown.

- 9** When you want to set another option, press [**<Up>Prev.**].

Hint

- To finish option setting, go to step 12.

10 Press the  or  key to switch closed network on or off.

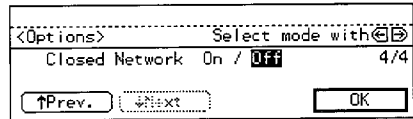

11 If you want to set another option, press [Prev.].

Hint

- To finish option setting, go to step 12.

12 Press [OK].
 □ The Transmission Mode menu is shown. A check mark is added to Options.

13 Press [Exit].

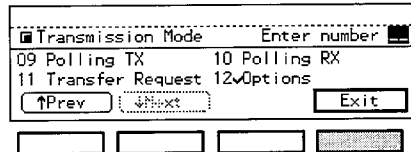

- The initial display is shown.

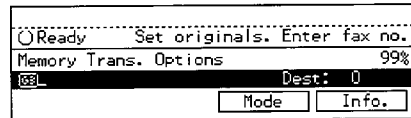

Hint

- "Options" is shown. If you set up another advanced transmission function (except Polling Reception), "Other" is shown.

14 Dial and press the **Start** key.

Free Manuals Download Website

<http://myh66.com>

<http://usermanuals.us>

<http://www.somanuals.com>

<http://www.4manuals.cc>

<http://www.manual-lib.com>

<http://www.404manual.com>

<http://www.luxmanual.com>

<http://aubethermostatmanual.com>

Golf course search by state

<http://golfingnear.com>

Email search by domain

<http://emailbydomain.com>

Auto manuals search

<http://auto.somanuals.com>

TV manuals search

<http://tv.somanuals.com>