

USER GUIDE



**HD TERMINAL
4642**

**HD PERSONAL VIDEO
RECORDER 8642**

DIGITAL TV



illico

HD



A Quebecor Media Company

IMPORTANT RULES FOR SAFE OPERATION	4
AVAILABLE TERMINALS	5
REMOTE CONTROL	8
CONNECTIONS	10
CONNECTION NO. 1: CONNECTS YOUR TERMINAL (HD OR HD PVR) TO AN HD TV	10
CONNECTION NO. 2: CONNECTS YOUR TERMINAL (HD OR HD PVR) TO AN HD TV AND A DVD READER/RECORDER.....	11
CONNECTION NO. 3: CONNECTS YOUR TERMINAL (HD OR HD PVR) TO A SURVEILLANCE CAMERA.....	12
ILILCO ON DEMAND	13
ORDERING A MOVIE OR A SHOW	13
TO RESUME WATCHING	13
ACTIVATING PARENTAL CONTROL	13
INTERACTIVE PROGRAM GUIDE	14
PARENTAL CONTROL	16
TO BLOCK VIEWING TIMES	16
TO BLOCK CHANNELS	16
TO BLOCK TYPES OF PROGRAMS	16
ACTIVATING PARENTAL CONTROL	16
ADJUSTING THE VOLUME	17
AUDIO SIGNAL EMITTED BY YOUR TERMINAL	17
SETTING LEVELS FOR BETTER SOUND QUALITY	17
PAY-PER-VIEW	18
PARENTAL CONTROL	18
PERSONAL VIDEO RECORDER	19
LIVE TV CONTROL: HOW TO CONTROL A LIVE PROGRAM THAT YOU ARE WATCHING	20
HOW TO RECORD AND STORE A PROGRAM	21
SAVE TIME	24
HOW TO DELETE A RECORDED PROGRAM OR A SCHEDULED RECORDING	25
PICTURE-IN-PICTURE (PIP) – HOW TO WATCH TWO PROGRAMS AT ONCE	25
RECORDING CAPACITY	26
SETTINGS	27
FREQUENTLY ASKED QUESTIONS	28
TERMINAL	28
FUNCTIONS	28
PERIPHERALS	28
REMOTE CONTROL	28
SOUND AND IMAGE	29
SURVEILLANCE CAMERA	29
FRONT PANEL DISPLAY	30
PAY-PER-VIEW AND PIN	30
LIST OF CODES	31
CUSTOMER SERVICE	34
HIGH-DEFINITION SETUP	35
SETUP	35
CONNECTORS	35
SETUP WIZARD	36
INTRODUCING THE SETUP WIZARD	36
PICTURE FORMATS	36
SETTING UP YOUR HD TERMINAL WITH THE SETUP WIZARD	40
CLOSED-CAPTIONING	47
FREQUENTLY ASKED QUESTIONS	48

IMPORTANT RULES FOR SAFE OPERATION

Carefully read through these rules for safe operation before hooking up the terminal.

PLACEMENT AND VENTILATION

The unit has openings for ventilation that protect it from overheating.

- Avoid obstructing these openings, and do not place other equipment, including televisions, lamps, books or any other object, on the unit. Do not place it in an enclosure such as a bookcase or equipment rack, unless the installation provides proper ventilation.
- Do not place the unit on a bed, sofa, rug or similar surface, or over a radiator or heat register.
- Place the unit on a stable surface able to support its size and weight.

ACCESSORIES AND CLEANING

Do not use accessories with this equipment unless recommended by your cable service provider. Do not open the cover of the unit. Unplug the unit and clean it with a damp cloth. Do not use a liquid or aerosol cleaner, or a magnetic/static cleaning device.

OBJECT AND LIQUID ENTRY

Do not expose the unit to moisture, or spill liquids on or near it. Do not place the unit on a wet surface. Never push objects of any kind into the unit's openings, as they may touch dangerous voltage points or cause short-circuits that could result in a fire or electric shock.

POWER SOURCES

A label on the unit indicates the correct power source for this equipment. Operate the unit only from an electrical outlet that has the voltage and frequency indicated on the label. Do not overload electrical outlets or extension cords, as this can result in a risk of fire or electric shock.

POWER CORD PROTECTION

Arrange all power cords so that people cannot walk on the cords or place objects on or against the cords, as this may damage them. Pay particular attention to cords that are at plugs, at electrical outlets, connected to accessories, and at the places where the cords exit the unit.

GROUNDING

The terminal has a two-prong plug. Properly ground the unit by inserting the plug into a grounded electrical, two-socket outlet. If the plug is polarized, it has one wide prong and one narrow prong. This plug fits only one way.

Caution! To prevent electric shock, match wide blade of plug to wide slot, then fully insert. If you are unable to insert this plug fully into the outlet, contact an electrician to replace your obsolete outlet.

SERVICING

The terminal has a standard warranty of three years. Opening the case will void your warranty. Refer all servicing to a qualified Vidéotron technician. Contact your cable service provider for instructions. Service should be referred to a Vidéotron technician when any of the following occurs:

- There is damage to the power cord or plug.
- Liquid enters the unit, or there is exposure to rain or water.
- A heavy object falls on the unit, or you drop the unit or damage the cabinet.
- Operation is not normal (the instructions in this guide describe the proper operation).
- The unit exhibits a distinct change in performance.

Extended Warranty

For greater peace of mind, Vidéotron offers you the possibility of extending the warranty for an additional two years. Customers who want this extended warranty must apply for it within 30 days of the service activation date. The unit purchased will then be covered for a total of five years following the activation date.

THE TERMINALS OFFER THE SAME HIGH-PERFORMANCE CAPABILITIES, INCLUDING:

- an exceptional HD image that supports resolutions of up to 1080i and is able to support a resolution of 1080p,
- Dolby Digital™ 5.1 surround sound adapted for home theatre systems,
- a complete Interactive Program Guide providing an overview of the programming for the next days,
- the ability to block access to specific times, channels or TV programs with the Parental Control feature,
- access to interactive TV, as well as a multitude of advanced features and services,
- access to Video On Demand, where available.



AVAILABLE TERMINALS

HD TERMINAL 4642

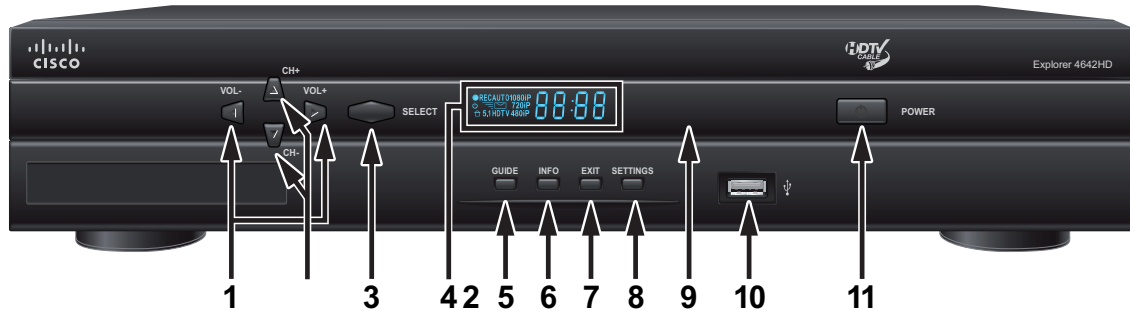

- 1 **VOL +, VOL -** Increases and decreases the volume
- 2 **CH+, CH -** Scrolls up and down through the channels
- 3 **Select** Confirms your selection
- 4 **Display** Displays the current channel number and time of day. The display shows the following:
 - Record (●REC) • Auto • 1080i / 1080P • MoCA Link (⬇)
 - Power (⏻) • Message (✉) • 720i / 720P
 - 5.1 • HDTV • 480i / 480P
- 5 **Guide** Displays the Interactive Program Guide
- 6 **Info** Displays a description of the selected program. This button is available from the on-screen guide and while viewing a program
- 7 **Exit** Exits the menus, the on-screen guide, and program information
- 8 **Settings** Provides access to the Settings menu
- 9 **IR Sensor** Receives the infrared signal from the remote control
- 10 **USB Port** Connects to the external USB equipment (reserved for future use)
- 11 **Power** Turns the set-top box on and off



HD PERSONAL VIDEO RECORDER 8642

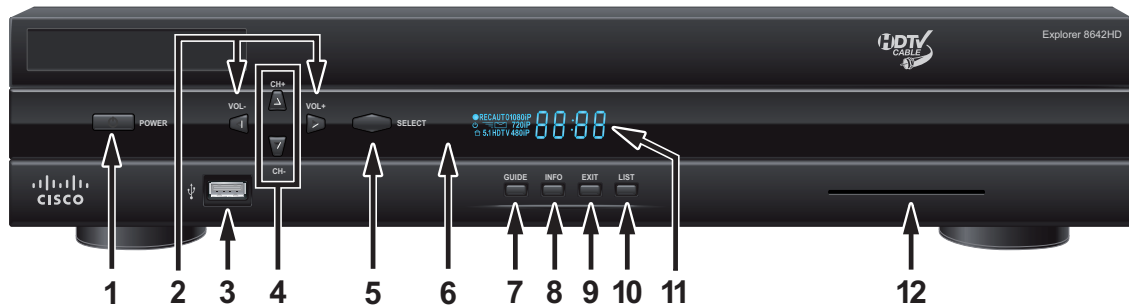

- 1 **Power** Turns the set-top box on and off
- 2 **VOL +, VOL -** Decreases and increases the volume
- 3 **USB 2.0** Connects to the external USB equipment approved by your service provider (reserved for future use).
- 4 **CH+, CH -** Scrolls up and down through the channels
- 5 **Select** Confirms your selection
- 6 **IR Sensor** Receives the infrared signal from the remote control
- 7 **Guide** Displays the Interactive Program Guide
- 8 **Info** Displays a description of the selected program. This button is available from the on-screen menu and while viewing a program
- 9 **Exit** Exit the menus, the on-screen menu, and program information
- 10 **List** Displays the recorded list
- 11 **Display** Displays the current channel number and time of day. The display shows the following:
 - Power (⏻)
 - Message (✉)
 - Record (●REC)
 - MoCA Link (⚡)
 - HDTV
 - Auto
 - 1080i / 1080P
 - 720i / 720P
 - 480i / 480P
 - 5.1
- 12 **Smart Card** Allows smart card access (reserved for future use)



REMOTE CONTROL

REMOTE CONTROL RT-U63P-15

For best results, we recommend reading the next page to correctly program your remote control in conjunction with your TV set.

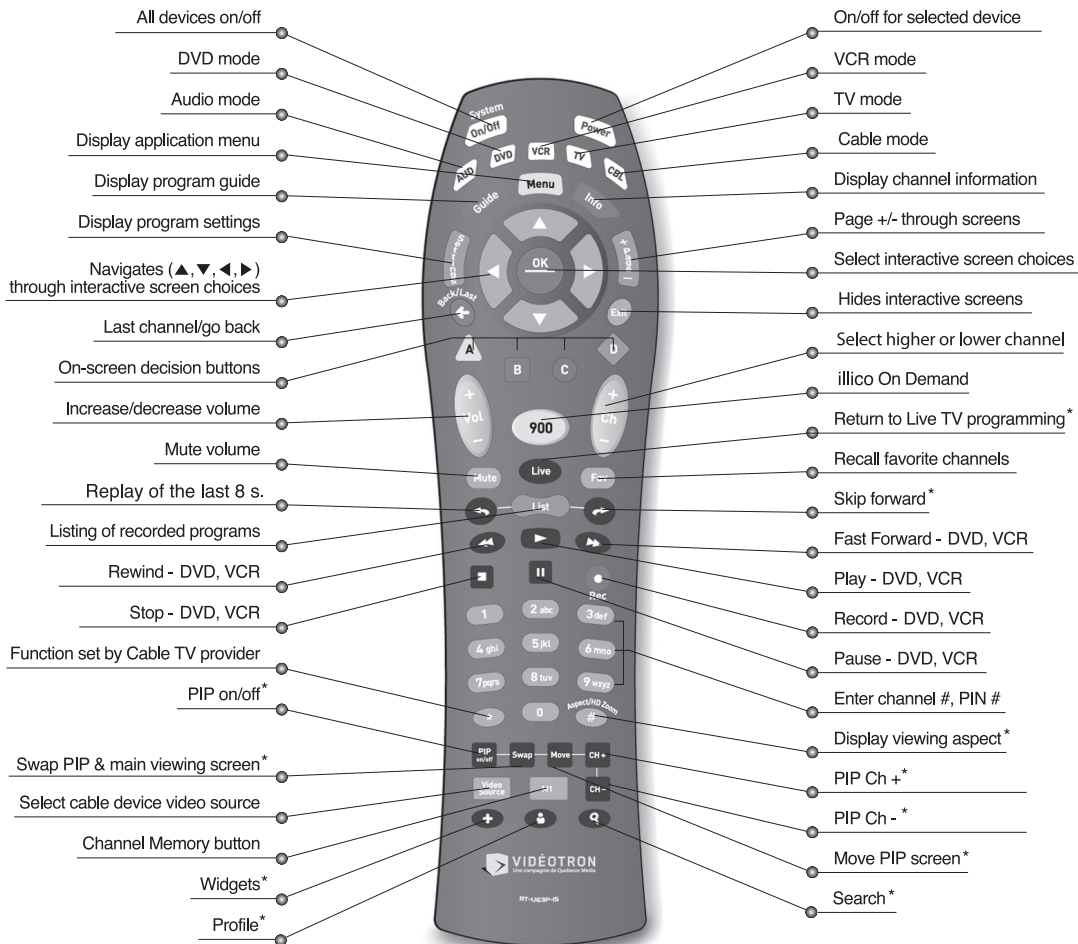

The remote control requires two AA alkaline batteries. A diagram inside the compartment of the remote control indicates proper battery placement. Replace as needed, when the indicator light becomes dim or no longer illuminates.

PROGRAMMING THE RT-U63P-15 REMOTE CONTROL

For more information, see the *Programming and operating instructions* manual that came with your terminal.

QUICK PROGRAMMING

This method allows you to program the remote control without using codes. Instead, the remote control automatically searches for the correct code that operates your device.

When using this method, there are several important points to remember:

- The order in which you program your electronic devices is not important.
- There may be several codes that turn your electronic devices on/off (or perform other functions). Once you lock in a code, be sure to check the available functions for that device (e.g. TV (Vol +/-, Mute), TV Input (Video Source button), VCR (Play, Stop, etc.), DVD (Play, Stop, etc.), AUDIO (Vol +/-, Mute)) to see if they are operating.
- While the remote is searching for the correct setup code(s) for your electronic devices, it is possible that other (previously programmed) devices may turn on/off. If this occurs, continue pressing the **CH +** or **CH -** buttons until you find the correct code for the device you are programming.
- It may take several minutes for the remote to find the correct code that turns your device off (or performs another selected function). During this time, the **POWER/MODE** buttons will light up in fast rotation (i.e. CBL > TV > VIDEO > AUDIO).

PROGRAMMING YOUR REMOTE CONTROL USING THE CH + OR CH - BUTTONS

1. Turn on all the electronic devices (TV, VCR, DVD, AUDIO) you want to program the remote to operate.
2. Press **SELECT** then **MUTE** together until the CBL/TV/VCR/AUDIO buttons light up in a slow rotation.
3. Press and hold the **CH +** button until one device turns off. While you are pressing the **CH +** button, the CBL/TV/VCR/AUDIO buttons will light up in fast rotation. As soon as one device turns off, release the **CH +** button.
4. Press **MUTE**. If the device that turned off:
 - a. Turns back on, press **SELECT** to lock in this code. The CBL/TV/VCR/AUDIO buttons will blink 3 times and go out.
 - b. **Does not turn back on**, press **CH -** repeatedly until that device turns back on. Each time you press the **CH -** button, the CBL/TV/VCR/AUDIO buttons will light up once in a reverse fast rotation.
5. Once you have found a code that turns the device on/off, press **SELECT** to lock in this code. The CBL/TV/VCR/AUDIO buttons will blink 3 times and go out.
6. Repeat steps 2 to 5 above for each of the remaining electronic devices you wish to program the remote to operate.

CONNECTIONS

CONNECTION NO. 1: CONNECTS YOUR TERMINAL (HD OR HD PVR) TO AN HD TV

THIS CONNECTION WILL ALLOW YOU TO:

- Watch the channel or service of your choice (in HD, when available),
- Record programs on the hard drive while they are playing, allowing the use of the Live TV control functions (in HD, when available),
- Watch a program previously recorded on the hard drive (in HD, when available),
- Record a show from one channel on the hard drive while watching another channel (in HD, when available),
- Record two shows from two different channels on the hard drive while watching a third previously recorded program (in HD, when available),
- Program your PVR to record one program or two programs simultaneously while you're away (in HD, when available).

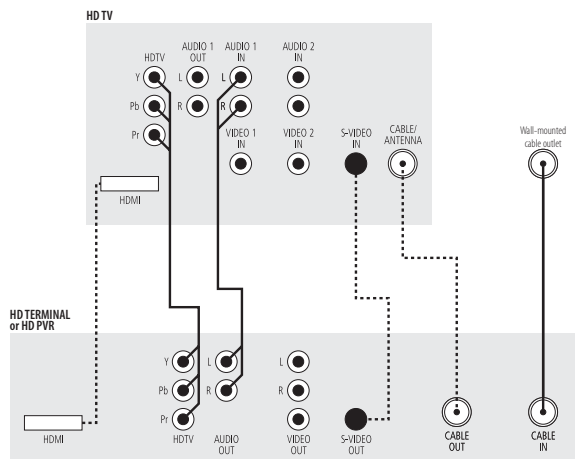

Notes:

- The best possible connection with the cables supplied is illustrated by the solid lines. The dotted lines represent viable options.
- Although the rear of the terminal depends on the model (sockets in different positions), the connection is done in the same way.
- You should turn the terminal volume all the way up and adjust the volume on the TV to your taste. For explanations, see the "Volume adjustment" section on page 17.

CONNECTION NO. 2: CONNECTS YOUR TERMINAL (HD OR HD PVR) TO AN HD TV AND A DVD READER/RECORDER

THIS CONNECTION WILL ALLOW YOU TO:

- Watch the channel or service of your choice (in HD, when available),
- Record programs on the hard drive while they are playing, allowing the use of the Live TV control functions (in HD, when available),
- Watch a program previously recorded on the hard drive (in HD, when available),
- Record a show from one channel on the hard drive while watching another channel (in HD, when available),
- Record two different shows from two different channels on the hard drive while watching a third previously recorded channel (in HD, when available),
- Program your PVR to record one program or two programs simultaneously while you're away (in HD, when available),
- Transfer the contents of your hard drive onto a DVD for archiving,
- View the contents of a DVD.

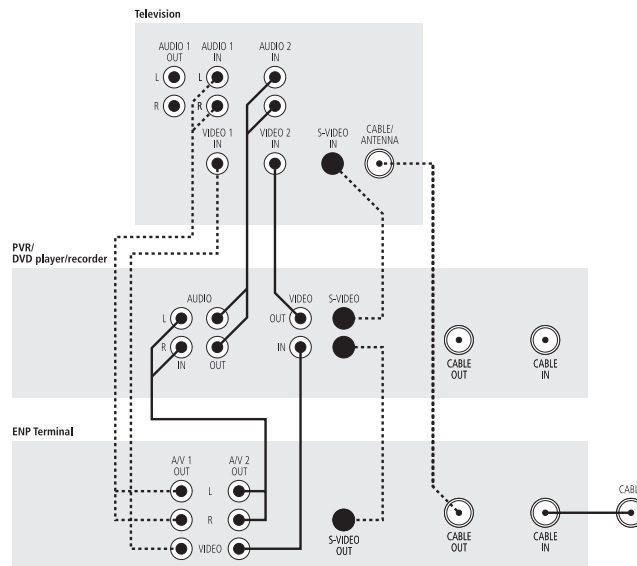

Notes:

- The best possible connection with the cables supplied is illustrated by the solid lines. The dotted lines represent viable options.
- Although the rear of the terminal depends on the model (sockets in different positions), the connection is done in the same way.
- You should turn the terminal volume all the way up and adjust the volume on the TV to your taste. For explanations, see the "Volume adjustment" section on page 17.

CONNECTIONS

CONNECTION NO. 3: CONNECTS YOUR TERMINAL (HD OR HD PVR) TO A SURVEILLANCE CAMERA

ALL OF THE TERMINALS ALLOW VIEWING OF IMAGES TRANSMITTED BY YOUR BUILDING'S SURVEILLANCE CAMERAS.

- On any terminal simply tune your receiver to channel 950.
- You will need to add a splitter and connect it as follows (see diagram below).

THIS CONNECTION WILL ALLOW YOU TO:

- Watch the channel or service of your choice
- Watch the images transmitted by the surveillance camera

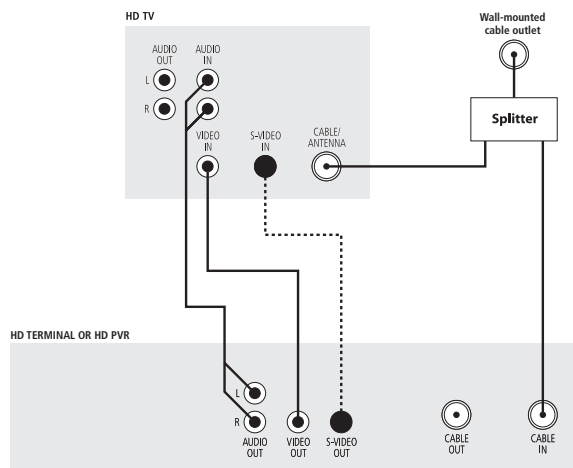

Notes:

- The best possible connection with the cables supplied is illustrated by the solid lines. The dotted lines represent viable options.
- Although the rear of the terminal depends on the model (sockets in different positions), the connection is done in the same way.
- You should turn the terminal volume all the way up and adjust the volume on the TV to your taste. For explanations, see the "Volume adjustment" section on page 17.



illico On Demand is your first source for movies, shows, popular TV series, comedy shows and more. illico On Demand offers you the greatest selection of bilingual content, available whenever you want it. You will find:

- Over 6,000 regularly updated titles, including more than 2,000 free titles
- The most recent box-office hits
- The latest movies, as soon as they are released on DVD

The features available while watching a movie or a TV show on illico On Demand are the same as on your DVD reader.



1. Pause



4. Stop



2. Play



5. Fast-forward



3. Rewind

ORDERING A MOVIE OR A TV SHOW

1. Press  or tune in to channel 900.
2. Choose a category or a subcategory and a title and press **SELECT** after each choice.
3. Press **SELECT** to order the movie, enter your PIN and press **SELECT**. The default PIN is 0000.
4. Press **PLAY** to confirm the order and start the movie. **To cancel the order** at this point, press **C**. Once past this step, the movie rental cannot be cancelled.

TO RESUME VIEWING

1. In the **illico On Demand menu**, on channel 900, select **Resume Viewing** and press **SELECT**.
2. Choose the title and press **SELECT**; the movie will start where you left off.
3. To watch the movie from the beginning, press **REWIND**.
4. To exit illico on Demand, press **EXIT**.

The time indicated next to a title shows the time remaining on your rental. You may also resume viewing the film or TV show you've paused on illicoweb.tv (if you have Videotron's Internet service) or on illico mobile (if you have a 3G mobile phone from Videotron).

ACTIVATING PARENTAL CONTROL TO BLOCK OUT MOVIES BASED ON THEIR TYPE

1. Press **SETTINGS** twice.
2. Select **BLOCK: RATING** and press **SELECT**.
3. Enter your parental PIN (the default PIN is 0000) and follow the instructions on the screen.
4. You can block one or more type of movie ratings to avoid unpleasant surprises.

INTERACTIVE PROGRAM GUIDE

Press the **GUIDE** button and the Interactive Program Guide (IPG) displays the list of upcoming programs for the next days. These programs can be sorted by **channel**, **theme** or **title**.

Current channel

Title and broadcast time of selected program

Browse by channel, theme, title

Browsing instructions

Current program

Program titles and upcoming schedule

Displayed schedule date

CHAINE	8h00	8h30	9h00
CBFT 2	Tous les matins		Ricardo
CIVM 3	Mme Cerise	Teletubbies	
TVA 4	Salut Bonjour!		Michel Jasmin
CFJP 5	Le mec à dames		Dynastie
CBMT 6	Cyberchase	Mr. Dressup	Zoboomafoo

A Voir par... B Date mer 25-9

FOR INFORMATION ON THE PROGRAM

1. When the guide is on-screen, use the arrows (← ↑ → ↓) to select the desired program.
2. Press the **INFO** button for more information.





HOW TO BROWSE BY THEME

1. When the guide is on-screen, press **△**, choose **Theme**, then press **SELECT**.
2. Press the ← arrow, choose a theme and press **SELECT**.
3. Use the ↑ and ↓ arrows to move through the titles.

HOW TO BROWSE BY CHANNEL

1. Press **GUIDE**; the program you are watching is highlighted.
2. Use the ↑ and ↓ arrows to move through the channels, and the ← and → arrows to move through the time slots.

HOW TO BROWSE BY TITLE

1. When the guide is on-screen, press , choose **Title**, then press **SELECT**.
2. Press the , choose the first letter of the program in question and press **SELECT**.
3. Use the  and  arrows to move through the titles.
 - **To tune the selected program in the current time slot**, highlight it and press **SELECT**.
 - **To view the schedule for the next days**, press , highlight the date for the available day, then press **SELECT**.

At any time, you can press the **INFO** button twice for more information on the selected program. After browsing through the IPG, press  to go back to where you started.

HOW TO SCHEDULE A REMINDER

1. Press **GUIDE**, highlight a program and press **SELECT**.
2. Highlight **Set a Reminder** and press **SELECT**; the chosen title is now in green.

PARENTAL CONTROL

With the parental control feature, you can block:

1. Certain viewing times
2. Specific channels
3. Some types of programs

All you need is your PIN!

TO BLOCK VIEWING TIMES

1. Press **SETTINGS** twice, select BLOCK: TIME NEW and press **SELECT**.
2. Determine blocked times by following the instructions on-screen.

TO BLOCK CHANNELS

1. Press **SETTINGS** twice, select BLOCK: CHANNELS and press **SELECT**.
2. Determine blocked channels by following the instructions on-screen.

TO BLOCK TYPES OF PROGRAMS

1. Press **SETTINGS** twice, select BLOCK: RATINGS and press **SELECT**.
2. Determine blocked types of programs by following the instructions on-screen.

ACTIVATING PARENTAL CONTROL

Once you have determined the channels, times and types of programs to be blocked, you need to activate the parental control feature by following the steps below:

1. Press **SETTINGS** twice, select BLOCK: PIN, choose the ENABLE feature and press **SELECT**.
2. Press **△** and enter your PIN.

TO DEACTIVATE THIS FEATURE, FOLLOW THE INSTRUCTIONS BELOW:

1. Press **SETTINGS** twice, select BLOCK: PIN, choose DISABLE and press **SELECT**.
2. Press **△** and enter your PIN to disable (or change) the feature.
3. At this step, you can also change your PIN by selecting CHANGE.

You can also unblock access to a blocked channel by tuning it in and following the instructions on the screen.

Note: Your default PIN is 0000.

AUDIO SIGNAL EMITTED BY YOUR TERMINAL

By adjusting the volume on your TV, you determine the loudness of the sound coming from your speakers. With your terminal, however, the VOLUME feature adjusts the power of the audio signal coming from your terminal. This signal then enters your TV or audio system at the programmed level. This is why it is important to keep the power of the audio signal coming from your terminal at maximum level.

SETTING FOR BETTER SOUND QUALITY

There are three main settings.

To access the general settings menu, press **SETTINGS** twice on your remote control. Once in the GENERAL SETTINGS menu, follow the instructions below:

- A. In the menu on the left, select AUDIO: DIGITAL OUT using the **↑** and **↓** arrows. Go to the right and select:
 - HDMI, if you want to use your HDMI cable as your Audio and Video output
 - DOLBY DIGITAL, if you prefer to use a digital output (other than HDMI)
 - OTHER, if you choose to use an analog audio output.Press **△** to confirm your selection.
- B. In the menu on the left, select AUDIO: RANGE using the **↑** and **↓** arrows. Go to the right and, using the arrows again, select NARROW. Press **△** to confirm your selection.
- C. In the menu on the left, select AUDIO: VOLUME CTRL using the **↑** and **↓** arrows. Go to the right and, using the arrows again, select FIXED. Press **△** to confirm your selection.

Naturally, for impeccable sound quality, your TV or home theatre speakers have to be in good condition. Also, be sure to use top-quality speaker wires. In addition, if your home theatre has an AC-3 input, we recommend you use it because the terminal is AC-3 enabled. If you are watching a program in this format, you will get superior quality sound, provided your equipment has been set accordingly.

PAY-PER-VIEW

Indigo and **Viewer's Choice** feature uninterrupted films and special events that can be ordered at any time using the IPG. Charges for these programs will appear on your next month's bill.

- Channel 300 is the preview channel for **Indigo**, and 350, for **Viewer's Choice**. Watch these channels for an overview of current and upcoming films.

HOW TO ORDER A FILM OR EVENT

- Press **GUIDE** and browse through the 300 series channels, or 350 for HD, to see the featured titles. Highlight the title that interests you, press **SELECT** and follow the on-screen instructions.
or
- Tune in to the channel broadcasting the film and follow the on-screen instructions.

HOW TO CANCEL A FILM OR EVENT

- Press **SETTINGS** twice to call up the **General Settings** screen. Select PPV: Purchases. Press **SELECT** and enter your **PIN**. Choose the film or event you wish to cancel. Press **SELECT** to cancel, then **△** to confirm cancellation.

PPV PIN: To order a film or event, you must enter a PIN. The default PIN is 0000. We recommend that you change your PIN upon placing your first order. To do so, you need only enter a new 4-digit PIN when the PIN window appears on-screen.

If you forgot your PIN, contact Customer Technical Support (see page 34).

PARENTAL CONTROL

Parental control is accessed through the Pay-per-View feature (TALC). Consult the relevant section on page 16 for further details.

PERSONAL VIDEO RECORDER

To use the personal video recorder (PVR) function, you must have a terminal with a hard drive and a record function connected to the TV from which you want to record or program your recording.

When you press one of these keys, a status bar is momentarily displayed at the bottom of the screen to show you the progress of playback and broadcast of the program you are watching.

Red/Green division indicates the time you tuned in to the channel

Red, indicates the missed portion of the program

Pause status bar

Title of program



Triangle indicates your current position in the program

Green area indicates stored programming

Clear area indicates portion of program not yet broadcast

Actual time slot of program

Note: The program stored in the memory buffer is erased as soon as you change channels or switch off the PVR. To save a program, you have to record it and save it on the hard drive.

PERSONAL VIDEO RECORDER

LIVE TV CONTROL: HOW TO CONTROL A LIVE PROGRAM

The **PVR** stores the programming being broadcast on the channel you are watching in a memory buffer. This lets you pause and rewind the action (even with a live broadcast), and resume watching the program in real time.



Pauses the program you are watching for a maximum of one hour. After one hour, playback resumes from the point where you paused the program.



Resumes playback of a paused program.



Rewind: press once, twice, three or four times to slow down or speed up the rewind speed.



Fast-forward: press once, twice, three or four times to slow down or speed up the fast-forward speed.



Returns you to live programming.



Instantly replays the last 8 seconds of the program you are watching.



Skips the program or movie you are watching 30 seconds forward (for future use).

Make sure the CBL mode key is activated, because it controls the PVR features.

To see whether the key is activated or not, press the INFO key: if the CBL key's LED lights up, that means the key is activated. If it doesn't, press the CBL key.

HOW TO RECORD AND STORE A PROGRAM

There are three ways to record a program:

- Record a program while you watch it
- Record a program from the Program Guide
- Manually record all programs in a single time slot

RECORD A PROGRAM WHILE WATCHING IT

If you have been tuned in to a program since it started, you can press the  key at any time during the broadcast and the entire program will be recorded.

1. Press .
2. When the **Confirm Recording** screen is displayed, press the  key to record and store the program.
The **RECORD** indicator on the front panel lights up for a few seconds after you confirm the recording.



To record more than one episode of a program and modify the save time, press the  key rather than the **SELECT** key.

If you are watching television and recording two programs at the same time, you must be either tuned in to one of the programs you are recording, or watching a program you have already recorded.

PERSONAL VIDEO RECORDER

RECORD A PROGRAM FROM THE PROGRAM GUIDE



With this type of recording, you decide in advance what programs to record, so you'll never miss them.

1. Press the **GUIDE** key; the title of the program in progress is highlighted.
2. Highlight a program title and press .
3. Press the  key to confirm recording. The title of the recorded program is highlighted in red in the program guide.
4. Press the **GUIDE** again to return to the program in progress.

You can record programs blocked by the Parental Control feature, but you will need to enter your PIN first to watch them.

MANUALLY RECORD ALL PROGRAMS IN A SINGLE TIME SLOT

To manually record all programs in a specific time slot:

1. Press the  key, then press  **Preferences**.
2. Highlight **Schedule a New Manual Recording**, then press **SELECT**.
3. Highlight the channel, the recording start and end times, and the save time, then press .
4. Press **EXIT** to return to the program in progress.

RECORDING OPTIONS

The recording options let you:

- Schedule, in a single step, recording of all episodes of your favourite program.
- Change the default save time.
- Modify the recording start and end times.

CHANGE START AND END TIMES

1. Select hour using **↑** or **↓**, then select minutes using **→**.
2. Do the same for each column.
3. To confirm your settings, press **△**.

If you would rather enter the time manually, you must enter the four digits requested, even if you are only changing the minutes value, otherwise the change will not be programmed.



PLAY BACK A RECORDED PROGRAM

1. Press the **LIST** key, highlight a program title, and press **SELECT**.
2. Highlight an option and press **SELECT**.
3. To return to a program in progress without watching a recorded program in its entirety, press **⏪**, then **EXIT**, and tune in to the desired channel.
4. To return to a program in progress after watching a recorded program in its entirety, press **EXIT** and tune in to the desired channel.

If you stop watching a recorded program to watch a live program, when you return to the recorded program, it will resume playing where you left off. If you want to watch it again from the beginning, press **⏪**, select **Play from beginning** and press **SELECT**.

PERSONAL VIDEO RECORDER

BLOCK A PROGRAM

If you have recorded a program that was not subject to Parental Control, but decide to block access to it later:

1. Press the **LIST** key, highlight a program title, and press **SELECT**.
2. Highlight **Block** and press **SELECT**.
3. Enter your parental PIN and press **△**; a small red padlock appears in the upper left window of the screen, confirming that the title has been blocked.
4. To view the program, you must enter your parental PIN.

SORT PROGRAM TITLES

To make it easier to access recorded programs, you can sort them by alphabetical order or by date and time recorded. To change from one setting to the other:

1. Press the **LIST** key, then press **B Preferences**.
2. Choose the desired sorting method and press **SELECT**.

SAVE TIME

DEFAULT SAVE TIME

1. Press the **LIST** key, then press **B Preferences**.
2. Highlight **Change Save Time** and press **SELECT**.

The save time is the period during which a recorded program will be stored on the terminal's hard drive. period has expired, the program will be erased automatically.

CHANGE THE SAVE TIME FOR A PROGRAM YOU HAVE ALREADY RECORDED

1. Press the **LIST** key, highlight a program title, and press **SELECT**.
2. Highlight **Change Save Time**, and press **△**.
3. Highlight a time and press **SELECT**.
4. Press the **EXIT** key to return to the program in progress.

CHANGE THE SAVE TIME FOR A SCHEDULED RECORDING

1. Press the **LIST** key followed by **△**, then highlight a program title, and press **SELECT**.
2. Highlight the **SAVE** column, select a period, and press **SELECT**.
3. Press the **EXIT** key to return to the program in progress.

HOW TO DELETE A RECORDED PROGRAM OR A SCHEDULED RECORDING

DELETE A PROGRAM FROM THE LIST OF RECORDED PROGRAMS

1. Press the **LIST** key, highlight a program title, and press **SELECT**.
2. Highlight **Erase**, then press **△** to confirm.

DELETE OR MODIFY A SCHEDULED RECORDING

1. Press the **LIST** key, then press **△**.
2. Highlight a program title and press **SELECT**.
3. Press **B** to delete the program, then press **△** to confirm.
or
Modify program, then press **△**.

DELETE A RECORDING IN PROGRESS

1. Tune in to the channel broadcasting the program being recorded and press the **□** key.
2. Highlight **Stop and Erase**, then press **SELECT**.

PICTURE-IN-PICTURE (PIP) – HOW TO WATCH TWO PROGRAMS AT ONCE

The keys near the bottom of the remote control are used to control the PIP feature, which lets you view two programs at the same time.

- Press **PIP** ; a second screen (the PIP screen) appears superimposed on the main screen.
- Press **CH+** / **CH-** to change the channel in the PIP screen.
- Press **Swap** to swap the program in the PIP screen to the main screen, and vice versa.
- Press **Move** to move the PIP screen to a different corner of the main screen.

RECORDING CAPACITY

Digital TV channels broadcast variable amounts of data, depending on the type of program being aired. For instance, there may be times when a sports specialty channel broadcasts a larger quantity of data than channels whose lineups are primarily made up of talk shows or soap operas. Sports programs generally involve much more movement, and more data are therefore required to reproduce the images on your screen. The number of recording hours available to you therefore varies according to the types of programs you record.

HDTV (high-definition television) channels need to transmit 2 to 2.5 times more data than standard channels to reproduce a higher quality image on your screen. Your PVR HD is equipped with a high-capacity hard drive (500 gigabytes) that lets you record up to 55 hours of high-definition content, or up to 280 hours of standard-definition content.

QUICK SETTINGS

The **Quick Settings** screen displays the most frequently used functions and settings:

- Add a channel to (or remove it from) your Favourites list
- Turn Parental Control ON/OFF
- Start recording
- Set Sleep Timer
- Set SAP (Second Audio Program) language
- Switch Caption OFF/ON or ON with mute
- Block or unblock the current channel
- Set Picture Size

HOW TO DISPLAY QUICK SETTINGS

1. Press the **SETTINGS** key once to display the **Quick Settings** screen, highlight an option, and press **SELECT** to modify it.
2. Press the **EXIT** key to leave **Quick Settings** and return to the current channel.

For more information on the options available in Quick Settings, press the **SETTINGS** key twice to display the General Settings screen, highlight an option, and press the **INFO** key.

GENERAL SETTINGS

The General Settings screen lets you customize the terminal's display features and set the timers.

- Press the **SETTINGS** key twice, highlight an option, and press the **INFO** key to see what the option does.

Options
 Audio: Digital Out
 Audio: Range
 Audio: Volume Ctrl
 Block: Channels
 Block: PIN
 Block: Rating
 Block: Time New
 CC: Background
 CC: Characters
 CC: Options
 CC: Source
 Display: Power Off
 Display: Power On
 Language: Audio
 Language: Keyboard

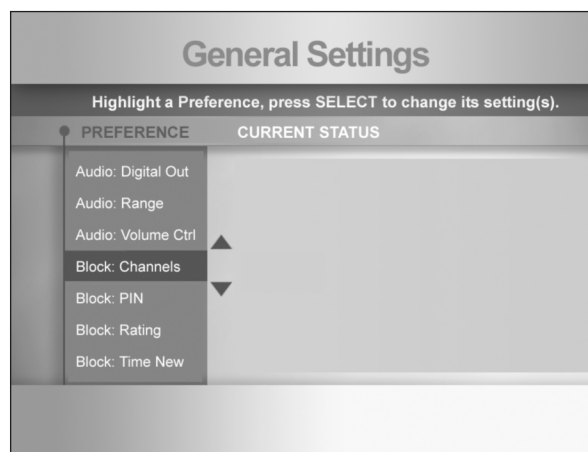

Options
 Language: Screen
 Purchase: PIN PPV: Purchases
 Set: A-C Outlet
 Set: Color Scheme
 Set: Output Chan
 Set: VCR Commander
 Timer: All
 Timer: Rewind New
 Timer: Sleep
 Timer: Turn Off
 Timer: VCR New
 Timer: Wake-Up
 Viewer: Favourites
 Viewer: Power On

FREQUENTLY ASKED QUESTIONS

TERMINAL

My terminal feels hot, is this normal?

Yes, because the electronic components inside generate a lot of heat. To prevent overheating, avoid blocking the air vents on the top and sides and do not place the terminal in enclosed furniture.

Can I leave my terminal on all the time?

Yes, but we recommend turning it off after use.

FUNCTIONS

Does the terminal support the Second Audio Program (SAP) function?

Yes. The terminal can convert SAP even though very few programs are designed to support this function.

Does the terminal show support closed-captioned programs?

Yes, if a closed-captioning decoder is connected to the TV. The terminal relays the information but does not decode it.

PERIPHERALS

Can I use a DVD player or DVD recorder with the terminal?

Yes, because the two devices work independently of each other.

Is the VCR+ function on the VCR of any use with the terminal?

No, this function is only used to record the analog signal.

What connects to the USB port and what is it for?

USB is a computer standard. The port is used to connect peripheral devices: keyboard, mouse, scanner, printer, diskette storage drive. At this time, the USB port on the terminal is not operational but it will be in the near future.

REMOTE CONTROL

Can I turn on my TV and the terminal at the same time?

Yes, but if your TV is an older model, you will have to:

- Connect the TV to the CA output on the back of the terminal.
- Press the SETTINGS button twice on the terminal's keyboard or remote control.
- Select Settings: CA output and press SELECT.
- Select "Avec le terminal" (with the terminal), press SELECT and SETTINGS.

SOUND AND IMAGE

Poor picture reception

In most cases, simply re-initializing the terminal re-establishes the service. To re-initialize, you need to turn off the terminal, disconnect it from the wall outlet, and then reconnect it. Wait 5 minutes, restart the terminal and tune in to a channel. If the problem persists, please contact Technical Support.

What gets connected to the S-VIDEO output and what is it for?

It is used to connect a VCR or TV equipped with an S-VIDEO input. This connector separates colours and brightness, which enhances image quality. You need to purchase a cable in order to use it.

Can I take advantage of AC-3 technology with the terminal?

Yes, but you need an AC-3 decoder. This decoder is usually built into newer, sound systems or home theatre systems. The terminal relays the information (Digital Audio Out connector) but does not decode it.

SURVEILLANCE CAMERA

In analog mode, I used to have access to my building's surveillance camera. Is this still possible?

Yes, but you will have to use a splitter in your connection to access the analog signal and tune in to channel 950.

FREQUENTLY ASKED QUESTIONS

FRONT PANEL DISPLAY

Can I change the time shown on the front of the terminal?

No, the time shown reflects the terminal's internal clock. However, depending on the screen language setting, it can be displayed in the 24-hour system (French) or the 12-hour system (English).

Modifying the time format displayed on the front of the terminal

- Press the SETTINGS button twice on the remote control or wireless keyboard.
- Select Language: Screen and press SELECT.
- Select English or Spanish for the 12-hour format and French for the 24-hour format, and then press SELECT and SETTINGS.

PAY-PER-VIEW AND PIN

I ordered an Indigo movie and the terminal asked me to enter a 4-digit PIN. What is it for?

This PIN is a security feature. Only individuals who know the PIN can order a movie or an event. All subscribers have the default PIN 0000; it is a good idea to change the PIN regularly.

Ordering a movie with Viewer's Choice

1. Tune in to Channel 350 (VCC trailers) and press Guide on the keyboard or remote control.
2. Select a time slot and scroll the movies broadcast during this period.
3. Select a title and press SELECT twice.
4. Press B and enter your PIN. The default PIN is 0000.

Note: You can order movies up to 4 hours in advance and events up to 7 days in advance.

Forgot your PIN?

If you have never changed your PIN, enter 0000, which is the default PIN. If you have already changed it, you will have to contact Customer Service.

The telephone numbers for **Customer Service** and **Customer Technical Support** are listed on page 34.

REMOTE CONTROL SETUP CODES

TV

- Acer – 454, 782
 Admiral – 026, 027, 028, 029, 054, 211, 213, 408
 Advent – 047, 072, 094, 425, 447, 463
 Aventura – 047
 Aiko – 015, 051, 391
 Aiwa – 214, 417
 Akai – 020, 053, 462, 473, 522, 524, 547, 572, 586
 Alleron – 211, 395
 Amark – 023, 215
 Amstrad – 157
 Amtron – 168, 400
 Anam – 044, 168, 217, 218, 219, 220, 221, 222, 223, 400, 403
 AOC – 053, 073, 108, 384, 573, 587
 Apex – 030, 038, 427, 599,
 Astar – 462
 Audiovox – 168, 191, 220, 400, 465, 659
 Belcor – 073
 Bell & Howell – 211, 213, 355, 388, 736
 Ben Q – 454, 820
 Bradford – 168, 400
 Brilliant – 792
 Broksonic – 165, 167, 423, 434, 809
 Brokwood – 073
 Candle – 068, 073, 091, 108, 385, 573, 587
 Carver – 072, 405, 729
 Celebrity – 020
 Centurion - 095, 107, 108
 Citizen – 015, 023, 051, 068, 073, 091, 108, 168, 211, 213, 233, 355, 385, 388, 391, 400, 573, 587, 741
 Coby – 558
 Colortyme – 730
 Concerto – 073, 095, 108, 573, 587
 Contec/Cony – 039, 147, 168, 233, 400, 732
 Coronado – 023
 Craig – 168, 217, 218, 220, 223, 400, 786
 Crosley – 072, 405, 598, 729
 Crown – 023
 Curtis Mathes – 016, 023, 031, 054, 072, 073, 107, 108, 211, 213, 355, 388, 405, 573, 587, 606, 729, 735, 741, 759, 777
 CXC – 168, 400
 Daewoo – 051, 068, 073, 095, 158, 159, 189, 191, 194, 196, 197, 198, 200, 202, 204, 205, 206, 207, 209, 737, 741, 793
 Daytek – 583, 833, 834
 Daytron – 023, 073, 095, 107, 108, 573, 587, 741
 Dimensia – 759
 Dell – 072, 094
 Diamond Vision – 563
 Dumont – 049, 073, 108, 573, 587
 Duraband – 157
 Dynex – 167, 415, 424, 567, 577
 Electroband – 020
 Electrohome – 020, 044, 073, 095, 108, 403, 573, 587, 739
 Elektra – 353
 Element – 459, 587
 Emerson – 016, 021, 023, 031, 053, 064, 073, 100, 103, 108, 139, 158, 159, 164, 165, 166, 167, 168, 169, 189, 191, 211, 233, 355, 387, 392, 395, 400, 401, 402, 403, 408, 415, 424, 456, 507, 567, 573, 577, 590, 587, 731, 734, 736, 741, 743, 744, 745, 746, 748, 750, 751, 754, 757, 760, 761, 764, 786
 Envision – 073, 095, 108, 573, 587
 ESA – 454, 456, 538
 Fisher – 104, 355, 356, 388, 736
 Fijitsu – 211, 395, 460, 469, 560, 779, 813
 Funai – 047, 048, 157, 168, 211, 395, 400
 Futurtech – 168, 400
 Getaway – 426, 533
 GE – 015, 018, 042, 044, 045, 049, 054, 055, 068, 069, 070, 073, 090, 092, 095, 101, 102, 103, 108, 211, 213, 389, 390, 396, 397, 403, 406, 407, 573, 587, 739, 742, 755, 759, 806
 Gibraltar – 023, 048, 049, 053, 068, 073, 090, 095, 107, 108, 233, 360, 361, 573, 587
 Go Video – 443, 562
 Goldstar – 023, 053, 068, 073, 090, 107, 108, 233, 360, 361, 424, 567, 577, 587, 823, 825
 Gradiente – 104
 Grundig – 233
 Grunpy – 023, 047, 073, 095, 108, 233, 360, 361, 384, 573, 587
 Haier – 020, 053, 073, 095, 108, 427, 519, 573, 587, 596
 Hallmark – 073, 095, 108, 573, 587
 Harvard – 168, 400
 Hi-Sense – 072
 Hitachi – 023, 039, 068, 073, 095, 096, 097, 098, 099, 100, 108, 233, 393, 573, 587, 732, 750, 753, 756, 787, 796, 801, 803, 808, 814, 815, 817, 819, 821
 HP – 072
 Hyundai – 453
 iLO – 458, 524, 577, 586, 602
 IMA – 168, 400
 Infinity – 072, 406, 729
 Initial – 470
 Inkal – 364
 Insignia – 167, 415, 424, 450, 456, 461, 462, 523, 524, 567, 577, 586
 JBL – 072, 405, 729
 JC Penney – 023, 038, 039, 045, 053, 068, 073, 091, 092, 095, 102, 108, 355, 631, 384, 385, 389, 390, 573, 587, 739, 741, 742, 755, 759, 767, 795
 JCH – 020
 Jensen – 062, 073, 108, 461, 573, 587
 JVC – 039, 045, 104, 105, 106, 233, 396, 397, 410, 589, 728, 732, 742, 753, 763, 766
 Kawasho – 020, 073, 095, 108, 573, 587
 Kenwood – 073, 095, 108, 573, 587
 Kloss Novabeam – 071, 168, 400, 404
 KMC – 023
 Konka – 065, 445, 589
 Kosch – 462
 KTV – 023, 053, 064, 168, 233, 366, 400, 741, 770
 Kurazai – 211, 213
 Legend – 169
 LG – 023, 053, 068, 073, 090, 107, 108, 233, 360, 361, 384, 424, 567, 577, 587
 Lodgenet – 211, 213
 Logik – 211, 213
 Luxman – 068, 073, 095, 108, 573, 587
 LXI – 024, 026, 027, 028, 029, 038, 055, 069, 070, 072, 157, 355, 388, 405, 725, 729, 736, 755, 759, 773
 MAG – 459
 Magnavox – 023, 044, 068, 071, 072, 073, 089, 090, 091, 092, 093, 094, 095, 108, 134, 233, 385, 387, 390, 397, 398, 403, 404, 405, 419, 423, 426, 456, 463, 470, 472, 523, 533, 549, 594, 595, 729, 740, 783, 810
 Majestic – 211, 213
 Marantz – 053, 072, 073, 097, 098, 107, 108, 109, 405, 573, 587, 729, 778
 Matsui – 582, 583, 585
 Maxent – 428, 533, 534
 McIntosh - 555
 Megatron – 215
 Memorex – 090, 211, 213, 355, 384, 388, 405, 423, 459, 736
 MGA – 053, 068, 073, 090, 095, 104, 107, 108, 109, 110, 216, 384, 394, 394, 398, 399, 417, 573, 587, 739, 790
 Mitsubishi – 053, 068, 073, 090, 095, 104, 107, 108, 109, 110, 216, 384, 394, 395, 398, 399, 417, 573, 587, 739, 790
 Midland – 023, 045, 049, 396, 741, 742, 755
 Mintek – 470
 Montgomery Ward – 022, 023, 026, 027, 028, 029, 053, 071, 072, 108, 211, 213
 Motorola – 026, 027, 028, 029, 044, 403
 MTC – 073, 108, 384, 573, 587
 Multitech – 168, 400
 Multivision – 738
 NAD – 023, 773, 787
 NEC – 028, 029, 044, 068, 073, 090, 108, 200, 384, 403, 464, 573, 587, 730
 NetTV – 426, 822
 Nikko – 015, 051, 391
 Nordcent – 455, 472
 NuVision – 831, 832
 NTC – 015, 051, 391
 Olevia – 073, 108, 519, 541, 587
 Onwa – 168, 400
 Optimus – 787
 Optonica – 022, 026, 027, 028, 029
 Orion – 019, 159, 160, 161, 162, 163, 382, 423, 424, 558, 577
 Panasonic – 042, 043, 044, 045, 046, 403, 419, 423, 429, 631, 742, 771, 829
 Philco – 023, 044, 053, 068, 071, 072, 073, 091, 093, 095, 108, 233, 384, 385, 403, 404, 405, 463, 573, 587, 729
 Philips – 023, 044, 068, 071, 072, 073, 089, 090, 091, 092, 093, 094, 095, 108, 134, 233, 385, 387, 390, 397, 398, 403, 404, 405, 419, 423, 426, 456, 463, 470, 472, 523, 533, 549, 594, 595, 729, 740, 783, 810
 Pilot – 023, 073, 094, 108, 233, 573, 587, 741
 Pioneer – 019, 073, 100, 108, 111, 144, 383, 551, 573, 587, 597, 747, 750, 780, 785, 787, 789, 826
 Planar – 474
 Plasmasync – 778
 Polaroid – 384, 394, 459, 465, 805, 811
 Portland – 015, 023, 051, 068, 073, 108, 384, 391, 573, 587, 741
 Prima – 072, 837
 Prism – 045, 742
 Proscan – 055, 070, 073, 726, 755, 759
 Proton – 073, 090, 108, 233, 371, 372, 467, 573, 587, 749
 Protron – 457, 467
 Proview – 459
 Pulsar – 049, 073, 108, 573, 587
 Quasar – 043, 044, 045, 046, 403, 742, 752, 770, 771

LIST OF CODES

- Radio Shack – 022, 023, 046, 069, 073, 108, 168, 233, 355, 388, 400, 573, 587, 736, 741, 759
- RCA – 042, 044, 052, 053, 054, 055, 068, 069, 070, 073, 095, 100, 108, 191, 384, 403, 408, 416, 573, 587, 631, 725, 750, 755, 758, 759, 762, 765, 768, 769, 791
- Realistic – 022, 023, 046, 069, 166, 168, 233, 355, 388, 400, 736, 741, 759
- Runco – 049, 525
- Sampo – 023, 073, 090, 108, 426, 533, 573, 587, 741, 818
- Samsung – 015, 016, 017, 023, 031, 073, 090, 095, 107, 108, 134, 147, 151, 153, 233, 384, 386, 411, 426, 508, 533, 573, 577, 587, 741, 757, 772, 788, 794, 800, 802
- Sansui – 169, 392, 415, 423, 424, 812
- Sanyo – 073, 104, 108, 353, 355, 356, 376, 377, 378, 388, 573, 587, 735, 736, 775
- Sceptre – 468
- Scott – 073, 090, 108, 168, 211, 233, 395, 400, 561, 573, 587, 743
- Sears – 023, 029, 030, 031, 038, 039, 068, 072, 095, 104, 157, 211, 213, 353, 355, 356, 388, 395, 405, 573, 729, 732, 738, 755, 759, 763, 773, 792
- Sharp – 016, 022, 023, 024, 025, 026, 027, 028, 029, 073, 108, 233, 393, 395, 409, 573, 587, 741, 745, 751, 779, 797
- Shogun – 073, 108, 573, 587
- Signature – 023, 026, 027, 028, 029, 108, 211, 213
- Simpson – 091, 385
- Sony – 014, 020, 021, 050, 095, 178, 540, 774, 804, 824, 827, 828, 830
- Soundesign – 073, 091, 108, 168, 211, 385, 395, 400, 573, 587, 601
- Soyo – 562, 601
- Squareview – 157
- SSS – 073, 108, 168, 400, 573, 587
- Starlite – 168, 400
- Sunbrite TV – 587
- Superscan – 419, 423
- Supre-Macy – 380
- Suprema – 020
- SVA – 592
- Sylvania – 047, 068, 071, 072, 073, 090, 091, 092, 093, 095, 107, 108, 157, 158, 385, 404, 405, 419, 423, 456, 466, 507, 573, 587, 590, 595, 729, 823
- Symphonic – 047, 157, 168, 400, 456, 595, 761
- Tandy – 026, 027, 028, 029
- Tatung – 044, 403, 446
- Technics – 045, 742
- Techwood – 045, 068, 073, 573, 742
- Teknika – 023, 068, 072, 091, 108, 168, 213, 463, 587, 729, 732, 741
- Telerent – 023, 213
- Tera – 381
- Tevion – 065, 414
- Thomson – 608, 798
- TMK – 068, 073, 090, 108, 573, 587
- Toshiba – 022, 030, 031, 038, 039, 092, 355, 388, 423, 571, 736, 755, 773, 778, 781, 799, 807
- Totevision – 233, 741
- Trutech – 095, 408
- Universal – 068, 102, 389, 390
- Venturer – 073
- Victor – 106, 763
- Vidikron – 072, 105, 729
- Vidtech – 068, 073, 108, 384, 573, 587
- ViewSonic – 426, 428, 455, 468, 472, 513, 515, 527, 528, 529, 530, 531, 532, 533, 534, 535, 536, 537, 538, 539, 729, 816
- Viore – 031, 599, 601, 602, 837, 840
- Visco – 589
- Vision Quest – 459, 729
- Vizio – 053, 062, 073, 095, 108, 454, 538, 561, 573
- Wards – 022, 068, 071, 072, 073, 090, 091, 093, 095, 102, 108, 211, 213, 384, 385, 389, 390, 395, 404, 405, 573, 587, 729, 743, 759, 761, 784
- Westinghouse – 020, 458, 463
- White Westinghouse – 191, 211, 408, 449
- XR-1000 – 213
- Yamaha – 068, 073, 108, 384, 573, 587
- York – 090, 108
- Zenith – 047, 048, 049, 050, 051, 073, 095, 097, 108, 191, 213, 391, 405, 406, 408, 434, 567, 573, 577, 587
- Admiral – 066, 075, 453, 458
- Aiwa – 132
- Akai – 058, 269, 275, 336, 351, 352, 354
- Audio Dynamics – 243, 291
- Bell & Howell – 238, 357
- Brocksonic – 132, 329, 333, 337, 339, 358, 359, 434
- Canon – 086, 170, 362
- Citizen – 033, 172, 247, 331, 429, 491
- Colortyme – 291
- Craig – 172, 331, 363
- Curtis Mathes – 066, 086, 112, 172, 174, 247, 291, 472
- Daewoo – 033, 342, 343, 344, 345, 346, 347, 429, 491
- Daytron – 345, 365
- DBX – 243, 291
- DELL – 263
- Dynatech – 132
- Emerson – 033, 086, 132, 258, 326, 327, 329, 331, 332, 333, 334, 335, 336, 337, 338, 339, 340, 341, 352, 472
- Fisher – 035, 081, 238, 357, 363, 434, 467, 496
- Funai – 132
- GE – 066, 086, 170, 172, 174, 472
- Go Video – 172, 348, 349, 350
- Goldstar – 247, 291, 331
- Hitachi – 078, 132, 462
- Instant Replay – 086, 472
- JC Penney – 078, 086, 132, 172, 238, 291, 329, 331, 462, 472
- JCL – 086, 472
- JVC – 120, 128, 238, 243, 247, 250, 253, 291, 486
- Kenwood – 120, 128, 132, 238, 243, 247, 291, 486
- LG – 247, 291, 331
- Lloyd – 132
- Logik – 367
- LXI – 132, 331
- Magnavox – 086, 132, 183, 247, 472, 552
- Marantz – 086, 172, 183, 238, 247, 291, 472
- Marta – 331
- Matsui – 368
- Memorex – 086, 132, 172, 238, 326, 331, 363, 369, 370, 604
- Mitsubishi – 078, 120, 128, 255, 258
- Montgomery Ward – 066, 170, 173, 373
- MTC – 132, 172
- Multitech – 132, 172, 367
- NEC – 120, 128, 238, 243, 247, 269, 291, 374, 375, 486
- ON – 291
- Orion – 322, 326, 327, 328, 329, 330, 604
- Panasonic – 086, 112, 117, 430, 472, 477, 482
- Pentax – 078, 462
- Philco – 086, 132, 183, 552
- Philips – 086, 132, 183, 247, 472, 552
- Pioneer – 078, 120, 128, 263, 462, 486
- Portland – 345
- Proscan – 066, 170, 174
- Quartz – 238, 378
- Quasar – 112, 086, 477
- Radio Shack – 066, 081, 086, 172, 238, 331, 363
- RCA – 066, 078, 086, 141, 170, 172, 173, 174, 352, 462, 472
- Realistic – 033, 066, 081, 086, 132, 238, 331, 363, 453
- Samsung – 033, 172, 269, 271, 275, 276, 278, 510
- Sansui – 120, 128, 326, 367, 379, 486, 604
- Sanyo – 172, 238, 346, 357, 363
- Scott – 033, 132, 258, 329, 332, 367, 429, 491
- Sears – 035, 066, 078, 081, 086, 238, 331, 363, 434, 462, 496
- Sharp – 066, 075, 453, 458
- Shintom – 058, 078, 367
- Signature – 066, 170, 173, 373
- Sony – 056, 058, 060, 439, 443, 448, 501, 505, 553
- Soundesign – 132
- Sylvania – 086, 132, 141, 183, 258, 322, 324, 420, 472
- Symphonic – 132
- Tandy – 132, 238
- Tashiko – 331
- Tatung – 243
- Teac – 132, 243
- Technics – 086, 331, 472
- Teknika – 086, 132, 331, 359
- Thomas – 132
- TMK – 172, 338
- Toshiba – 033, 035, 078, 081, 258, 429, 434, 462, 467, 491, 496, 604
- Totevision – 172, 331
- Unitech – 172
- Vector Research – 033, 291
- Video Concepts – 033, 132, 291
- Wards – 033, 066, 078, 086, 132, 172, 247, 331, 363, 453
- XR-367
- Yamaha – 132, 238, 243, 247, 291
- Zenith – 058, 120, 122, 128, 132, 435, 486

LIST OF CODES

AUDIO

- ADC – 318
Adcom – 325
Aiwa – 176, 301, 518, 521, 633, 634, 668, 669, 671
Akai – 142, 249, 261
Bose – 302, 440, 644, 672
Carver – 155, 176, 180, 518, 668, 669
Crown – 154
Daewoo – 501
Denon – 262, 273, 307, 660, 661, 703, 704, 715
Emerson – 673
Everquest – 136
Fisher – 063, 180, 230, 274
Fostgate Audioionics – 305
GE – 674
Goldstar (LG) – 036, 308
Harman Kardon – 130, 257, 305, 306, 315, 669, 716
Hitachi – 240, 690
Jensen – 140, 517, 520, 666, 667,
JVC – 114, 241, 297, 691
Kenwood – 063, 131, 137, 176, 274, 277, 282, 289, 299, 309, 444, 692
Koss – 717, 718
Krol – 176
LG (Goldstar) – 036, 308
Linn – 518, 668, 669
Luxman – 281
Magnavox (Philips) – 037, 080, 084, 119, 184, 296, 433, 502, 503, 504, 518, 668, 669, 670
Marantz – 282, 283, 284, 285, 516, 517, 518, 520, 666, 668, 669, 670
McIntosh – 557
Mission – 176
Mistubishi – 245, 249, 664, 693
NAD – 182, 231, 286, 290
Nakamichi – 264, 319, 694
NEC – 235, 695
NSM – 176
Onkyo – 126, 171, 300, 304, 543, 579, 662, 663, 696
Optimus – 142, 229, 321
Panasonic – 032, 074, 184, 266, 267, 280, 437, 438, 441, 512, 638, 639, 640, 641, 642, 643
Parasound – 323, 632
Philips (Magnavox) – 037, 080, 084, 119, 184, 296, 433, 502, 503, 504, 518, 668, 669, 670, 718
Pioneer – 116, 123, 127, 137, 251, 298, 309, 697, 719
Quasar – 032, 184
Radio Shack – 186, 190, 229, 266, 267, 279, 289
RCA – 037, 119, 137, 295, 309, 439, 698
Realistic – 226, 268
Rotel – 310, 700
SAE – 176
Samsung – 492, 546, 841
Samsui – 283, 518, 668, 669
Sanyo – 137, 190, 195, 230, 309
Scientific Atlanta – 312
Scott – 186, 272
Sears – 699
Sharp – 288, 289, 294
Sherwood – 229, 267, 505, 506, 700
Sony – 041, 057, 067, 232, 287, 292, 293, 442, 610, 611, 612, 635, 636, 720, 835, 836
Soundesign – 083, 148, 239, 242, 265, 311, 320
SSI – 313
STS – 318
Sylvania – 084
Taekwang – 142
Teac – 186, 314, 316, 701
Technics – 032, 184, 208, 317, 512, 643
Toshiba – 290, 682
Victor – 114, 241
Wards – 063, 114, 241, 518, 669
Yamaha – 145, 254, 280, 303, 521, 542, 579, 630, 637, 702
Zenith – 036, 083, 088, 148, 239, 265

DVD

- Aiwa – 495, 617, 618, 685
Akai – 548, 584, 588
Alpine – 621
Apex – 227, 609, 621, 657, 683
Apex Digital – 193, 227, 489, 681
Audiovox – 659
Axiom – 491
B144 – 146
BOSE – 651
Clarion – 622
Classic – 623
Coby – 688
Curtis – 842
CyberHome – 490, 496, 498
Daewoo – 494, 624
Denon – 124, 201, 203, 448, 570, 625, 626, 686
Diamond Vision – 566
DirecTV – 708
Dish Network – 711
Dish Network System – 709
Dishpro – 709
DVD-Video – 199, 484, 488
Dyne – 482
ECA – 156
Echostar – 709, 711
Emerson – 129, 135, 482, 483, 486, 526, 568, 569, 591, 605, 724
Expressvu – 709
GE – 150, 152, 156, 175, 511
GPX – 627
GOI – 709
Go Video – 129, 486, 652
Goldstar (LG) – 129, 133, 135, 179, 260, 568, 569
Gradiente – 212, 234, 581, 614
Harmon Kardon – 256, 259
Haier – 600
Hitachi – 149, 212
HTS – 709
Hughes Network System – 708
Humax – 708
iLo – 588
Insignia – 482, 588, 665
JVC – 177, 179, 475, 476, 477, 478, 653, 709, 711
Kenwood – 228, 628, 677
KLH – 248, 252
Konka – 619, 620, 628
Koss – 234, 581, 614
Lasonic – 152, 156, 656, 678
LiteOn – 499, 500
LG (Goldstar) – 129, 133, 135, 179, 260, 568, 569
Magnavox – 138, 143, 146, 234, 270, 484, 550, 564, 581, 593, 605, 609, 614, 679, 683, 706, 707, 708
Marantz – 270
Matsui – 234, 580, 581, 614
Memorex – 629, 839
Mintek – 432
Mitsubishi – 181, 185, 485
NAD – 129, 135, 246, 483, 486, 568, 569, 650, 724
Nakamichi – 645
Norcent – 514
Onkyo – 085, 244, 687, 689
Orion – 603
Panasonic – 115, 118, 121, 124, 201, 431, 448, 570, 646, 682, 684, 713, 431, 448, 570
Philips – 138, 143, 146, 234, 270, 484, 550, 564, 581, 593, 605, 609, 614, 679, 683, 706, 707, 708
Pioneer – 125, 187, 188, 597, 615, 647, 705
Polaroid – 497
Prima – 838
Proceed – 236
Proscan – 727
Protron – 488
Qwestar – 234, 581, 614, 648
RCA – 152, 156, 658, 678, 708
Replay TV – 422, 710, 713
Samsung – 192, 212, 224, 225, 487, 493, 509, 545, 559, 576, 652
Sanyo – 549, 654
Scientific-Atlanta – 565, 574, 575, 675, 676
Sears – 559
Sharp – 034, 076, 077, 079, 565, 574, 575
Sonic Blue – 713
Sony – 040, 059, 061, 152, 156, 436, 479, 480, 481, 578, 610, 678, 680, 712, 714, 721, 722
Sylvania – 421, 484, 591, 605
Symphonic 484
Techwood – 246, 650
Thomson – 156, 237, 608
Tivo – 418, 706, 708, 712, 721, 722
Toshiba – 082, 085, 087, 113, 544, 607, 609, 616, 655, 683, 687, 723
Viewmage – 511
Yamaha – 121, 124, 201, 210, 448, 570, 679
Yamakawa – 181, 485
Zenith – 129, 133, 135, 483, 724

CUSTOMER SERVICE

CUSTOMER SERVICE

For more information on our packages or to change your subscription, please get in touch with Customer Service. Our agents are available between 7:30 a.m. and 10:00 p.m. Monday through Friday, between 8 a.m. and 6 p.m. on Saturday and Sunday between 9 a.m and 5:30 p.m.

Montréal	514-281-1711
Québec City	418-847-4410
Saguenay	418-545-1114
Outaouais	819-771-7715
Elsewhere in Quebec	1-88-VIDEOTRON

CUSTOMER TECHNICAL SUPPORT

For problems of a technical nature, please contact Customer Technical Support. Our technicians are available 24 hours a day, seven days a week.

Montréal	514-841-2611
Québec City	418-842-2611
Saguenay	418-543-4611
Outaouais	819-771-2611
Elsewhere in Quebec	1-88-VIDEOTRON

Visit our Website: videotron.com

FOR HD CONTENT, TUNE INTO CHANNELS 600 AND UP.

SETUP

Refer to the appropriate section in order to configure your terminal. The settings you choose on your **HD** terminal will directly influence the picture quality you obtain. To configure them, follow the instructions in the Setup Wizard section on the following page.

If you use **DVI or a HDMI** cables to connect your **HD** terminal to your TV, no further configuration is normally required. With this type of connector, the two devices automatically determine the optimal image resolution.

CONNECTORS

Three types of connector are available for **HDTV: HDMI, DVI cable** (on some models only) and **Component input**. You **must** use one of these two connector types to obtain an image when viewing channels broadcast in high definition. They are **recommended** for SD content as well, in order to minimize the number of motion artifacts.

SETUP WIZARD

INTRODUCING THE SETUP WIZARD

WHAT IS THE SETUP WIZARD?

The HDTV Setup Wizard is an on-screen program that helps you set up your high-definition terminal to receive the best picture quality that the HDTV supports.

BEFORE YOU BEGIN

Before you begin to set up your HD terminal, you may want to have available the user's guide that came with your HDTV for reference.

IS IT NECESSARY TO USE THE SETUP WIZARD?

Yes. Whether you have used the component (**Y**, **Pb** and **Pr**), **DVI** or **HDMI** connectors to link your HDTV to the HD terminal, the Setup Wizard will provide your system with the necessary flexibility to ensure that you obtain the best picture quality you can get at all times.

Notes:

- The analog Y, Pb, Pr ports become inactive when the HDTV is connected to the DVI or HDMI port.
- If the HDTV is connected to the DVI or HDMI port on the back of the set-top and you see this alert message on the screen, it means that the HDTV and the set-top are not compatible. If this occurs, reconnect the set-top to the Y, Pb, Pr ports on the set-top.

DVI or HDMI Alert

Your HDTV does not support HDCP.
Please use the YPbPr component connection
to watch TV.

PICTURE FORMATS

WHAT IS THE DIFFERENCE BETWEEN A STANDARD SCREEN AND A WIDE SCREEN?

The type of screen your HDTV has (wide screen or standard screen) determines how the set-top displays programs on the screen. The picture format for an HDTV is a combination of aspect ratio and screen resolution and is different for standard-screen and wide-screen HDTVs.

WHAT IS AN ASPECT RATIO?

An aspect ratio is the ratio of the width to the height of the TV screen. The aspect ratios differ because the television industry manufactures both standard-screen and wide-screen HDTVs to appeal to consumer viewing preferences.

A standard-screen HDTV has a 4:3 aspect ratio. The screen is 4 units wide for every 3 units tall.

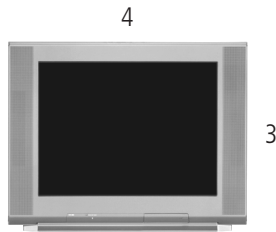

Aspect Ratio: 4:3
Screen Resolution:
 480p or 480i fill the screen

A wide-screen HDTV is one-third wider than a standard-screen HDTV. The screen is 16 units wide for every 9 units tall.

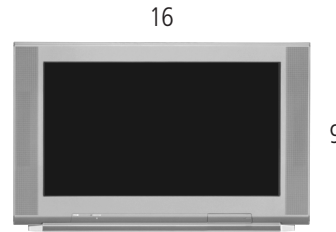

Aspect Ratio: 16:9
Screen Resolution:
 720p or 1080i fill the screen

WHAT IS THE SCREEN RESOLUTION?

The screen resolution indicates the amount of detail that the picture displays. Resolution is identified by the number of display lines on the screen. The techniques that an HDTV uses to “paint” the picture on the screen are referred to as progressive and interlaced.

For example, a resolution of 1080i indicates that the screen shows 1080 lines in an interlaced display, and 480p means that the screen shows 480 lines in a progressive display.

Note: The screen resolution (1080i, 480p, etc.) is sometimes referred to as the scan rate. The terms are interchangeable.



With the **progressive method**, every pixel on the screen is refreshed simultaneously.

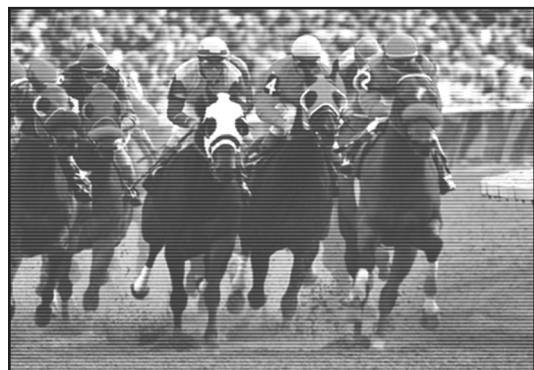

The **interlaced method** involves refreshing pixels in alternation – first the odd lines and then the even lines.

SETUP WIZARD

HOW DO I KNOW WHICH PICTURE FORMAT TO CHOOSE?

The type of screen your HDTV has determines how the set-top displays programs on the screen. The following examples show how programs will look when the picture format is set to **Normal** mode (not Stretch or Zoom modes).

Standard-screen HDTVs

**On a wide-screen HDTV,
these picture formats:**

480p or 480i standard



720p or 1080i wide



Automatically display in this manner:

Full-screen format



Letterbox format



Wide-Screen HDTVs

**On a wide-screen HDTV,
these picture formats:**

480p or 480i standard



720p or 1080i wide



Automatically display in this manner:

Pillarbox format



Full-screen format



SETTING UP YOUR HD TERMINAL WITH THE SETUP WIZARD

BEFORE YOU BEGIN TO SET UP YOUR HD TERMINAL USING THE SETUP WIZARD, THERE ARE TWO THINGS YOU NEED TO DO:

- Download the latest information to the set-top. (You only need to do this for the initial setup. After the initial set up, programming information is downloaded to the set-top automatically on a regular basis.)
- Prepare the set-top to send picture formats that your HDTV supports.

Download the latest programming information to the set-top

Assuming that you have linked your HDTV to the HD terminal using either the component (Y, Pb, Pr), DVI or HDMI connectors, complete the following steps to download latest software, programming, and service information to the set-top. (Be sure you have made a note of which video input port the set-top is connected to on the HDTV. For example: Video input port 6.)

Note: You only need to do this for the initial setup.

1. Plug the set-top and the TV into an AC power source.
2. Do not turn on the set-top or TV yet.
3. Wait until you see one of the following displays on the front of the set-top:
 - Current time
 - Four dashes (----)



Important: If the display shows activity on the set-top, it means that the operating system of the terminal is being updated: this process may take several minutes. When the update is complete, the front panel displays the current time or four dashes (----).

4. **STOP!** Before you turn on the TV or the set-top, you should have read the information in the Picture Formats section, earlier in this guide.

Prepare the set-top to send picture formats that your HDTV supports

If your HDTV displays a black screen when you turn it on, the set-top may be sending a picture format that your HDTV does not support. Prepare the set-top to send all picture formats that your HDTV supports. Later, while watching TV, you will be able to toggle among the different settings to select the format that provides the best picture quality for the program you are watching.

Complete these steps to prepare the set-top to deliver programming in the picture format settings that your HDTV supports.



Important: Before you start, read these instructions carefully. When you get to step 5, you have 20 seconds to begin selecting picture format settings. After 20 seconds, the set-top is no longer in the **Picture Format** mode. If this occurs, repeat this process, starting at step 2.

1. Refer to the user guide that came with your HDTV to find the picture formats that your HDTV supports.
2. If the set-top is turned off, press the **POWER** key to turn it on.
3. On the front of the set-top, press and hold the **SELECT** button until the message light blinks.
4. Then, press the **VOL-** key to indicate that you want to select a picture format setting. The LED display shows HdSr to indicate that the set-top is in the Picture Format mode for HDTV settings.
5. In the following table, find each of the picture formats that your HDTV supports. Then, press the corresponding buttons on the front panel of the set-top.

Note: If 1080i is one of the settings that your HDTV supports, we suggest you select it last. Then, when you turn on the TV to use the Setup Wizard, the picture format will be 1080i.

To select this picture format:	Press this button on the front panel:	The set-top briefly displays:	And then briefly displays:
480i	CH+	480i	SEt
720p	VOL-	720p	SEt
480p	CH-	480p	SEt
1080i	VOL+	1080	SEt

SETUP WIZARD

IS THERE MORE THAN ONE SETUP OPTION?

Yes. The Setup Wizard provides two options for selecting your screen type:

- If you choose the **Easy option**, the Setup Wizard automatically sets up the HDTV to receive programming in 1080i and 480i formats.
- If you choose the **Advanced option**, you can toggle through all the picture formats and select the formats that look best on the HDTV screen.

Note: Use the **▲**, **■** and **●** keys on the remote control to navigate through the Setup Wizard menus and options. You may want to have available the user guide that came with your HDTV for reference.

HOW DO I START THE SETUP WIZARD?

1. Make sure that the set-top is **off** and the HDTV is **on**.



2. Press the **GUIDE** and **INFO** keys at the same time.

1. Press **△** to start the setup.



2. Choose one of the following options:
 - To choose the **Easy Setup** option, press **△**; then, go to the **Easy Setup Instructions** on page 61.
 - To choose the **Advanced Setup** option, press **■**; then go to the **Advanced Setup Instructions**, on page 62.



SETUP WIZARD

EASY SETUP INSTRUCTIONS

1. Press **△** or **■** to select the type of TV screen you have.

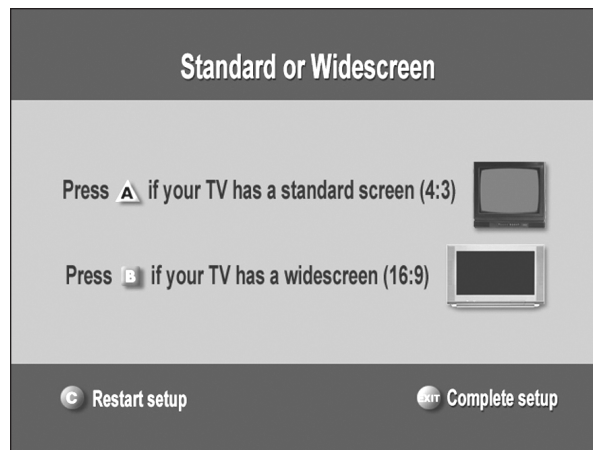

2. Press **POWER** to begin watching TV.

Notes:

- If you pressed **△**, the setup is complete. The TV is set to receive programming in 1080i and 480i formats.
- If you pressed **■**, proceed to next page.

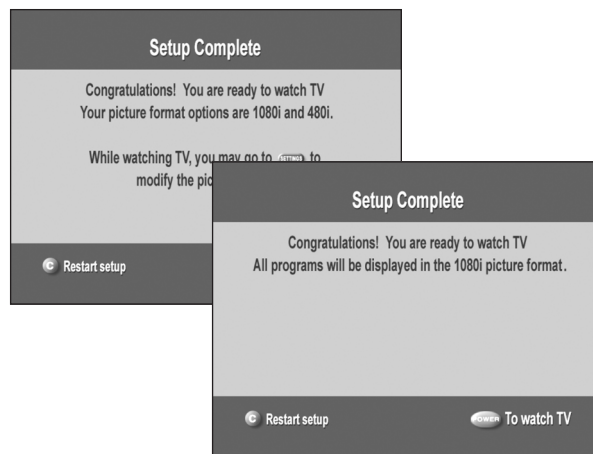

ADVANCED SETUP INSTRUCTIONS

1. Press **▲** or **■** to select the type of TV screen you have.

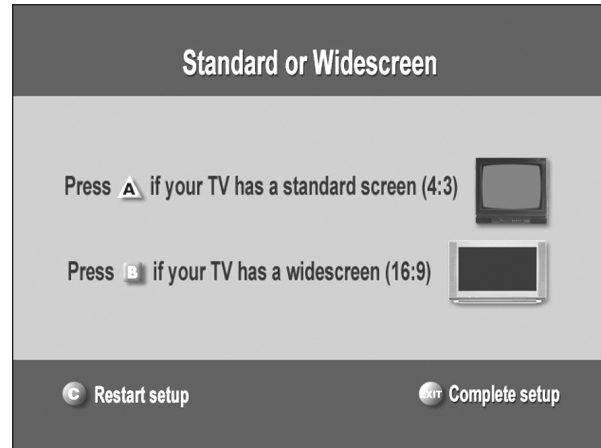

2. Press **▲** to see how various formats look on your TV screen.

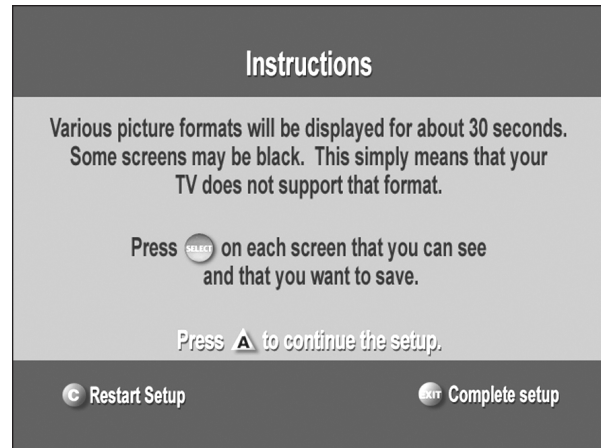

SETUP WIZARD

3. Press **SELECT** to toggle between the Save and Remove options, or press **B** to see how the next format looks on your TV screen.

Important: If you see a black screen, press **B** again to view the next screen. Do not press **SELECT**. The black screen means that your TV does not support that particular format, so you do not want to select it.

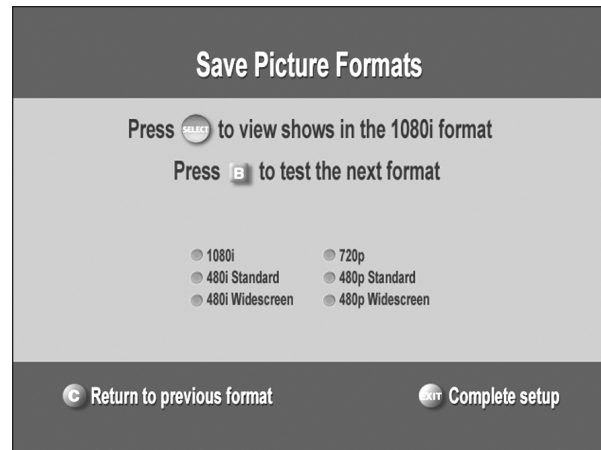

4. After saving the picture formats, press **EXIT**. The setup is complete.
5. Press **POWER** to begin watching TV.



CLOSED-CAPTIONING

WHAT IS CLOSED-CAPTIONING?

Closed-captioning is text on the TV screen related to the programming being viewed. What you see is an abbreviated version of the actors' dialogue and indications of important background sounds. For sporting events, closed-captioning provides realtime play-by-play descriptions from the announcers. Closed-captioning is provided for those requiring assistance understanding and enjoying sound.

Closed-captioning sources for digital programming

- **Digital 1** is the primary caption source.
- **Digital 2** is the suggested choice for alternate languages.
- **Digital 3** through **Digital 6** are undefined at this time.

CHOOSE A CLOSED-CAPTIONING SOURCE

1. Press **SETTINGS** twice to access the **General Settings** menu.
2. Scroll to **CC: Source**.
3. Press **▶** to access the STD (analog) and digital source options.
4. Scroll through the options and select the recommended source: **Digital 1**.

TURN CLOSED-CAPTIONING ON AND OFF

You can turn closed-captioning on and off at any time through the Quick Settings menu.

1. Press **SETTINGS** to access the **Quick Settings** menu while watching TV.
2. Turn caption on or off.
3. If you chose the **Fixed** setting for the audio volume:
 - A. Scroll to **Caption Off/On**.
 - B. Press **▶** to access the options.
 - C. Scroll through the options and press **SELECT** to set your choice.
4. If you chose the **Variable** setting for the audio volume:
 - A. Scroll to **Caption Off/On/On with Mute**.
 - B. Press **▶** to access the options.
 - C. Scroll through the options and press **SELECT** to set your choice.

FREQUENTLY ASKED QUESTIONS

WHAT IS HDTV? WHAT ADVANTAGES DOES IT HAVE OVER STANDARD DIGITAL TV ?

HDTV, or high-definition television, is a next-generation standard for digital television that gives you an image with superior resolution. Standard televisions display approximately 210,000 pixels, compared to over 2 million for top-end HDTV – a tenfold increase over traditional TV. Plus, HDTV enhances the home theatre experience by allowing for wider screens with aspect ratios of 16:9. Among other things, this can preserve a film’s original letterbox format.

IF I DON’T HAVE AN HDTV, WILL AN HD TERMINAL GIVE ME A SHARPER IMAGE?

No. Vidéotron’s HD terminals are perfectly backward compatible with traditional TV, but to take advantage of the higher resolution offered by HD broadcasts, your television must be physically capable of displaying the necessary number of pixels – and must be equipped with connectors that can carry this type of signal (Component/DVI/HDMI input).

TECHNICALLY, WHAT’S THE DIFFERENCE BETWEEN HDTV AND TRADITIONAL ANALOG SDTV?

There are several technical differences between standard, NTSC-format television and HDTV. (Technology varies widely even among HDTVs: CRT, LCD, Plasma, DLP, etc.)

TVs project programs onto their screens in the form of tiny picture elements, or pixels: 480 lines of pixels make up the picture on a standard analog TV. In comparison, HDTV images use 720 or 1080 lines, which results in much sharper detail and general picture resolution.

This also lets the image be “painted” in different ways. On an SDTV, the screen is painted using interlaced scanning, meaning that each of the 30 images appearing on-screen each second is made up of two half-images: one each for the odd and even lines. HDTV can use either interlaced or progressive scanning (the latter changes the entire image from the first to last line up to 60 times a second).

The two HDTV formats:

720p	720 lines of horizontal resolution and progressive scan
1080i	1080 lines of horizontal resolution and interlaced scan

WHICH IS BETTER, 720P OR 1080I? HOW DO THESE COMPARE WITH DVDS OR THE TRADITIONAL DIGITAL TERMINAL FORMAT?

Progressive scan provides superior results compared to interlaced scan, the main difference being that interlaced scan’s alternating lines are more readily visible to the naked eye.

While a 720p image contains fewer pixels than a 1080i image, it also can be refreshed more quickly, making it the better choice for programs featuring a lot of movement, such as sports broadcasts.

To compare: both SDTV and DVD images use 480 horizontal lines with interlaced scan (480i). So-called progressive scan DVD players provide images in 480p format, resulting in better picture quality.

WHAT'S THE RESOLUTION ON VIDÉOTRON'S HD CHANNELS? CAN I CHOOSE THE RESOLUTION OF THE SIGNAL I RECEIVE?

Television stations decide which format a program will be broadcast in – although this doesn't mean all of a station's programs will necessarily be broadcast in the same format.

It's important to make the distinction between the image resolution you receive from a station, and the format your television displays it in. For example: if a station broadcasts a program at 480i and you have a 1080i TV, it will convert the image to a uniform 1080 on-screen lines by filling in the missing pixels. The program's "real" resolution, however, stays unchanged at 480i.

I'VE NOTICED SEVERAL CAPTIONING OPTIONS IN MY HD TERMINAL'S GENERAL SETTINGS, SUCH AS FONT SIZE AND COLOUR. WHY ARE MY CAPTIONS ALWAYS IN BLACK AND WHITE?

Make sure the Captioning Options in your General Settings are set to Personalized. Custom font size and colour are only available for programs broadcast using the new digital captioning standard, EIA-708B. Programs broadcast using the old captioning standard, 608, do support captions, but only in black and white. A program's captioning standard is decided by the television station.

WHAT DOES AN HDTV'S "NATIVE FORMAT" REFER TO?

As you know, digital television programs can be broadcast in a variety of formats (480i, 480p, 720p, 1080i, etc.) – but TVs are designed and built to display images in only one of these formats. This format is the TV's native format. This is why HDTVs must be equipped to convert the formats of the programs they receive.

HDTVs are often classified according to their native formats. Today's models are designed to display images at either 720p or 1080i. If an LCD TV with a native format of 720p receives a signal from a television station at 480i, it converts it to its native format: 720p. To do this, it "fills in" the incoming image's missing pixels, bringing it up to its display capacity. The resulting image will always be in the same format: your TV's native format.

Free Manuals Download Website

<http://myh66.com>

<http://usermanuals.us>

<http://www.somanuals.com>

<http://www.4manuals.cc>

<http://www.manual-lib.com>

<http://www.404manual.com>

<http://www.luxmanual.com>

<http://aubethermostatmanual.com>

Golf course search by state

<http://golfingnear.com>

Email search by domain

<http://emailbydomain.com>

Auto manuals search

<http://auto.somanuals.com>

TV manuals search

<http://tv.somanuals.com>