Connecting the Explorer[®] 8300HDC[™] Digital Video Recorder



**Scientific
Atlanta**
A CISCO COMPANY

Notice for CATV Installers

CATV Installers Notice

If you are a CATV installer, read the information in the box below.

<p>Note to CATV System Installer (U.S.A. and Canada Only)</p> <p>This reminder is provided to call the CATV system installer's attention to Article 820-40 of the NEC (Section 54, Part I of the Canadian Electrical Code), that provides guidelines for proper grounding and, in particular, specifies that the CATV cable ground shall be connected to the grounding system of the building, as close to the point of cable entry as practical.</p> <div data-bbox="537 758 667 873"></div> <p>This symbol is intended to alert you that uninsulated voltage within this product may have sufficient magnitude to cause electric shock. Therefore, it is dangerous to make any kind of contact with any inside part of this product.</p>	<div data-bbox="881 432 967 510"></div> <table border="1" data-bbox="987 386 1198 569"><tr><td>CAUTION</td></tr><tr><td>RISK OF ELECTRIC SHOCK DO NOT OPEN</td></tr><tr><td>AVIS</td></tr><tr><td>RISQUE DE CHOC ÉLECTRIQUE NE PAS OUVRIR</td></tr></table> <div data-bbox="1219 432 1305 510"></div> <p>CAUTION: To reduce the risk of electric shock, do not remove cover (or back). No user-serviceable parts inside. Refer servicing to qualified service personnel.</p> <p>WARNING TO PREVENT FIRE OR ELECTRIC SHOCK, DO NOT EXPOSE THIS UNIT TO RAIN OR MOISTURE.</p> <div data-bbox="1027 783 1157 898"></div> <p>This symbol is intended to alert you of the presence of important operating and maintenance (servicing) instructions in the literature accompanying this product.</p>	CAUTION	RISK OF ELECTRIC SHOCK DO NOT OPEN	AVIS	RISQUE DE CHOC ÉLECTRIQUE NE PAS OUVRIR
CAUTION					
RISK OF ELECTRIC SHOCK DO NOT OPEN					
AVIS					
RISQUE DE CHOC ÉLECTRIQUE NE PAS OUVRIR					

U.S. Patents

U.S. Patents List

A patent notice is affixed to this product. In addition, the product may also be covered by one or more of the following patents:

4,498,169; 4,636,852; 4,641,181; 4,651,208; 4,691,353; 4,692,919; 4,698,598; 4,719,642; 4,748,667; 4,829,569; 4,866,770; 4,885,775; 4,888,799; 4,890,319; 4,922,456; 4,922,532; 4,924,498; 4,965,534; 4,991,011; 5,003,384; 5,012,510; 5,029,207; 5,045,816; 5,053,883; 5,054,071; 5,058,160; 5,142,575; 5,142,690; 5,146,526; 5,155,590; 5,214,390; 5,225,902; 5,225,925; 5,235,619; 5,237,610; 5,239,540; 5,241,610; 5,247,364; 5,255,086; 5,257,403; 5,267,071; 5,270,809; 5,271,041; 5,272,752; 5,282,028; 5,285,497; 5,287,351; 5,301,028; 5,309,514; 5,317,391; 5,319,709; 5,341,425; 5,347,388; 5,347,389; 5,357,276; 5,359,601; 5,361,156; 5,367,571; 5,379,141; 5,379,145; 5,381,481; 5,390,337; 5,400,401; 5,406,558; 5,418,782; 5,420,866; 5,420,923; 5,425,101; 5,428,404; 5,430,568; 5,434,610; 5,436,749; 5,438,370; 5,440,632; 5,442,472; 5,455,570; 5,457,701; 5,471,492; 5,477,199; 5,477,262; 5,477,370; 5,481,389; 5,481,542; 5,485,221; 5,493,339; 5,497,187; 5,500,758; 5,502,499; 5,506,904; 5,519,780; 5,539,822; 5,550,825; 5,579,055; 5,579,057; 5,583,562; 5,592,551; 5,596,606; 5,600,378; 5,602,933; 5,640,388; 5,657,414; 5,675,575; 5,684,876; 5,715,515; 5,724,525; 5,740,300; 5,742,677; 5,754,940; 5,757,416; 5,771,064; 5,774,859; 5,825,829; 5,826,167; 5,850,305; 5,854,703; 5,870,474; 5,892,607; 5,920,626; 5,923,755; 5,930,024; 5,930,515; 5,937,067; 5,963,352; 5,966,163; 5,982,424; 5,991,139; 5,999,207; 6,005,631; 6,005,938; 6,016,163; 6,028,941; 6,029,046; 6,052,384; 6,055,244; 6,072,532; 6,105,134; 6,148,039; 6,157,719; 6,188,729; 6,195,389; 6,212,278; 6,215,530; 6,219,358; 6,240,103; 6,243,145; 6,246,767; 6,252,964; 6,272,226; 6,292,081; 6,292,568; 6,320,131; 6,374,275; 6,405,239; 6,411,602; 6,417,949; 6,424,714; 6,424,717; 6,433,906; 6,438,139; 6,463,586; 6,467,091; 6,476,878; 6,493,876; 6,510,519; 6,516,002; 6,516,412; 6,526,508; 6,538,595; 6,546,013; 6,560,340; 6,567,118; 6,570,888; 6,622,308; 6,629,227; 6,664,984; 6,667,994; 6,671,879; 6,674,967; 6,678,891; 6,714,598; 6,721,352; 6,721,956; 6,725,459; 6,738,982; 6,744,892; 6,744,967; 6,751,271; 6,760,918; 6,795,972; 6,802,077; 6,804,708; 6,811,447; 6,817,028; 6,822,972; 6,823,385; 6,832,386; 6,845,106; 6,868,473; 6,874,075; 6,889,191; 6,909,471; 6,917,622; 6,917,628; 6,922,412; 6,927,806; 6,928,656; 6,931,058; 6,937,729; 6,969,279; 6,971,008; 6,971,121; 6,978,310; D348065; D354959; D359737; D363932; D390217; D434753; D507240; D507535; RE36368; RE36988

20051216SI

Contents

Important Safety Instructions	iv
Welcome	1
Safety First	1
The Explorer eClub	1
Identify Your 8300HDC	1
What's in the Carton?	2
Additional Equipment You Might Need	2
What's on the Front Panel?	3
What's on the Back Panel?	4
Connecting the 8300HDC	5
Connections for an HDTV and VCR	6
Connections for a Standard-Definition TV and VCR	7
View and Record Television Programming	8
Performance Tips	9
Frequently Asked Questions About HDTV	10
Picture Formats	11
Connecting the 8300HDC to an HDTV with an HDMI Connector	12
Connecting the 8300HDC to an HDTV with a DVI Connector	13
Connecting the 8300HDC to an HDTV with Component Input (PrPbY/V)	14
Connecting the 8300HDC to a Home Theater System with Component Input (PrPbY/V)	15
Connecting the 8300HDC to a Stereo VCR and HDTV (optional)	16
Connecting the 8300HDC to an External SATA Hard Disk Drive (optional)	17
Connecting the 8300HDC to an HDTV with a 1394 Connector	19
Connecting the 8300HDC in HD Mode to an SDTV with Component Input (PrPbY/V)	19
Compliance Information	20
Index	21

IMPORTANT SAFETY INSTRUCTIONS

Heed Warnings

Adhere to all warnings on the product and in the operating instructions.

Read, Retain, and Follow These Instructions

Read all of the instructions before you operate this product. Follow all operating instructions that accompany this product. Retain the instructions for future use. Give particular attention to all safety precautions.

Comply With Warnings

Avoid electric shock. Comply with all warnings and cautions in the operating instructions, as well as those that are affixed to this product.

Power Warnings

Providing a Power Source

A label on this product indicates the correct power source for this product. Operate this product only from an electrical outlet with the voltage and frequency indicated on the product label.

If you are uncertain of the type of power supply to your home or business, consult your cable service provider or your local power company.

Grounding This Product (U.S.A. and Canada Only)



WARNING: To avoid electric shock and fire hazard, match the plug and outlet connections carefully, then fully insert. If the plug and outlet do not match, or you cannot fully insert the plug, contact an electrician to update your power outlets.

If this product is equipped with either a three-prong (grounding pin) safety plug or a two-prong (polarized) safety plug, follow these safety guidelines to properly ground this product:

- For a 3-prong plug (one prong on this plug is a protective grounding pin), insert the plug into a grounded mains, 3-prong outlet.

Note: This plug fits only one way. If you are unable to insert this plug fully into the outlet, contact your electrician to replace your obsolete outlet.

- For a 2-prong plug (a polarized plug with one wide blade and one narrow blade), insert the plug into a polarized mains, 2-prong outlet in which one socket is wider than the other.

Note: If you are unable to insert this plug fully into the outlet, try reversing the plug. If the plug still fails to fit, contact an electrician to replace your obsolete outlet.

Overloading



WARNING: Avoid electric shock and fire hazard! Do not overload mains AC outlets and extension cords. For products that require battery power or other power sources to operate them, refer to the operating instructions for those products.

Do not overload electrical outlets, extension cords, or integral convenience receptacles as this can result in a risk of fire or electric shock. For products that require battery power or other sources to operate, refer to the operating instructions for that product.

Preventing Power Cord Damage

Arrange all power cords so that people or pets cannot walk on the cords. Do not place objects on the cords. Do not lean objects against the cords. Placing objects on or leaning objects against cords can damage the cords. Give particular attention to cords at the point at which the cord connects to plugs, at the electrical outlets, and where the cords exit the product.

Usage Warnings

Providing Ventilation

This product has openings for ventilation that protect it from overheating. To ensure the reliability of this product, do the following:

- Do not block or cover these openings.
- Do not place entertainment devices (such as VCRs or DVDs), lamps, books, vases with liquids, or other objects on top of this product.
- Do not place this product in any of the following locations:
 - On a bed, sofa, rug, or similar surface
 - Near heat sources such as radiators, heat registers, stoves, or other products (including amplifiers) that produce heat
 - In an enclosure, such as a bookcase or rack, unless the installation provides proper ventilation

Selecting a Proper Location



WARNING: Avoid personal injury and damage to this product! An unstable surface may cause this product to fall.

Place this product in a location that is close enough to an electrical outlet and where the power cord is easily accessible to be disconnected from the wall outlet or from the rear panel of the product.

Important: The power cord is the mains power supply disconnect device.

Place this product on a stable surface. The surface must support the size and weight of this product.

Cleaning This Product



WARNING: Avoid electric shock! Unplug this product before cleaning.

Before cleaning this product, unplug it from the electrical outlet. Use a damp cloth to clean this product. Do not use a liquid cleaner or an aerosol cleaner. Do not use a magnetic/static cleaning device (dust remover) to clean this product.

IMPORTANT SAFETY INSTRUCTIONS, continued

Protecting This Product From Foreign Objects and Water or Moisture Damage



WARNING: Avoid electric shock and fire hazard! Never push objects through the openings in this product. Foreign objects can cause electrical shorts that can result in electric shock or fire. Do not expose this product to rain or moisture. Do not place objects filled with liquid, such as vases, on this product.

Never push objects of any kind into this product through openings as they may touch dangerous voltage points or short out parts that could result in a fire or electric shock.

Do not expose this product to liquids or moisture. Do not place this product on a wet surface. Do not spill liquids on or near this product.

Do not use this product near water (such as a bath tub, wash bowl, sink, or laundry tub), in a wet basement, or near a swimming pool.

Accessories Warnings



WARNING: Avoid any potential for electric shock or fire. Do not use accessories with this product unless recommended by your cable service provider.

Avoid any potential for electric shock or fire. Do not use accessories with this product unless recommended by your cable service provider.

Service Warnings

Servicing This Product



WARNING: Avoid electric shock! Opening or removing the cover may expose you to dangerous voltages. This product contains no user-serviceable parts. Refer all servicing to qualified service personnel.

Do not open the cover of this product. If you open the cover, your warranty will be void. Refer all servicing to qualified personnel only. Contact your cable service provider for instructions.

Obtaining Service for Product Damage

For damage that requires service, unplug this product from the AC outlet. Then, contact your cable service provider or qualified service personnel to obtain service for the following conditions:

- If there is damage to the power-supply cord or plug
- If liquid enters this product
- If you expose this product to rain or water
- If you drop this product, a heavy object falls on this product, or damage occurs to the cover of this product
- If this product does not operate normally by following the operating instructions
- If this product exhibits a distinct change in performance

Checking Product Safety

Upon completion of any service or repairs to this product, the service technician must perform safety checks to determine that this product is in proper operating condition.

Outdoor Grounding System

If this product connects to an outdoor antenna or cable system, be sure the antenna or cable system is grounded (earthed). This provides some protection against voltage surges and built-up static charges.

Article 810 of the National Electric Code (NEC) ANSI/NFPA No. 70-1990, provides the following information:

- Grounding of the mast and supporting structure
- Grounding the lead-in wire to an antenna discharge unit
- Size of the grounding conductors
- Location of the antenna-discharge unit
- Connection to grounding electrodes
- Requirements for the grounding electrodes (see the following antenna grounding diagram as recommended by NEC ANSI/NFPA 70)

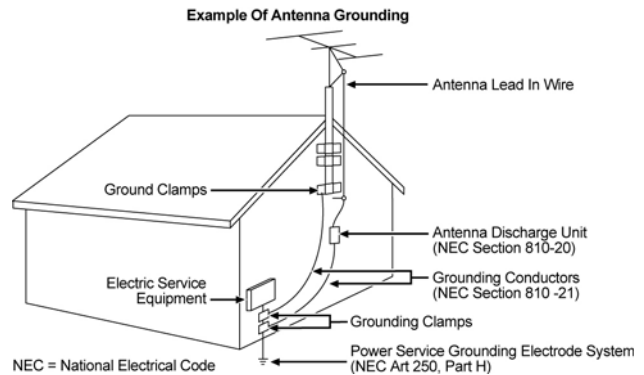

Lightning

For added protection for this product during a lightning storm, or when it is left unattended and unused for long periods of time, unplug it from the wall outlet and disconnect the antenna or cable system. This will prevent damage to the product due to lightning and power-line surges. Plugging this product into a surge protector may reduce the risk of damage.

Note: Unplugging this product for an extended period of time can result in loss of authorization. For reauthorization, contact your cable service provider.

Power Lines



WARNING: To avoid electric shock, do not locate an outside antenna system in the vicinity of overhead power lines or power circuits.

Do not locate an outside antenna system in the vicinity of overhead power lines or power circuits. When installing an outside antenna system, take extreme care to keep from touching power lines or circuits, as contact might be fatal.

20050719STBD

Welcome

DVR makes it easy to watch TV on your terms.

The Explorer® 8300HDC™ Digital Video Recorder (DVR) is the simple way to take control over your TV – and your life. You take control because DVR lets you decide what's on TV and when. So there's no more putting off the things you need to do, just because there's a show on TV you want to watch. Just think what DVR can do for you:

- Never miss a minute of your favorite movie or the big game. Simply pause the live action and play again when you're ready. You can even rewind what you missed.
- Two of your favorite shows on at the same time? Simple. Just record one program while you watch the other. You can even record two programs at the same time while watching a previously recorded program. Your VCR can't do that.
- Is your favorite sports team having an away game and you can't go? Imagine being able to record it and watch it in high definition (HD) at a more convenient time. In HD, the picture is so clear you'll almost forget that you're not there.

Don't miss another minute of the TV shows you love!

Follow the instructions in this guide to install the 8300HDC, to become familiar with the buttons on the front panel, and to access your cable services. Then, enjoy the features of the 8300HDC and change the way you watch TV!

Find out more!

Join the Explorer eClub for more information about this DVR! Get details in the **Explorer eClub** section later in this document.

Safety First

Before using the 8300HDC, read the **Important Safety Instructions** section of this guide.

The Explorer eClub

Visit the online Explorer eClub for more information about this DVR, including additional connection diagrams, documentation, "how-to" tips, and FAQs. You can access the Explorer eClub on the Internet at the following Web address:

www.scientificatlanta.com/explorerclub

To join and access the online Explorer eClub, you need to enter the model number of your DVR. The model number is located on the front panel.

Identify Your 8300HDC

To find the serial number for your 8300HDC, look on the back for a label that is similar to the example shown here. The serial number begins with "SA" and is located in the lower left corner of the bar code.

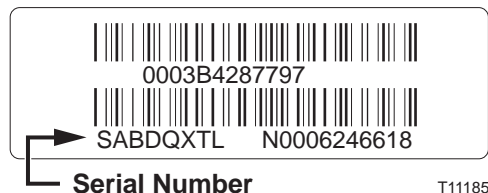

If your 8300HDC requires troubleshooting in the future, your cable service provider may ask for this serial number.

Use the space provided here to record the serial number:

What's In The Carton?

The DVR set-top carton contains the following items:



• 8300 HDC DVR



• Connection Guide



• Power Cord



• Component Video Cables (PrPbY/V)



• Audio Left/Right Cable

Additional Equipment You Might Need

You might need some of the cables and adapters shown below for connecting the DVR to your home entertainment devices. See the connection information beginning on page 12 of this guide for more information.

Check with your cable service provider for information about acquiring cables or adapters, or you can purchase cables or adapters at your local electronics supplier.



Multi-stream CableCard
(obtain from your cable service provider)



Composite A/V Cables



HDMI Adapter



S-Video Cable



RGB Adapter Cable
(RCA to RCA)



RGB Adapter



HDMI-to-HDMI Cable



RGB Adapter Cable
(RCA to BNC)



RGB Adapter Cable
(RCA to VGA)



HDMI-to-DVI Cable



Optical Digital Audio Cable



IEEE 1394 6-Pin to 4-Pin Cable



RF Coaxial Cable





Coaxial Digital Audio Cable

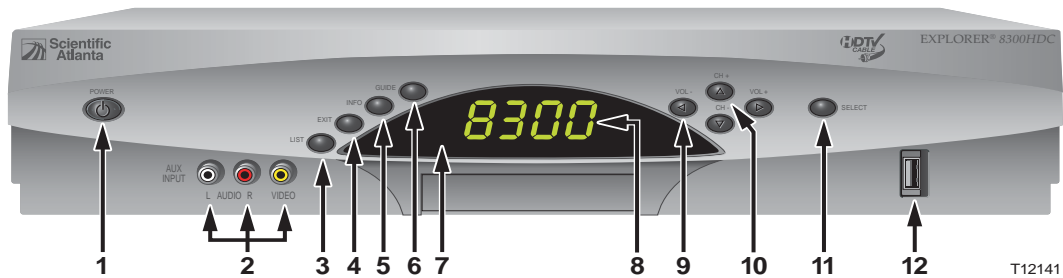

IR Extender Cable

What's on the Front Panel?



- | | |
|--------------------------------|---|
| 1 Power | Turns the 8300HDC on and off |
| 2 Video and Audio Input | Connects to video and left/right (L/R) audio outputs of an external device to deliver the audio and video to a TV or other device |
| 3 List | Displays the list of recorded programs |
| 4 Exit | Exits menus, the on-screen guide, and program information |
| 5 Info | Displays a description of the selected program. This button is available from the on-screen guide and while viewing a program |
| 6 Guide | Accesses on-screen services, such as the on-screen guide, video-on-demand, or pay-per-view |
| 7 IR Sensor | Receives the infrared signal from the remote control |
| 8 LED Display | Displays the selected channel number and time of day. The LED also displays the following: <ul style="list-style-type: none"> • Message () • HDTV • Power () • Output Resolution (1080i, 720p, 480p, or 480i) • RECORD • AUTO - Automatically outputs native scan rates that your TV can accept |
| 9 VOL + and VOL - | Increases and decreases the volume |
| 10 CH + and CH - | Scrolls up and down through the channels |
| 11 Select | Provides access to your on-screen selection |
| 12 USB Port | Connects to external equipment, such as a keyboard or mouse (reserved for future use, may not be available on all 8300HDC models) |

What's on the Back Panel?

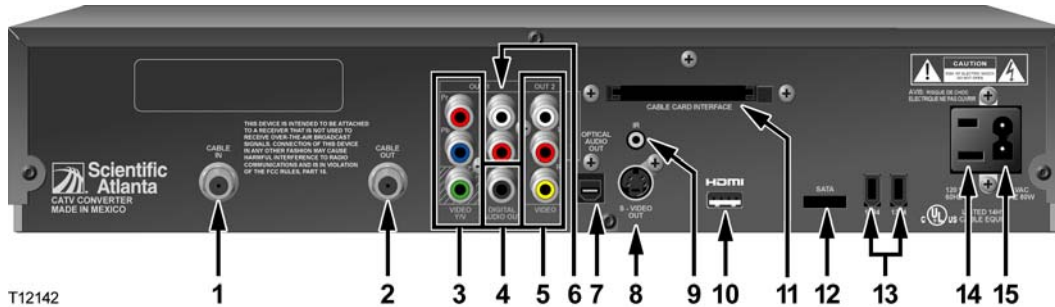

T12142

- 1 **Cable In** Connect the coaxial cable that delivers the signal from your cable service provider
- 2 **Cable Out** Connect a coaxial cable to send analog audio and video signals to a TV or VCR. These signals are standard-definition TV (SDTV) video and stereo audio
- 3 **PrPbY/V** Connect the 8300HDC (in **HD mode**) to the component video input (YPrPb) on the HDTV. When the 8300HDC is configured for **SD mode**, the Y/V portion of the component video output connects to the composite video input of an SDTV. See **Connections for an HDTV and VCR** on page 6 or **Connections for a Standard-Definition TV and VCR** on page 7 for complete details
- 4 **Digital Audio Out** Connect an RCA cable to send a digital audio signal to a surround-sound receiver or other digital audio device
- 5 **Out 2 (Secondary Video and Audio Out)** Connect to either a VCR for archiving saved content from the 8300HD or connect to another set of inputs (composite) on your HDTV
- 6 **Audio Out (LEFT and RIGHT)** Connect RCA cables to send analog audio signals (left and right) to the stereo outputs of an HDTV
- 7 **Optical Audio Output** Connect an optical cable to send a digital audio signal to a surround-sound receiver or other digital audio device
- 8 **S-Video Out** Connect an S-Video cable to send an S-Video signal to your TV or VCR. This signal is standard definition but higher quality than other SDTV connections
- 9 **IR** (This connector reserved for future use)
- 10 **HDMI** Connect the HDTV HDMI™ connector to the HDMI port. HDMI supports both digital audio and video. May be used to connect to a DVI interface using an adaptor for video and separate audio connections. You can use any of the following audio connections: Digital Audio Out (4), Audio Out [LEFT and RIGHT] (6), or Optical Audio Out (7)
- 11 **CableCARD™** Slot for CableCARD multi-stream card for decrypting subscription digital channels. Obtain the multi-stream card from your cable service provider.
- 12 **SATA** Connect to an external Serial ATA (SATA) hard disk drive for expanded recording capacity. Check with your cable service provider for a list of approved hard drive models for use with the 8300HDC
- 13 **1394 Outputs** Connect to display devices equipped with 1394 inputs. These connectors might not be available on all 8300HDC models. When you connect the DVR-DVD to your TV using 1394, you must make additional video and audio connections to your TV to receive analog signals
- 14 **AC Outlet** Connect the AC power cord from another device, such as a TV
- 15 **AC Power Input** Connect the power cord to deliver power to the 8300HDC

Connecting the 8300HDC

To connect your 8300HDC to your entertainment devices, complete these steps.



Determine if your TV is HD or SD and whether it is wide screen (16:9) or standard screen (4:3). **See page 11** for more information.



or

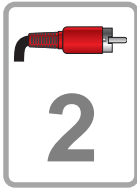

Make the connections for your TV and VCR as follows:

- If you are using an HDTV, **see page 6** and the connection diagrams at the end of this guide.
- If you are using an SDTV, **see page 7** and the connection diagrams at the end of this guide.
- If you want to archive some programs to VCR tape, **see pages 6 and 7** and the connection diagrams at the end of this guide.



Identify the additional devices you will connect to the 8300HDC and TV. **See pages 12 through 19** and the related user guides for more information.

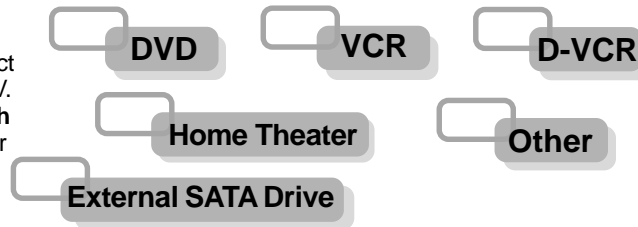

Plug the 8300HDC and the TV into an AC power source that is not controlled by a switch.



Do not turn on the 8300HDC or TV yet.



It may take several minutes for the 8300HDC to receive the latest software, programming, and service information. Wait until you see one of the following displays on the front panel of the 8300HDC that indicates that the update is complete:

- Current time
- Four dashes (- - - -)

Note: If four dashes are displayed, you must call your cable service provider to get the 8300HD authorized.



Set up your 8300HDC for HDTV or SDTV by completing the following steps:

- Make sure the 8300HDC is **Off** and the TV is **On**.
- On the front panel of the 8300HDC, press **GUIDE** and **INFO** at the same time.
- Follow the on-screen instructions to choose **HD** or **SD** mode and wide screen (16:9) or standard screen (4:3) depending upon your TV type. **See Page 10** for more information on the scan rate.
- At the conclusion of the on-screen instructions, press **POWER** on the 8300HDC to begin watching TV.

Connections for an HDTV and VCR

To use the 8300HDC with an HDTV, you must make *one* of the following connections to view the HD content. In addition, you can make connections to a digital or analog VCR to archive recordings to a VCR tape. Refer to your TV and VCR users guides and the cabling diagrams in this guide for more detailed connection information.

Note: The labeling on your 8300HDC may vary slightly.

Required Connections to an HDTV (use one)		8300HDC Connections	HDTV Connections
HDMI	Some HDTVs have a High-Definition Multimedia Interface (HDMI) connector. The HDMI connector provides both a digital video and audio connection. See the connection diagram on page 12 for an example.		
DVI	The HDMI connector can provide the connection to an HDTV with a DVI input. If your HDTV has a Digital Visual Interface (DVI) connector, you will need an HDMI-to-DVI adapter, and you will need to connect a separate audio connection. See the connection diagram on page 13 for an example.	 OUT 1 L R Adapter Needed	 L R
PrPbY/V	The Y/V PbPr connectors can provide high-definition component video signals to an HDTV. Note: Use the HD Setup Wizard on the 8300HDC to set the HD mode and select the output video format that will matches the full capabilities of your HDTV. See the connection diagram on page 14 for an example.	 OUT 1 L R	 L R
RGB	Some HDTVs have only RGB connectors. If you have one of these HDTVs, you need an RGB adapter. Check with your cable service provider for information about acquiring an RGB adapter, or you can purchase the adapter at your local electronics supplier.	 OUT 1 L R RGB and Audio Adapters Needed	 L R
1394	Some HDTVs have 1394 connectors. If you connect to your HDTV using 1394, you also need to connect separate video and audio connections to your HDTV. See the connection diagram on page 19 for an example.	 OUT 1 L R	 L R
Optional Connections to a VCR (use one)		8300HDC Connections	VCR Connections
VCR	For VCRs with Video and Left and Right audio connectors, you can use the Out 2 connectors (Video, Left, and Right) on the 8300HDC. See the connection diagram on page 16 for an example.		
	For VCRs with S-Video and Left and Right audio connectors, you can use the S-Video Out and the Out 2 Left and Right connectors on the 8300HDC.		
	For <i>Digital VCRs</i> , you can use the 1394 out connector on the DVR-DVD.		

Connections for a Standard-Definition TV and VCR

When using the 8300HDC with an SDTV, you must make *one* of the following connections to view content. Some SDTVs may not have all these connections. In addition, you can make connections to a VCR to archive recordings to a VCR tape. Refer to your TV and VCR user guides and the cabling diagrams in this guide for more detailed information.

Note: The labeling on your 8300HDC may vary slightly.

Required Connections to an SDTV (use one)		8300HDC Connections	SDTV Connections
PrPbY/V	<p>The Y/V PbPr connectors can provide standard-definition component video signals to an SDTV.</p> <p>Note: To connect PrPbY/V to an SDTV, you must set the HD Setup Wizard on the 8300HDC to HD Mode, and select the output video format (typically 480i) that will match the capabilities of your SDTV.</p>		
Composite	<p>When you set up the 8300HDC in SD mode, the Y/V connector on the 8300HDC is configured as a composite video out connector (V).</p> <p>See the connection diagram on page 19 for an example.</p>		
S-Video	<p>The S-Video Out connection provides an optimal video connection to SDTVs.</p>		
Cable Out	<p>The Cable Out connector provides a video and audio connection to an SDTV.</p>		
Optional Connection to a VCR		8300HDC Connections	VCR Connections
VCR	<p>For VCRs with Video and Left and Right Audio connectors, you can use the Out 2 connectors (Video, Left, and Right) on the 8300HDC.</p>		

View and Record Television Programming

Access Services and Programs

Access cable services and programs by pressing the following keys on the remote control:

- **Guide**—Access the on-screen guide. The on-screen guide displays schedules of TV programs and other services available from your cable service provider, such as video-on-demand and pay-per-view programs.
- **Arrows**—Select a program in the schedule.
- **Info**—Display a specific program description (either from the on-screen guide or while viewing a program).
- **Select**—View a specific program in the guide.



Record One Program While Watching Another

When two of your favorite programs are scheduled at the same time, you can record one program on the built-in DVR while watching the other. Use the DVR keys on the remote control to record programs or to play back recorded programs.

Watch Two Programs at the Same Time

You do not need a special TV to watch two programs at the same time. Use the picture-in-picture (PIP) keys on the remote control, and you will see a PIP screen on your TV.

Stretch and Zoom Program

You can stretch and zoom SD or HD programs by pressing the # key on the remote control.



Avoid Screen Burn-In!

Images such as letterbox bars or side bars, bright closed-captioning backgrounds, station logos, or any other stationary images may cause the picture tube in your HDTV to age unevenly; this is known as screen burn-in. Refer to the user's guide that came with your HDTV for more information.



WARNING:
Avoid screen burn-in!
Do not display the same fixed images on your HDTV screen for extended periods of time.

Troubleshooting

If the 8300HDC does not perform as expected, the following tips may help. If you need further assistance, contact your cable service provider.

No Picture

- Verify that the power to your TV is turned on.
- Verify that your HDTV is in HD mode. If necessary, run the HD Setup Wizard to select HD mode.
- If the 8300HDC is plugged into a wall switch, verify that the switch is in the ON position.
- Verify that all cables are properly connected.
- If your system includes a VCR or stereo, verify that you have properly connected them to the 8300HDC.
- Verify that the 8300HDC is set to the proper screen type and resolution.

No Color

- Verify that the current TV program is broadcast in color.
- Adjust the TV color controls.
- If you are using a component video connection (PrPbY/V), check that all connectors are completely plugged into the 8300HDC and TV.

No Sound

- If your setup includes a VCR or stereo, verify that you have properly connected them to the 8300HDC.
- Verify that the volume is turned up (analog audio only).
- Verify that the mute function is not on (analog audio only).

Automatic Software Updates

The TV screen displays a message that indicates the 8300HDC is automatically updating its software. Wait for the current time to display on the front panel of your 8300HDC before continuing. When the front panel displays the time, the update is complete.

Frequently Asked Questions About HDTV

What is Digital Television?

Digital television (DTV) is a huge leap forward in television technology compared to analog television that has been widely available since the 1940s. DTV is delivered and displayed using digital encoding, similar to the way a PC operates. By using digital technology, there is no variation in picture and sound quality from the origination point until it is displayed on your television. You always receive a high-quality picture without the wavy lines or static you might sometimes get from a weak analog signal.

Because DTV receives and displays digital images that contain many times more picture elements (pixels - the small dots that make up the color image on your screen) than standard analog television, you can get a sharper on-screen image than with analog. Additionally, DTV supports CD-quality sound. DTV includes SDTV (Standard Definition Television), EDTV (Enhanced Definition Television), and HDTV (High-Definition Television). That means that all HDTV is digital, but not all digital TV is high-definition. A high-definition program must originate in HD format and be broadcast in HD format. Having an HDTV system does not mean that everything you watch will be in high-definition. Getting the signal from digital cable also does not mean it is high-definition.

What is Standard-Definition Television?

Standard-definition television (SDTV) is basic digital television programming delivered by cable. Typically, the SDTV screen is the same, nearly square shape as an analog television screen. Digital images on an SDTV set are crisp and clear—noticeably better than on a standard analog television set using an antenna to receive over-the-air signals.

What is High-Definition Television?

High-definition television (HDTV) is a completely new way to send and receive television broadcast signals. HDTV images are made up of pixels that are much smaller and closer together than those used in standard analog television, and there are millions of them. Thus, HDTV can display five to six times the detail of analog television to deliver picture quality that is much more realistic, dimensional, and precise. SDTV programs can be viewed on an HDTV. Another feature of HDTV is digital surround sound using Dolby® Digital, which is the same technology used to produce the sound you hear in movie theaters.

Are Local TV Stations Broadcasting in HDTV?

Many local TV stations are transmitting digital signals. However, transmitting a digital signal does not mean transmitting an HDTV signal. Some stations are using the new bandwidth to broadcast several standard-definition channels. Most stations, once they begin broadcasting in digital, are offering HD content from their parent network (for example, CBS, ABC, NBC, Fox, WB, UPN, and PBS).

What is a CableCard?

A CableCard is a multi-stream card that allows the set-top box to decrypt subscription digital channels. The card fits into the CableCard slot on the back of the 8300HDC (see page 3 for the location of the slot). You can obtain a CableCard from your cable service provider.

Where Are the Connection Diagrams?

The diagrams at the end of this guide show examples of common ways to connect the 8300HDC to your HDTV, DVD, and home theater receiver. However, these diagrams do not show every possible combination of devices. Refer to the user's guides that came with your other electronic devices for further information.

What Cables Do I Need?

Some of the cables and adaptors shown in the diagrams may not be included with the 8300HDC. Some of the required cables are shown in the connection diagrams and on page 2 of this guide.

Picture Formats

What is the Difference Between a Standard-Screen and a Wide-Screen HDTV

The type of screen your HDTV has (wide screen or standard screen) determines how the 8300HDC displays programs on the screen. The picture format for an HDTV is a combination of *aspect ratio* and *screen resolution* and is different for standard-screen and wide-screen HDTVs.

What is Aspect Ratio?

An aspect ratio is the ratio of the width to the height of the TV screen. The aspect ratios differ because the television industry manufactures both standard-screen and wide-screen HDTVs to appeal to consumer viewing preferences.

What is the Screen Resolution and Scan Rate?

The screen resolution indicates the amount of detail that the picture displays. Resolution is identified by the number of display lines on the screen. The techniques that an HDTV uses to “paint” the picture on the screen are referred to as progressive and interlaced.



With the **progressive method**, every pixel on the screen is refreshed simultaneously. The **interlace method** involves refreshing pixels in alternation — first the odd lines and then the even lines.

For advance setup, select the scan modes that your TV can support. Refer to your DVR and HDTV user’s guides to choose the proper scan rates (480i, 480p, 720p, 1080i) for your setup.

For example, a resolution of 1080i indicates that the screen shows 1080 lines in an interlaced display, and 480p indicates that the screens shows 480 lines in a progressive display.

Notes:

- The screen resolution (1080i, 480p, and so forth) is sometimes referred to as the scan rate. The terms are interchangeable.
- You can stretch and zoom the displayed picture using the built-in capability of the 8300HDC by pressing the # key on the remote control. Refer to your DVR user’s guide for more information on this feature.

<p>A standard-screen HDTV has a 4x3 aspect ratio. The screen is 4 units wide for every 3 units tall.</p>  <p>A screen resolution of 480p or 480i fills the screen.</p>	<p>A wide-screen HDTV is one-third wider than a standard-screen HDTV. The screen is 16 units wide for every 9 units tall.</p>  <p>A screen resolution of 720p or 1080i fills the screen.</p>
--	---

Connecting the 8300HDC to an HDTV with an HDMI Connector



WARNING:

Electric shock hazard! Unplug all electronic devices before connecting or disconnecting any device cables to the 8300HDC.

Required cables:

- 1 HDMI-to-HDMI cable

Explorer 8300HDC DVR

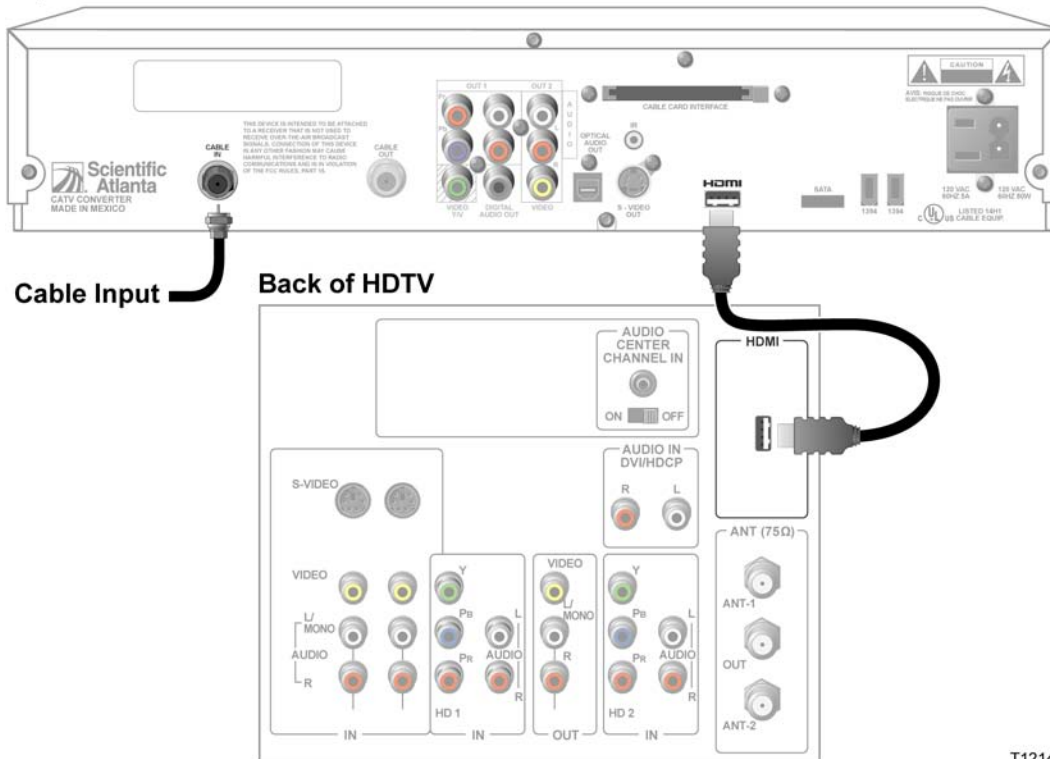

T12143

Important Notes Regarding the HDMI Interface on the 8300HDC

The HDMI interface automatically configures the audio output for a format supported by the television. Because not all TVs support the Dolby® Digital input, the HDMI interface may automatically select a 2-channel stereo audio configuration instead of Dolby Digital, which it carries over to the other digital audio outputs of the 8300HDC. This prevents your home theater system or Dolby Digital decoder from providing the full Dolby Digital surround-sound effect.

You can override this configuration by completing the following steps.

1. Press **SETTINGS** twice on the remote control to open the General Settings menu.
2. Press **MOVE UP** or **MOVE DOWN** to select the option Audio: Digital Out.
3. Press **MOVE RIGHT** to select Dolby Digital. This setting will send Dolby Digital audio to the HDMI, DIGITAL AUDIO OUT, and OPTICAL AUDIO OUT connectors on the 8300HDC.

Notes:

- If the TV is not Dolby Digital capable, it may not produce audio through its speakers when the Audio: Digital Out setting on the 8300HDC is set to Dolby Digital. You can either switch the Audio: Digital Out setting back to HDMI when you are not using the home theater or Dolby Digital decoder, or you can connect the baseband audio outputs (OUT 1 Audio Left and Right) to the TV.
- Digital content is encrypted with High-Bandwidth Content Protection (HDCP) on the DVI/HDMI port. The HDC DVR is not compatible with devices that do not support HDCP. You must use either the YPrPb or 1394 connection to connect the DVR to these devices.

Connecting the 8300HDC to an HDTV with a DVI Connector



WARNING:

Electric shock hazard! Unplug all electronic devices before connecting or disconnecting any device cables to the 8300HDC.

Required cables:

- 1 HDMI-to-DVI or 1 HDMI-to-HDMI cable and 1 DVI adapter
- 1 audio Left/Right cable

Explorer 8300HDC DVR

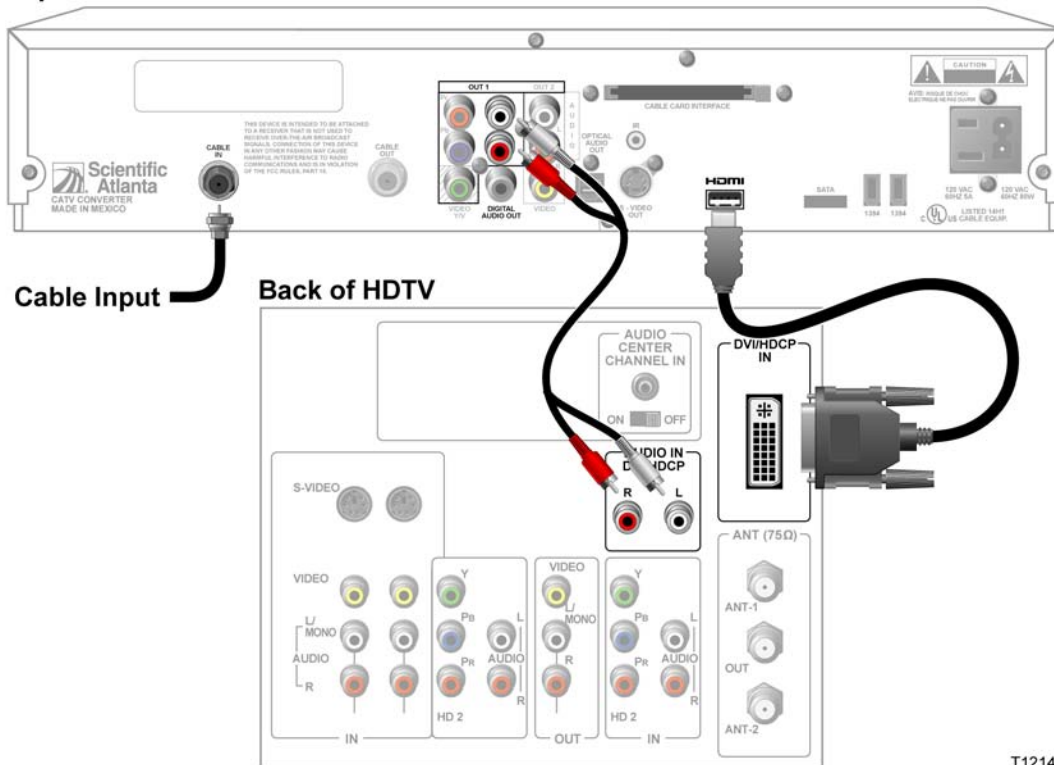

T12144

Notes:

- When you connect the HDMI connector to the DVI connector on your HDTV, you need an HDMI-to-DVI adaptor and a separate audio connection.
- Digital content is encrypted with High-Bandwidth Content Protection (HDCP) on the DVI/HDMI port. The HDC DVR is not compatible with devices that do not support HDCP. You must use either the YPrPb or 1394 connection (which uses Digital Transmission Content Protection, or DTCP) to connect the DVR to these devices.
- Also refer to the **Important Note Regarding the HDMI Interface on the 8300HDC** on page 12.

Connecting the 8300HDC to an HDTV with Component Input (PrPbY/V)



WARNING:

Electric shock hazard! Unplug all electronic devices before connecting or disconnecting any device cables to the 8300HDC.

Required cables:

- 1 set component video cables (PrPbY/V)
- 1 audio Left/Right cable

Explorer 8300HDC DVR

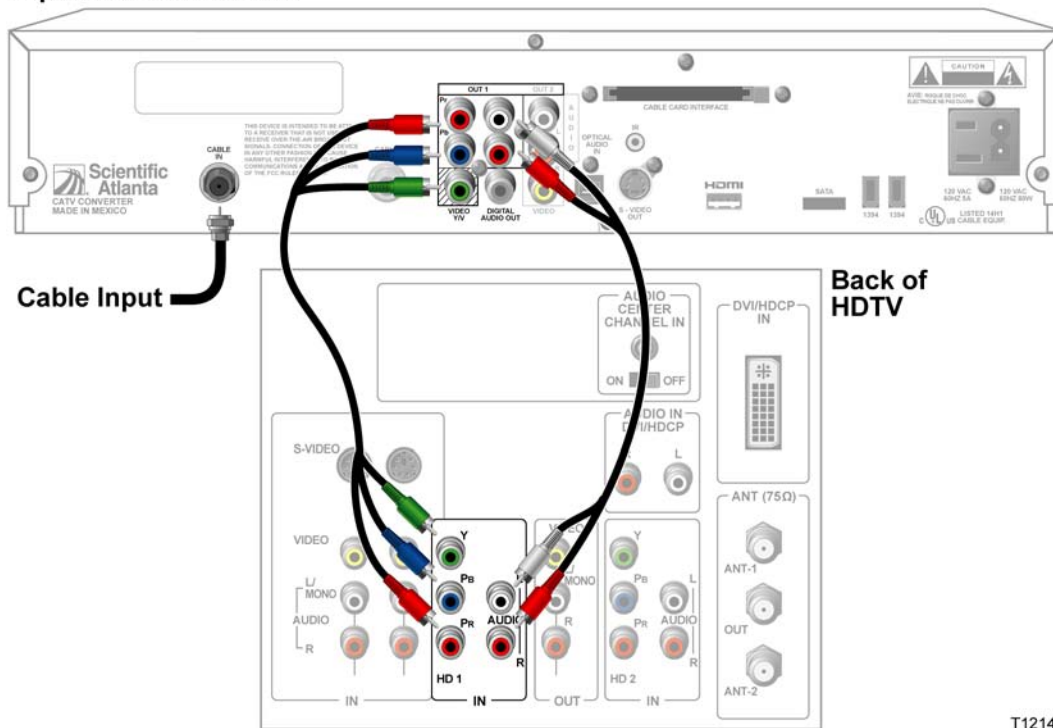

T12145

Connecting the 8300HDC to a Home Theater System with Component Input (PrPbY/V)

Required cables:

- 3 sets component video cables (PrPbY/V)
- 2 coaxial digital audio cables

Explorer 8300HDC DVR

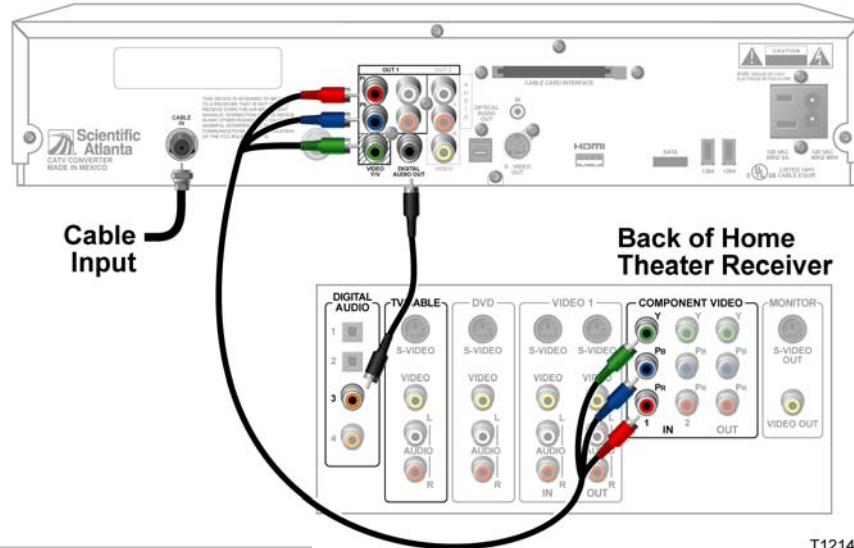

T12146

WARNING:
 Electric shock hazard! Unplug all electronic devices before connecting or disconnecting any device cables to the 8300HDC.

Back of Home Theater Receiver

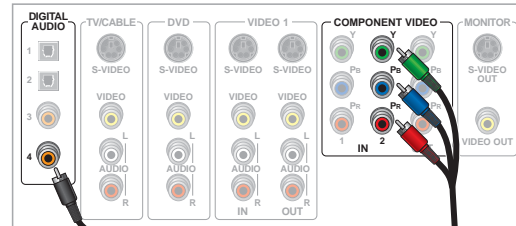

Back of Home Theater Receiver

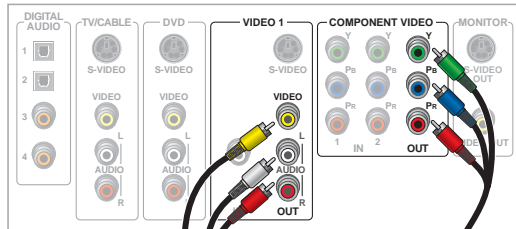

Back of DVD Player

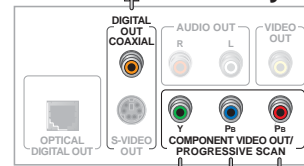

T11135

Back of HDTV

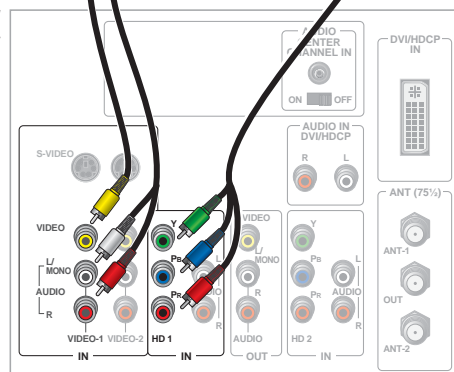

T11136

Note: This connection assumes that audio is provided by the home theater speakers.

Connecting the 8300HDC to a Stereo VCR and HDTV (optional)

 **WARNING:**
Electric shock hazard! Unplug all electronic devices before connecting or disconnecting any device cables to the 8300HDC.

Required cables:

- 1 RF coaxial cable
- 2 sets composite A/V cables

Explorer 8300HDC DVR

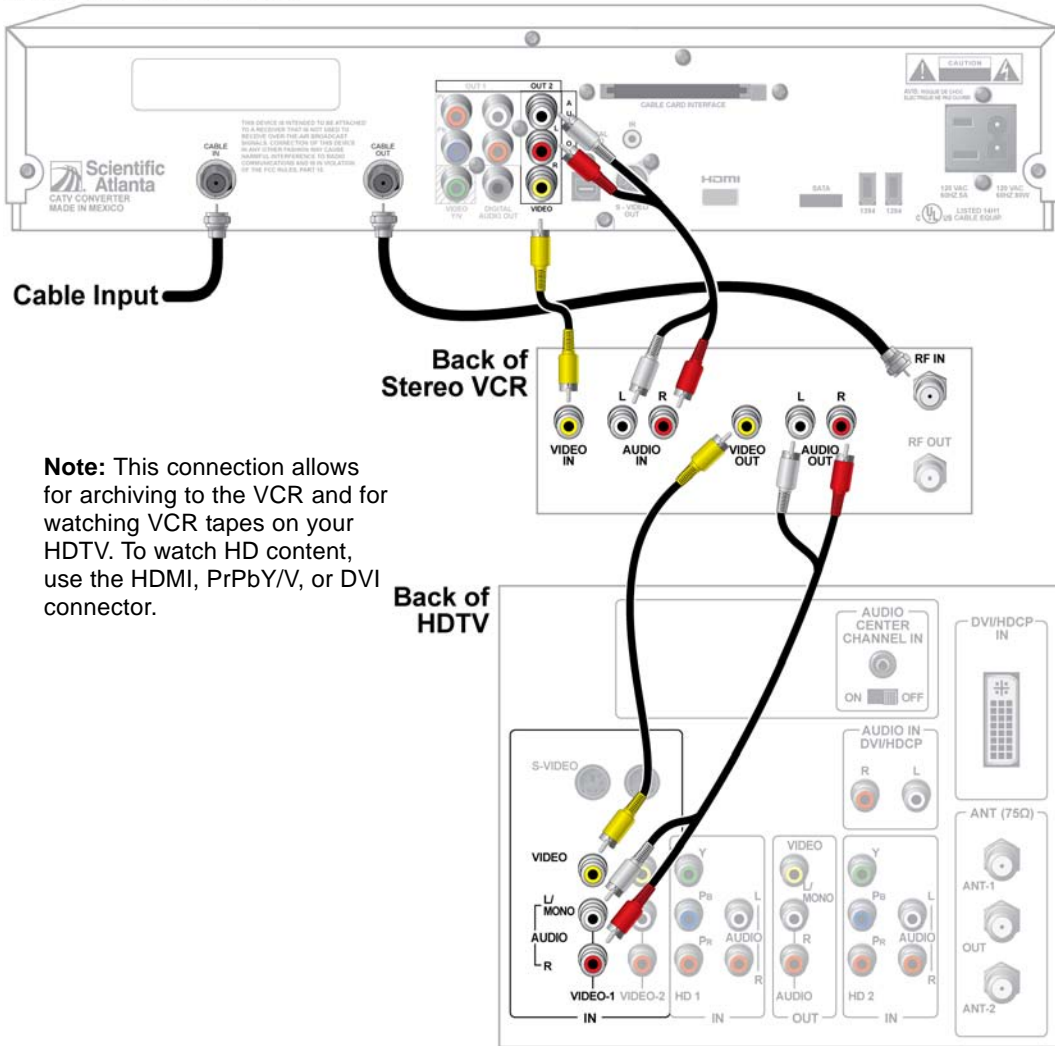

Note: This connection allows for archiving to the VCR and for watching VCR tapes on your HDTV. To watch HD content, use the HDMI, PrPbY/V, or DVI connector.

T12147

Connecting the 8300HDC to an External SATA Hard Disk Drive (optional)

Complete the following steps to install a SATA drive.

1. Make sure that both the 8300HDC and the external SATA drive are unplugged from power.
2. Connect the data cable for the SATA drive to the 8300HDC.
3. Plug in power to the external SATA drive.
4. Plug in the 8300HDC power cord, and then turn on the 8300HDC.
5. Follow the on-screen instructions. One of the following occurs:
 - If it is a new drive or one used on another device, you are asked to format it.
 - If the drive is formatted and will work with this 8300HDC, you get a confirmation that the drive is working.



WARNING:

Electric shock hazard! Unplug all electronic devices before connecting or disconnecting any device cables to the 8300HDC.

Explorer 8300HDC DVR

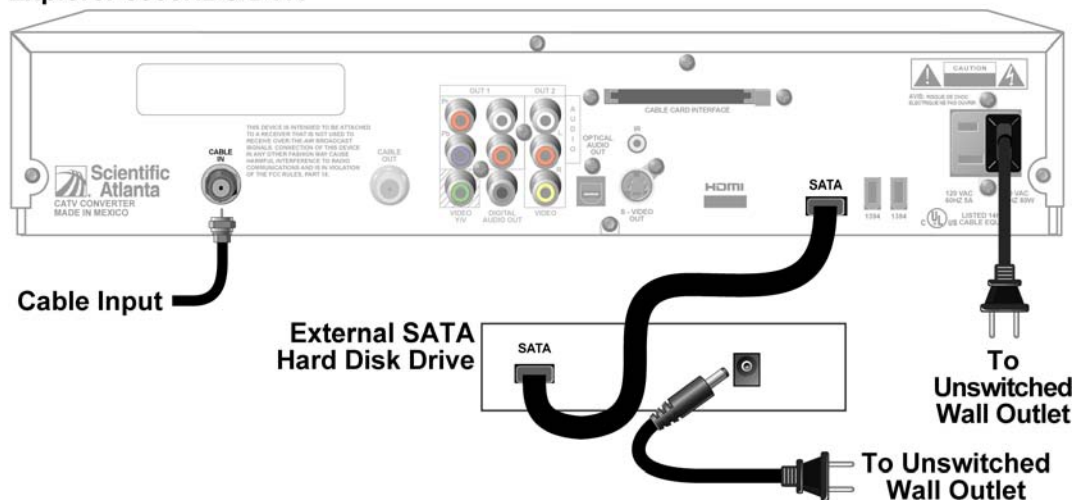

T12148

Guidelines for Using the External SATA Hard Disk Drive

The external SATA hard disk drive requires continuous power. If the SATA drive loses power while the 8300HDC is plugged in, the 8300HDC may stop recording or not provide enough space for future recordings. Follow these guidelines for using the SATA drive:

- Do *not* plug in the power cord for the SATA drive to a switched outlet or to the AC outlet on the 8300HDC.
- Do *not* turn off, disconnect, or unplug the SATA drive while the 8300HDC is plugged in.

Recommendations for the SATA Drive

Contact your cable service provider for a list of approved external SATA hard disk drives. At a minimum, your SATA drive should have these capabilities:

- External SATA Connector - *SATA II: Cable and Connector, Revision 1.0* (www.sata-io.org for more information)
- Drive Speed: 7200 RPM (5400 RPM without Multi-room); 133 MB/sec
- Capacity: Only one SATA drive can be connected to the 8300HDC. The 8300HDC will not support a separate port multiplier.
- SATA Drive Power: The SATA drive should power on when plugged in and should not be controlled by a switch.

Connecting the 8300HDC to an External SATA Hard Disk Drive (optional), continued

How the SATA Drive Works with Your 8300HDC

Recordings are balanced between the internal hard drive on the 8300HDC and the external SATA drive as follows:

- A recording is not split between an internal and external hard drive.
- The 8300HDC automatically stores complete programs using the following space available logic:
 - If the external SATA drive has more space available, the SATA drive stores the next recording.
 - If the internal hard drive on the 8300HDC has more space available, the internal hard drive stores the next recording.

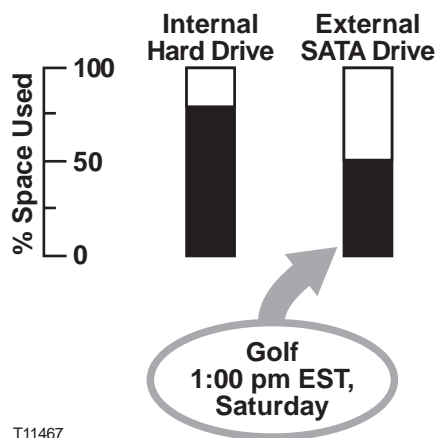

T11467

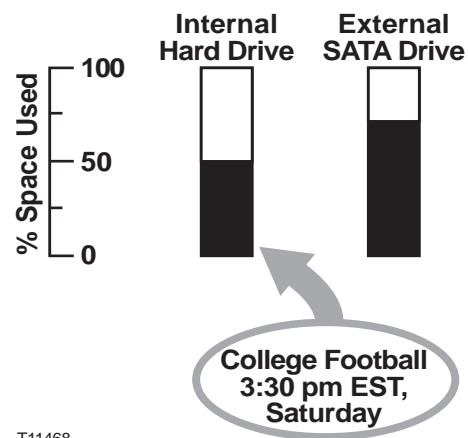

T11468

Disconnecting the External SATA Hard Disk Drive

Complete the following steps to disconnect the SATA drive safely.

1. Make sure that the 8300HDC is powered off.
2. Disconnect the power cord from the 8300HDC and wait for at least 10 seconds.
3. Disconnect the power cord and data cable from the external SATA drive.

Note: If you improperly disconnect your SATA drive, you will receive an error message, and you will be required to restart the 8300HDC upon reconnecting.

Connecting the 8300HDC to an HDTV with a 1394 Connector

Required cables:

- 1 6-pin to 4-pin 1394 cable (Consult your TV user's guides for more detailed information)
- 1 set composite A/V cables
- 1 set audio Left/Right cables

Explorer 8300HDC DVR

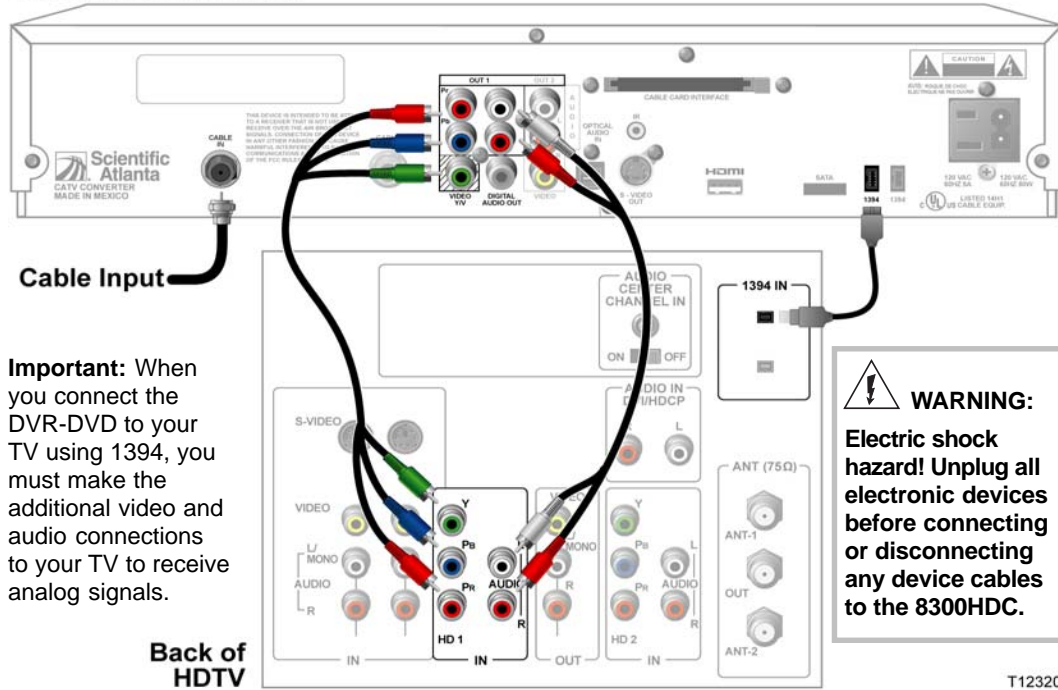

Connecting the 8300HDC in HD Mode to an SDTV with Component Input (PrPbY/V)

WARNING:
Electric shock hazard! Unplug all electronic devices before connecting or disconnecting any device cables to the 8300HDC.

Explorer 8300HDC DVR Set to HD Mode

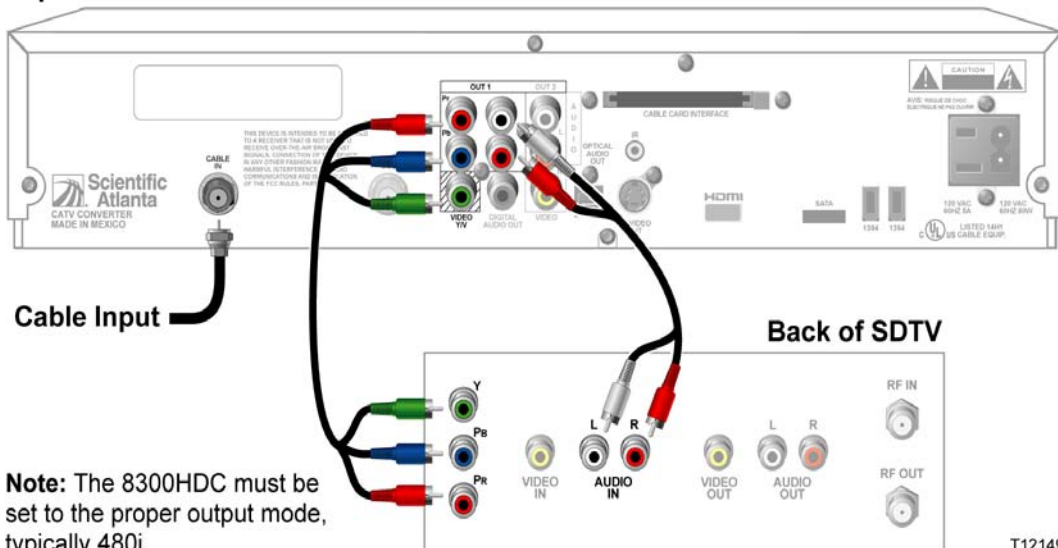

Compliance Information

United States FCC Compliance

This equipment has been tested and found to comply with the applicable limits of Part 15 of the FCC Rules. These limits are designed to provide reasonable protection against harmful interference in a residential installation. This equipment generates, uses, and can radiate radio frequency energy and, if not installed and used in accordance with the instructions, may cause harmful interference to radio or TV reception, which can be determined by turning the equipment off and on. The user is encouraged to try to correct the interference by one or more of the following measures:

- Increase the separation between the equipment and receiver
- Connect the equipment into an outlet on a circuit different from that to which the receiver is connected
- Consult your cable company or an experienced radio/TV technician for help

Any changes or modifications not expressly approved by Scientific Atlanta could void the user's authority to operate the equipment.

Important: The information shown in the FCC Declaration of Conformity paragraph below is a requirement of the FCC and is intended to supply you with information regarding the FCC approval of this device. *The phone numbers listed are for FCC-related questions only and not intended for questions regarding the connection or operation for this device. Please contact your cable service provider for any questions you may have regarding the operation or installation of this device.*

FCC Declaration of Conformity

This device complies with *Part 15 of the FCC Rules*. Operation is subject to the following two conditions:

- 1) this device may not cause harmful interference, and
- 2) this device must accept any interference received, including interference that may cause undesired operation.

EXPLORER® 8300HDC
Digital Video Recorder:
Model 8300HDC
Manufactured by: Scientific-Atlanta, Inc.;
5030 Sugarloaf Parkway;
Lawrenceville, Georgia 30044; USA
Telephone **770-236-1077**

Canada EMI Regulation

This Class B digital apparatus complies with Canadian ICES-003.

Cet appareil numérique de la class B est conforme à la norme NMB-003 du Canada.

Software and Firmware Use

Scientific-Atlanta, Inc. owns copyrights to the software included in your set-top and furnishes the software to your cable service provider under a license agreement. You may only use or copy this software in accordance with the terms of your cable service provider.

Scientific-Atlanta, Inc. owns copyrights to the firmware in this equipment. You may only use the firmware in the equipment in which it is provided. Any reproduction or distribution of this firmware, or any portion of it, without the express written consent of Scientific-Atlanta, Inc. is prohibited.

Trademarks

Scientific Atlanta, the Scientific Atlanta logo, and Explorer are registered trademarks of Scientific-Atlanta, Inc. 8300HDC is a trademark of Scientific-Atlanta, Inc. Dolby is a registered trademark of Dolby Laboratories. HDMI, the HDMI logo, and High-Definition Multimedia Interface are trademarks or registered trademarks of HDMI Licensing LLC. CableCARD is a trademark of Cable Television Laboratories, Inc. All other trademarks shown are trademarks of their respective owners.

Disclaimer

Scientific-Atlanta, Inc. assumes no responsibility for errors or omissions that may appear in this guide. Scientific-Atlanta, Inc. reserves the right to change this guide at any time without notice.

Index

1394 Firewire 4, 6, 19

A

AC

Outlet iv, 4, 17

Power input 4

Aspect ratio 11

B

Back panel 4

Burn-in of screen 8

C

CableCard 2, 4, 10

Cables 2

Cable Out, connector 4

Compliance, FCC and Canadian EMI 20

Component video connection. *See* PrPbY/V

Composite 7

Connectors

See also Front panel; Back panel

required for HDTV 6

required for SDTV 7

VCR 6, 7

Connecting the 8300HDC to other devices;
Explorer eClub

HDTV with 1394 connector 19

HDTV with component input (PrPbY/V) 14

HDTV with DVI connector 13

HDTV with HDMI connector 12

HDTV with VCR 16

Home Theater System with component input
(PrPbY/V) 15

SATA drive, external 17, 18

SDTV 19

Controls. *See* Front panel

D

Dashes display 5

Diagrams. *See* Connecting the 8300HDC
to other devices

Digital Video Recorder. *See* DVR, What is it?

Digital TV, What is it 10

Display, LED 3

DVI connector 2, 4, 6, 13

DVR, What is it 1

E

Explorer eClub 1

External hard disk drive. *See* SATA

F

FAQs 10

FCC compliance 20

Formats, picture 11

Frequently Asked Questions. *See* FAQs

Front panel 3

H

Hard disk drive, external. *See* SATA

HD

broadcasting 10

mode 4, 5, 6, 7, 19

format 2, 10

HDTV

Connections 6

formats 11

What is it 10

HDMI 4, 6, 12

High-definition. *See* HD

Home theater system connection 15

I

Interlaced scan rate 11

IR Sensor 3

K

Keys. *See* Front panel; Back panel

L

LED Display 3

Index, continued

M

Multi-stream CableCARD 2, 4, 10

P

Performance tips. See Troubleshooting.

Picture

Doesn't display 9

Formats 11

No color 9

Picture-in-picture. See PIP

PIP 8

Ports. See Connectors

Product information. See Explorer eClub

Programming, viewing 8

Progressive scan rate 11

PrPbY/V

connector 4, 6, 7

HDTV connection 14

home theater connection 15

SDTV connection 19

R

Record programs 1, 8

Remote control 8

RGB connector. See PrPbY/V

S

S-Video 7

Safety ii, iv-v

SATA 4, 17-18

Scan rates 11

Screen

burn-in 8

resolution 11

size 11

SD mode 4, 5, 7, 19

SDTV

Connections 7, 19

What is it 10

Serial number, locating 1

Set-top. See Welcome

Software updates 9

Sound, troubleshooting 9

Standard-definition, What is it 10

Standard screen TV 11

Stretching and zooming picture 11

T

Time display 5

Troubleshooting 9

TV

digital, what is it 10

formats 11

HDTV, what is it 10

programming 8

recording 1, 8

resolution 11

standard screen 11

standard-definition, what is it 10

wide screen 11

U

Updating, software 9

USB port 3

V

VCR connection 6, 7, 16

View programs 8

W

Watch TV 1, 8

Web access to product information. See Explorer eClub

Welcome 1

Widescreen TV 11

Y

YPbPr. See PrPbY/V

Y/V PbPr. See PrPbY/V

Z

Zoom picture 11



© 2006 by Scientific-Atlanta, Inc. All rights reserved.

Product and service availability subject to change without notice.

Scientific Atlanta, A Cisco Company, 5030 Sugarloaf Parkway, Box 465447,
Lawrenceville, GA 30044

www.scientificatlanta.com

March 2006 Printed in USA

4013171 Rev A

Free Manuals Download Website

<http://myh66.com>

<http://usermanuals.us>

<http://www.somanuals.com>

<http://www.4manuals.cc>

<http://www.manual-lib.com>

<http://www.404manual.com>

<http://www.luxmanual.com>

<http://aubethermostatmanual.com>

Golf course search by state

<http://golfingnear.com>

Email search by domain

<http://emailbydomain.com>

Auto manuals search

<http://auto.somanuals.com>

TV manuals search

<http://tv.somanuals.com>