

---

# Connecting the Explorer<sup>®</sup> 8300HD<sup>™</sup> Digital Video Recorder





# Contents









Important Safety Instructions .....	iv
Change the Way You Watch TV .....	1
Safety First .....	1
The Explorer eClub .....	1
Identify Your 8300HD .....	1
What's On the Front Panel? .....	2
What's On the Back Panel? .....	3
Connecting the 8300HD .....	4
Connections for an HDTV and VCR .....	5
Connections for a Standard-Definition TV and VCR .....	6
Watch TV .....	7
Performance Tips .....	8
Frequently Asked Questions About HDTV .....	9
Picture Formats .....	10
Connecting the 8300HD to an HDTV With an HDMI Connector .....	11
Connecting the 8300HD to an HDTV With a DVI Connector .....	12
Connecting the 8300HD to an HDTV With Component Input (PrPbY/V) .....	13
Connecting the 8300HD to a Home Theater System With Component Input (PrPbY/V) .....	14
Connecting the 8300HD to a Stereo VCR and HDTV (optional) .....	15
Connecting the 8300HD to an External SATA Hard Disk Drive (optional) .....	16
Connecting the 8300HD in HD Mode to an SDTV With Component Input (PrPbY/V) .....	18
Connecting the 8300HD in SD Mode to an SDTV .....	18
Compliance Information .....	19
Index .....	20

# IMPORTANT SAFETY INSTRUCTIONS

## Heed Warnings

### Notice for CATV Installers

If you are a CATV installer, read the information in the box below.

<p><b>Note to CATV System Installer (USA/Canada Only)</b></p> <p>This reminder is provided to call the CATV system installer's attention to Article 820-40 of the NEC (Section 54, Part I of the Canadian Electrical Code), that provides guidelines for proper grounding and, in particular, specifies that the CATV cable ground shall be connected to the grounding system of the building, as close to the point of cable entry as practical.</p>	<table border="1"><tr><td></td><td><b>CAUTION</b> RISK OF ELECTRIC SHOCK DO NOT OPEN</td><td></td></tr><tr><td></td><td><b>AVIS</b> RISQUE DE CHOC ÉLECTRIQUE NE PAS OUVRIR</td><td></td></tr></table>		<b>CAUTION</b> RISK OF ELECTRIC SHOCK DO NOT OPEN			<b>AVIS</b> RISQUE DE CHOC ÉLECTRIQUE NE PAS OUVRIR	
	<b>CAUTION</b> RISK OF ELECTRIC SHOCK DO NOT OPEN						
	<b>AVIS</b> RISQUE DE CHOC ÉLECTRIQUE NE PAS OUVRIR						
 <p>This symbol is intended to alert you that uninsulated voltage within this product may have sufficient magnitude to cause electric shock. Therefore, it is dangerous to make any kind of contact with any inside part of this product.</p>	<p>CAUTION: To reduce the risk of electric shock, do not remove cover (or back). No user-serviceable parts inside. Refer servicing to qualified service personnel.</p> <p>WARNING TO PREVENT FIRE OR ELECTRIC SHOCK, DO NOT EXPOSE THIS UNIT TO RAIN OR MOISTURE.</p>  <p>This symbol is intended to alert you of the presence of important operating and maintenance (servicing) instructions in the literature accompanying this product.</p>						

## Comply With Warnings

Avoid electric shock. Comply with all warnings and cautions in the operating instructions, as well as those that are affixed to this product.

## Read, Retain, and Follow These Instructions

Read all of the instructions before you operate this product. Follow all operating instructions that accompany this product. Retain the instructions for future use. Give particular attention to all safety precautions.

## Power Warnings

### Providing a Power Source

A label on this product indicates the correct power source for this product. Operate this product only from an electrical outlet with the voltage and frequency indicated on the product label.

If you are uncertain of the type of power supply to your home or business, consult your cable service provider or your local power company.

	<b>WARNING:</b> Avoid electric shock and fire hazard! Do not overload mains AC outlets and extension cords. For products that require battery power or other power sources to operate them, refer to the operating instructions for those products.
---	--

## Grounding This Product

This product is equipped with either a three-prong (grounding pin) safety plug or a two-prong (polarized) safety plug. To properly ground this product, follow these safety guidelines:

- For a 3-prong plug (one prong on this plug is a protective grounding pin), insert the plug into a grounded mains, 3-prong outlet. **Note:** This plug fits only one way. If you are unable to insert this plug fully into the outlet, contact your electrician to replace your obsolete outlet.
- For a 2-prong plug (a polarized plug with one wide blade and one narrow blade), insert the plug into a polarized mains, 2-prong outlet in which one socket is wider than the other. **Note:** If you are unable to insert this plug fully into the outlet, try reversing the plug. If the plug still fails to fit, contact an electrician to replace your obsolete outlet.

	<b>WARNING:</b> To avoid electric shock and fire hazard, match the plug and outlet connections carefully, then fully insert. If the plug and outlet do not match, or you cannot fully insert the plug, contact an electrician to update your power outlets.
---	--

## Overloading

Do not overload electrical outlets, extension cords, or integral convenience receptacles as this can result in a risk of fire or electric shock. For products that require battery power or other sources to operate, refer to the operating instructions for that product.

## Preventing Power Cord Damage

Arrange all power cords so that people or pets cannot walk on the cords. Do not place objects on the cords. Do not lean objects against the cords. Placing objects on or leaning objects against cords can damage the cords. Give particular attention to cords at the point at which the cord connects to plugs, at the electrical outlets, and where the cords exit the product.

## Protecting Against Power Surges

To protect this product from power surge damage, ground (earth) your cable product to provide some protection against voltage surges and built-up static charges. To avoid these voltage surges that can be caused by lightning storms and power outages, do the following:

- Plug this product into a surge protector in order to reduce the risk of damage.
- Ground your antenna system, if applicable, to provide some protection against voltage surges and a built-up static charge.

## Usage Warnings

### Providing Ventilation

This product has openings for ventilation that protect it from overheating. To ensure the reliability of this product, do the following:

- Do not block or cover these openings.
- Do not place entertainment devices (such as VCRs or DVDs), lamps, books, vases with liquids, or other objects on top of this product.
- Do not place this product in any of the following locations:
  - On a bed, sofa, rug, or similar surface
  - Over a radiator or heat register
  - In an enclosure, such as a bookcase or rack, unless the installation provides proper ventilation

### Selecting a Proper Location

Place this product in a location that is close enough to an electrical outlet and where the power cord is easily accessible to be disconnected from the wall outlet or from the rear panel of the product.

**Important:** The power cord is the mains power supply disconnect device.

Place this product on a stable surface. The surface must support the size and weight of this product.



#### WARNING:

Avoid personal injury and damage to this product!  
An unstable surface may cause this product to fall.

## Cleaning This Product

Before cleaning this product, unplug it from the electrical outlet. Use a damp cloth to clean this product. Do not use a liquid cleaner or an aerosol cleaner. Do not use a magnetic/static cleaning device (dust remover) to clean this product.

## Protecting This Product From Foreign Objects and Water or Moisture Damage

Never push objects of any kind into this product through openings as they may touch dangerous voltage points or short out parts that could result in a fire or electric shock.

Do not expose this product to liquids or moisture. Do not place this product on a wet surface. Do not spill liquids on or near this product.



#### WARNING:

Avoid electric shock and fire hazard! Never push objects through the openings in this product. Foreign objects can cause electrical shorts that can result in electric shock or fire. Do not expose this product to rain or moisture. Do not place objects filled with liquid, such as vases, on this product.

## Accessories

Do not use accessories with this product unless recommended by your cable service provider.

To protect this product from damage due to interference of other electronic devices, or to connect this product to additional devices, heed the instructions in the following warnings.



#### WARNING:

Maintain electrical safety! Power-operated devices that you connect to this product should bear the UL listing mark or CSA certification mark on the device itself. Do not modify the device. Any modifications to this device may defeat this product or the device's safety features that help to avoid any potential for electric shock or fire. If in doubt about any modifications to this device, contact qualified service personnel.



#### WARNING:

Use this product only with a cart, stand, bracket, table, or other mounting accessories that meet Scientific-Atlanta specification. Carefully follow all instructions for proper mounting.

## Service Warnings

### Servicing This Product

Do not open the cover of this product. If you open the cover, your warranty will be void. Refer all servicing to qualified personnel only. Contact your cable service provider for instructions.



#### WARNING:

Avoid electric shock! Opening or removing the cover may expose you to dangerous voltages. Perform only the servicing instructions included in the operating instructions. Refer all servicing to qualified service personnel.

Upon completion of any service or repairs to this product, the service technician must perform safety checks to determine that this product is in proper operating condition.

### Obtaining Service for Product Damage

For damage that requires service, unplug this product from the AC outlet. Then, contact your cable service provider or qualified service personnel to obtain service for the following conditions:

- If there is damage to the power-supply cord or plug
- If liquid enters this product
- If you expose this product to rain or water
- If you drop this product, a heavy object falls on this product, or damage occurs to the cover of this product
- If this product does not operate normally by following the operating instructions
- If this product exhibits a distinct change in performance



# Change the Way You Watch TV

## DVR makes it easy to watch TV on your terms.

The Explorer 8300HD Digital Video Recorder (DVR) is the simple way to take control over your TV – and your life. You take control because DVR lets you decide what's on TV and when. So there's no more putting off the things you need to do, just because there's a show on TV you want to watch. Just think what DVR can do for you:

- Never miss a minute of your favorite movie or the big game. Simply pause the live action and play again when you're ready. You can even rewind what you missed.
- Two of your favorite shows on at the same time? Simple. Just record one program while you watch the other. You can even record two programs at the same time while watching a previously recorded program. Your VCR can't do that.
- Is your favorite sports team having an away game and you can't go? Imagine being able to record it and watch it in High Definition (HD) at a more convenient time. In HD, the picture is so clear you'll almost forget that you're not there.

## Don't miss another minute of the TV shows you love!

Follow the instructions in this guide to install the 8300HD to become familiar with the buttons on the front panel, and to access your cable services. Then, enjoy the features of the 8300HD and change the way you watch TV!

## Safety First

Before using the 8300HD, read the Important Rules for Safe Operation section of this guide.

## The Explorer eClub

The online Explorer eClub provides news and information about the Explorer 8300HD DVR. You can access the Explorer eClub on the Internet at the following Web address:

[www.scientificatlanta.com/explorerclub](http://www.scientificatlanta.com/explorerclub)

To join and access the online Explorer eClub, you need to enter the model number of your 8300HD. The model number is on the label on the bottom of the 8300HD.

## Identify Your 8300HD

To find the serial number for your 8300HD, look on the back for a label that is similar to the example shown here. The serial number begins with "SA" and is located in the lower left corner of the bar code.

If the 8300HD requires troubleshooting in the future, your cable service provider may ask for this serial number.

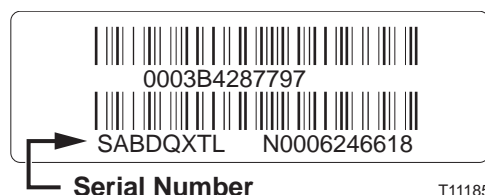

Use the space provided here to record the serial number:

---

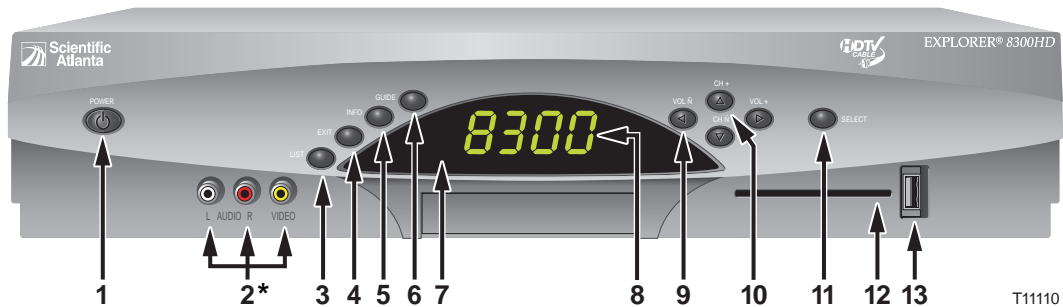

## What's On the Front Panel?



- |                                 |  |
|---------------------------------|--|
| <b>1 Power</b>                  | Turns the 8300HD on and off  |
| <b>2 Video and Audio Input*</b> | Connects to video and left/right (L/R) audio outputs of an external device to deliver the audio and video to a TV or other device  |
| <b>3 List</b>                   | Displays the list of recorded programs   |
| <b>4 Exit</b>                   | Exits menus, the on-screen guide, and program information  |
| <b>5 Info</b>                   | Displays a description of the selected program. This button is available from the on-screen guide and while viewing a program  |
| <b>6 Guide</b>                  | Accesses on-screen services, such as the on-screen guide, video-on-demand, or pay-per-view   |
| <b>7 IR Sensor</b>              | Receives the infrared signal from the remote control   |
| <b>8 LED Display</b>            | Displays the selected channel number and time of day. The LED also displays the following: <ul style="list-style-type: none"> <li>• Message (  )</li> <li>• HDTV</li> <li>• Power (  )</li> <li>• Output Resolution (1080i, 720p, 480p, 480i)</li> <li>• RECORD</li> <li>• AUTO - Automatically outputs native scan rates that your TV can accept</li> </ul> |
| <b>9 VOL + and VOL -</b>        | Enables you to increase and decrease the volume  |
| <b>10 CH + and CH -</b>         | Enables you to scroll up and down through the channels   |
| <b>11 Select</b>                | Provides access to your on-screen selection  |
| <b>12 Smart Card*</b>           | Allows smart card access   |
| <b>13 USB Port*</b>             | Connects to external equipment, such as a keyboard   |

\* These connectors are reserved for future use or may not be available on all 8300HD models.



# What's On the Back Panel?

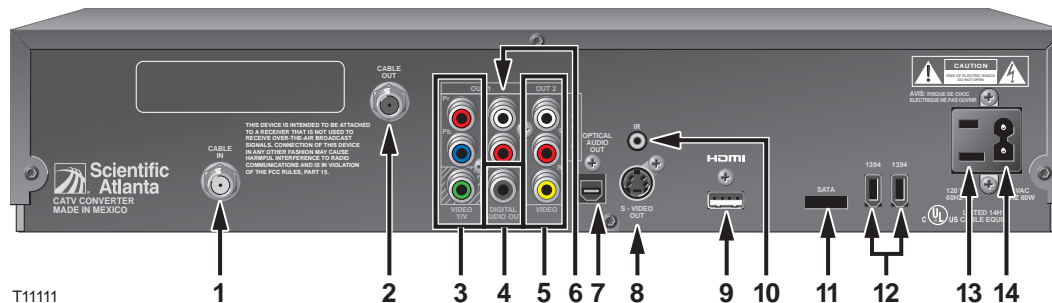

T11111

- 1 Cable In**                      Connect the coaxial cable that delivers the signal from your cable service provider
- 2 Cable Out**                     Connect a coaxial cable to Cable Out to send analog audio and video signals to a TV or VCR. These signals are standard-definition TV (SDTV) video and stereo audio
- 3 PrPbY/V**                        Connect the 8300HD (when in **HD mode**) to the component video input (YPrPb) on the HDTV. When the 8300HD is configured for **SD mode**, the Y/V portion of the component video output connects to the composite video input of an HDTV or SDTV. See **Connections for an HDTV and VCR** or **Connections for a Standard-Definition TV and VCR**, later in this guide, for complete details
- 4 Digital Audio Output**            Connect an RCA cable to send a digital audio signal to a surround-sound receiver or other digital audio device
- 5 Secondary Video and Audio Out**    Connect to either a VCR for archiving saved content from the 8300HD or connect to another set of inputs (composite) on your HDTV
- 6 Audio Out (LEFT and RIGHT)**    Connect RCA cables to Audio Out to send analog audio signals (left and right) to a TV with stereo outputs
- 7 Optical Audio Output**            Connect an optical cable to send a digital audio signal to a surround-sound receiver or other digital audio device
- 8 S-Video Out**                     Connect an S-Video cable to send an S-Video signal to your TV or VCR. This signal is standard definition but higher quality than other SDTV connections
- 9 HDMI**                              Connect the HDTV HDMI™ connector to the HDMI port. HDMI supports both digital audio and video. May be used to connect to a DVI interface using an adaptor
- 10 IR**                                 (This connector reserved for future use.)
- 11 SATA**                             Connect to an external Serial ATA (SATA) hard disk drive for expanded recording capacity. Check with your cable service provider for a list of approved hard drive models for use with the 8300HD
- 12 1394 Firewire**                  Connect to display devices equipped with a 1394 input. This connector is reserved for future use and may not be available on all 8300HD models
- 13 AC Outlet**                        Connect the AC power cord from another device, such as a TV
- 14 AC Power Input**                Connect the power cord to deliver power to the 8300HD

# Connecting the 8300HD

To connect your 8300HD to your entertainment devices, complete these steps.



Determine if your TV is HD or SD and whether it is wide screen (16:9) or standard screen (4:3). **See page 10** for more information.



or

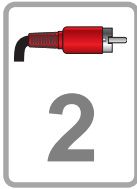

Make the connections for your TV and VCR as follows:

- If you are using an HDTV, **see page 5** and the connection diagrams at the end of this guide.
- If you are using an SDTV, **see page 6** and the connection diagrams at the end of this guide.
- If you want to archive some programs to VCR tape, **see pages 5 and 6** and the connection diagrams at the end of this guide.



Identify the additional devices you will connect to the 8300HD and TV. **See pages 11 through 18** and the related user guides for more information.

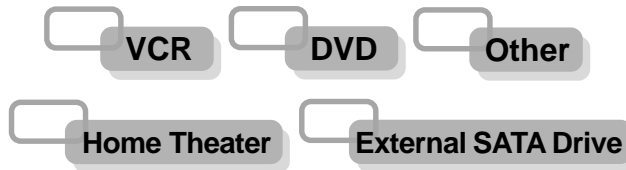

Plug the 8300HD and the TV into an AC power source that is not controlled by a switch.



Do not turn on the 8300HD or TV yet.



It may take several minutes for the 8300HD to receive the latest software, programming, and service information. Wait until you see one of the following displays on the front panel of the 8300HD that indicates that the update is complete:

- Current time
- Four dashes (- - - -)

**Note:** If four dashes are displayed, you must call your cable service provider to get the 8300HD authorized.



































Set up your 8300HD for HDTV or SDTV by completing the following steps:

- Make sure the 8300HD is **Off** and the TV is **On**.
- On the front panel of the 8300HD, press **GUIDE** and **INFO** at the same time.
- Follow the on-screen instructions to choose **HD** or **SD** mode and wide screen (16:9) or standard screen (4:3) depending upon your TV type. **See Page 10** for more information on the scan rate.
- At the conclusion of the on-screen instructions, press **POWER** on the 8300HD to begin watching TV.

# Connections for an HDTV and VCR

To use the 8300HD with an HDTV, you must make *one* of the following connections to view the HD content. In addition, you can make connections to a VCR to archive recordings to a VCR tape. Refer to your TV and VCR user's guide and the cabling diagrams in this guide for more detailed connection information.











**Note:** The labeling on your 8300HD may vary slightly.

Required Connections to an HDTV (use one)		8300HD Connections	HDTV Connections
HDMI	Some HDTVs have a High-Definition Multimedia Interface (HDMI) connector. The HDMI connector provides both a digital video and audio connection. See the connection diagram on page 11 for an example.	HDMI 	HDMI 
DVI	The HDMI connector can provide the connection to an HDTV with a DVI input. If your HDTV has a Digital Visual Interface (DVI) connector, you will need an HDMI-to-DVI adaptor, and you will need to connect a separate audio connection. See the connection diagram on page 12 for an example.	HDMI  OUT 1 L R  <b>Adaptor Needed</b>	DVI  L R 
PrPbY/V	The PrPbY/V connectors can provide high-definition component video signals to an HDTV. <b>Note:</b> You can use the HD Setup Wizard on the 8300HD to set the HD mode and select the output video format (480i, 480p, 720p, 1080i) that will match the full capabilities of your HDTV. See the connection diagram on page 13 for an example.	Pr  Pb   VIDEO Y/V OUT 1 L R 	Y  Pb  Pr  L R 
RGB	Some HDTVs have only RGB connectors. If you have one of these HDTVs, you need an RGB adaptor. Check with your cable service provider for information about acquiring an RGB adaptor, or you can purchase the adaptor at your local electronics supplier.	Pr  Pb   VIDEO Y/V OUT 1 L R  <b>Adaptor Needed</b>	R  G  B  H  V  L R 
Optional Connections to a VCR (use one)		8300HD Connections	VCR Connections
VCR	For VCRs that have a Video and Left and Right audio connectors, you can use the Out 2 connectors (Video, Left, and Right) on the 8300HD. See the connection diagram on page 15 for an example.	OUT 2 L R  VIDEO 	VIDEO IN  L R  AUDIO IN
	For VCRs that have an S-Video and Left and Right audio connectors, you can use the S-Video Out and the Out 2 Left and Right connectors on the 8300HD.	S-VIDEO OUT  OUT 2 L R 	S-VIDEO IN  L R 

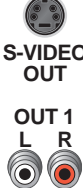
# Connections for a Standard-Definition TV and VCR

When using the 8300HD with an SDTV, you must make *one* of the following connections to view content. Some SDTVs may not have all these connections. In addition, you can make connections to a VCR to archive recordings to a VCR tape. Refer to your TV and VCR user guides and the cabling diagrams in this guide for more detailed information.

**Note:** The labeling on your 8300HD may vary slightly.

Required Connections to an SDTV (use one)		8300HD Connections	SDTV Connections
PrPbY/V	<p>The PrPbY/V connectors can provide standard-definition component video signals to an SDTV.</p> <p><b>Note:</b> To connect PrPbY/V to an SDTV, you must set the HD Setup Wizard on the 8300HD to <b>HD Mode</b>, and select the output video format (typically only 480i) that will match the capabilities of your SDTV.</p> <p>See the connection diagram on page 18 for an example.</p>		
Composite	<p>When you set up the 8300HD in <b>SD mode</b>, the Y/V connector on the 8300HD is configured as a composite video out connector (V).</p> <p>See the connection diagram on page 18 for an example.</p>		
S-Video	<p>The S-Video Out connection provides an optimal video connection to SDTVs.</p>		
Cable Out	<p>The Cable Out connector provides a video and audio connection to an SDTV.</p>		
Optional Connection to a VCR		8300HD Connections	VCR Connections
VCR	<p>For VCRs that have a Video and Left and Right Audio connectors, you can use the Out 2 connectors (Video, Left, and Right) on the 8300HD.</p>		

# Watch TV

## Access Services and Programs

Access cable services and programs by pressing the following keys on the remote control:

- **Guide**—Access the on-screen guide. The on-screen guide displays schedules of TV programs and other services available from your cable service provider, such as video-on-demand and pay-per-view programs.
- **Arrows**—Select a program in the schedule.
- **Info**—Display a specific program description (either from the on-screen guide or while viewing a program).
- **Select**—View a specific program in the guide.



## Record One Program While Watching Another

When two of your favorite programs are scheduled at the same time, you can record one program on the built-in DVR while watching the other. Use the DVR keys on the remote control to record programs or to play back recorded programs.

## Watch Two Programs at the Same Time

You do not need a special TV to watch two programs at the same time. Use the picture-in-picture (PIP) keys on the remote control, and you will see a PIP screen on your TV.



## Stretch and Zoom Program

You can stretch and zoom SD or HD programs by pressing the # key on the remote control.

## Avoid Screen Burn-In!

Images such as letterbox bars or side bars, bright closed-captioning backgrounds, station logos, or any other stationary images may cause the picture tube in your HDTV to age unevenly; this is known as screen burn-in. Refer to the user's guide that came with your HDTV for more information.



**WARNING:**  
**Avoid screen burn-in!**  
**Do not display the same fixed images on your HDTV screen for extended periods of time.**

## Performance Tips

If the 8300HD does not perform as expected, the following tips may help. If you need further assistance, contact your cable service provider.

### No Picture

- Verify that the power to your TV is turned on.
- If the 8300HD is plugged into a wall switch, verify that the switch is in the ON position.
- Verify that all cables are properly connected.
- If your system includes a VCR or stereo, verify that you have properly connected them to the 8300HD.
- Verify that the 8300HD is set to the proper screen type and resolution.

### No Color

- Verify that the current TV program is broadcast in color.
- Adjust the TV color controls.
- If you are using a component video connection (PrPbY/V), check that all connectors are completely plugged into the 8300HD and TV.

### No Sound

- If your setup includes a VCR or stereo, verify that you have properly connected them to the 8300HD.
- Verify that the volume is turned up.
- Verify that the mute function is not on.

### Automatic Software Updates

The TV screen displays a message that indicates the 8300HD is automatically updating its software. Wait for the current time to display on the front panel of your 8300HD before continuing. When the front panel displays the time, the update is complete.

# Frequently Asked Questions About HDTV

## What is Digital Television?

Digital television (DTV) is a huge leap forward in television technology compared to analog television that has been widely available since the 1940s. DTV is delivered and displayed using digital encoding, similar to the way a PC operates. By using digital technology, there is no variation in picture and sound quality from the origination point until it is displayed on your television. You always receive a high-quality picture without the wavy lines or static you might sometimes get from a weak analog signal.

Because DTV receives and displays digital images that contain many times more picture elements (pixels - the small dots that make up the color image on your screen) than standard analog television, you can get a sharper on-screen image than with analog. Additionally, DTV supports CD-quality sound. DTV includes SDTV (Standard Definition Television), EDTV (Enhanced Definition Television), and HDTV (High-Definition Television). That means that all HDTV is digital, but not all digital TV is high-definition. A high-definition program must originate in HD format and be broadcast in HD format. Having an HDTV system does not mean that everything you watch will be in high-definition. Getting the signal from digital cable also does not mean it is high-definition.

## What is Standard-Definition Television?

Standard-definition television (SDTV) is basic digital television programming delivered by cable. Typically, the SDTV screen is the same, nearly square shape as an analog television screen. Digital images on an SDTV set are crisp and clear—noticeably better than on a standard analog television set using an antenna to receive over-the-air signals.

## What is High-Definition Television?

High-definition television (HDTV) is a completely new way to send and receive television broadcast signals. HDTV images are made up of pixels that are much smaller and closer together than those used in standard analog television, and there are millions of them. Thus, HDTV can display five to six times the detail of analog television to deliver picture quality that is much more realistic, dimensional, and precise. SDTV programs can be viewed on an HDTV. Another feature of HDTV is digital surround sound using Dolby Digital®, which is the same technology used to produce the sound you hear in movie theaters.

## Are Local TV Stations Broadcasting in HDTV?

Many local TV stations are transmitting digital signals. However, transmitting a digital signal does not mean transmitting an HDTV signal. Some stations are using the new bandwidth to broadcast several standard-definition channels. Most stations, once they begin broadcasting in digital, are offering HD content from their parent network (for example, CBS, ABC, NBC, Fox, WB, UPN, and PBS).

## Why Are Some HDTVs 4:3 Aspect Ratio and Others 16:9?

The aspect ratios differ because television manufacturers build both standard-screen and wide-screen HDTVs to appeal to consumer viewing preferences. The two aspect ratios are as follows:

- On wide-screen (16:9) HDTVs, the programming is displayed on the full screen.
- On standard-screen (4:3) HDTVs, the programming is displayed in letterbox format in the middle of the screen. (There are bars surrounding the picture.)

## Where Are the Connection Diagrams?

The diagrams at the end of this guide show examples of common ways to connect the 8300HD to your HDTV, DVD, and home theater receiver. However, these diagrams do not show every possible combination of devices. Refer to the user's guides that came with your other electronic devices for further information.

## What Cables Do I Need?

Some of the cables and adaptors shown in the diagrams may not be included with the 8300HD. The required cables are shown in the connection diagrams in this guide.

# Picture Formats

## What is the Difference Between a Standard-Screen and a Wide-Screen HDTV

The type of screen your HDTV has (wide screen or standard screen) determines how the 8300HD displays programs on the screen. The picture format for an HDTV is a combination of *aspect ratio* and *screen resolution* and is different for standard-screen and wide-screen HDTVs.

### What is Aspect Ratio?

An aspect ratio is the ratio of the width to the height of the TV screen. The aspect ratios differ because the television industry manufactures both standard-screen and wide-screen HDTVs to appeal to consumer viewing preferences.

### What is the Screen Resolution and Scan Rate?

The screen resolution indicates the amount of detail that the picture displays. Resolution is identified by the number of display lines on the screen. The techniques that an HDTV uses to “paint” the picture on the screen are referred to as progressive and interlaced.



With the **progressive method**, every pixel on the screen is refreshed simultaneously. The **interlace method** involves refreshing pixels in alternation — first the odd lines and then the even lines.

For advance setup, select the scan modes that your TV can support. Refer to your DVR and HDTV user’s guides to choose the proper scan rates (480i, 480p, 720p, 1080i) for your setup.

For example, a resolution of 1080i indicates that the screen shows 1080 lines in an interlaced display, and 480p indicates that the screens shows 480 lines in a progressive display.

#### Notes:

- The screen resolution (1080i, 480p, and so forth) is sometimes referred to as the scan rate. The terms are interchangeable.
- You can stretch and zoom the displayed picture using the built-in capability of the 8300HD by pressing the # key on the remote control. Refer to your DVR user’s guide for more information on this feature.

<p>A <b>standard-screen HDTV</b> has a 4x3 aspect ratio. The screen is 4 units wide for every 3 units tall.</p>  <p>A screen resolution of 480p or 480i fills the screen.</p>	<p>A <b>wide-screen HDTV</b> is one-third wider than a standard-screen HDTV. The screen is 16 units wide for every 9 units tall.</p>  <p>A screen resolution of 720p or 1080i fills the screen.</p>
--	---



# Connecting the 8300HD to an HDTV With an HDMI Connector

## Explorer 8300HD DVR

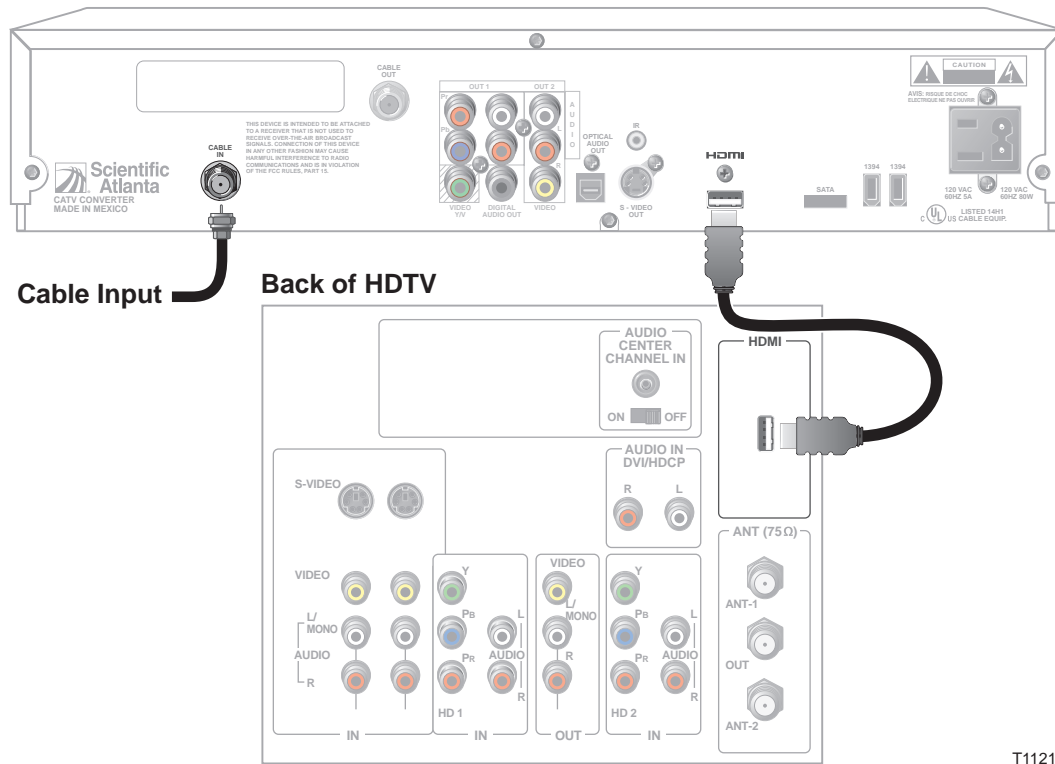

### WARNING:

Electric shock hazard! Unplug all electronic devices before connecting or disconnecting any device cables to the 8300HD.

## Important Note Regarding the HDMI Interface on the 8300HD

The HDMI interface will automatically configure the audio output for a format supported by the television. Because not all TVs support a Dolby Digital input, the HDMI interface may automatically select a 2-channel stereo audio configuration instead of Dolby Digital. When the output is configured for 2-channel audio, this configuration is carried over to the other digital audio outputs of the 8300HD. This configuration prevents your home theater system or Dolby Digital decoder from providing the full Dolby Digital surround sound effect.

On the 8300HD, you may override the automatic selection of audio by the HDMI interface by completing the following steps.

1. Press **SETTINGS** twice on the remote control to open the General Settings menu.
2. Press **MOVE UP** or **MOVE DOWN** to select the option Audio: Digital Out.
3. Press **MOVE RIGHT** to select Dolby Digital. This setting will send Dolby Digital audio to the HDMI, DIGITAL AUDIO OUT, and OPTICAL AUDIO OUT connectors on the 8300HD.

**Note:** If the TV (video/audio monitor) connected to the 8300HD using HDMI is not Dolby Digital capable, it may not produce audio through its speakers when the Audio: Digital Out setting on the 8300HD is set to Dolby Digital. You can either switch the Audio: Digital Out setting back to HDMI when you are not using the home theater or Dolby Digital decoder, or you can connect the baseband audio outputs (OUT 1 Audio Left and Right) to the TV.

# Connecting the 8300HD to an HDTV With a DVI Connector

## Explorer 8300HD DVR

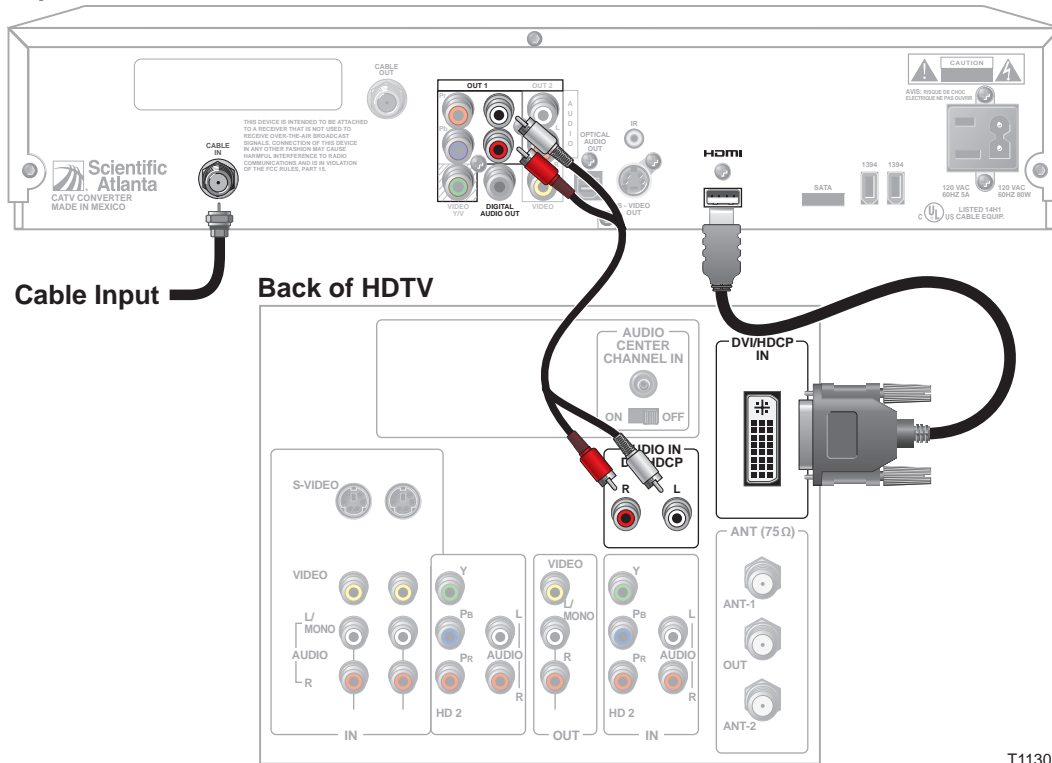

T11308

**Note:** When connecting the HDMI connector to the DVI connector on your HDTV, you need an HDMI-to-DVI adaptor, and you need a separate audio connection.



### WARNING:

**Electric shock hazard! Unplug all electronic devices before connecting or disconnecting any device cables to the 8300HD.**

# Connecting the 8300HD to an HDTV With Component Input (PrPbY/V)

## Explorer 8300HD DVR

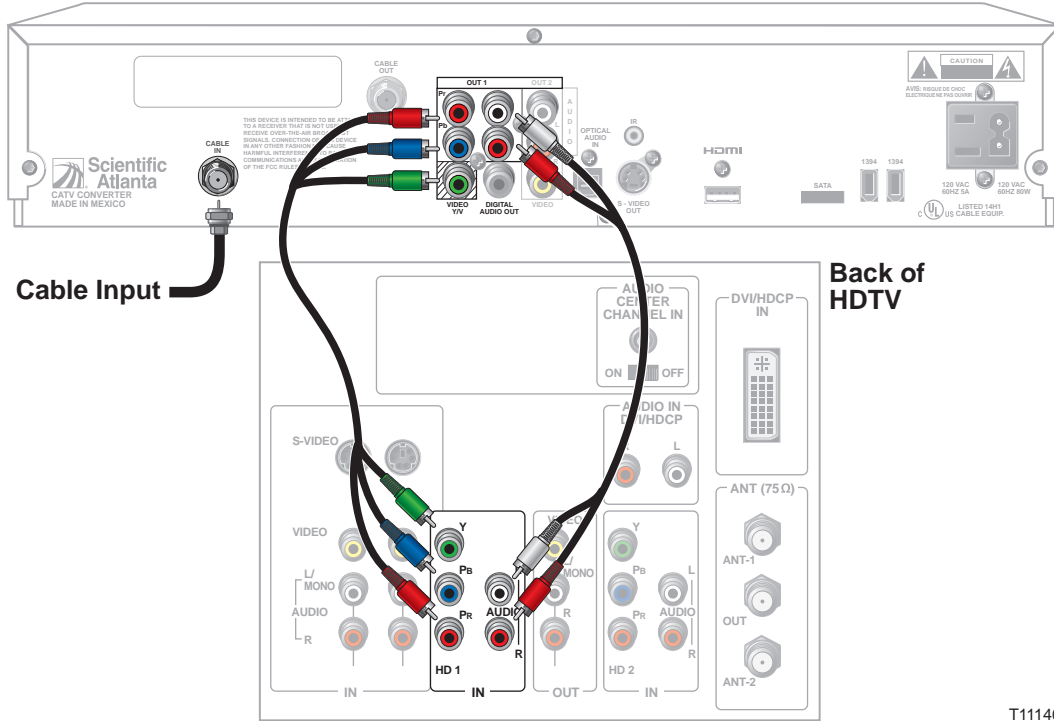

### WARNING:

Electric shock hazard! Unplug all electronic devices before connecting or disconnecting any device cables to the 8300HD.

T11140

# Connecting the 8300HD to a Home Theater System With Component Input (PrPbY/V)

Explorer 8300HD DVR

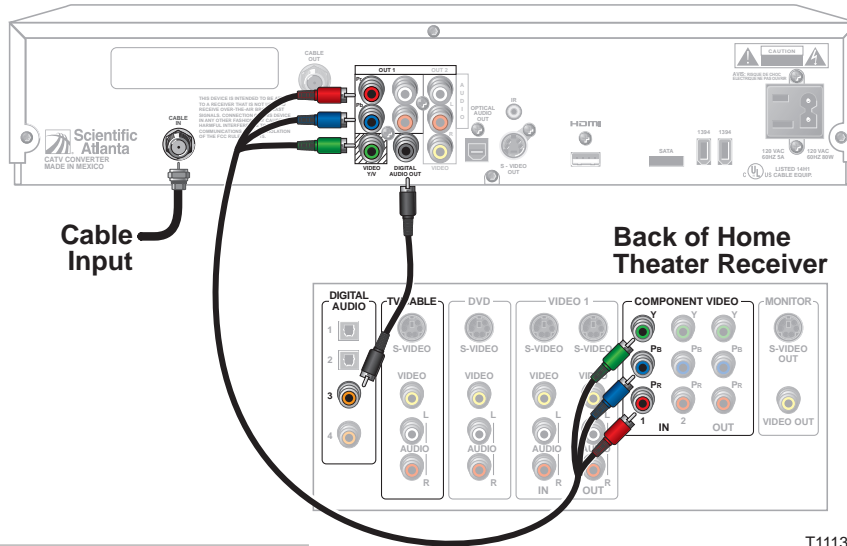

T11139

**WARNING:**  
 Electric shock hazard! Unplug all electronic devices before connecting or disconnecting any device cables to the 8300HD.

Back of Home Theater Receiver

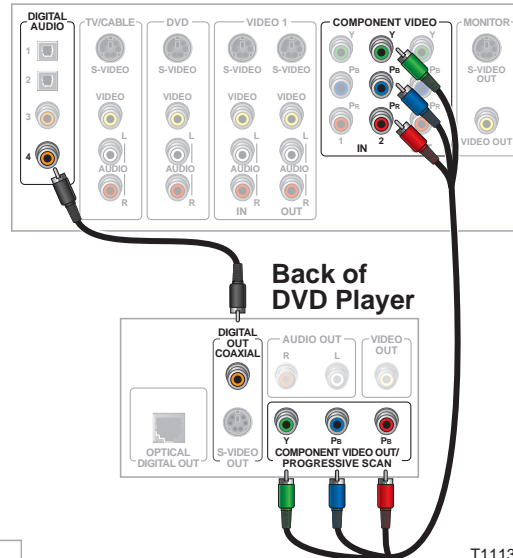

T11135

Back of Home Theater Receiver

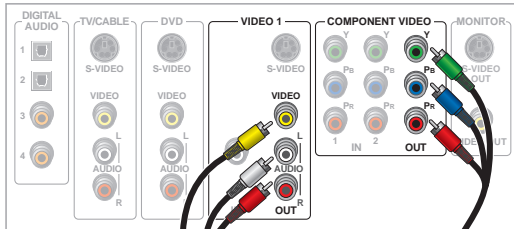

Back of HDTV

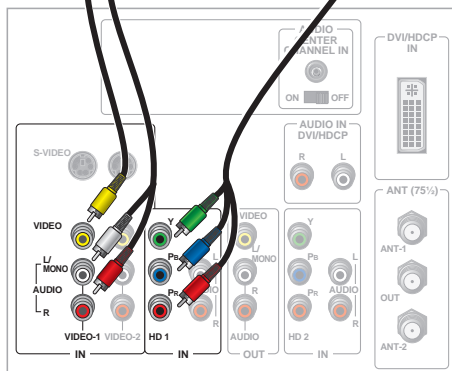

T11136

**Note:** This connection assumes that audio is provided by the home theater speakers.

# Connecting the 8300HD to a Stereo VCR and HDTV (optional)

## Explorer 8300HD DVR

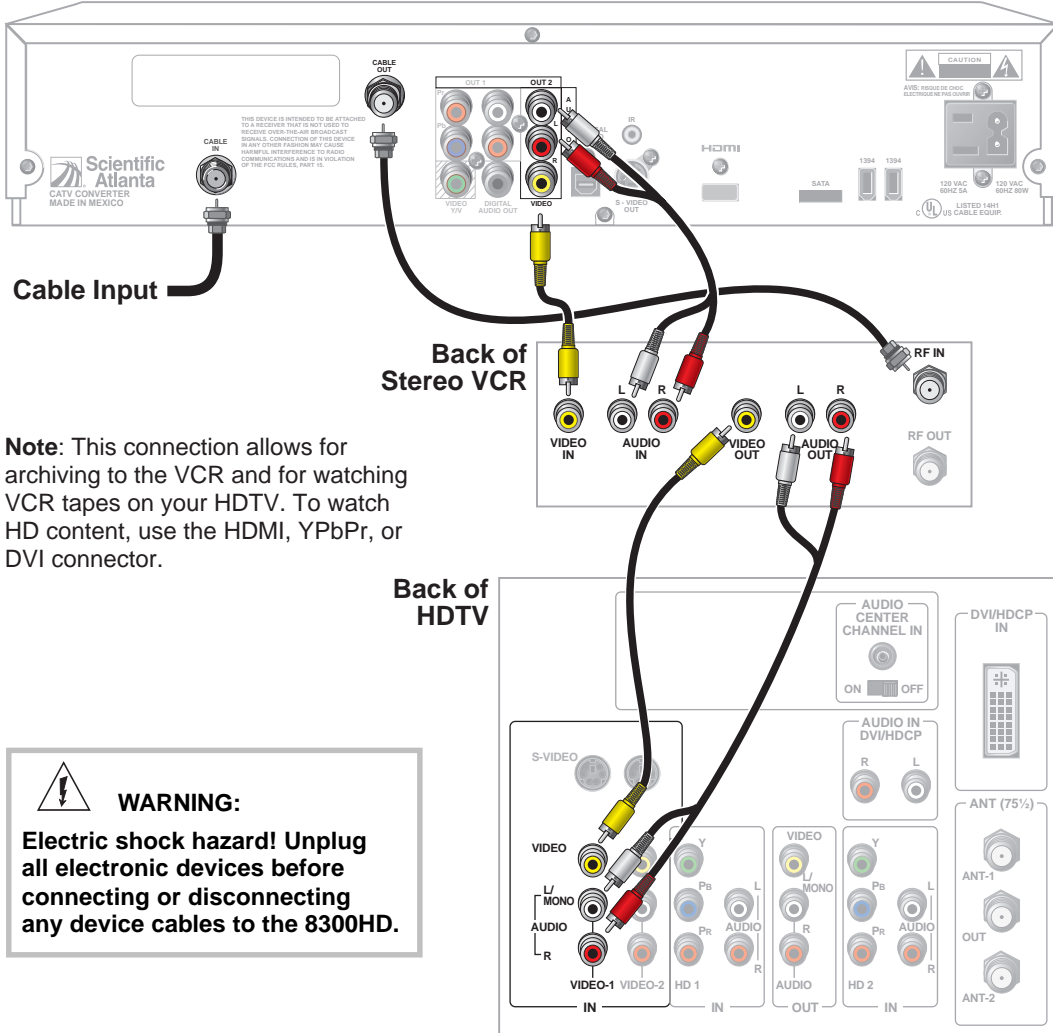

T11332

# Connecting the 8300HD to an External SATA Hard Disk Drive (optional)

Complete the following steps to install a SATA drive.

1. Make sure that both the 8300HD and the external SATA drive are unplugged from power.
2. Connect the data cable for the SATA drive to the 8300HD.
3. Plug in power to the external SATA drive.
4. Plug in the 8300HD power cord, and then turn on the 8300HD.
5. Follow the on-screen instructions. One of the following occurs:
  - If it is a new drive or one used on another device, you will be asked to format it.
  - If the drive is formatted and will work with this 8300HD, you will get a confirmation that the drive is working.

## Explorer 8300HD DVR

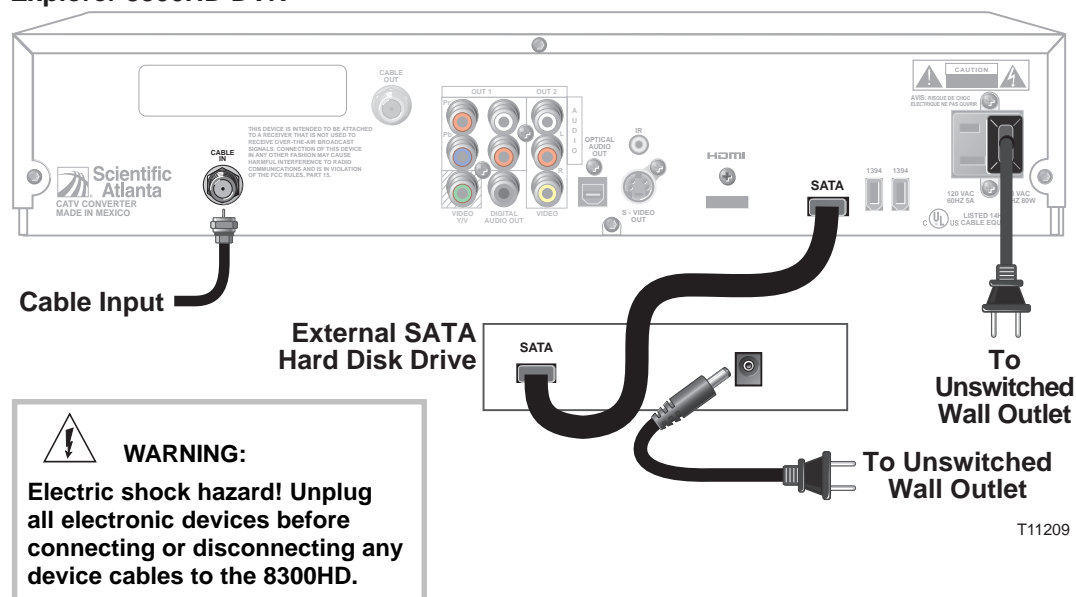

## Guidelines for Using the External SATA Hard Disk Drive

The external SATA hard disk drive requires continuous power. If the SATA drive loses power while the 8300HD is plugged in, the 8300HD may stop current recordings or not provide enough space for future recordings. Follow these guidelines for using the SATA drive:

- Do *not* plug in the power cord for the SATA drive to a switched outlet or to the AC outlet on the 8300HD.
- Do *not* turn off, disconnect, or unplug the SATA drive while the 8300HD is plugged in.

## Recommendations for the SATA Drive

Contact your cable service provider for a list of approved external SATA hard disk drives. At a minimum, your SATA drive should have these capabilities:

- External SATA Connector - *SATA II: Cable and Connector, Revision 1.0* ([www.sata-io.org](http://www.sata-io.org) for more information)
- Drive Speed: 7200 RPM (5400 RPM without Multi-room); 133 MB/sec
- Capacity: Only one SATA drive can be connected to the 8300HD. The 8300HD will not support a separate port multiplier.
- SATA Drive Power: The SATA drive should power on when plugged in and should not be controlled by a switch.

## Connecting the 8300HD to an External SATA Hard Disk Drive (optional), continued

### Disconnecting the External SATA Hard Disk Drive

Complete the following steps to disconnect the SATA drive safely.

1. Make sure that the 8300HD is powered off.
2. Disconnect the power cord from the 8300HD and wait for at least 10 seconds.
3. Disconnect the power cord and data cable from the external SATA drive.

If you improperly disconnect your SATA drive, you will receive an error message, and you will be required to restart the 8300HD upon reconnecting.

### How the SATA Drive Works with Your 8300HD

Recordings are balanced between the internal hard drive on the 8300HD and the external SATA drive as follows:

- A recording is not split between an internal and external hard drive.
- The 8300HD automatically stores complete programs using the following space available logic:
  - If the external SATA drive has more space available, the SATA drive stores the next recording.
  - If the internal hard drive on the 8300HD has more space available, the internal hard drive stores the next recording.

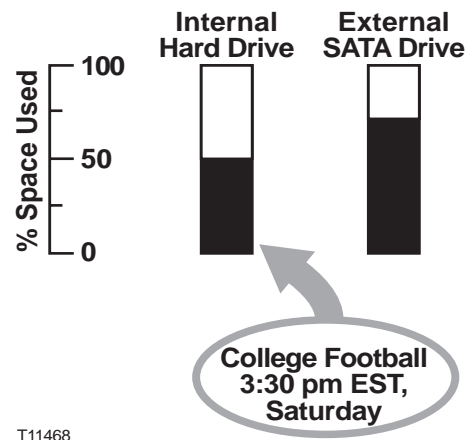
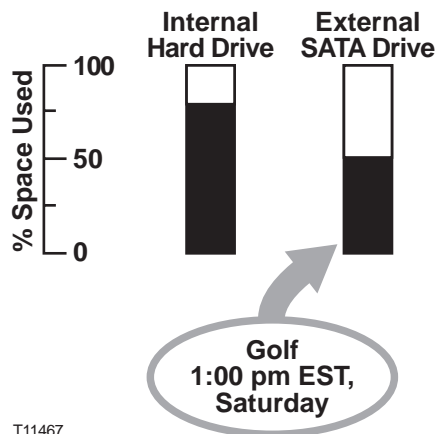

# Connecting the 8300HD in HD Mode to an SDTV With Component Input (PrPbY/V)

## Explorer 8300HD DVR Set to HD Mode

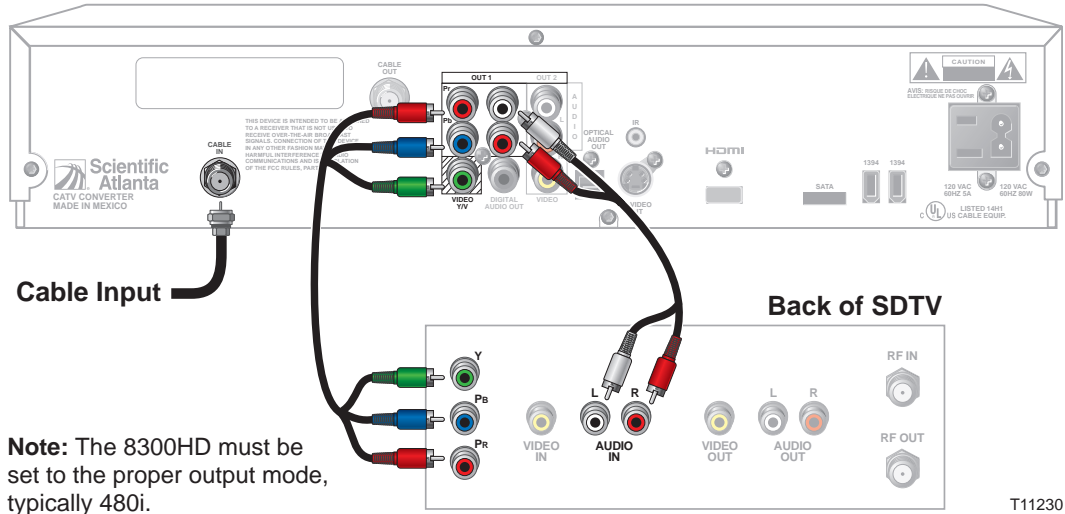

T11230



### WARNING:

Electric shock hazard! Unplug all electronic devices before connecting or disconnecting any device cables to the 8300HD.

# Connecting the 8300HD in SD Mode to an SDTV

## Explorer 8300HD DVR Set to SD Mode

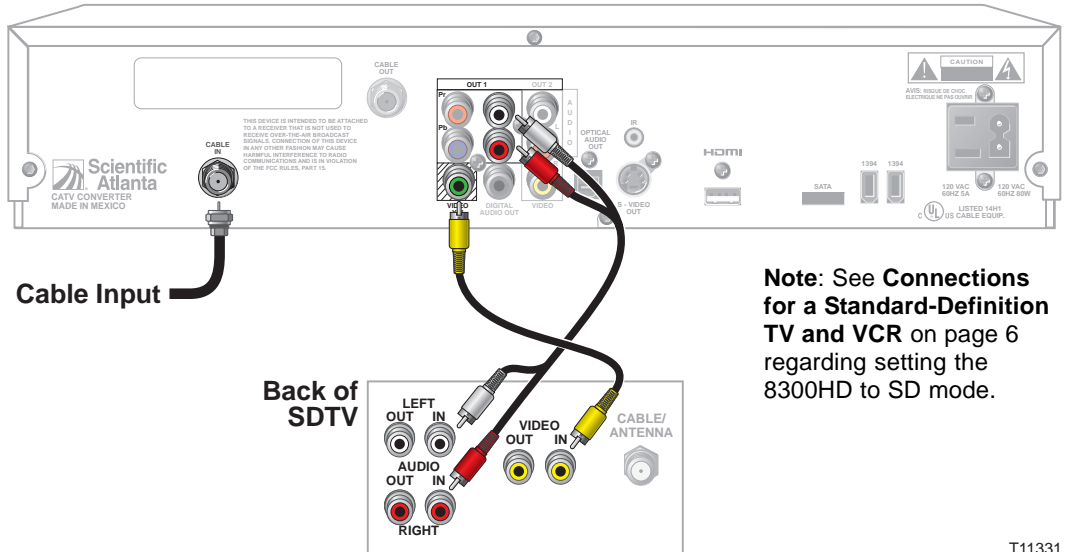

T11331



### WARNING:

Electric shock hazard! Unplug all electronic devices before connecting or disconnecting any device cables to the 8300HD.



# Compliance Information

## United States FCC Compliance

This equipment has been tested and found to comply with the applicable limits of Part 15 of the FCC Rules. These limits are designed to provide reasonable protection against harmful interference in a residential installation. This equipment generates, uses, and can radiate radio frequency energy and, if not installed and used in accordance with the instructions, may cause harmful interference to radio or TV reception, which can be determined by turning the equipment off and on. The user is encouraged to try to correct the interference by one or more of the following measures:

- Increase the separation between the equipment and receiver
- Connect the equipment into an outlet on a circuit different from that to which the receiver is connected
- Consult your cable company or an experienced radio/TV technician for help

Any changes or modifications not expressly approved by Scientific-Atlanta could void the user's authority to operate the equipment.

**Important:** The information shown in the FCC Declaration of Conformity paragraph below is a requirement of the FCC and is intended to supply you with information regarding the FCC approval of this device. *The phone numbers listed are for FCC-related questions only and not intended for questions regarding the connection or operation for this device. Please contact your cable service provider for any questions you may have regarding the operation or installation of this device.*

## FCC Declaration of Conformity

This device complies with *Part 15 of the FCC Rules*. Operation is subject to the following two conditions:

1) this device may not cause harmful interference, and 2) this device must accept any interference received, including interference that may cause undesired operation.

EXPLORER® 8300HD  
Digital Video Recorder:  
Model 8300HD  
Manufactured by: Scientific-Atlanta, Inc.;  
5030 Sugarloaf Parkway;  
Lawrenceville, Georgia 30044; USA  
Telephone **770-236-1077**

## Canada EMI Regulation

This Class B digital apparatus complies with Canadian ICES-003.

Cet appareil numérique de la class B est conforme à la norme NMB-003 du Canada.

## Software and Firmware Use

Scientific-Atlanta, Inc. owns copyrights to the software included in your set-top and furnishes the software to your cable service provider under a license agreement. You may only use or copy this software in accordance with the terms of your cable service provider.

Scientific-Atlanta, Inc. owns copyrights to the firmware in this equipment. You may only use the firmware in the equipment in which it is provided. Any reproduction or distribution of this firmware, or any portion of it, without the express written consent of Scientific-Atlanta, Inc. is prohibited.

## Trademarks

8300HD, Explorer, Scientific-Atlanta, and the Scientific-Atlanta logo are registered trademarks of Scientific-Atlanta, Inc. Dolby is a registered trademark of Dolby Laboratories. HDMI, the HDMI logo, and High-Definition Multimedia Interface are trademarks or registered trademarks of HDMI Licensing LLC. All other trademarks shown are trademarks of their respective owners.

## Disclaimer

Scientific-Atlanta, Inc. assumes no responsibility for errors or omissions that may appear in this guide. Scientific-Atlanta reserves the right to change this guide at any time without notice.

# Index

1394 Firewire 3

## A

### AC

Outlet 3, 16

Power input 3

Aspect ratio 10

## B

Back panel 3

Burn-in of screen 7

## C

Cables 9

Cable Out 6

Compliance, FCC 19

Component video connection. *See* PrPbY/V

Composite 6

### Connectors

*See also* Front panel; Back panel

required for HDTV 5

required for SDTV 6

VCR 5, 6

Connecting the 8300HD to other devices

*See also* Web access to product information

HDTV with Component input (PrPbY/V) 13

HDTV with DVI connector 12

HDTV with HDMI connector 11

HDTV with VCR 15

Home Theater System with Component input (PrPbY/V) 14

SATA drive, external 16, 17

SDTV 18

Controls (*See* Front panel)

## D

Diagrams. *See* Connecting the 8300HD to other devices

Digital Video Recorder. *See* DVR, What is it

Digital TV, What is it 9

Display, LED 2

DVI connector 3, 5, 12

DVR, What is it 1

## E

External hard disk drive. *See* SATA

## F

FAQs 9

FCC compliance 19

Formats, picture 10

Frequently Asked Questions. *See* FAQs

Front panel 2

## H

Hard disk drive, external. *See* SATA

### HD

mode 3, 4, 5, 6, 18

format 1, 9

TV, What is it 9

HDMI 3, 5, 11

High-definition (*See* HD)

Home theater system connection 14

## I

Interlaced scan rate 10

IR Sensor 2

## K

Keys. *See* Front panel; Back panel

## L

LED Display 2

## Index, continued

### P

- Performance tips 8
- Picture formats 10
- Picture-in-picture. *See* PIP
- PIP 7
- Ports. *See* Connectors
- Product information. *See* Web access to product information
- Programs, view 7
- Progressive scan rate 10
- PrPbY/V
  - connector 3, 5, 6
  - HDTV connection 13
  - home theater connection 14
  - SDTV connection 18

### R

- Record programs 1, 7
- Remote control 7
- RGB connector 5

### S

- S-Video 6
- Safety iv, v, 1
- SATA 3, 16, 17
- Scan rates 10
- Screen
  - burn-in 7
  - resolution 10
  - size 10

### SD

- Mode 3, 4, 6, 18
- TV, What is it 9
- Serial number, locating 1
- Set-top. *See* DVR, What is it
- Software updates 8
- Sound, performance 8
- Smart card 2
- Standard-definition, What is it 9
- Standard screen TV 10
- Stretching and zooming programs 7

### T

#### TV

- digital, what is it 9
- formats 10
- HDTV, what is it 9
- programming 7
- recording 1, 7
- resolution 10
- standard screen 10
- standard-definition, what is it 9
- wide screen 10

### U

- Updating, software 8
- USB port 2

### V

- VCR connection 5, 6, 15
- View programs 7

### W

- Watch TV 7
- Web access to product information 1
- Widescreen TV 10

### Y

- YPbPr. *See* PrPbY/V



© 2005 by Scientific-Atlanta, Inc. All rights reserved.

Product and service availability subject to change without notice.

Scientific-Atlanta, Inc., 5030 Sugarloaf Parkway, P.O. Box 465447, Lawrenceville, GA 30042

[www.scientificatlanta.com](http://www.scientificatlanta.com)

February 2005 Printed in USA

4003986 Rev D

## Free Manuals Download Website

<http://myh66.com>

<http://usermanuals.us>

<http://www.somanuals.com>

<http://www.4manuals.cc>

<http://www.manual-lib.com>

<http://www.404manual.com>

<http://www.luxmanual.com>

<http://aubethermostatmanual.com>

Golf course search by state

<http://golfingnear.com>

Email search by domain

<http://emailbydomain.com>

Auto manuals search

<http://auto.somanuals.com>

TV manuals search

<http://tv.somanuals.com>