

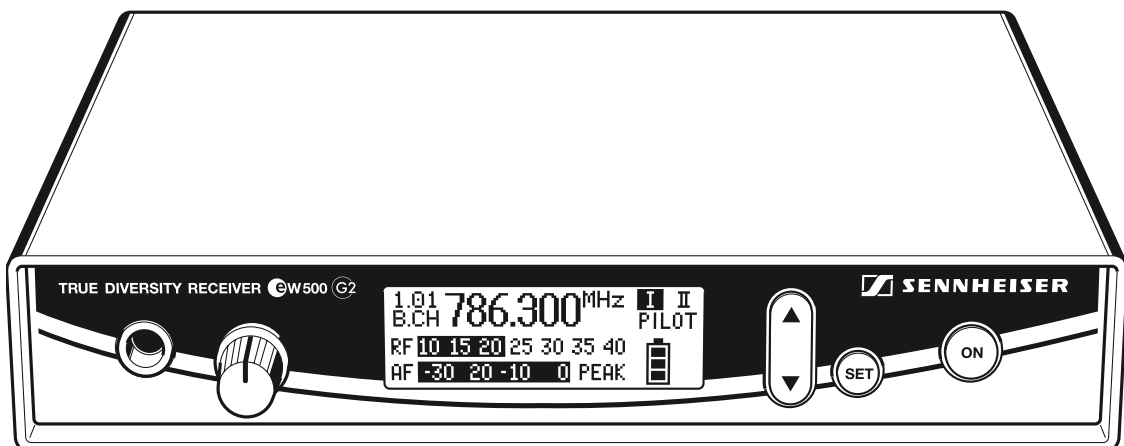

# EM 500

Instructions for use





## **Thank you for choosing Sennheiser!**

We have designed this product to give you reliable operation over many years. Over half a century of accumulated expertise in the design and manufacture of high-quality electro-acoustic equipment have made Sennheiser a world-leading company in this field.

Please take a few moments to read these instructions carefully, as we want you to enjoy your new Sennheiser product quickly and to the fullest.

# Contents

The EM 500 G2 rack-mount receiver .....	4
The channel bank system .....	4
Safety instructions .....	5
Areas of application .....	6
Delivery includes .....	6
Overview of operating controls .....	7
Indications and displays .....	8
Indications and displays of the receiver .....	8
Remote displays of an ew 500 G2 transmitter .....	8
Preparing the receiver for use .....	10
Mounting the receiver feet .....	10
Connecting the antennas .....	10
Connecting the mains unit .....	10
Connecting the amplifier/mixing console .....	11
Service interface .....	11
19" rack adapter and antenna mount .....	11
Using the receiver .....	13
Switching the receiver on/off .....	13
Connecting the headphones/adjusting the volume .....	13
Activating/deactivating the lock mode .....	13
The operating menu .....	14
The buttons .....	14
Overview of menus .....	14
Working with the operating menu .....	15
Operating menu of the receiver .....	16
Adjustment tips for the operating menu .....	19
Switching between channel banks .....	19
Switching between the channels in a channel bank .....	19
Selecting the frequencies to be stored in the channel bank "U" .....	19
Scanning the channel banks for free channels .....	19
Multi-channel operation .....	20
Adjusting the audio output level .....	21
Adjusting the squelch threshold .....	21
Doing the soundcheck .....	21
Selecting the standard display .....	22
Entering a name .....	23
Loading the factory-preset default settings .....	23
Activating/deactivating the pilot tone evaluation .....	23
Activating/deactivating the lock mode .....	24
Using the equalizer .....	24
Adjusting the contrast of the graphic display .....	24
Exiting the operating menu .....	24
Troubleshooting .....	25
Error checklist .....	25
Recommendations and tips .....	26
Care and maintenance .....	26
Additional information .....	27
HDX noise reduction .....	27
Wireless transmission systems .....	27
Squelch .....	28
Diversity reception .....	28
Specifications .....	29
Connector assignment .....	30
Accessories .....	30
Manufacturer declarations .....	31
Warranty regulations .....	31
CE Declaration of Conformity .....	31
Batteries or rechargeable batteries .....	31
WEEE Declaration .....	31

# The EM 500 G2 rack-mount receiver

The EM 500 G2 rack-mount receiver is part of the evolution wireless series ew 500 G2. With this series, Sennheiser offers high-quality state-of-the-art RF transmission systems with a high level of operational reliability and ease of use. Transmitters and receivers permit wireless transmission with studio-quality sound. The excellent transmission reliability of the ew 500 G2 series is based on the use of

- further optimized PLL synthesizer and microprocessor technology,
- the [HDX](#) noise reduction system,
- the pilot tone squelch control,
- the true diversity technology (rack-mount receiver only),
- and the scan function for scanning the channel banks for free channels.

## The channel bank system

The EM 500 G2 receiver is available in five UHF frequency ranges with 1440 receiving frequencies per frequency range. Please note: Frequency usage is different for each country. Your Sennheiser agent will have all the necessary details on the available legal frequencies for your area.

Range A: 518 to 554 MHz  
Range B: 626 to 662 MHz  
Range C: 740 to 776 MHz  
Range D: 786 to 822 MHz  
Range E: 830 to 866 MHz

The receiver has nine channel banks with up to 20 switchable channels each.

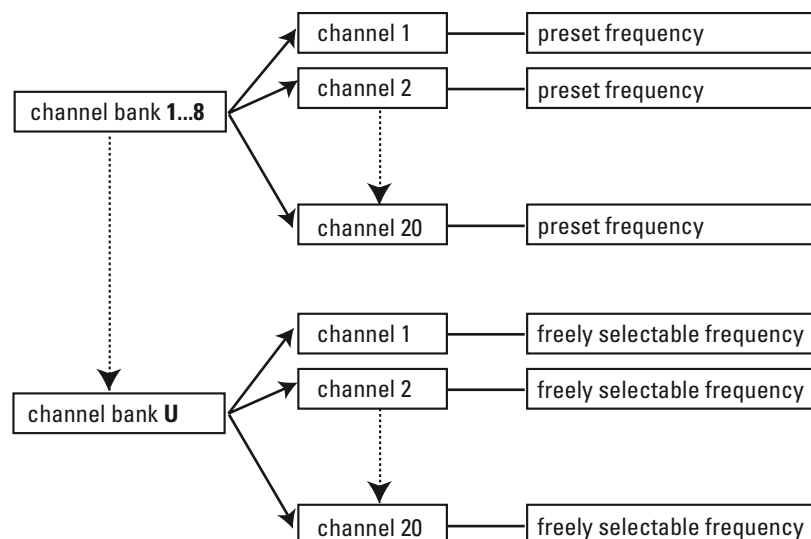

Each of the channels in the channel banks "1" to "8" has been factory-preset to a receiving frequency (see enclosed frequency table). These receiving frequencies cannot be changed but have been preset so that e.g. country-specific regulations on frequency usage are taken into account.

The channel bank "U" (user bank) allows you to store your selection out of 1440 receiving frequencies that are freely selectable within the preset frequency range.

# Safety instructions

Never open an electronic unit! If units are opened by customers in breach of this instruction, the warranty becomes null and void.

Keep the unit away from central heating radiators and electric heaters. Never expose it to direct sunlight.

Use the unit in dry rooms only.

Use a damp cloth for cleaning the unit. Do not use any cleansing agents or solvents.

## Attention! High Volume!



This is a professional transmission system. Commercial use is subject to the rules and regulations of the trade association responsible. Sennheiser, as the manufacturer, is therefore obliged to expressly point out possible health risks arising from use.

This system is capable of producing sound pressure exceeding 85 dB(A). 85 dB(A) is the sound pressure corresponding to the maximum permissible volume which is by law (in some countries) allowed to affect your hearing for the duration of a working day. It is used as a basis according to the specifications of industrial medicine. Higher volumes or longer durations can damage your hearing. At higher volumes, the duration must be shortened in order to prevent damage. The following are sure signs that you have been subjected to excessive noise for too long a time:





- You can hear ringing or whistling sounds in your ears.
- You have the impression (even for a short time only) that you can no longer hear high notes.

## Areas of application

The EM 500 G2 receiver can be combined with transmitters of the ew 500 G2 series (SK 500 G2 bodypack transmitter, SKM 500 G2 radiomicrophone or SKP 500 G2 plug-on transmitter). The transmitters are available in the same five UHF frequency ranges and are equipped with the same channel bank system with factory-preset frequencies. An advantage of the factory-preset frequencies is that

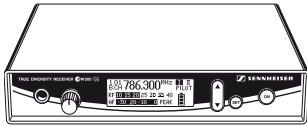
- a transmission system is ready for immediate use after switch-on,
- several transmission systems can be operated simultaneously on the preset frequencies without causing intermodulation interference.

Together with a matching transmitter and a microphone, the receiver is suitable for the following areas of applications:

Receiver	Transmitter (to be ordered separately)	Area of application
EM 500 G2 	SK 500 G2 	<ul style="list-style-type: none"> <li>• Theater</li> <li>• Presentation</li> <li>• Sports (aerobic)</li> <li>• Vocals</li> <li>• Using instruments wirelessly</li> </ul>
	SKM 500 G2 	<ul style="list-style-type: none"> <li>• Speech</li> <li>• Vocals</li> <li>• Presentation</li> </ul>
	SKP 500 G2 	<ul style="list-style-type: none"> <li>• Speech</li> <li>• Vocals</li> <li>• Presentation</li> </ul>

## Delivery includes

The packaging contains the following items:

- 1 EM 500 G2 rack-mount receiver
- 1 NT 2-1 mains unit
- 2 telescopic antennas
- 1 GA 2 rack adapter
- Instructions for use

# Overview of operating controls

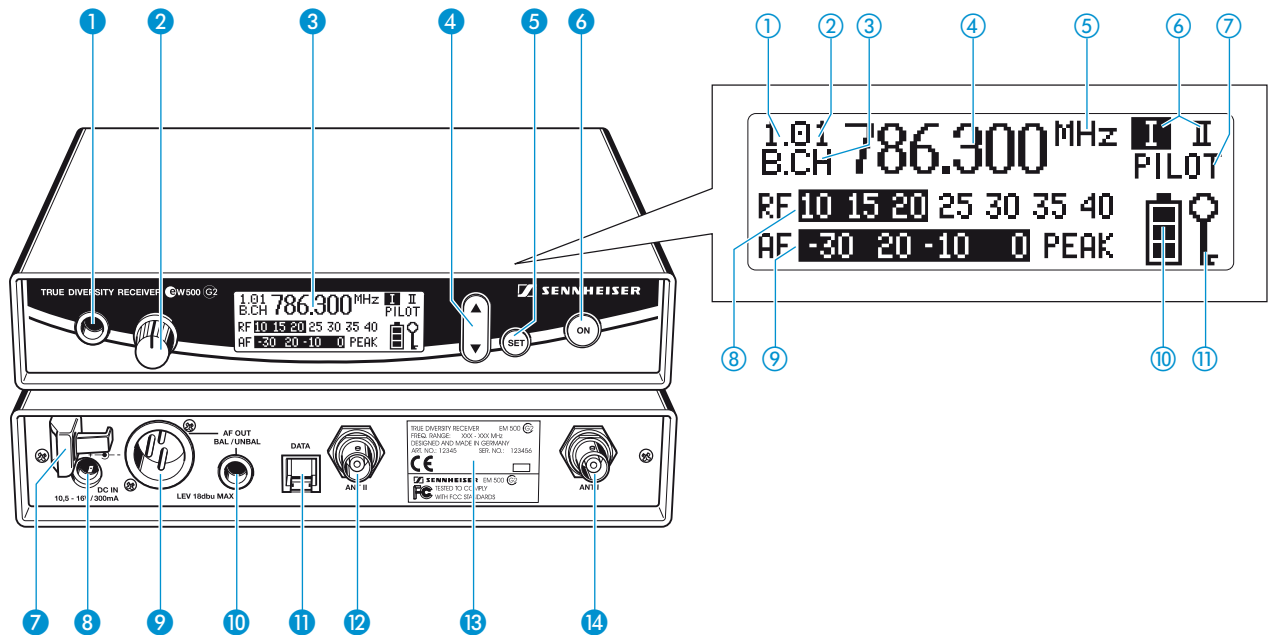

## Operating controls

- ① Headphone output (PHONES), 1/4" (6.3 mm) jack socket
- ② Headphone volume control (VOL)
- ③ Graphic display, backlit
- ④ ▲/▼ rocker button, backlit
- ⑤ SET button, backlit
- ⑥ ON button, backlit (serves as the ESC (cancel) key in the operating menu)
- ⑦ Cable grip for power supply DC cable
- ⑧ DC socket for connection of mains unit (DC IN)
- ⑨ Audio output (AF OUT BAL), XLR-3M socket, balanced
- ⑩ Audio output (AF OUT UNBAL), 1/4" (6.3 mm) jack socket, unbalanced
- ⑪ Service interface (DATA)
- ⑫ Antenna input II (ANT II), BNC socket
- ⑬ Type plate
- ⑭ Antenna input I (ANT I), BNC socket

## Graphic display panel

- ① Display for the current channel bank "1...8, U"
- ② Display for the current channel number "1...20"
- ③ "B.CH" – abbreviation for channel bank and channel number
- ④ Alphanumeric display
- ⑤ "MHz" – appears when the frequency is displayed
- ⑥ Diversity display (antenna I or antenna II active)
- ⑦ "PILOT" display (pilot tone evaluation is activated)
- ⑧ Level display for received RF signal "RF"
- ⑨ Level display for received audio signal "AF", with "PEAK" warning
- ⑩ 4-step transmitter battery status display
- ⑪ Lock mode icon (lock mode is activated)

### Note:

For further illustrations and examples of the different standard displays, please refer to the section "Selecting the standard display" on page 22.

# Indications and displays

When used together with an ew 500 G2 transmitter, the receiver provides information on its operating states and those of the received transmitter (remote displays).

## Indications and displays of the receiver

### “PILOT” display

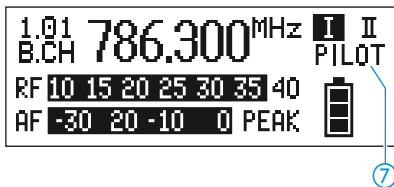

The “PILOT” display ⑦ appears on the display panel when the pilot tone evaluation is activated (see “Activating/deactivating the pilot tone evaluation” on page 23).

### Diversity display

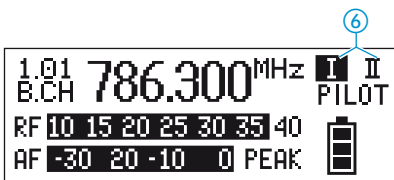

The EM 500 G2 receiver operates on the true diversity principle (see “Diversity reception” on page 28).

The diversity display ⑥ indicates whether diversity section I (i.e. antenna 1) or diversity section II (i.e. antenna 2) is active.

### Button backlighting

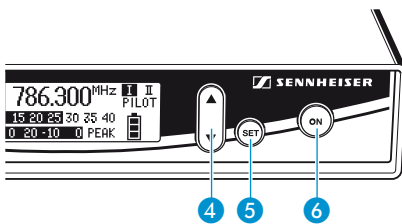

During standby operation, the ON button ⑥ is backlit in red. When the receiver is switched on, the SET button ⑤ and the ▲/▼ button ④ are additionally backlit in green.

## Remote displays of an ew 500 G2 transmitter

### Transmitter battery status indication

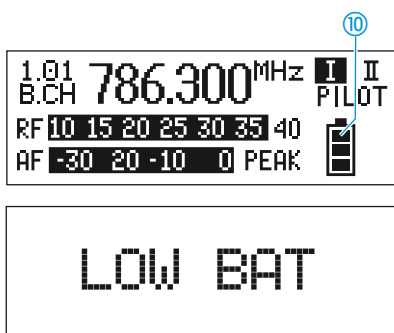

The 4-step transmitter battery status display ⑩ on the receiver display panel provides information on the transmitter's remaining battery/accupack capacity:

3 segments:	capacity approx. 100 %
2 segments:	capacity approx. 70 %
1 segment:	capacity approx. 30 %
Battery icon flashing	LOW BAT

In addition, the text “LOW BAT” (backlit in red) flashes in alternation with the standard display.



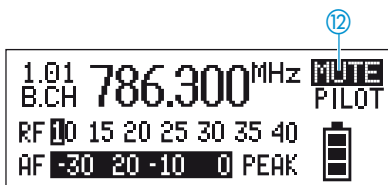

### "MUTE" display

The "MUTE" display ⑫ appears on the display panel and the backlighting of the standard display switches from green to red. In addition, the text "MUTE" flashes in alternation with the standard display when

- the RF signal of the received transmitter is too weak,
- the received transmitter has been muted (with the pilot tone transmission or evaluation activated).

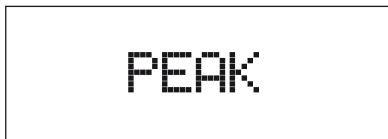
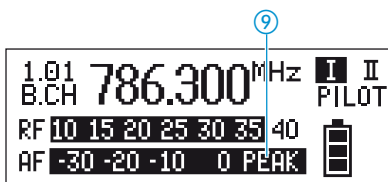

### Modulation display

The level display for audio signal "AF" shows the modulation of the received transmitter.

When the transmitter's audio input level is excessively high, the receiver's level display for audio signal "AF" ⑨ shows full deflection.

When the transmitter is overmodulated frequently or for an extended period of time, the text "PEAK" (backlit in red) flashes in alternation with the standard display.

# Preparing the receiver for use

## Mounting the receiver feet

To ensure that the receiver cannot slip on the surface on which it is placed, four self-adhesive soft rubber feet are supplied.

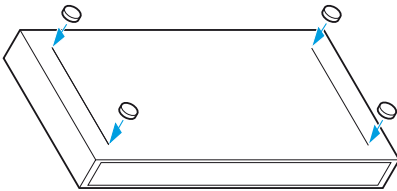

- ▶ Ensure that the base of the receiver is clean and free from grease before mounting the rubber feet.
- ▶ Fix the rubber feet to the base of the receiver by peeling of the safety paper and fitting them as shown in the diagram on the left.

### Attention!

Some furniture surfaces have been treated with varnish, polish or synthetics which might cause stains when they come into contact with other synthetics. Despite a thorough testing of the synthetics used by us, we cannot rule out the possibility of staining.

## Connecting the antennas

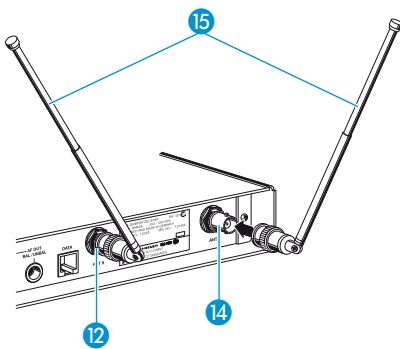

The supplied telescopic antennas can be mounted quickly and easily and are suitable for all applications where – good reception conditions provided – a wireless transmission system is to be used without a large amount of installation work.

- ▶ Connect the telescopic antennas 15 to the BNC sockets 12 and 14 at the rear of the receiver.
- ▶ Pull the telescopic antennas out and align them upwards in a V-shape.

Use remote antennas (available as accessories) when the receiver position is not the best antenna position for optimum reception.

## Connecting the mains unit

The receiver is powered via a mains unit.

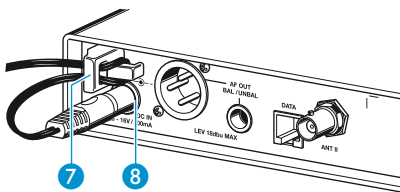

- ▶ Pass the cable through the cable grip 7.
- ▶ Insert the DC connector on the mains cable into the DC socket 8.

## Connecting the amplifier/mixing console

The receiver's audio outputs are available as an XLR-3M socket 9 and a 1/4" (6.3 mm) jack socket 10, allowing you to simultaneously connect two units (e.g. amplifier, mixing console). The adjusted audio output level is common for both sockets.

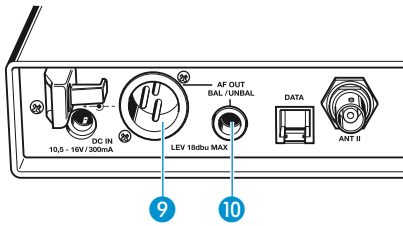

- ▶ Connect the amplifier/mixing console to the XLR-3M socket 9 or the 1/4" (6.3 mm) jack socket 10.

For detailed information on balanced and unbalanced connection, please refer to the section "Connector assignment" on page 30.

- ▶ Via the operating menu, adapt the level of the audio output (AF OUT) to the input of the amplifier or mixing console (see "Adjusting the audio output level" on page 21).

## Service interface

The service interface 11 is only required for servicing purposes.

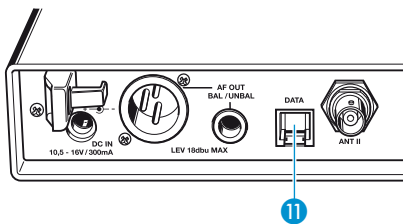

## 19" rack adapter and antenna mount

For mounting one or two receivers into a 19" rack, you require the GA 2 rack adapter (available as an accessory). The GA 2 rack adapter consists of:

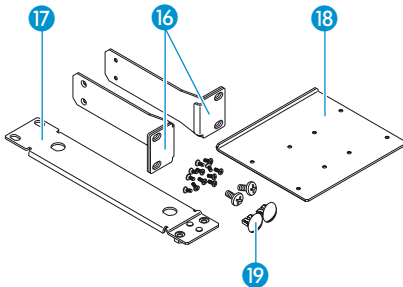

- 2 rack mount "ears" 16
- 1 connecting bar 17
- 1 connecting plate 18
- 2 covering plugs 19 for antenna holes
- 12 recessed head screws M 3x6
- 2 recessed head screws M 6x10

When mounting only one receiver into a rack, you can use the AM 2 antenna mount (available as an accessory) to mount the receiver's antenna connections to the front of the GA 2 rack adapter. The AM 2 antenna mount consists of:

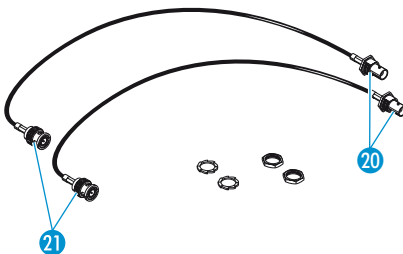

- 2 BNC extension cables (screw-in BNC socket 20 to BNC connector 21)
- 2 plain washers
- 2 nuts

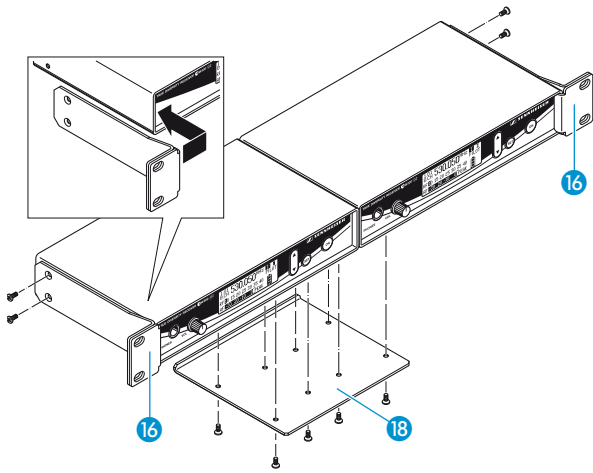

To mount two receivers into a rack:

- ▶ Place the two receivers side by side onto a flat surface, their bottom sides facing upwards.
- ▶ Align the connecting plate 18 over the holes in the bottom sides of the receivers.
- ▶ Secure the connecting plate 18 to the receivers using eight of the supplied recessed head screws (M 3x6).
- ▶ Hook the two rack mount "ears" 16 to the front panels of the receivers.
- ▶ Secure the rack mount "ears" to the receivers using two of the supplied recessed head screws (M 3x6) respectively.
- ▶ Slide the receivers into the 19" rack.
- ▶ Secure the rack mount "ears" to the rack.

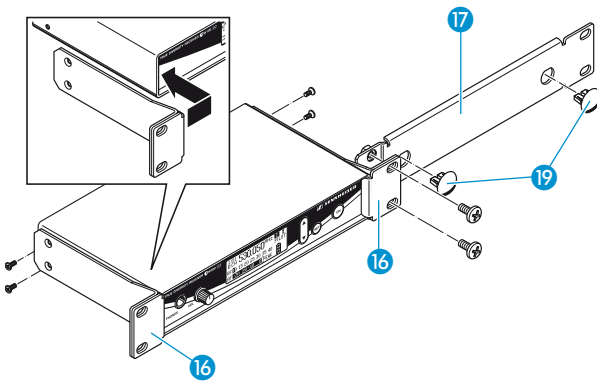

When mounting only one receiver into a rack, use the connecting bar 17 instead of the second receiver.

- ▶ Hook the two rack mount "ears" 16 to the front panel of the receiver.
- ▶ Secure the rack mount "ears" to the receiver using two of the supplied recessed head screws (M 3x6) respectively.
- ▶ Secure the connecting bar 17 to one of the rack mount "ears" 16 using two of the supplied recessed head screws (M 6x10).
- ▶ If you are not front mounting the antennas, insert the two covering plugs 19 into the antenna holes of the connecting bar.
- ▶ Slide the receiver into the 19" rack.
- ▶ Secure the rack mount "ears" to the rack.

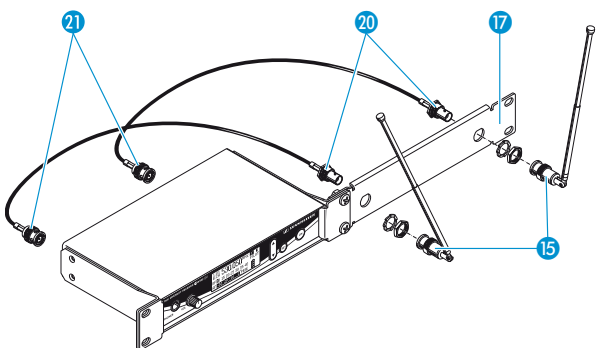

To mount the receiver's telescopic antennas to the front of the GA 2 rack adapter using the AM 2 antenna mount:

- ▶ Screw the two BNC sockets 20 of the BNC extension cables to the connecting bar 17 using the supplied plain washers and nuts.
- ▶ Connect the two BNC connectors 21 to the BNC sockets 12 and 14 at the rear of the receiver.
- ▶ Slide the receiver into a 19" rack.
- ▶ Secure the rack mount "ears" to the rack.
- ▶ Connect the two telescopic antennas 15 to the two BNC sockets 20.
- ▶ Pull the telescopic antennas out and align them upwards in a V-shape.

# Using the receiver

## Switching the receiver on/off

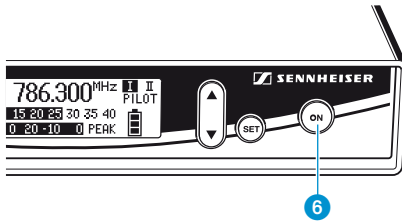

The receiver can only be switched off when the standard display is shown on the display panel. When in the operating menu, briefly pressing the **ON** button will cancel your entry (ESC function) and return you to the standard display with the last stored settings.

- ▶ Press the **ON** button **6** to switch the receiver on.
- ▶ To switch the receiver off, press the **ON** button until "OFF" appears on the display.

## Connecting the headphones/adjusting the volume

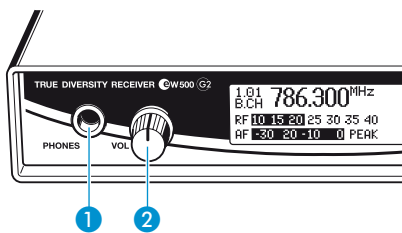

- ▶ To monitor the audio signal, connect headphones with a ¼" (6.3 mm) jack plug to the headphone output (PHONES) **1**.

### Attention! High volume!

Even short exposure to high volume levels will damage your hearing! Set the volume for the connected headphones to the minimum before putting the headphones on.

- ▶ First, set the volume control **2** to the lowest volume by turning it to the left as far as possible. Then gradually turn up the volume.

### Volume up? – NO!

When people use headphones, they tend to choose a higher volume than with loudspeakers. Listening at high volume levels for long periods can lead to permanent hearing defects. Please protect your hearing, Sennheiser headphones have an excellent sound quality even at low volumes.

## Activating/deactivating the lock mode

The receiver has a lock mode that can be activated or deactivated via the operating menu (see "Activating/deactivating the lock mode" on page 24). The lock mode prevents that the receiver is accidentally programmed or switched off during operation.

# The operating menu

A special feature of the Sennheiser ew 500 G2 series is the similar, intuitive operation of transmitters and receivers. As a result, adjustments to the settings can be made quickly and “without looking” – even in stressful situations, for example on stage or during a live show or presentation.

## The buttons

Buttons	Mode	To...
ON	Standard display	switch the receiver on and off
	Operating menu	cancel the entry and return to the standard display
	Setting mode	cancel the entry and return to the standard display
SET	Standard display	get into the operating menu
	Operating menu	get into the setting mode of the selected menu
	Setting mode	store the settings and return to the top menu level
▲/▼	Standard display	without function
	Operating menu	change to the previous menu (▲) or change to the next menu (▼)
	Setting mode	adjust the setting of the selected menu: option (▲/▼)

## Overview of menus

Display	Function of the menu
Bank	Switching between channel banks
Channel	Switching between the channels in a channel bank
Tune	Setting a receiving frequency for the channel bank “U” (user bank)
Scan	Scanning the channel banks for free channels
AF Out	Adjusting the audio output level
Squelch	Adjusting the squelch threshold
Soundcheck	Doing the soundcheck
Display	Selecting the standard display
Name	Entering a name
Reset	Loading the factory-preset default settings
Pilot	Activating/deactivating the pilot tone evaluation
Lock	Activating/deactivating the lock mode
Equalizer	Changing the frequency response of the audio signal
LCD Contr	Adjusting the contrast of the graphic display
Exit	Exiting the operating menu and returning to the standard display

## Working with the operating menu

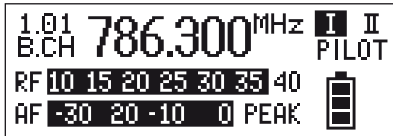

By way of example of the "Tune" menu, this section describes how to use the operating menu.

After switching the receiver on, the standard display is shown on the display panel.

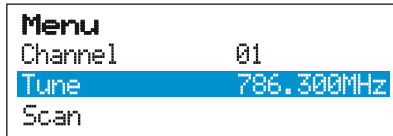

### Getting into the operating menu

- ▶ Press the **SET** button to get from the standard display into the operating menu. The last selected menu and its current setting are displayed with a background.

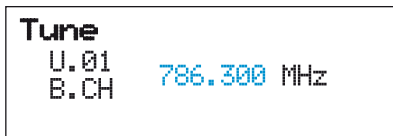

### Selecting a menu

- ▶ Press the **▲/▼** rocker button to select a menu.
- ▶ Press the **SET** button to get into the setting mode of the selected menu. The name of the menu and its current setting are displayed.

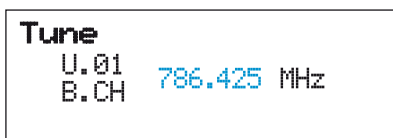

### Adjusting a setting

- ▶ Press the **▲/▼** rocker button to adjust the setting. The new setting becomes effective immediately. By briefly pressing the **▲/▼** rocker button, the display jumps either forwards or backwards to the next setting. In the "Channel", "Tune" and "Name" menu, the **▲/▼** rocker button features a "fast search" function. If you hold down a button, the display cycles continuously, allowing you to get fast and easily to your desired setting.



### Storing a setting

- ▶ Press the **SET** button to store the setting. "Stored" appears on the display, indicating that the setting has been stored. The display then returns to the top menu level.



### Exiting the operating menu

- ▶ Select the "Exit" menu to exit the operating menu and to return to the standard display.

When in the operating menu, briefly pressing the **ON** button will cancel your entry (ESC function) and return you to the standard display with the last stored settings.

# Operating menu of the receiver

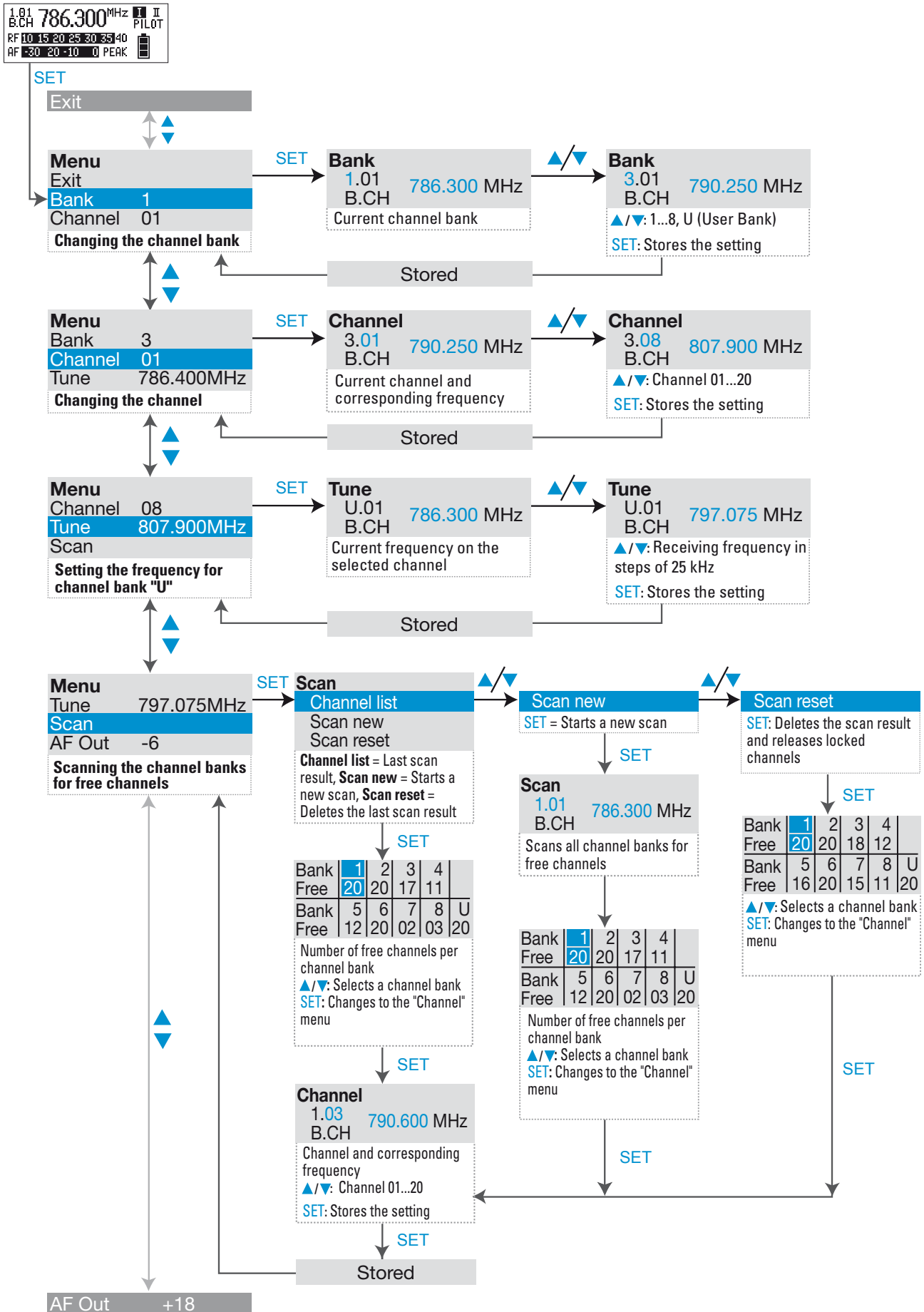



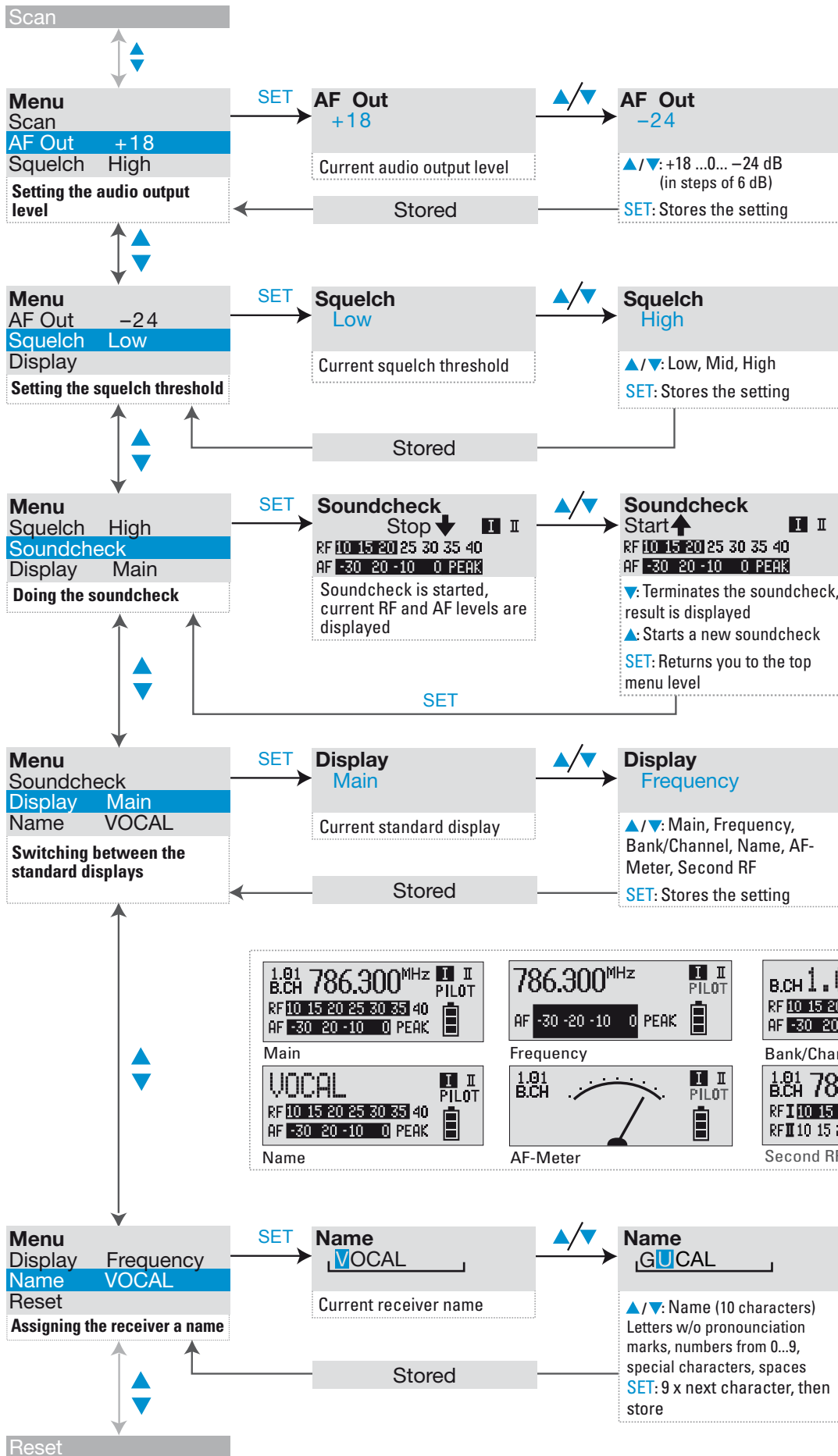

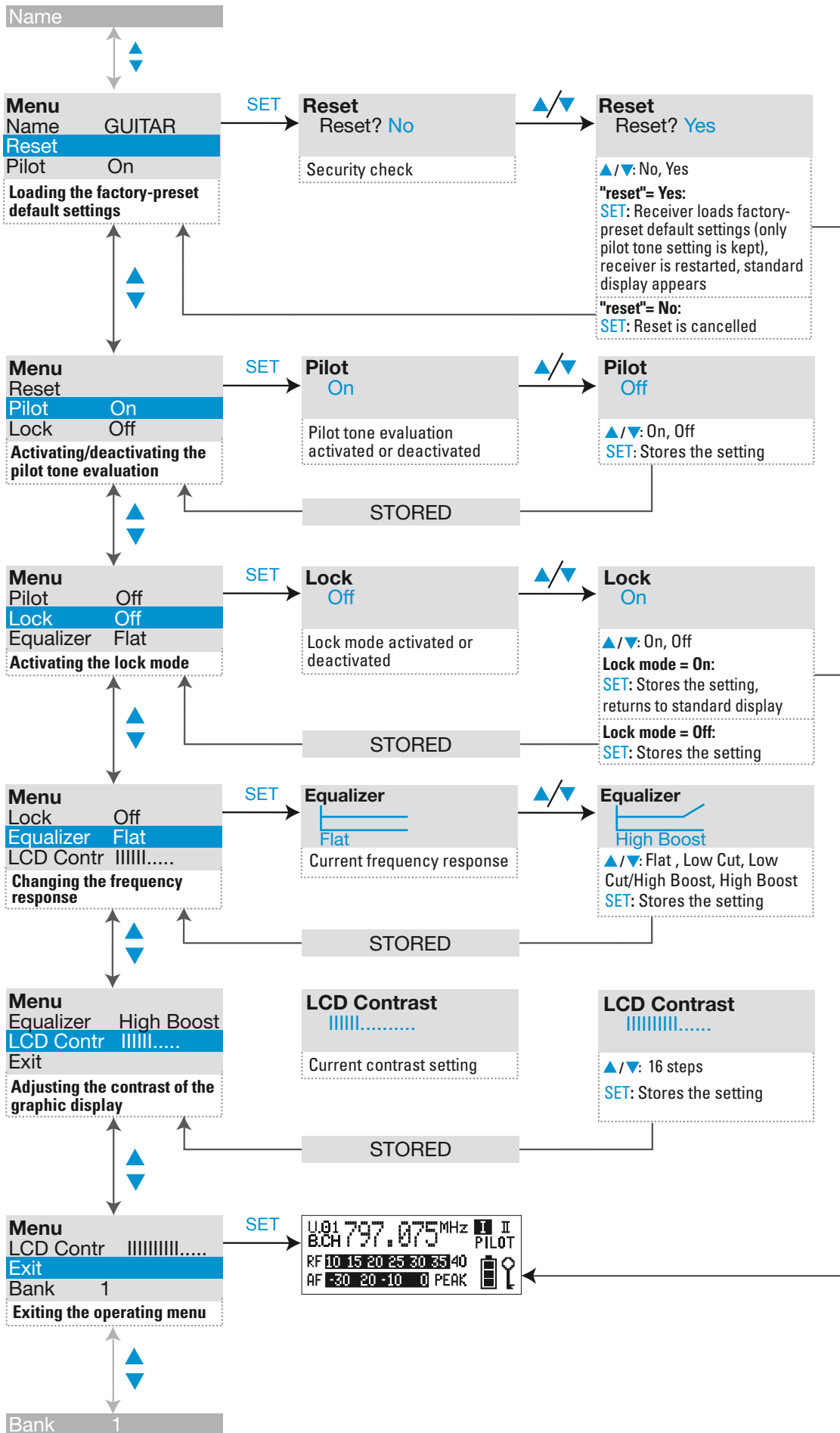

# Adjustment tips for the operating menu

## Switching between channel banks

### Bank

Via the “**Bank**” menu, you can switch between the receiver’s nine channel banks. The channel banks “1” to “8” have up to 20 switchable channels that are factory-preset to a receiving frequency (see “The channel bank system” on page 4). The channel bank “U” (user bank) has up to 20 switchable channels to store your selection out of 1440 receiving frequencies that are freely selectable within the preset frequency range.

When switching from one channel bank to another, the channel with the lowest channel number is automatically displayed. If, during the last scan of this channel bank, an interfering frequency was detected on the channel with the lowest channel number, the receiver display panel automatically displays the next free channel.

## Switching between the channels in a channel bank

### Channel

Via the “**Channel**” menu, you can switch between the different channels in a channel bank. When switching between the channels, please observe the following:

- Always set the transmitter and the receiver of a transmission link to the same channel.
- After scanning the channel banks (see “Scanning the channel banks for free channels” on page 19), only the free channels can be chosen on the receiver. Set the transmitter and the receiver to one of the free channels.

## Selecting the frequencies to be stored in the channel bank “U”

### Tune

Via the “**Tune**” menu, you can select the frequencies to be stored in the channel bank “U” (user bank).

When you have selected one of the channel banks “1” to “8” and then select the “**Tune**” menu, the receiver automatically switches to channel 01 of the channel bank “U”. In this case, “U.01” briefly appears on the display.

- ▶ Use the ▲/▼ rocker button to select the desired receiving frequency. Receiving frequencies are tunable in 25-kHz steps within a switching bandwidth of 36 MHz max. For intermodulation-free frequencies, please refer to the enclosed frequency table.

## Scanning the channel banks for free channels

### Scan

Before putting one or several ew 500 G2 transmission links into operation, you should scan the channel banks for free channels.

## Scan

### Channel list

Scan new  
Scan reset

Bank	1	2	3	4	
Free	20	20	17	11	
Bank	5	6	7	8	U
Free	12	20	02	03	20

## Channel

1.01 786.300 MHz  
B.CH

### Displaying a list of all free channels

Via the "Channel list" menu, you can display the number of free channels for all channel banks.

- ▶ Select the "Scan" menu.
- ▶ Select "Channel list" to display the last scan result. The illustrated list is an example list and may look different in other frequency ranges. The number of free channels is displayed for all channel banks.

- ▶ For further details, select a channel bank by using the ▲/▼ rocker button and then press the SET button. This gets you into the "Channel" menu where you can select a channel of this channel bank or display the frequency of a channel.

### Starting the scan

- ▶ Before starting the scan, switch all transmitters of your system off, since channels used by switched-on transmitters will not be displayed as "free channels".
- ▶ Select the "Scan" menu.
- ▶ Select "Scan new" and confirm your selection by pressing the SET button.

#### Note:

The scanning process takes approx. 1 minute.

After the scan is completed, the number of free channels is displayed for all channel banks. Channels that are used or subject to interference are locked and cannot be selected. The same result is displayed when selecting the "Channel list" menu.

- ▶ For further details, select a channel bank by using the ▲/▼ rocker button and then press the SET button. This gets you into the "Channel" menu where you can select a channel of this channel bank or display the frequency of a channel.

### Releasing locked channels

- ▶ Select the "Scan" menu.
- ▶ Select "Scan reset" and confirm your selection by pressing the SET button. The last scan result is deleted and all channels can now be selected again.

## Scan

### Channel list

Scan new  
Scan reset

Bank	1	2	3	4	
Free	20	20	17	11	
Bank	5	6	7	8	U
Free	12	20	02	03	20

## Scan

### Channel list

Scan new  
Scan reset

Bank	1	2	3	4	
Free	20	20	18	12	
Bank	5	6	7	8	U
Free	16	20	15	11	20

## Multi-channel operation

Combined with ew 500 G2 transmitters, the receiver can form transmission links that can be used in multi-channel systems. For multi-channel operation, only use the free channels in a channel bank.

Before putting the transmission links into operation, we recommend performing an auto scan.

- ▶ Scan the receiver for free channels.

Bank	1	2	3	4	
Free	20	20	17	11	
Bank	5	6	7	8	U
Free	12	20	02	03	20

- ▶ Select a channel bank with a sufficient number of free channels.
- ▶ Set all transmitter/receiver pairs in you multi-channel system to the free channels in this channel bank.

## Adjusting the audio output level

### AF Out

Via the “AF OUT” menu, you can adjust the audio output level of the receiver. The level can be adjusted in eight steps. Adapt the level of the audio output (AF OUT) to the input of the connected unit. The following figures are a guide to the best settings:

Line level input: 0 to +18 dB

Microphone level input: –24 to –6 dB

## Adjusting the squelch threshold

### Squelch

The receiver is equipped with a squelch that can be adjusted via the “Squelch” menu. The squelch eliminates annoying noise when the transmitter is switched off. It also suppresses sudden noise when there is no longer sufficient transmitter power received by the receiver.

#### Note:

Before adjusting the squelch threshold to a different setting, set the volume on a connected amplifier to the minimum.

There are three possible squelch settings:

- Low = low
- Mid = middle
- High = high

Selecting the setting “Low” reduces the squelch threshold, selecting the setting “High” increases the squelch threshold. Adjust the squelch threshold – with the transmitter switched off – to the lowest possible setting that suppresses hissing noise.

#### IMPORTANT! Notes:

If the squelch threshold is adjusted too high, the transmission range will be reduced. Therefore, always adjust the squelch threshold to the lowest possible setting.

When in the setting mode of the “Squelch” menu, pressing the ▼ button (DOWN) for more than three seconds will switch the squelch off. “Off” appears on the display. If no RF signal is being received, hissing noise will occur. This setting is for test purposes only.

## Doing the soundcheck

### Soundcheck

By doing a soundcheck, you can check the reception area for field strength gaps (“dropouts”) which cannot be compensated for by the receiver’s diversity circuitry. You can do the soundcheck without the help of another person.

- ▶ Switch the transmitter on.



- ▶ Select the "Soundcheck" menu. The soundcheck is started immediately.
- ▶ With the transmitter, walk up and down the transmission area.
- ▶ Press the ▼ button on the receiver to terminate the soundcheck and to display the result of the soundcheck. The level displays "RF" and "AF" will indicate the lowest RF and the highest AF level of the received transmitter.

Optimize the RF level by repositioning the receiving antennas.

The audio level should be as high as possible (max. 0 dB) without the level display for audio signal "AF" showing full deflection (see the section "Adjusting the sensitivity" in the operating manual of the transmitter).

If both receiving antennas are connected and aligned, the diversity displays I and II appear on the display panel.

If no transmitter is being received, the "MUTE" display appears on the display panel.

- ▶ To do another soundcheck (e.g. with an improved antenna arrangement, another transmitter position or a new transmitter sensitivity), press the ▲ button.

## Selecting the standard display

### Display

Via the "Display" menu, you can select the standard display:

Selectable standard display	Contents of the display
"Main" (standard display)	
"Frequency" (display of the frequency)	
"Bank/Channel" (display of the channel bank and channel number)	
"Name" (display of the freely selectable name)	
"AF meter" (graphic display of the AF level)	
"Second RF" (display of the RF levels of the two diversity sections)	

## Entering a name

### Name

Via the "Name" menu, you can enter a freely selectable name for the receiver. You can, for example, enter the name of the performer for whom the adjustments have been made.

The name can be displayed on the standard display and can consist of up to ten characters such as:

- letters (without pronunciation marks),
- numbers from 0 to 9,
- special characters e.g. () - . \_ and spaces.

To enter a name, proceed as follows:

- ▶ Press the **SET** button to get into the setting mode of the "Name" menu. The first segment starts flashing on the display.
- ▶ With the **▲/▼** buttons you can now select a character. By briefly pressing a button, the display jumps either forwards or backwards to the next character. If you hold down a button, the display starts cycling continuously.
- ▶ Press the **SET** button to change to the next segment and select the next character.
- ▶ Have you entered the name completely? Press the **SET** button to store your setting and to return to the top menu level.

## Loading the factory-preset default settings

### Reset

Via the "Reset" menu, you can load the factory-preset default settings. Only the selected setting for the pilot tone remains unchanged. After the reset, the receiver is restarted and the standard display is shown on the display panel.

## Activating/deactivating the pilot tone evaluation

### Pilot

Via the "Pilot" menu, you can activate or deactivate the pilot tone evaluation.

The pilot tone supports the receiver's squelch function (Squelch) and protects against interference due to RF signals from other units. The transmitter adds an inaudible signal, known as the pilot tone, to the transmitted signal. The receiver detects and evaluates the pilot tone, and is thus able to identify the signal of the matching transmitter and mute all others.

Transmitters of the ew 500 series (first generation) do not transmit a pilot tone and the receivers of the ew 500 series (first generation) cannot evaluate the pilot tone. Nevertheless, you can combine the EM 500 G2 receiver with a transmitter of the first generation. However, when combining units, please observe the following:

- With an ew 500 G2 transmitter and the ew 500 G2 receiver:  
Activate the pilot tone function with both transmitter and receiver.
- With an ew 500 transmitter and the ew 500 G2 receiver or vice versa:  
Deactivate the pilot tone function with the ew 500 G2 transmitter or receiver.

## Activating/deactivating the lock mode

### Lock

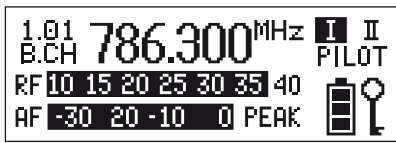

Via the “Lock” menu, you can activate or deactivate the lock mode.



The lock mode prevents that the receiver is accidentally programmed or switched off during operation. The lock mode icon on the display indicates that the lock mode is activated.

To deactivate the lock mode, first press the **SET** button and then press the **▲/▼** buttons to select “Off”. If you confirm your selection by pressing the **SET** button, the buttons can be operated as usual.

## Using the equalizer

### Equalizer

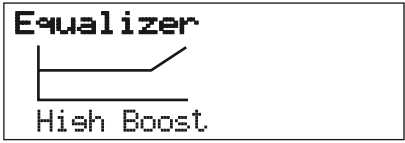
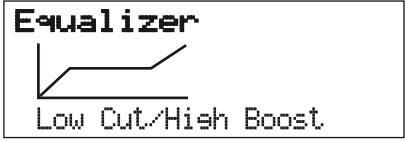
Via the “Equalizer” menu, you can change the treble and bass of the audio signal available at the audio output (AF OUT):

Selectable setting	Display
“Flat” (treble and bass of the output signal remain unchanged)	 <p>Equalizer Flat</p>
“High Boost” (boosting the treble)	 <p>Equalizer High Boost</p>
“Low Cut/High Boost” (cutting the bass and boosting the treble)	 <p>Equalizer Low Cut/High Boost</p>
“Low Cut” (cutting the bass)	 <p>Equalizer Low Cut</p>

## Adjusting the contrast of the graphic display

### LCD Contr

Via the “LCD Contr” menu, you can adjust the contrast of the graphic display in 16 steps.

## Exiting the operating menu

### Exit

Via the “Exit” menu, you can exit the operating menu and return to the standard display.



# Troubleshooting

## Error checklist

Problem	Possible cause	Possible solution
No operation indication	No mains connection	Check the connections of the mains unit
No RF signal	Transmitter and receiver are not on the same channel	Set transmitter and receiver to the same channel
	Transmitter is out of range	Check the squelch threshold setting (see "Adjusting the squelch threshold" on page 21) or reduce the distance between transmitter and receiving antenna
RF signal available, no audio signal, "MUTE" display appears on the display panel	Transmitter is muted ("MUTE")	Deactivate the muting function (see operating manual of the transmitter)
	Receiver's squelch threshold is adjusted too high	See "Adjusting the squelch threshold" on page 21
	Transmitter doesn't transmit a pilot tone	Switch the pilot tone transmission on the transmitter on or switch the pilot tone evaluation on the receiver off
	Transmitter sensitivity is adjusted too low	Adjust the transmitter sensitivity correctly
Audio signal has a high level of background noise	Receiver's AF output level is adjusted too low	See "Adjusting the audio output level" on page 21
	Transmitter sensitivity is adjusted too high	Adjust the transmitter sensitivity correctly
Audio signal is distorted	Receiver's AF output level is adjusted too high	See "Adjusting the audio output level" on page 21
No access to a certain channel	During scanning, an RF signal has been detected on this channel and the channel has been locked	See "Scanning the channel banks for free channels" on page 19
	During scanning, a transmitter of your system operating on this channel has not been switched off	See "Multi-channel operation" on page 20
During the soundcheck, only one diversity display (I or II) appears on the display panel	One of the antennas is not connected correctly	Check the antenna connections

If problems occur that are not listed in the above table or if the problems cannot be solved with the proposed solutions, please contact your local Sennheiser agent for assistance.

## Recommendations and tips

### ... for optimum reception

- Transmission range depends to a large extent on location and can vary from about 10 m to about 150 m. There should be a "free line of sight" between transmitting and receiving antennas.
- If, with the EM 500 G2 receiver, reception conditions are unfavourable, you should use two remote antennas which are connected via antenna cable.
- To avoid overmodulating the receiver, observe a minimum distance of 5 m between transmitting and receiving antennas.
- Observe a minimum distance of 50 cm between receiving antennas and metal objects (such as cross members or reinforced-concrete walls).

### ... for multi-channel operation

- For multi-channel operation, you can only use the channels in a channel bank. Each of the channel banks "1" to "8" accommodates up to 20 factory-preset frequencies which are intermodulation-free. For alternative frequency combinations, please refer to the enclosed frequency table. The freely selectable frequencies can be selected via the "Tune" menu and can be stored in the channel bank "U".
- When using several transmitters simultaneously, interference can be avoided by maintaining a minimum distance of 20 cm between two transmitters.
- Use special accessories for multi-channel applications (see "Accessories" on page 30).

## Care and maintenance

Use a slightly damp cloth to clean the receiver from time to time.

### Note:

Do not use any cleansing agents or solvents.

# Additional information

## HDX noise reduction

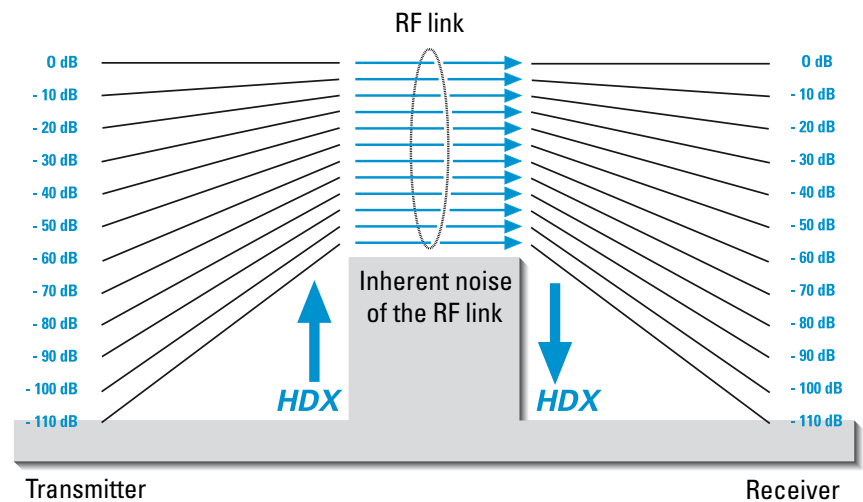

Progress you can hear:

The evolution wireless G2 series is equipped with **HDX**, the Sennheiser noise reduction system that reduces RF interference. It increases the signal-to-noise ratio in wireless audio transmission to more than 110 dB.

**HDX** is a wideband compander system which compresses the audio signal in the transmitter in a 2:1 ratio (related to dB) to lift it above the inherent noise floor of the RF link. A 110 dB dynamic range signal is thus transmitted with an effective dynamic range of only 55 dB, which is above the 60 dB noise floor of the RF link. In the receiver the signal is expanded in an identical and opposite way in a 1:2 ratio to restore the original signal, at the same time reducing the RF noise to below the noise floor of the receiver.

**HDX** has been specially developed for high quality radiomicrophone systems.

### Note:

Only transmitters and receivers that are equipped with **HDX** can work correctly with each other. If non **HDX** equipment was mixed with **HDX**, the dynamic range would be drastically reduced and the transmission would sound blunt and flat. **HDX** is permanently active and cannot be switched off.

## Wireless transmission systems

With the ew 500 G2 series, Sennheiser puts an end to cable tangles and enables complete freedom of movement. The systems operate exclusively in the UHF band. UHF transmission is extremely reliable and is far less prone to interference than the overcrowded VHF band – harmonics from mains units, fluorescent tubes, refrigerators, computers, etc. are virtually eliminated. Also indoor propagation of UHF radio waves is better than VHF so that the RF power can be kept low – this is also an advantage when using multi-channel systems. Finally, UHF frequency ranges are being approved all over the world for radiomicrophone usage – in some countries licence-free.

## Squelch

### Pilot tone squelch

The ew 500 G2 transmitters adds a pilot tone to the audio signal. The receiver checks incoming audio signals to see if the pilot tone is present. In the absence of the pilot tone, the receiver's audio output will remain muted, even if a strong RF signal is present.

This prevents strong interfering signals from causing hissing noise in the receiver when the transmitters are switched off.

In order to benefit from this feature, the pilot tone function must be activated on both the transmitter and the receiver. The receiver's pilot tone function is factory-preset to "ON" (= activated).

### Field strength-dependent squelch

Depending on the strength of the received RF signal, the receiver's audio output is opened or muted. Via the "Squelch" menu of the receiver, the squelch threshold can be adjusted in three steps (Low, Mid, High).

## Diversity reception

The receiver operates on the "true diversity" principle:

A receiving antenna receives not only the electromagnetic waves which reach it by a direct path, but also the reflections of these waves which are created in the room by walls, windows, ceilings and fittings. When these waves are superimposed, destructive interference occurs, which can also be called "field strength gaps". Repositioning the receiving antenna can bring a solution. With mobile transmitters, however (which all radiomicrophones are), the "field strength gap" will then occur with a different transmitter position. These "field strength gaps" can only be eliminated with true diversity receivers.

In true diversity, instead of one antenna and one receiver there are now two antennas and two receiver sections. The antennas are spatially separated. By means of a comparison circuit, the receiver section with the strongest RF signal is always switched to the common AF output. The risk of the occurrence of "field strength gaps" in both antennas at the same time is virtually nonexistent.

The receiver display panel shows the active diversity section (I or II) ⑥.

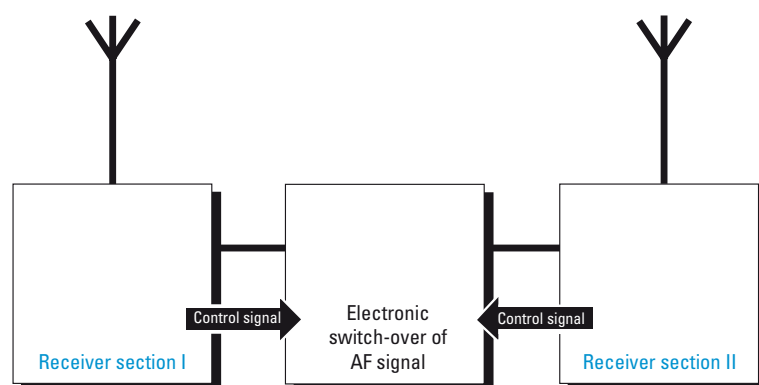
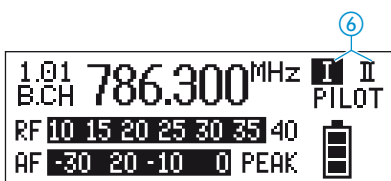

# Specifications

## RF characteristics

Modulation	wideband FM
Frequency ranges	518–554, 626–662, 740–776, 786–822, 830–866 MHz
Receiving frequencies	8 channel banks with up to 20 factory-preset channels each 1 channel bank with up to 20 freely selectable channels (1440 frequencies, tunable in steps of 25 kHz)
Switching bandwidth	36 MHz
Nominal/peak deviation	$\pm 24$ kHz / $\pm 48$ kHz
Frequency stability	$\leq \pm 15$ ppm
Receiver principle	true diversity
Sensitivity (with <b>HDX</b> , peak deviation)	$< 2.5$ $\mu$ V at 52 dBA <sub>rms</sub> S/N ratio
Adjacent channel rejection	$\geq 70$ dB
Intermodulation attenuation	$\geq 70$ dB
Blocking	$\geq 75$ dB
Squelch	4 steps: Off Low: 5 dB $\mu$ V Mid: 15 dB $\mu$ V High: 25 dB $\mu$ V
Pilot tone squelch	can be switched off
Antenna inputs	2 BNC sockets

## AF characteristics

Noise reduction system	Sennheiser <b>HDX</b>
EQ presets (switchable, effect the line and monitor outputs):	
Preset 1: "Flat"	
AF frequency response	40–18,000 Hz
Preset 2: "Low Cut"	Cut approx. -3 dB at 200 Hz
Preset 3: "HiBoost"	Boost approx. +6 dB at 10,000 Hz
Preset 4: "Low Cut & Hi Boost"	Cut approx. -3 dB at 200 Hz Boost approx. +6 dB at 10,000 Hz
S/N ratio (at 1 mV and peak deviation)	$\geq 115$ dB(A) (AF OUT)
THD (at nominal deviation and 1 kHz)	$\leq 0.9$ %
AF output voltage (at peak deviation 1 kHz <sub>AF</sub> )	1/4" (6.3 mm) jack socket (unbalanced): +12 dB <sub>u</sub> XLR socket (balanced): +18 dB <sub>u</sub>
<b>Overall unit</b>	
Temperature range	-10 °C to +55 °C
Power supply	10.5–16 V DC, nominal voltage 12 V DC
Power consumption	approx. 300 mA
Dimensions [mm]	212 x 145 x 38
Weight	approx. 1100 g

## Connector assignment

1/4" (6.3 mm) stereo jack plug, unbalanced

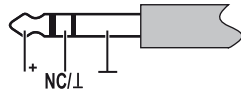

DC connector for power supply



1/4" (6.3 mm) mono jack plug, unbalanced

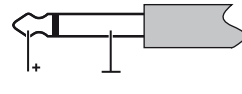

1/4" (6.3 mm) stereo jack plug for headphone output

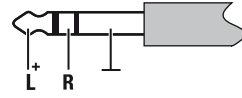

XLR-3F connector, balanced

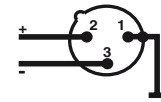

## Accessories

<b>AM 2</b>	Antenna mount for mounting antennas to the front of the GA 2	
<b>A 1031-U</b>	UHF antenna, passive, omni-directional, can be mounted onto a stand	
<b>AB 2-A</b>	UHF antenna booster, 10 dB gain powered via ASP 2/NT 1	518–554 MHz
<b>AB 2-B</b>		626–662 MHz
<b>AB 2-C</b>		740–776 MHz
<b>AB 2-D</b>		786–822 MHz
<b>AB 2-E</b>		830–866 MHz
<b>GZL 1019-A1 / 5 / 10</b>	Antenna cable with BNC connectors	1 m / 5 m / 10 m
<b>ASP 2</b>	Antenna splitter, 2 x 1:4, passive, for connecting eight EM 500 G2 to two A 1031-U/AB 2	
<b>NT 1</b>	Mains unit for ASP 2	

# Manufacturer declarations

## Warranty regulations

The guarantee period for this Sennheiser product is 24 months from the date of purchase. Excluded are accessory items, rechargeable or disposable batteries that are delivered with the product; due to their characteristics these products have a shorter service life that is principally dependent on the individual frequency of use.

The guarantee period starts from the date of original purchase. For this reason, we recommend that the sales receipt be retained as proof of purchase. Without this proof (which is checked by the responsible Sennheiser service partner) you will not be reimbursed for any repairs that are carried out.

Depending on our choice, guarantee service comprises, free of charge, the removal of material and manufacturing defects through repair or replacement of either individual parts or the entire device. Inappropriate usage (e.g. operating faults, mechanical damages, incorrect operating voltage), wear and tear, force majeure and defects which were known at the time of purchase are excluded from guarantee claims. The guarantee is void if the product is manipulated by non-authorized persons or repair stations.

In the case of a claim under the terms of this guarantee, send the device, including accessories and sales receipt, to the responsible service partner. To minimise the risk of transport damage, we recommend that the original packaging is used. Your legal rights against the seller, resulting from the contract of sale, are not affected by this guarantee.

The guarantee can be claimed in all countries outside the U.S. provided that no national law limits our terms of guarantee.

## CE Declaration of Conformity

CE 0682 ⓘ

This equipment is in compliance with the essential requirements and other relevant provisions of Directives 1999/5/EC, 89/336/EC or 73/23/EC. The declaration is available on the internet site at [www.sennheiser.com](http://www.sennheiser.com).

Before putting the device into operation, please observe the respective country-specific regulations!

## Batteries or rechargeable batteries



The supplied batteries or rechargeable batteries can be recycled. Please dispose of them as special waste or return them to your specialist dealer. In order to protect the environment, only dispose of exhausted batteries.

## WEEE Declaration



Your Sennheiser product was developed and manufactured with high quality materials and components which can be recycled and/or reused. This symbol indicates that electrical and electronic equipment must be disposed of separately from normal waste at the end of its operational lifetime.

Please dispose of this product by bringing it to your local collection point or recycling centre for such equipment. This will help to protect the environment in which we all live.



Sennheiser electronic GmbH & Co. KG  
30900 Wedemark, Germany  
Phone +49 (5130) 600 0  
Fax +49 (5130) 600 300  
[www.sennheiser.com](http://www.sennheiser.com)



## Free Manuals Download Website

<http://myh66.com>

<http://usermanuals.us>

<http://www.somanuals.com>

<http://www.4manuals.cc>

<http://www.manual-lib.com>

<http://www.404manual.com>

<http://www.luxmanual.com>

<http://aubethermostatmanual.com>

Golf course search by state

<http://golfingnear.com>

Email search by domain

<http://emailbydomain.com>

Auto manuals search

<http://auto.somanuals.com>

TV manuals search

<http://tv.somanuals.com>