

 **SENNHEISER**



SK 2000

Instruction manual

Contents

Important safety instructions	2
The SK 2000 bodypack transmitter	3
Areas of application	3
The frequency bank system	4
Delivery includes	5
Product overview	6
Overview of the SK 2000 bodypack transmitter	6
Overview of the displays	7
Putting the bodypack transmitter into operation	8
Inserting the batteries/accupack	8
Charging the accupack	8
Connecting the microphone cable/instrument cable	9
Attaching the bodypack transmitter to clothing	10
Using the bodypack transmitter	11
Switching the bodypack transmitter on/off	11
Deactivating the lock mode temporarily	12
Muting the audio signal or deactivating the RF signal	13
Selecting a standard display	15
Using the operating menu	16
The buttons	16
Overview of the operating menu	16
Working with the operating menu	18
Adjusting settings via the operating menu	20
The main menu "Menu"	20
The extended menu "Advanced Menu"	23
Synchronizing the bodypack transmitter with a receiver	28
Synchronizing the bodypack transmitter with the receiver – individual operation	28
Synchronizing bodypack transmitters with receivers – multi-channel operation	28
Cleaning the bodypack transmitter	29
Recommendations and tips	30
If a problem occurs	31
Accessories	33
Specifications	34
Manufacturer Declarations	36
Index	38



For further information, visit the SK 2000 product page on our website at www.sennheiser.com.

Important safety instructions

- Read this instruction manual.
- Keep this instruction manual. Always include this instruction manual when passing the product on to third parties.
- Heed all warnings and follow all instructions in this instruction manual.
- Use only a cloth for cleaning the product.
- Do not place the product near any heat sources such as radiators, stoves, or other devices (including amplifiers) that produce heat.
- Only use attachments/accessories specified by Sennheiser.
- Refer all servicing to qualified service personnel.
Servicing is required if the product has been damaged in any way, liquid has been spilled, objects have fallen inside, the product has been exposed to rain or moisture, does not operate properly or has been dropped.
- **WARNING:** To reduce the risk of short circuits, do not use the product near water and do not expose it to rain or moisture.

Replacement parts

When replacement parts are required, be sure the service technician uses replacement parts specified by Sennheiser or those having the same characteristics as the original part. Unauthorized substitutions may result in fire, electric shock, or other hazards.

Intended use

Intended use of the SK 2000 bodypack transmitter includes:

- having read these instructions especially the chapter "Important safety instructions",
- using the product within the operating conditions and limitations described in this instruction manual.

"Improper use" means using the product other than as described in this instruction manual, or under operating conditions which differ from those described herein.

The SK 2000 bodypack transmitter

This bodypack transmitter is part of the 2000 series. With this series, Sennheiser offers high-quality state-of-the-art RF transmission systems with a high level of operational reliability and ease of use. Transmitters and receivers permit wireless transmission with studio-quality sound.



Features of the 2000 series:

- Optimized PLL synthesizer and microprocessor technology
- HDX noise reduction system
- Pilot tone squelch control
- True diversity technology
- Switching bandwidth of up to 75 MHz
- Increased immunity to intermodulation and interferences in multi-channel operation

Areas of application



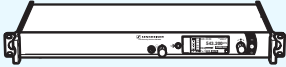



The bodypack transmitter can be combined with the EM 2000 and EM 2050 rack-mount receivers. The receivers are available in the same UHF frequency ranges and are equipped with the same frequency bank system with factory-preset frequencies. An advantage of the factory-preset frequencies is that:

- a transmission system is ready for immediate use after switch-on,
- several transmission systems can be operated simultaneously on the preset frequencies without causing intermodulation interference.

Transmitter	Optional accessories	Receivers
 <p>SK 2000</p>	<ul style="list-style-type: none"> • Clip-on microphones*: MKE 1, ME 102, ME 104, ME 105 • Headmics*: HSP 2, HSP 4 • Instrumente cable: CI 1-4* 	<p>EM 2000 receiver</p>  <p>EM 2050 twin receiver</p> 
<p>* each fitted with a 3-pin special audio connector</p>		

The SK 2000 bodypack transmitter

Overview of the microphones and instrument cables:

Microphone/instrument cable	Type	Pick-up pattern
MKE 1 clip-on microphone	condenser	 omni-directional
ME 102 clip-on microphone		 cardioid
ME 104 clip-on microphone		 cardioid
ME 105 clip-on microphone		 super-cardioid
HSP 2 headmic		 omni-directional
HSP 4 headmic		 cardioid
CI 1-4 instrument cable	—	—

The frequency bank system

The bodypack transmitter is available in 5 UHF frequency ranges with up to 3,000 transmission frequencies per frequency range:

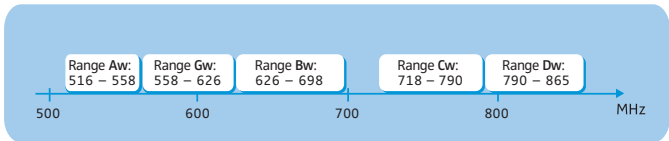

Each frequency range (Aw-Dw, Gw) offers 26 frequency banks with up to 64 channels each:

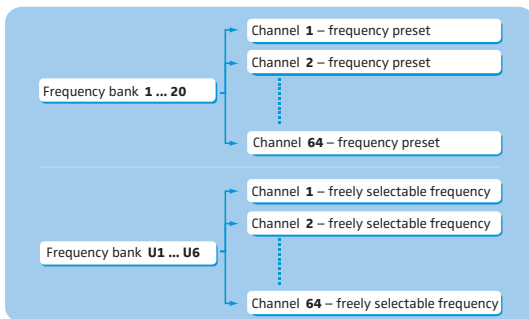

Each of the channels in the frequency banks "1" to "20" has been factory-preset to a fixed frequency (frequency preset). The factory-preset frequencies within one frequency bank are intermodulation-free. These frequencies cannot be changed.

For an overview of the frequency presets, please refer to the supplied frequency information sheet. Updated versions of the frequency information sheet can be downloaded from the SK 2000 product page on our website at www.sennheiser.com.

The frequency banks "U1" to "U6" allow you to freely select and store frequencies. It might be that these frequencies are **not** intermodulation-free.

Delivery includes

The packaging contains the following items:

- 1 SK 2000 bodypack transmitter
- 2 AA size batteries, 1.5 V
- 1 instruction manual
- 1 frequency information sheet
- 1 RF power information sheet

Product overview

Overview of the SK 2000 bodypack transmitter

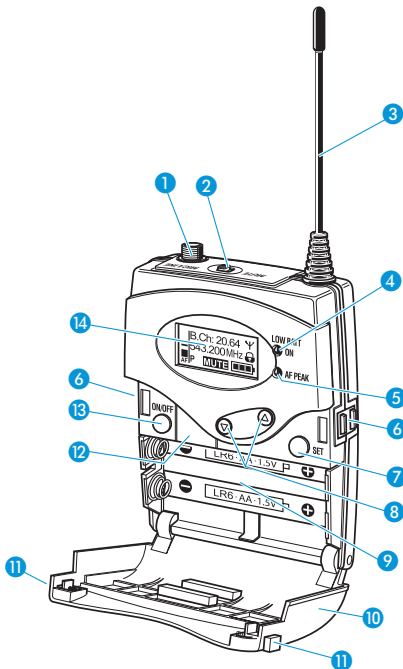



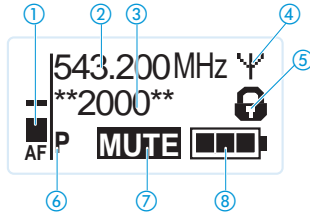

- | | |
|---|---|
| 1 Microphone/instrument input (MIC/LINE), 3-pole special audio socket, lockable | 6 Charging contacts |
| 2 MUTE switch | 7 SET button |
| 3 Antenna | 8 ▲/▼ rocker button (UP/DOWN) |
| 4 Operation and battery status indicator, red LED:
lit = ON
flashing = LOW BATT | 9 Battery compartment |
| 5 Audio overmodulation indicator, yellow LED:
lit = AF PEAK | 10 Battery compartment cover (metal) |
| | 11 Battery compartment catches |
| | 12 Infra-red interface |
| | 13 ON/OFF button with ESC function (cancel) |
| | 14 Display panel, backlit in orange |

Overview of the displays

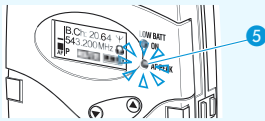
After switch-on, the bodypack transmitter displays the “Frequency/Name” standard display. For further illustrations and examples of the different standard displays, refer to page 15. The display backlighting is automatically reduced after approx. 20 seconds.

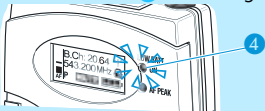

Display	Meaning
① Audio level “AF”	<p>Modulation of the bodypack transmitter with peak hold function</p> <p>When the audio input level is excessively high, the “AF” display shows full deflection and, in addition, the yellow AF PEAK LED ⑤ lights up:</p> 
② Frequency	Current transmission frequency
③ Name	Freely selectable name of the transmitter
④ Transmission icon	RF signal is being transmitted
⑤ Lock mode icon	Lock mode is activated
⑥ “P” (pilot tone)	Pilot tone transmission is activated
⑦ “MUTE”	Microphone or line input is muted
⑧ Battery status	<p>Charge status:</p> <ul style="list-style-type: none">  approx. 100%  approx. 70%  approx. 30%  charge status is critical, the red LOW BATT LED ④ is flashing: 

Putting the bodypack transmitter into operation

Inserting the batteries/accupack

For powering the bodypack transmitter, you can either use two 1.5 V AA size batteries or the rechargeable Sennheiser BA 2015 accupack (see "Accessories" on page 33).

- ▶ Open the battery compartment by pushing the two catches **11** in the direction of the arrows and open the cover **10**.

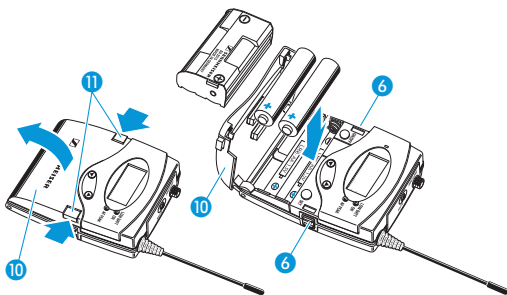

- ▶ Insert the two batteries or the accupack as shown above. Please observe correct polarity when inserting the batteries/accupack.
- ▶ Close the battery compartment. The battery compartment cover **10** locks into place with an audible click.

Charging the accupack

To charge the bodypack transmitter with the BA 2015 accupack (see "Accessories" on page 33) installed:

- ▶ Insert the bodypack transmitter into the L 2015 charger (see "Accessories" on page 33).



The L 2015 charger can only charge the combination BA 2015 accupack/bodypack transmitter. Standard batteries (primary cells) or individual rechargeable battery cells cannot be charged.

Connecting the microphone cable/instrument cable

The audio input is designed for the connection of both condenser microphones and instruments (e.g. guitars). DC powering of the condenser microphones is via the audio input **MIC/LINE 1** (3-pole special audio socket).

- ▶ Use one of the recommended Sennheiser microphones or the CI 1-4 instrument cable (see "Accessories" on page 33).
- ▶ Connect the 3-pin special audio connector **15** from the Sennheiser microphone or instrument cable to the socket **MIC/LINE 1**.

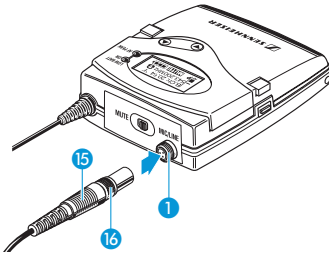

- ▶ Lock the 3-pin special audio connector by screwing down the coupling ring **16**.
- ▶ Via the operating menu, adjust the sensitivity of the microphone/line input (see page 20).

Attaching the bodypack transmitter to clothing

You can use supplied bodypack pouch or the belt clip 18 to attach the bodypack transmitter to clothing (e.g. belt, waistband).

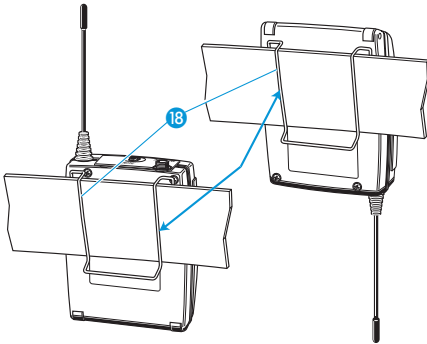

The belt clip is detachable so that you can also attach the transmitter with the antenna pointing downwards. To do so, withdraw the belt clip 18 from its fixing points and attach it the other way round.

The belt clip 18 is secured so that it cannot slide out of its fixing points accidentally.

To detach the belt clip:

- ▶ Lift the belt clip as shown.

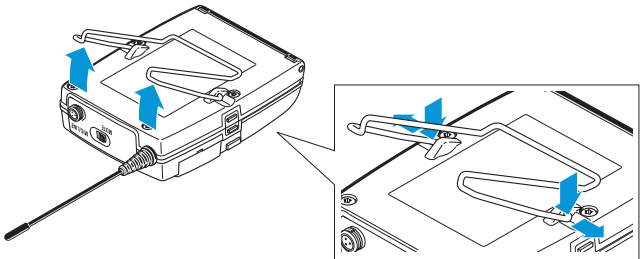

- ▶ Press down the belt clip at one fixing point and pull it out of the transmitter housing.
- ▶ Repeat for the other side.

Using the bodypack transmitter

To establish a transmission link, proceed as follows:

1. Switch the receiver on (see the instruction manual of the receiver).
2. Switch the bodypack transmitter on (see next section).
The transmission link is established and the display backlighting of the receiver changes from red to orange.



It is vital to observe the notes on frequency selection on page 28.

If you cannot establish a transmission link between transmitter and receiver, read the chapter "Synchronizing the bodypack transmitter with a receiver" on page 28.

Switching the bodypack transmitter on/off

- ▶ Push the two battery compartment catches **11** and open the battery compartment cover **10**.

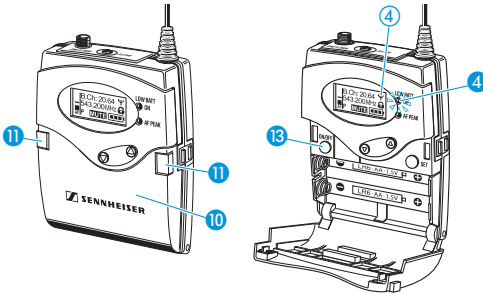

To switch the bodypack transmitter **on** (online operation):

ON/OFF

- ▶ Briefly press the ON/OFF button **13**.



The bodypack transmitter transmits an RF signal. The "Frequency/Name" standard display appears on the display panel. The red ON LED **4** lights up and the transmission icon **4** is displayed.

To switch the bodypack transmitter **on** and to deactivate the RF signal on **switch-on** (offline operation):

ON/OFF

- ▶ Keep the ON/OFF button **13** pressed until "RF Mute On?" appears on the display panel.





- ▶ Press the **SET** button.

The transmission frequency is displayed but the bodypack transmitter does not transmit an RF signal. The transmission icon ④ is not displayed. When the pilot tone function is activated on both bodypack transmitter and receiver, “RF Mute” appears on the receiver’s display panel.

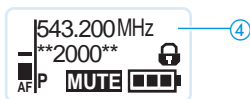

Use this function to save battery power or to prepare a bodypack transmitter for use during live operation without causing interference to existing transmission links.

To **activate** the RF signal:

ON/OFF

- ▶ Press the **ON/OFF** button.

“RF Mute Off” appears on the display panel.



SET

- ▶ Press the **SET** button.

The transmission icon ④ is displayed again.



To switch the bodypack transmitter **off**:

- ▶ If necessary, deactivate the lock mode (see next chapter).

ON/OFF

- ▶ Keep the **ON/OFF** button ⑬ pressed until “OFF” appears on the display panel. The red **ON** LED ④ goes off and the display panel turns off.



When in the operating menu, pressing the **ON/OFF** button ⑬ will cancel your entry (ESC function) and return you to the current standard display.

Deactivating the lock mode temporarily

You can activate or deactivate the automatic lock mode via the “Auto Lock” menu item (see page 23). If the lock mode is activated, you have to temporarily deactivate it in order to be able to operate the bodypack transmitter:



- ▶ Press the **SET** button or the **ON/OFF** button.

“Locked” appears on the display panel.



- ▶ Press the rocker button.

“Unlock?” appears on the display panel.



- ▶ Press the **SET** button.

The lock mode is temporarily deactivated.

- When you are in the operating menu, the lock mode remains deactivated until you exit the operating menu.
- When one of the standard displays is shown, the lock mode is automatically activated after 10 seconds.

The lock mode icon ⑤ flashes prior to the lock mode being activated again.



Muting the audio signal or deactivating the RF signal

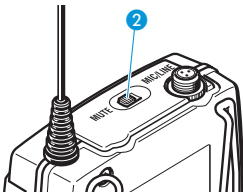

The **MUTE** switch ② allows you to mute the audio signal or to deactivate the RF signal. Via the “**Mute Mode**” menu item, you can set the desired function of the **MUTE** switch ② (see page 25).

Setting	Slide the MUTE switch ② ...	Function
“AF On/Off”	... to the left (position MUTE)	Mutes the audio signal
	... to the right	Unmutes the audio signal
“RF On/Off”	... to the left (position MUTE)	Deactivates the RF signal (offline operation)
	... to the right	Activates the RF signal (online operation)
“Disabled”	No function	

- ▶ From the “**Mute Mode**” menu item, select the desired setting (see page 25).
- ▶ Exit the operating menu.
- ▶ Slide the **MUTE** switch ② to the left, to the position **MUTE**. The bodypack transmitter reacts as indicated in the table.

Using the bodypack transmitter

The current state of the muting function or the RF signal is displayed on the display panel of the bodypack transmitter.



An additional display of the muting function appears on the receiver's display panel when

- the pilot tone function is activated on both bodypack transmitter and receiver
and, in addition,
- this display has been activated via the "Warnings" menu item on the receiver (see the instruction manual of the receiver).

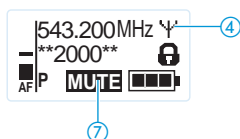

Audio signal is muted

Transmitter's display panel: "MUTE" (7) is displayed

Receiver's display panel: "TX Mute" is displayed*

* only when activated on the receiver (see previous section)

Audio signal is activated (muting is deactivated)

Transmitter's display panel: "MUTE" (7) is not displayed

Receiver's display panel: "TX Mute" is not displayed

RF signal is deactivated

Transmitter's display panel: Transmission icon (4) is not displayed, "MUTE" (7) is displayed

Receiver's display panel: "RF Mute" is displayed*

* only when activated on the receiver (see previous section)

RF signal is activated

Transmitter's display panel: Transmission icon (4) is displayed

Receiver's display panel: "RF Mute" is not displayed



You can also deactivate the RF signal on switch-on. For more information, refer to the chapter “Switching the bodypack transmitter on/off” on page 11.

Using the **ON/OFF** button, you can also activate/deactivate the RF signal during operation. To do so, briefly press the **ON/OFF** button and proceed as described on page 12.

Selecting a standard display



▼ ▲ ▶ Press the rocker button to select a standard display:

Contents of the display	Selectable standard display
	“Frequency/Name”
	“Channel/Frequency”
	“Name/Channel”

Using the operating menu

A special feature of the Sennheiser 2000 series is the consistent, intuitive menu structure of transmitters and receivers. As a result, adjustments to the settings can be made quickly – even in stressful situations, for example on stage or during a live show or presentation.

The buttons

Button	Function of the button
Press the ON/OFF button 	<ul style="list-style-type: none"> • Switches the bodypack transmitter on and off • Cancels the entry and returns to the current standard display (ESC function) • Activates/deactivates the RF signal (special function, see page 13)
Press the SET button 	<ul style="list-style-type: none"> • Changes from the current standard display to the operating menu • Calls up a menu item • Enters a submenu • Stores the settings and returns to the operating menu
Press the rocker button 	<ul style="list-style-type: none"> • Selects a standard display • Changes to the next/previous menu item • Changes the setting of a menu item

Overview of the operating menu

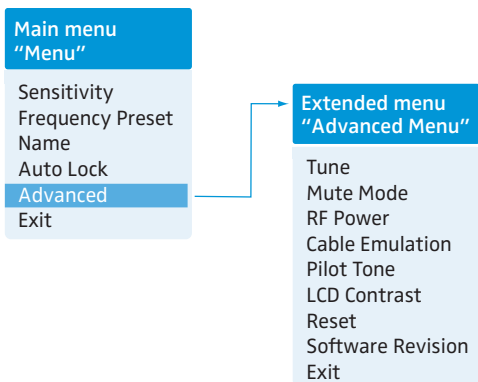

Display	Function of the menu item	Page
Main menu "Menu"		
Sensitivity	Adjusts the sensitivity "AF"	20
Frequency Preset	Sets the frequency bank and the channel	21
Name	Enters a freely selectable name	22
Auto Lock	Activates/deactivates the lock mode	23
Advanced	Calls up the extended menu "Advanced Menu"	23
Exit	Exits the operating menu and returns to the current standard display	
Extended menu "Advanced Menu"		
Tune	Sets the transmission frequencies for the frequency banks "U1" to "U6"	24
	Sets the frequency bank, the channel and the transmission frequency (frequency banks "U1" to "U6")	24
Mute Mode	Sets the mode for the MUTE switch ②	25
RF Power	Adjusts the transmission power	25
Cable Emulation	Emulates guitar cable capacities	26
Pilot Tone	Activates/deactivates the pilot tone transmission	26
LCD Contrast	Adjusts the contrast of the display panel	26
Reset	Resets the settings made in the operating menu	27
Software Revision	Displays the current software revision	27
Exit	Exits the extended menu "Advanced Menu" and returns to the main menu	–

Working with the operating menu



If the lock mode is activated, you have to deactivate it in order to be able to work with the operating menu (see page 12).

By way of example of the "Sensitivity" menu, this section describes how to use the operating menu.

Changing from a standard display to the operating menu

-  Press the **SET** button.
The current standard display is replaced by the main menu.
The last selected menu item is displayed.

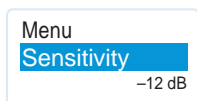

Selecting a menu item

-  Press the rocker button to change to the "Sensitivity" menu item.
The current setting of the selected menu item is displayed:

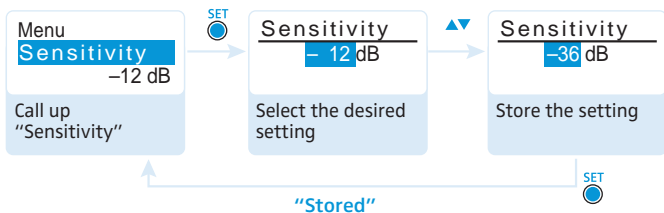

Changing and storing settings



-  Press the **SET** button to call up the menu item.
-  Press the rocker button to adjust the input sensitivity.
-  Press the **SET** button to store the setting.

Canceling an entry

- ON/OFF** ▶ Press the **ON/OFF** button to cancel the entry.
The current standard display appears on the display panel.



To subsequently return to the last edited menu item:

- SET** ▶ Press the **SET** button repeatedly until the last edited menu item appears.



Exiting a menu item

- ▼▲ ▶ Change to the “Exit” menu item.

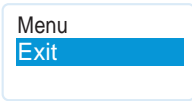

- SET** ▶ Confirm your selection.
You return to the next higher menu level.



To directly return to the current standard display:

- ON/OFF** ▶ Press the **ON/OFF** button.



Adjusting settings via the operating menu



Make use of the possibility to adjust settings via the operating menu of your receiver and to transfer these settings to the body-pack transmitter.

For more information, refer to the instruction manual of the receiver. The relevant information is marked with the icon.

The main menu "Menu"

Adjusting the input sensitivity – "Sensitivity"

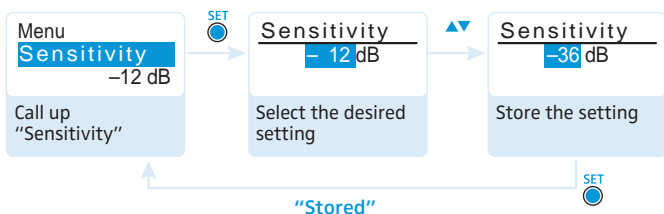

Adjustment range: 0 to -60 dB, adjustable in steps of 3 dB



The audio level display "AF" always indicates the audio level, even if the bodypack transmitter is muted, e.g. allowing you to check the adjusted sensitivity before live operation.

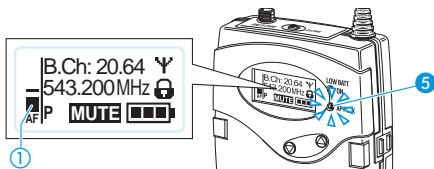

Input sensitivity is adjusted...	Effect/display
... too high	Close talking distances, speakers with loud voices or loud music passages cause overmodulation in the transmission link. The yellow AF PEAK LED ⑤ lights up. The audio level display "AF" ① shows full deflection for the duration of the overmodulation.
... correctly	The audio level display "AF" ① shows full deflection only during the loudest passages.
... too low	The transmission link is undermodulated. This results in a signal with high background noise.

The following figures are a guide to the best settings:

Transmission situation	Sensitivity setting
Loud music/vocals	-30 to -21 dB
Presentations	-21 to 0 dB
Instrument input	
Electric guitars with single coil pickups	-30 to -24 dB
Electric guitars with humbucker pickups	-45 to -30 dB
Guitars with active electronics (active pickups, active EQs, piezo pickups)	-45 to -30 dB

Selecting the frequency bank and the channel manually – "Frequency Preset"

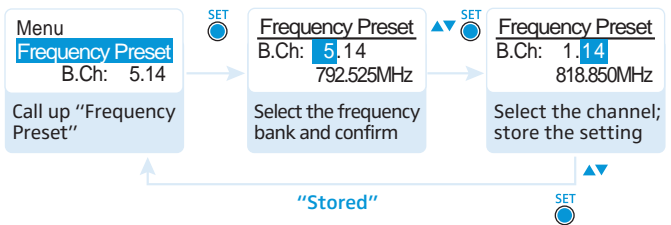

When you are in the "Frequency Preset" menu item, the RF signal is deactivated.

Overview of the frequency banks and channels:

Frequency bank	Channels	Type
"1" to "20"	up to 64 per frequency bank	System bank, frequencies are factory-preset
"U1" to "U6"	up to 64 per frequency bank	User bank, frequencies are freely selectable



When setting up multi-channel systems, please observe the following:

Only the factory-preset transmission frequencies within one frequency bank ("1" to "20") are intermodulation-free. It is vital to observe the notes on frequency selection on page 28.

Entering a name – "Name"

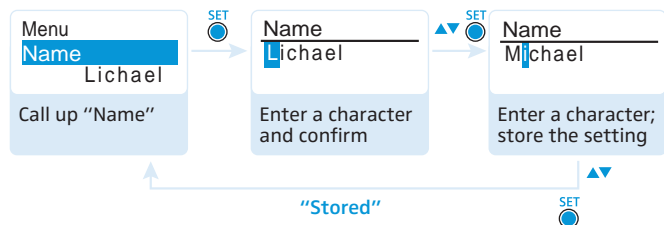

Via the "Name" menu item, you can enter a freely selectable name (e.g. the name of the performer) for the bodypack transmitter. The name can be displayed on the "Frequency/Name" and "Name/Channel" standard displays (see page 15). The name can consist of up to 8 characters such as:

- letters (without pronunciation marks),
- numbers from 0 to 9,
- special characters and spaces.

To enter a name, proceed as follows:

- ▼▲ ▶ Press the rocker button to select a character.
- SET ▶ Press the SET button to change to the next segment/character or to store the complete entry.

Activating/deactivating the automatic lock mode – “Auto Lock”

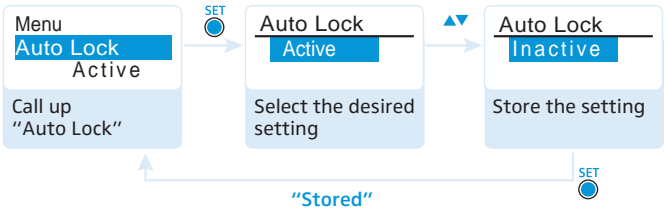

The lock mode prevents that the bodypack transmitter is accidentally switched off or programmed during operation. The lock mode icon ⑤  on the current standard display indicates that the lock mode is activated.

▼▲ ▶ Press the rocker button to select the desired setting.

For information on how to use the lock mode, refer to page 12.

The extended menu “Advanced Menu”

Setting the transmission frequencies and the frequency banks “U1” to “U6” – “Tune”



When you have selected one of the system banks and then select the “Tune” menu, the bodypack transmitter automatically switches to channel 1 of the frequency bank “U1”. In this case, “U1.1” briefly appears on the display panel.

Upon delivery, the channels of the frequency banks “U1” to “U6” are not assigned a transmission frequency.

When you are in the “Tune” menu item, the RF signal is deactivated.

Via the “Tune” menu item, you can:

1. set a transmission frequency to be stored in the current channel of the frequency bank (“U1” to “U6”)
2. or select a frequency bank (“U1” to “U6”) and a channel and assign this channel a transmission frequency.



It is vital to observe the notes on frequency selection on page 28.

Setting a transmission frequency for the current channel

- ▶ Press the rocker button until the "Tune" menu item appears.
- ▶ Press the SET button.
The frequency selection appears.

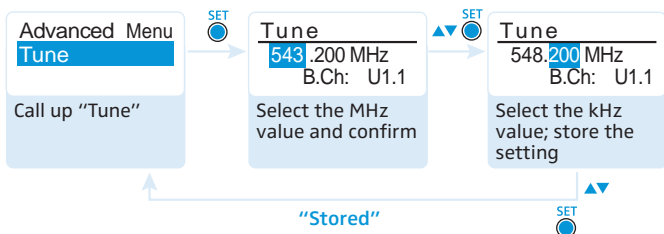

- ▶ Set the desired frequency.
- ▶ Press the SET button.
Your settings are stored. The "Tune" menu item appears.

Selecting a frequency bank and a channel and assigning this channel a transmission frequency

- ▶ Press the rocker button until the "Tune" menu item appears.
- ▶ Press the SET button and keep it pressed until the frequency bank selection appears.

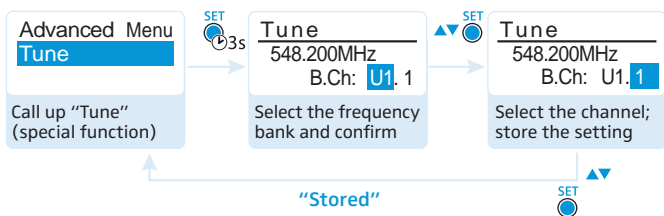

- ▶ Set the desired frequency bank.
- ▶ Set the desired channel.
- ▶ Set the desired frequency.

Setting the mode for the MUTE switch – “Mute Mode”

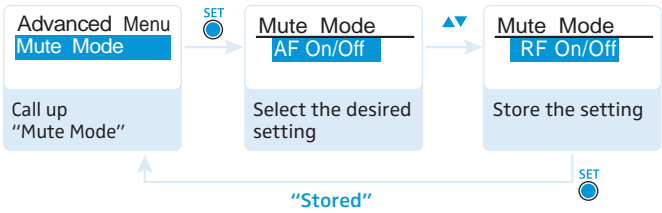

Mode	Function
“AF On/Off”	When the switch is in the MUTE position, no audio signal is transmitted.
“RF On/Off”	When the switch is in the MUTE position, the RF signal is deactivated.
“Disabled”	The muting function is deactivated.

For information on how to use the **MUTE** switch ②, refer to page 13.

Adjusting the transmission power – “RF Power”

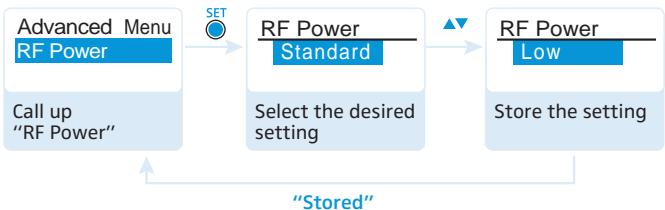

Via the “RF Power” menu item, you can adjust the transmission power in three steps (“Low”, “Standard”, “High”).



It is vital to observe the notes on the enclosed frequency information sheet!

Emulating guitar cables – “Cable Emulation”

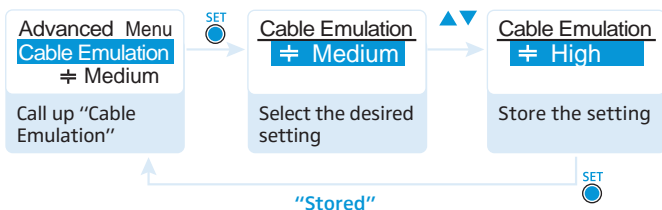

Via the “Cable Emulation” menu item, you can emulate 4 different guitar cable capacities.

Activating/deactivating the pilot tone transmission – “Pilot Tone”

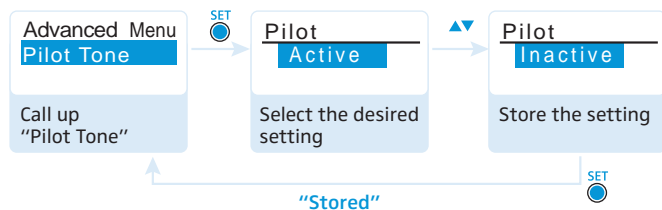

The bodypack transmitter adds an inaudible signal, known as the pilot tone, to the transmitted signal. The receiver detects and evaluates the pilot tone.

The pilot tone supports the receiver’s squelch function, thus protecting against interference due to RF signals from other devices.

Adjusting the contrast of the display panel – “LCD Contrast”

You can adjust the contrast of the display panel in 16 steps.

Resetting the settings made in the operating menu – “Reset”

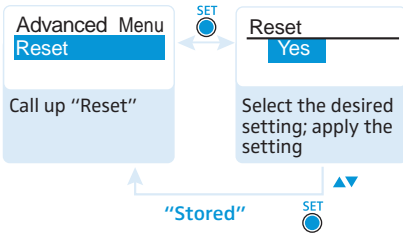

When resetting the settings made in the operating menu, only the selected settings for the pilot tone and for the frequency banks “U1” to “U6” remain unchanged. For an overview of the factory-preset default settings, refer to the enclosed frequency information sheet.

Displaying the software revision – “Software Revision”

You can display the current software revision of the bodypack transmitter.

- ▶ For information on software updates, visit the SK 2000 product page on our website at www.sennheiser.com.

Synchronizing the bodypack transmitter with a receiver

When synchronizing the bodypack transmitter with a receiver, please observe the following:



- ▶ Only use a transmitter and a receiver from the same frequency range (see the type plates on the transmitter and the receiver).
 - ▶ Make sure that the desired frequencies are listed in the enclosed frequency information sheet.
 - ▶ Make sure that the desired frequencies are approved and legal in your country and, if necessary, apply for an operating license.
-

Synchronizing the bodypack transmitter with the receiver – individual operation

Upon delivery, the bodypack transmitter and the receiver are synchronized with each other. If, however, you cannot establish a transmission link between bodypack transmitter and receiver, you have to synchronize the channels of the devices.

For information on automatic synchronization of the bodypack transmitter with the receiver (individual operation), refer to the instruction manual of the receiver. This information is marked with the  icon.

Alternatively, you can set the channel on the bodypack transmitter manually:

- ▶ Make sure that you set the bodypack transmitter to the same frequency bank and the same channel as the receiver (see page 21).

If you still cannot establish a transmission link, read the chapter "If a problem occurs ..." on page 31.

Synchronizing bodypack transmitters with receivers – multi-channel operation

Combined with 2000 series receivers, SK 2000 bodypack transmitters can form transmission links that can be used in multi-channel systems.

For information on automatic synchronization of bodypack transmitters with receivers (multi-channel operation), refer to the instruction manual of your receiver.

For more information on multi-channel operation, visit the SK 2000 product page at www.sennheiser.com.

Cleaning the bodypack transmitter

CAUTION! Liquids can damage the electronics of the bodypack transmitter!

Liquids entering the housing of the device can cause a short-circuit and damage the electronics.

- ▶ Keep all liquids away from the bodypack transmitter.
- ▶ Do not use any solvents or cleansing agents.

-
- ▶ Use a cloth to clean the bodypack transmitter from time to time.

Recommendations and tips

.. for the MKE 1, ME 102, ME 104 and ME 105 clip-on microphones

- To reduce level variations to a minimum when the user turns his or her head away from the microphone, attach the microphone as centrally as possible.
- To protect the microphone against excessive sweat/moisture, avoid direct skin contact.
- Attach the microphone carefully and conduct the cable so that noise due to friction is avoided.
- Always use the ME 104 and ME 105 directional microphones with a windshield and direct the microphones towards the sound source (e.g. mouth).

... for the HSP 2 and HSP 4 headmics

- Always use the microphone with a pop shield and position the microphone at the corner of the mouth.
- You can vary the bass reproduction by increasing/decreasing the talking distance.
- Make sure that the sound inlet is directed towards the mouth. The sound inlet is marked with a little dot.

... for the bodypack transmitter

- Make sure that the antenna and the microphone cable do not cross.
- The antenna should hang freely and be at least 1 cm away from the body. The antenna must not be in direct contact with the skin.
- For best results, make sure that the transmitter sensitivity is correctly adjusted.

... for optimum reception

- Transmission range depends to a large extent on location and can vary from about 10 m to about 150 m. There should be a "free line of sight" between transmitting and receiving antennas.
- To avoid overloading the receiver, observe a minimum distance of 5 m between transmitting and receiving antennas.

... for multi-channel operation

- For multi-channel operation, you should only use the channels within one frequency bank. Each of the frequency banks "1" to "20" accommodates factory-preset frequencies which are intermodulation-free.
- When using several transmitters simultaneously, interference can be avoided by maintaining a minimum distance of 20 cm between two transmitters.

If a problem occurs ...

Problem	Possible cause	Possible solution
Bodypack transmitter cannot be operated, "Locked" appears on the display panel	Lock mode is activated	Deactivate the lock mode (see page 12).
No operation indication	Batteries are flat or accupack is flat	Replace the batteries or recharge the accupack (see page 8).
No RF signal at the receiver	Bodypack transmitter and receiver are not on the same channel	Set the bodypack transmitter to the same channel as the receiver.
		Synchronize the bodypack transmitter with the receiver (see page 28).
	Transmission range is exceeded	Reduce the distance between bodypack transmitter and receiving antennas. Increase the transmission power (see page 25).
	RF signal is deactivated ("RF Mute")	Activate the RF signal (see page 13).

If a problem occurs ...

Problem	Possible cause	Possible solution
RF signal available, no audio signal, "MUTE" appears on the display panel	Bodypack transmitter is muted (MUTE)	Cancel the muting (see page 13).
	Receiver's squelch threshold is adjusted too high	Reduce the squelch threshold setting on the receiver.
	Bodypack transmitter doesn't transmit a pilot tone	Activate or deactivate the pilot tone transmission (see page 26).
Audio signal has a high level of background noise or is distorted	Bodypack transmitter's sensitivity is adjusted too low/too high	Adjust the input sensitivity (see page 20).

If a problem occurs that is not listed in the above table or if the problem cannot be solved with the proposed solutions, please contact your local Sennheiser partner for assistance.

To find a Sennheiser partner in your country, search at www.sennheiser.com under "Service & Support".

Accessories

The following accessories are available from your specialist dealer:

Cat. No. Product name and description

009950 BA 2015 accupack

009828 L 2015 charger

009826 CC 2 system case

Adapters

009827 DC 2 power adapter (12 V DC)

Cables

503163 CI 1-4 (3-pin special audio connector)

Microphones

502167 MKE 1-4 clip-on microphone, omni-directional, black

502168 MKE 1-4-3 clip-on microphone, omni-directional, beige

003876 ME 102-ant clip-on microphone, omni-directional, anthracite

003838 ME 102-ni clip-on microphone, omni-directional, nickel

004227 ME 104-ant clip-on microphone, cardioid, anthracite

004228 ME 104-ni clip-on microphone, cardioid, nickel

005301 ME 105-ant clip-on microphone, super-cardioid, anthracite

003402 ME 105-ni clip-on microphone, super-cardioid, nickel

009862 HSP 2 headmic, omni-directional

009864 HSP 4 headmic, cardioid

Microphone cables

004233 KA 100-4-ant copper wire cable, rt.-angled plug, anthracite

004234 KA 100-4-gr copper wire cable, rt.-angled plug, grey

004235 KA 100S-4-ant steel wire cable, straight plug, anthracite

004236 KA 100S-4-bei copper wire cable, straight plug, beige

Specifications

RF characteristics

Modulation	wideband FM
Frequency ranges	516–558, 558–626, 626–698, 718–790, 790–865 MHz (Aw to Dw, Gw, see page 4)
Transmission frequencies	up to 3,000 frequencies, tuneable in steps of 25 kHz 20 frequency banks, each with up to 64 factory-preset channels 6 frequency banks, each with up to 64 user programmable channels
Switching bandwidth	up to 75 MHz
Nominal/peak deviation	± 24 kHz/ ± 48 kHz
Frequency stability	$\leq \pm 15$ ppm
RF output power at 50 Ω	switchable: typ. 10 mW (Low) typ. 30 mW (Standard) typ. 50 mW (High)
Pilot tone squelch	can be switched off

AF characteristics

Compander system	Sennheiser HDX
AF frequency response	microphone: 80–18,000 Hz line: 25–18,000 Hz
Signal-to-noise ratio (1 mV, peak deviation)	≥ 120 dBA
THD	$\leq 0.9\%$
Max. input voltage (microphone/line)	$3 V_{\text{rms}}$
Input impedance	microphone: 40 k Ω , unbalanced line: 1 M Ω
Adjustment range of input sensitivity	60 dB, adjustable in 3-dB steps

Overall device

Temperature range	– 10°C to + 55°C
Power supply	2 AA size batteries, 1.5 V or BA 2015 accupack
Nominal voltage	2.4 V \approx
Power consumption:	
• at nominal voltage	typ. 180 mA (30 mW)
• with switched-off transmitter	$\leq 25 \mu\text{A}$
Operating time	typ. 8 hrs
Dimensions	approx. 82 mm x 64 mm x 24 mm
Weight (incl. batteries)	approx. 160 g

In compliance with

Europe:	EMC	EN 301489-1/-9
CE	Radio	EN 300422-1/-2
	Safety	EN 60065 EN 62311 (SAR)

Approved by

Canada:	Industry Canada RSS 210 IC: 2099A-SK2000 limited to 806 MHz
USA:	FCC-Part 74 FCC-ID: DMOSK2000 limited to 698 MHz

Connector assignment

3-pin special audio connector

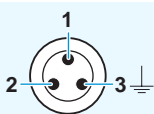

- Pin 1: AF and 5.2 V AB-powering; 8.2 k Ω internal resistance, optimized for Sennheiser pre-polarized condenser microphones
- Pin 2: +5.2 V for guitar or ground
- Pin 3 and thread: ground

Manufacturer Declarations

Warranty

Sennheiser electronic GmbH & Co. KG gives a warranty of 24 months on this product.

For the current warranty conditions, please visit our web site at www.sennheiser.com or contact your Sennheiser partner.

In compliance with the following requirements

- RoHS Directive (2002/95/EC)
- WEEE Directive (2002/96/EC)



Please dispose of the bodypack transmitter at the end of its operational lifetime by taking it to your local collection point or recycling center for such equipment.

- Battery Directive (2006/66/EC)



The supplied batteries or rechargeable batteries of the bodypack transmitter can be recycled. Please dispose of them as special waste or return them to your specialist dealer. In order to protect the environment, only dispose of exhausted batteries.

CE Declaration of Conformity

- CE0682 
- R&TTE Directive (1999/5/EC)

The declarations are available at www.sennheiser.com.

Before putting the device into operation, please observe the respective country-specific regulations.

Statements regarding FCC and Industry Canada

This device complies with Part 15 of the FCC Rules and with RSS-210 of Industry Canada. Operation is subject to the following two conditions: (1) this device may not cause harmful interference, and (2) this device must accept any interference received, including interference that may cause undesired operation.

This equipment has been tested and found to comply with the limits for a Class B digital device, pursuant to Part 15 of the FCC Rules. These limits are designed to provide reasonable protection against harmful interference in a residential installation. This equipment generates, uses and can radiate radio frequency energy and, if not installed and used in accordance with the instructions, may cause harmful interference to radio communications. However, there is no guarantee that interference will not occur in a particular installation. If this equipment does cause harmful interference to radio or television reception, which can be determined by turning the equipment off and on, the user is encouraged to try to correct the interference by one or more of the following measures:

- Reorient or relocate the receiving antenna.
- Increase the separation between the equipment and receiver.
- Connect the equipment into an outlet on a circuit different from that to which the receiver is connected.
- Consult the dealer or an experienced radio/TV technician for help.

This class B digital device complies with the Canadian ICES-003.

Changes or modifications made to this equipment not expressly approved by Sennheiser electronic Corp. may void the FCC authorization to operate this equipment.

Before putting the device into operation, please observe the respective country-specific regulations!

Index

- Accessories 33
- Accupack
 - charging 8
 - inserting 8
- Activating/deactivating
 - lock mode (Auto Lock) 23
 - pilot tone 26
- Adjusting
 - cable emulation 26
 - input sensitivity (Sensitivity) 20
 - transmission power 25
- Advanced Menu (extended menu)
 - overview 17
 - settings 23
- AF (audio level) 7
- AF PEAK (overmodulation) 7
- Audio signal, muting (Mute) 13
- Auto Lock (activating/deactivating the lock mode) 23
- Batteries, inserting 8
- Bodypack transmitter
 - attaching to clothing 10
 - cleaning 29
 - switching on/off 11
 - synchronizing with receiver 28
- Buttons (function of the ~) 16
- Cable emulation (emulating guitar cables) 26
- Channel
 - assigning a frequency 24
 - overview 4
 - selecting (Frequency Preset) 21
 - selecting (Tune) 23
- Charging
 - accupack 8
 - battery status display 7
- Cleaning (bodypack transmitter) 29
- Connecting (microphone/instrument cable) 9
- Deactivating (lock mode temporarily) 12
- Displays
 - adjusting the contrast of the display panel (LCD Contrast) 26
 - charge status 7
 - overview 7
 - standard displays 15
- Emulating guitar cables (Cable emulation) 26
- Factory default settings (resetting the settings in the operating menu) 27
- Frequency
 - preset Frequencies 4
 - ~ ranges 4
 - selecting ~ presets 21
 - setting a Transmission frequency 23
- Frequency bank
 - overview 4
 - selecting (Frequency Preset) 21
 - ~ system 4
- Frequency Preset (selecting a frequency bank/channel) 21
- Infra-red transmission 28
- Inserting (batteries/accupack) 8

- Instrument cable, connecting 9
- LCD Contrast (adjusting the contrast of the display panel) 26
- Lock mode
 - activating/deactivating (Auto Lock) 23
 - deactivating temporarily 12
- Locked (lock mode activated) 12
- Menu (main menu)
 - overview 17
 - settings 20
- Microphones
 - connecting the microphone cable 9
 - overview 4
 - pick-up patterns 4
 - suitable ~ 4
- Modulation (input sensitivity/adjusting the sensitivity) 21
- Mute (muting the audio signal) 13
- MUTE switch, function 13
- Muting (audio signal) 13
- Name (entering a name) 22
- Offline operation (RF signal deactivated) 11
- Online operation (RF signal activated) 11
- Operating menu
 - overview 16
 - using 18
- Pilot tone
 - activating/deactivating 26
 - transmission 26
- Reset (resetting the settings in the operating menu) 27
- RF Mute On/Off (activating/deactivating the RF signal) 11
- RF Power (adjusting the transmission power) 25
- RF signal
 - activating (online operation) 11
 - deactivating (during operation) 15
 - deactivating (offline operation) 11, 13
- Sensitivity (adjusting the input sensitivity) 20
- Setting up
 - multi-channel system 28
 - transmission link 28
- Software Revision (displaying the software revision) 27
- Switching on/off
 - bodypack transmitter 11
- Synchronizing (bodypack transmitter/receiver) 28
- Transmission frequency
 - selecting (Frequency Preset) 21, 23
 - setting (Tune) 23
- Transmission power, optimizing 30
- Troubleshooting 31

Tune (setting the transmission frequencies and frequency banks) 23

Unlock (deactivating the lock mode) 12

Using

bodypack transmitter 11

operating menu 16

Sennheiser electronic GmbH & Co. KG
Am Labor 1, 30900 Wedemark, Germany
www.sennheiser.com

Printed in Germany
Publ. 01/09
529677/A01

Free Manuals Download Website

<http://myh66.com>

<http://usermanuals.us>

<http://www.somanuals.com>

<http://www.4manuals.cc>

<http://www.manual-lib.com>

<http://www.404manual.com>

<http://www.luxmanual.com>

<http://aubethermostatmanual.com>

Golf course search by state

<http://golfingnear.com>

Email search by domain

<http://emailbydomain.com>

Auto manuals search

<http://auto.somanuals.com>

TV manuals search

<http://tv.somanuals.com>