

SK 5212-II



Instruction manual

 **SENNHEISER**

Contents

Important safety instructions	2
The SK 5212-II bodypack transmitter	3
Delivery includes	5
Product overview	6
Overview of the SK 5212-II bodypack transmitter	6
Overview of the displays	7
Putting the bodypack transmitter into operation	8
Inserting and changing the battery	8
Connecting the microphone	8
Connecting the antenna	9
Attaching the transmitter to clothing	9
Using the bodypack transmitter	10
Switching the transmitter on/off	10
Doing a frequency check	11
The automatic lock mode (autolock function)	11
Using operating menu	13
The buttons	13
Overview of the operating menu	14
Working with the operating menu	15
Overview of the menus	18
Adjustment tips for the operating menu	20
Selecting a channel – “CHAN”	20
Selecting the frequencies to be stored in the frequency bank “VAR” – “TUNE”	20
Entering a name – “NAME”	22
Adjusting the microphone sensitivity – “ATTEN”	22
Adjusting the bass roll-off frequency – “LOWCUT”	23
Selecting the standard display – “VIEW”	23
Loading the factory-preset default settings – “RESET”	23
Activating/deactivating the automatic lock mode – “LOCK”	24
Adjusting the output power – “POWER”	24
Displaying the software revision – “SW--REV”	24
Exiting the operating menu – “EXIT”	25
Cleaning the bodypack transmitter	25
Recommendations and tips	25
If a problem occurs	26
Accessories	27
Specifications	28
Manufacturer Declarations	31

Important safety instructions

- Read this instruction manual.
- Keep this instruction manual. Always include this instruction manual when passing the product on to third parties.
- Heed all warnings and follow all instructions in this instruction manual.
- Use only a cloth for cleaning the product.
- Do not place the product near any heat sources such as radiators, stoves, or other devices (including amplifiers) that produce heat.
- Only use attachments/accessories specified by Sennheiser.
- Refer all servicing to qualified service personnel.
Servicing is required if the product has been damaged in any way, liquid has been spilled, objects have fallen inside, the product has been exposed to rain or moisture, does not operate properly or has been dropped.
- **WARNING:** This product should be protected against the ingress of liquids (eg: water, sweat, etc.) as this can cause malfunctions due to shortages or corrosion, etc. 

Intended use

Intended use of the product includes:

- having read this instruction manual especially the chapter “Important safety instructions”,
- using the product within the operating conditions and limitations described in this instruction manual.

“Improper use” means using the product other than as described in this instruction manual, or under operating conditions which differ from those described herein.

The SK 5212-II bodypack transmitter

The SK 5212-II is a professional bodypack transmitter that is easy to use and is easily adaptable to a wide variety of applications.

The SK 5212-II bodypack transmitter has the following features:

- Extremely compact diecast metal housing
- Very rugged casing
- Special protection against the ingress of moisture
- Backlit LC display
- Menu-assisted operation
- Specially suitable for multi-channel applications
- Up to 184 MHz switching bandwidth
- Transmission frequencies tuneable in steps of 5 kHz
- Adjustable output power:
10 mW, 10 mW Low Intermodulation mode (Lol), 50 mW.
In Low Intermodulation mode (Lol), the intermodulation performance is significantly improved
- Constant output power until the battery is completely discharged
- Audio sensitivity adjustable in steps of 1 dB, sensitivity range of 70 dB
- Signal-to-noise ratio typ. 110 dB(A)
- Switchable low-cut filter
- Battery status display, battery status also transmitted to the receiver
- Reliable, easy-to-use clip attachment

Information on the compander system

This product is equipped with HiDynplus™, the Sennheiser noise reduction system that reduces RF interference. HiDynplus™ offers extreme operational reliability and ensures highest transmission quality.

The frequency bank system

The transmitter is available in five UHF frequency ranges with up to 184 MHz switching bandwidth:

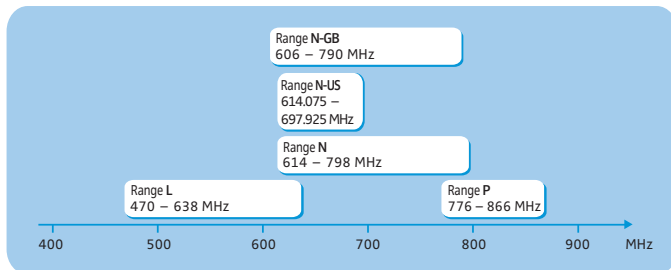

The transmitter has two frequency banks:

Channel	Frequency bank	
	“FIX”	“VAR”
1	The transmission frequencies are factory- preset (see enclosed frequency table) and cannot be changed.	The transmission frequencies can be freely selected within the switching bandwidth.
2		
...		
max. 59		
	<p>Optimized for maximum transmission reliability</p> <p>Additionally available channels in Low Intermodulation mode</p>	



The factory-preset frequencies within the frequency bank “FIX” are interference and intermodulation-free.

- ▶ Set all transmitters of your multi-channel system to different channels within the frequency bank “FIX”.

Suitable receivers

- EM 1046 system
- EM 3532, EM 3031, EM 3032
- EK 3041, EK 3241
- EM 3731, EM 3732, EM 3732 COM
- EM 3731-II, EM 3732-II, EM 3732 COM-II

Delivery includes

Delivery of the bodypack transmitter includes:

1 SK 5212-II bodypack transmitter

1 AA size battery, 1.5 V

antennas for different frequency ranges

1 belt clip

1 instruction manual

1 frequency table

1 supplement "Legal requirements for the use of radiomicrophones"

Product overview

Overview of the SK 5212-II bodypack transmitter

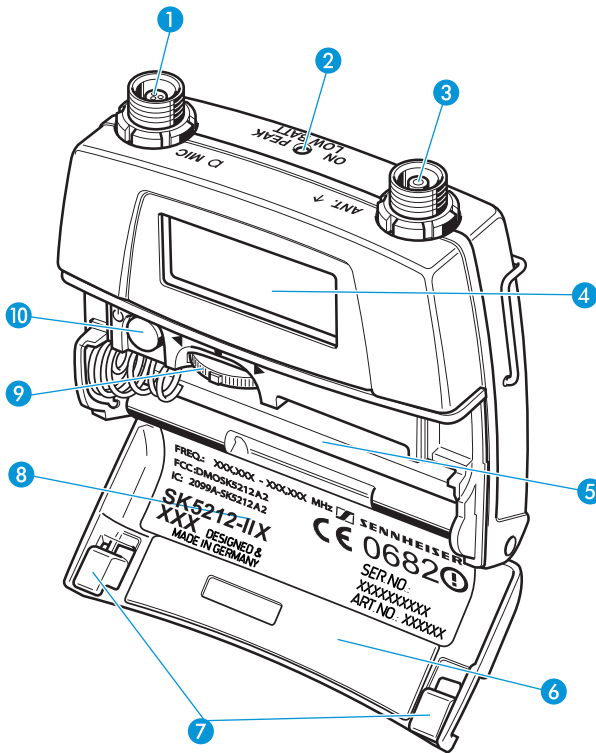

- 1 Microphone input
- 2 Red LED for operation and battery status indication (ON/LOW BATT/PEAK)
- 3 Antenna socket
- 4 LC display, backlit
- 5 Battery compartment
- 6 Battery compartment cover
- 7 Battery compartment catches
- 8 Type plate
- 9 Multi-function switch with three switch positions:
▼ (DOWN), ▲ (UP) and SET
- 10 ON/OFF button with ESC function (cancel)

Overview of the displays

Display backlighting

When the lock mode is deactivated, the LC display remains backlit for approx. 20 seconds after pressing a button.

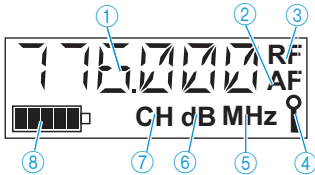

- ① Alphanumeric display
- ② Level display for audio signal "AF"
- ③ "RF" – appears when an RF signal is transmitted
- ④ Lock mode icon (lock mode is activated)
- ⑤ "MHz" – appears when the transmission frequency is displayed
- ⑥ "dB" – appears when the microphone sensitivity is displayed
- ⑦ "CH" – appears when the channel number is displayed
- ⑧ Battery status display

Operation and battery status indication

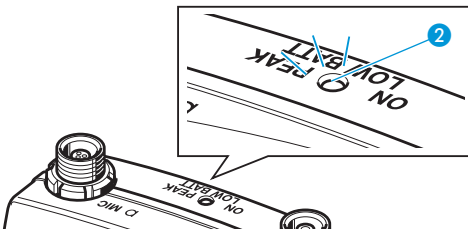

Red LED ② ...	Meaning
... lights up normally	The transmitter is switched on and the capacity of the battery is sufficient (ON).
... is flashing	The battery is going flat (LOW BATT)!
... lights up brightly	The transmitter is fully modulated (PEAK).

Putting the bodypack transmitter into operation

Inserting and changing the battery

For powering the transmitter, use a 1.5 V AA size battery.

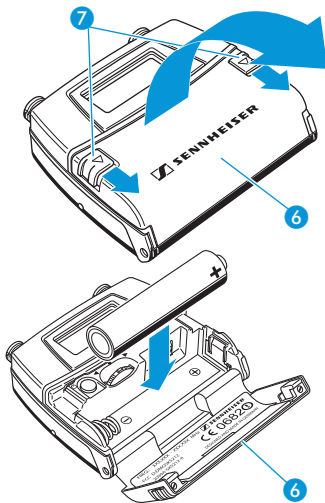

- ▶ Open the battery compartment by pushing the two catches **7** in the direction of the arrows and open the cover **6**.
- ▶ Insert the battery as shown in the diagram on the left. Please observe correct polarity when inserting the battery.
- ▶ Close the battery compartment.

Connecting the microphone

The transmitter is designed for use with Sennheiser lavalier microphones and headmics. The power supply of these microphones is via the microphone input **1** of the transmitter.

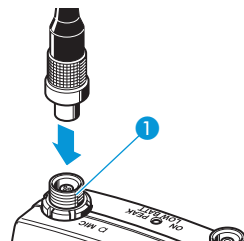

- ▶ Connect the microphone to the microphone input **1** of the transmitter.
- ▶ Screw down the coupling ring.

Connecting the antenna

The transmitter is supplied with plug-on antennas: Choose the antenna that matches the frequency range used.

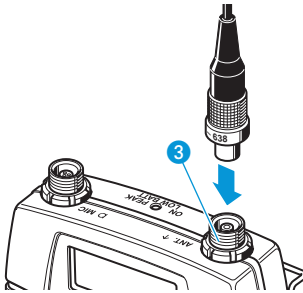

- ▶ Connect the antenna to the antenna socket 3 of the transmitter.
- ▶ Screw down the coupling ring.



Only use antennas that match the frequency range of the transmitter.

The frequency range is printed on the antenna.

Attaching the transmitter to clothing

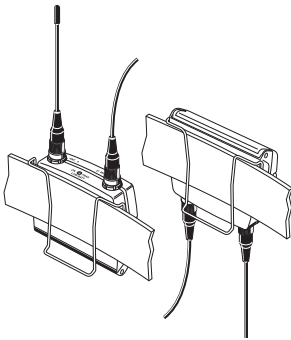

The transmitter is attached to clothing (e.g. belt, waistband) with the supplied belt clip.

The clip is detachable so that you can also attach the transmitter with the antenna pointing downwards. To do so, withdraw the clip from its fixing points and attach it the other way round.

Using the bodypack transmitter

Switching the transmitter on/off

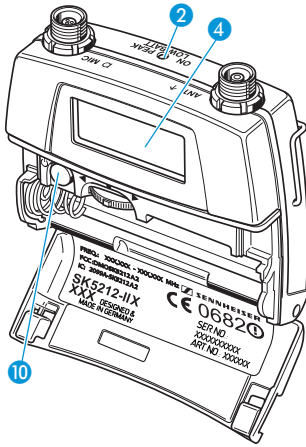

- ▶ Open the battery compartment.

To switch the transmitter on:

- ▶ Briefly press the ON/OFF button 10. The red LED 2 lights up normally and the standard display is shown on the LC display panel 4; after a short pause, "RF" appears on the LC display panel.



Remove the battery when the transmitter will not be used for extended periods of time.

The transmitter can only be switched off when the lock mode is deactivated (see page 11).



- ▶ To switch the transmitter off, press the ON/OFF button 10 until "OFF" appears on the LC display panel 4. The red LED 2 and the LC display panel go off.



When in the setting mode of the operating menu, the ON/OFF button 10 will cancel your entry (ESC function).

Doing a frequency check

The transmitter has a frequency check mode that prevents the transmitter transmitting on an unwanted frequency after switch-on.

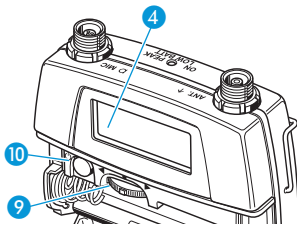

- ▶ When switching on the transmitter, keep the **ON/OFF** button **10** pressed. The RF signal is deactivated. The current frequency is displayed on the LC display panel **4**.

If the displayed frequency is the correct one,

- ▶ Release the **ON/OFF** button **10**. After five seconds, “**RF**” **3** appears on the LC display panel and the RF signal is activated.



To change the transmission frequency, proceed as follows:

- ▶ Release the **ON/OFF** button **10**.
- ▶ Within five seconds change to the “**CHAN**” or “**TUNE**” menu item.
- ▶ Change the transmission frequency (see “Adjustment tips for the operating menu” on page 20).

The automatic lock mode (autolock function)

The transmitter has an autolock function (automatic lock mode) that can be activated or deactivated via the “**LOCK**” menu (see page 24). When the autolock function is activated, the lock mode is automatically activated 10 seconds after pressing the last button.

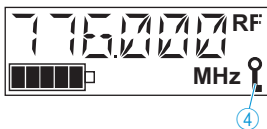

Prior to this, the lock mode icon **4** flashes several times on the LC display panel **4**, indicating that the lock mode is being activated.



The autolock function can be deactivated permanently (see page 24) or temporarily (see page 12).

Deactivating the autolock function temporarily

To make changes to the settings via the operating menu, you can temporarily deactivate the lock mode.

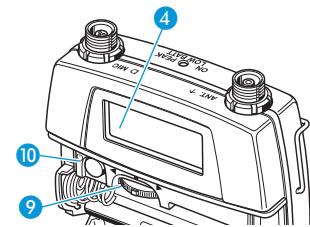

- ▶ Press the **ON/OFF** button **10** or the multi-function switch **9** (switch position **•SET**).
"LOCK" appears on the LC display panel **4**.
- ▶ Slide the multi-function switch **9** to the position **▲** (UP) or **▼** (DOWN).
"UNLOCK" appears on the LC display panel **4**.
- ▶ Press the multi-function switch **9** (switch position **•SET**).
You can now change the settings.



After you have exited the operating menu, the lock mode is automatically activated after 10 seconds. You can activate the lock mode immediately by briefly pressing the **ON/OFF** button **10**.

Using operating menu

The buttons

Button	Mode	Function of the button
ON/OFF	Switched off	<ul style="list-style-type: none"> Briefly pressing the button: Switches the transmitter on Keeping the button pressed: Does a frequency check
	Display mode	<ul style="list-style-type: none"> Briefly pressing the button (with activated autolock function): Immediately activates the lock mode Briefly pressing the button (with activated lock mode): Calls up the lock mode for deactivation Pressing the button for 3 sec. (with deactivated lock mode): Switches the transmitter off
	Selection mode	Cancels the entry and returns to the display mode
	Setting mode	Cancels the entry and returns with the last setting stored to the last parameter displayed in the display mode
•SET	Display mode	<ul style="list-style-type: none"> With deactivated lock mode: Changes to the selection mode With activated lock mode: Calls up the lock mode for deactivation
	Selection mode	Changes to the setting mode of the selected menu
	Setting mode	Stores the setting and returns to the selection mode ("STORED" is displayed)
▲ (UP)/ ▼ (DOWN)	Display mode	Changes to the previous parameter (▲) or changes to the next parameter (▼)
	Selection mode	Changes to the previous menu (▲) or changes to the next menu (▼)
	Setting mode	Increases (▲) or reduces (▼) the setting of the selected menu

Overview of the operating menu

Menu	Function of the menu
"CHAN"	Selects a channel
"TUNE"	Sets transmission frequencies for the frequency bank "VAR" (variable bank)
"NAME"	Enters a name
"ATTEN"	Adjusts the microphone sensitivity
"LOWCUT"	Adjusts the bass roll-off frequency
"VIEW"	Selects the standard display
"RESET"	Loads the factory-preset default settings
"LOCK"	Activates/deactivates the autolock function
"POWER"	Adjusts the output power
"SW--REV"	Displays the current software revision
"EXIT"	Exits the operating menu and returns to the standard display

Working with the operating menu

The operating menu has three modes:

- **Display mode:**
In display mode, you can display the current menu settings one after the other – even when the lock mode is activated.
- **Selection mode:**
In selection mode, you can select the menu whose setting you want to change. To change to the selection mode, the lock mode must be deactivated.
- **Setting mode:**
In setting mode, you can change the setting of the selected menu.

By way of example of the “LOWCUT” menu, this section describes how to use the operating menu.

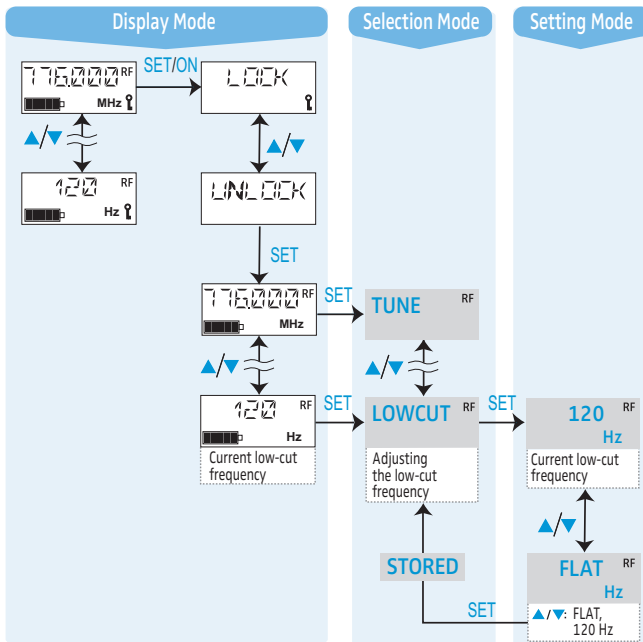

After switch-on

After switch-on, the standard display is shown on the LC display panel. Depending on the setting, the transmission frequency, the channel number or the name of the transmitter is displayed.

Displaying the menu settings in display mode

In display mode, and with the lock mode activated, you can display the current menu settings one after the other (see "Overview of the menus" on page 18). After a few seconds, the display returns to the standard display.



- ▶ Slide the multi-function switch 9 to the position ▲ (UP) or ▼ (DOWN) to display the menu settings. If you slide the multi-function switch repeatedly to the same position, all menu settings are displayed one after the other.

Changing to the selection mode

To change from display mode to selection mode, you have to deactivate the lock mode.

- ▶ Deactivate the lock mode as described in the chapter "Deactivating the autolock function temporarily" on page 12. You can now select the menu whose settings you want to adjust.
- ▶ Press the multi-function switch 9 (switch position •SET). You change to the menu that was displayed in display mode.

Selecting a menu



- ▶ Slide the multi-function switch 9 to the position ▲ (UP) or ▼ (DOWN).
- ▶ Press the multi-function switch 9 (switch position •SET). The name of the selected menu starts flashing.

Changing to the setting mode of a selected menu



- ▶ Press the multi-function switch 9 (switch position •SET). You change to the setting mode of the selected menu where you can adjust settings. The current setting that can be adjusted flashes on the LC display panel 4.

Adjusting a setting

Use the multi-function switch 9 to adjust the setting of the selected menu.

By briefly sliding the multi-function switch 9 to the position ▲ (UP) or ▼ (DOWN), the display jumps either forwards or backwards to the next setting.

In the "ATTEN", "CHAN", "TUNE" and "NAME" menu and when slid to the position ▲ (UP) or ▼ (DOWN), the multi-function switch 9 features a "fast search" function, i.e. the display cycles continuously. In the "TUNE" menu, the cycling of the display is continuously accelerated. The "fast search" function allows you to get fast and easily to your desired setting.

Storing a setting



- ▶ Press the multi-function switch 9 (switch position ●SET) to permanently store a setting. "STORED" appears on the display panel, indicating that the setting has been stored. The display then returns to the last edited menu.

With most menus, new settings become effective immediately without having to be stored. An exception are the "TUNE" and "CHAN" menus. With these menus, new settings only become effective after they have been stored ("STORED" appears on the LC display panel 4, indicating that the setting has been stored).

Exiting the operating menu

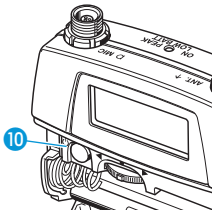

- ▶ Select the "EXIT" menu to exit the operating menu and to return to the standard display. When in the operating menu, pressing the ON/OFF button 10 will cancel your entry (ESC function) and return you to the standard display with the last stored settings.

Overview of the menus

Deactivate the lock mode before adjusting the settings (see "Deactivating the autolock function temporarily" on page 12). Pressing the **ON/OFF** button **10** will cancel your entry (ESC function) and return you to the display mode.

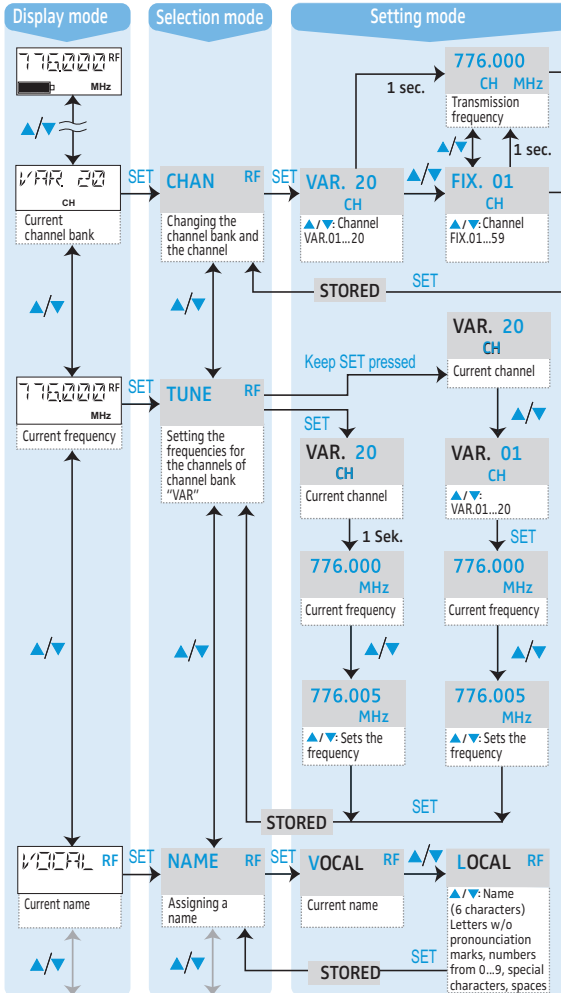

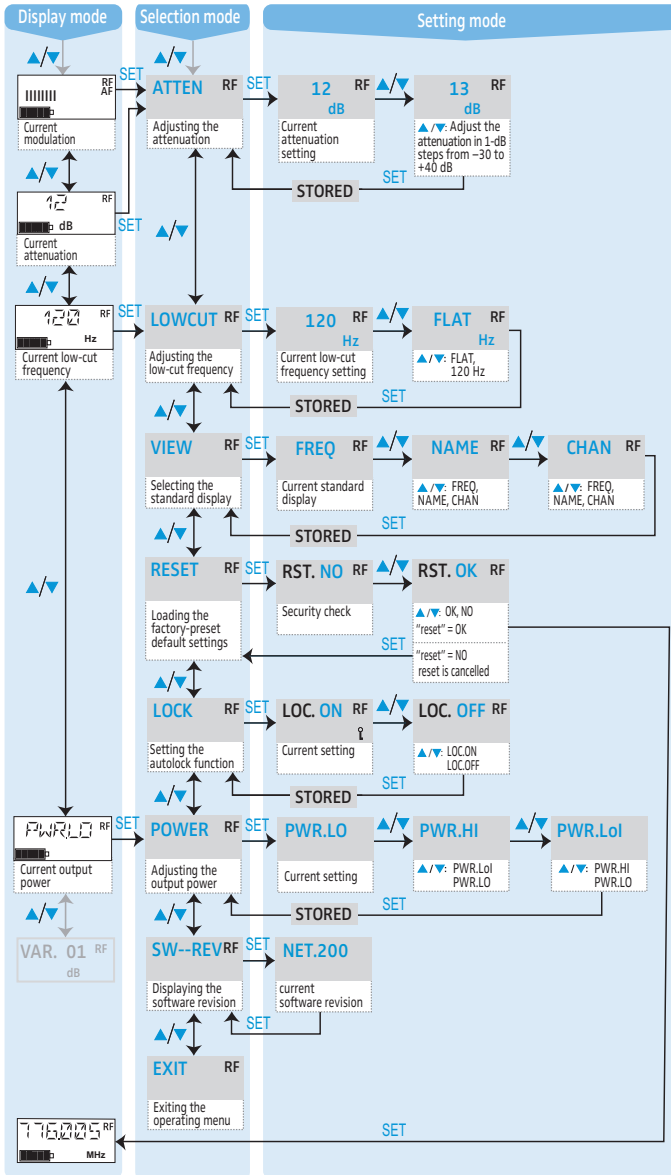

Adjustment tips for the operating menu



When setting frequencies on the bodypack transmitter, please observe the following:

- ▶ Make sure that the desired frequencies are listed in the enclosed frequency table and approved and legal in your country. If necessary, apply for an operating license. For an overview of the frequencies and transmission powers, refer to the enclosed supplement "Legal requirements for the use of radiomicrophones".

Selecting a channel – "CHAN"

Via the "CHAN" menu, you can switch between the channels in the frequency banks "FIX" and "VAR". The RF signal is deactivated while this adjustment is being made.

When changing to the setting mode of the "CHAN" menu, the current channel number appears on the LC display panel. After approx. 1 second, the currently assigned transmission frequency is displayed:

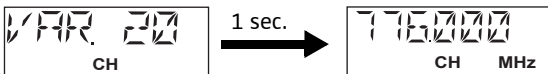

- ▶ To select a different channel, slide the multi-function switch 9 to the position ▲ (UP) or ▼ (DOWN). The new channel number appears on the LC display panel for approx. 1 second and then the currently assigned transmission frequency is displayed. Only after the new setting has been stored ("STORED" has appeared on the LC display panel) is the RF signal with the frequency of the selected channel activated.

Selecting the frequencies to be stored in the frequency bank

"VAR" – "TUNE"

Via the "TUNE" menu, you can freely select the frequencies to be stored in the frequency bank "VAR" (variable bank). The RF signal is deactivated while this adjustment is being made.



When you have selected the frequency bank "FIX" and then select the "TUNE" menu, the transmitter automatically switches to channel 01 of the frequency bank "VAR" and the text "VAR" briefly appears on the LC display panel 4.

The frequencies are tuneable in 5-kHz steps within a switching bandwidth of 184 MHz max.



When operating a multi-channel system, make sure to only use intermodulation-free frequencies.

There are two options for setting the frequencies:

- You can set a new frequency for the selected channel:



- In the selection mode of the "TUNE" menu, press the multi-function switch 9 (switch position •SET). The current channel number appears on the LC display panel and then the currently assigned frequency is displayed.

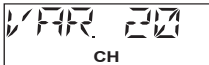

- Change the frequency by sliding the multi-function switch 9 to the position ▲ (UP) or ▼ (DOWN).



- Store your setting.



- You can change to a different channel and set a new frequency for the new channel:



- Press the multi-function switch 9 (switch position •SET) for a longer time. The current channel flashes on the LC display panel.

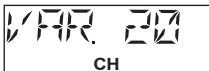

- Select a new channel by sliding the multi-function switch ▲ (UP) or ▼ (DOWN).

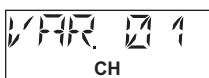

- Confirm your selection by pressing the multi-function switch (switch position •SET).



- The current frequency of the selected channel is displayed. Change the frequency by sliding the multi-function switch 9 to the position ▲ (UP) or ▼ (DOWN).

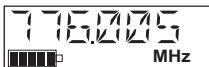

- Store your setting.

Entering a name – “NAME”

Via the “NAME” menu, you can enter a freely selectable name for the transmitter. This name can be displayed on the standard display and can consist of up to six characters such as:

- letters (without pronunciation marks),
- numbers from 0 to 9,
- special characters and spaces.

After you have changed to the setting mode of the “NAME” menu, the first segment starts flashing on the LC display panel 4.



- ▶ Slide the multi-function switch 9 to the position ▲ (UP) or ▼ (DOWN) to select a character.
(By sliding the switch only once, the display jumps either forwards or backwards to the next character. If you keep the switch slid, the display starts cycling continuously.)
- ▶ Press the multi-function switch 9 (switch position •SET) to change to the next segment.
- ▶ Have you entered the name completely? Press the multi-function switch 9 (switch position •SET) to store your setting. “STORED” appears on the LC display panel.

Adjusting the microphone sensitivity – “ATTEN”

Via the “ATTEN” menu, you can adjust the transmitter’s sensitivity.

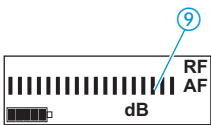

The sensitivity is correctly adjusted when the level display for audio signal “AF” 9 shows full deflection only during the loudest passages or when the red LED 2 lights up brightly.

The sensitivity can be adjusted in 1-dB steps from +40 dB to –30 dB.

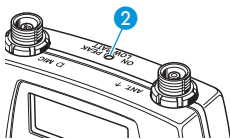

The bargraph has a resolution of approx. 3 dB per segment with a display range of 45 dB.

Adjusting the bass roll-off frequency – “LOWCUT”

To reduce unwanted low-frequency noise such as wind and handling noise, you can activate a low-cut filter. The low-cut frequency is 120 Hz.

If you do not want to reduce low-frequency signal portions, select the setting “FLAT”.

Selecting the standard display – “VIEW”

Via the “VIEW” menu, you can select one of the following standard displays:

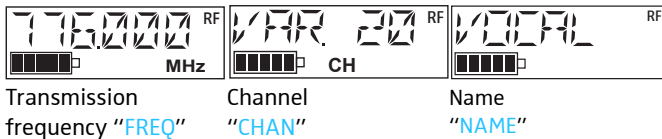

The selected standard display is shown

- after switch-on,
- after the menu settings have been displayed for 10 seconds in display mode.

Loading the factory-preset default settings – “RESET”

Via the “RESET” menu, you can load the factory-preset default settings. After the reset, the standard display is shown on the LC display panel.

Function	Setting
Low-cut frequency	“FLAT”
Microphone sensitivity	“0 dB”
Name	“SK5212”
Standard display	Transmission frequency
Autolock function	deactivated
Channel	“FIX 01”
Output power	“PWR.HI”
Frequencies in the frequency bank “VAR” are reset.	

Activating/deactivating the automatic lock mode – “LOCK”

The transmitter has an autolock function (automatic lock mode) that can be activated or deactivated via the “LOCK” menu. When the autolock function is activated, the lock mode is automatically activated 10 seconds after pressing the last button. The lock mode protects the transmitter from accidental programming.



- ▶ In the selection mode of the “LOCK” menu, press the multi-function switch 9 (switch position •SET). The current setting of the autolock function is displayed.
- ▶ Change the setting by sliding the multi-function switch 9 to the position ▲ (UP) or ▼ (DOWN). Select “LOC.ON” to activate the autolock function or select “LOC.OFF” to deactivate the autolock function.
- ▶ Store your setting by pressing the multi-function switch 9 (switch position •SET).



Adjusting the output power – “POWER”

The transmitter features switchable output power. With reduced output power, the operating time increases.

In addition, you can also adjust the transmitter to “Low Intermodulation mode” (“Lol”). By so doing, the transmitter’s intermodulation performance is significantly improved, especially in multi-channel operation. In “Low Intermodulation mode”, the output power is reduced to 10 mW; the operating time will be about the same as using an output power of 50 mW.

Displaying the software revision – “SW--REV”

You can display the current software revision of the bodypack transmitter by calling up the “SW-REV” menu item.

Exiting the operating menu – “EXIT”

Via the “EXIT” menu, you can exit the operating menu and return to the standard display.

When in the operating menu, briefly pressing the ON/OFF button **10** will cancel your entry (ESC function) and return you to the standard display without saving any changes.

Cleaning the bodypack transmitter

CAUTION Liquids can damage the electronics of the bodypack transmitter!

Liquids entering the housing of the device can cause a short-circuit and damage the electronics.

▶ Keep all liquids away from the bodypack transmitter.

- ▶ Use a cloth to clean the bodypack transmitter from time to time.
- ▶ Do not use any solvents or cleansing agents.

Recommendations and tips

Tips for optimum reception

- Transmission range depends to a large extent on location and on the selected output power. There should be a “free line of sight” between transmitting and receiving antennas.
- To avoid overloading the receiver, observe a minimum distance of 5 m between transmitting and receiving antennas.

Tips for multi-channel operation

- When operating a multi-channel system, make sure to only use intermodulation-free frequencies.

If a problem occurs ...

Problem	Possible cause	Possible solution
No operation indication	Battery is flat or inserted incorrectly	Replace the battery or check if it is inserted correctly
Transmitter cannot be switched off/ Settings cannot be changed	Lock mode is activated	Deactivate the lock mode (see page 12)
Receiver: No RF signal	Transmitter and receiver are not on the same channel	Set transmitter and receiver to the same channel
	Transmitter is out of range	Check the squelch threshold setting on the receiver or reduce the distance between receiving antenna and transmitter
Audio signal has a high level of background noise	Transmitter's sensitivity is set too high	See "Adjusting the microphone sensitivity – "ATTEN"" on page 22
	Receiver's output level is set too low	Increase the line output level
Audio signal is distorted	Transmitter's sensitivity is set too low	See "Adjusting the microphone sensitivity – "ATTEN"" on page 22
	Receiver's output level is set too high	Reduce the line output level

If a problem occurs that is not listed in the above table or if the problem cannot be solved with the proposed solutions, please contact your local Sennheiser partner for assistance.

To find a Sennheiser partner in your country, search at www.sennheiser.com under "Service & Support".

Accessories

.....	MKE 1 clip-on microphone, omni-directional, available in different versions
.....	MKE 2 Gold clip-on microphone, omni-directional, available in different versions
.....	MKE Platinum clip-on microphone, omni-directional, available in different versions
003876	ME 102-ant clip-on microphone, omni-directional, anthracite
003838	ME 102-ni clip-on microphone, omni-directional, nickel
004227	ME 104-ant clip-on microphone, cardioid, anthracite
004228	ME 104-ni clip-on microphone, cardioid, nickel
005301	ME 105-ant clip-on microphone, super-cardioid, anthracite
003402	ME 105-ni clip-on microphone, super-cardioid, nickel
009862	HSP 2 headmic, omni-directional
009864	HSP 4 headmic, cardioid

Specifications

Modulation	wideband FM
Frequency ranges	range L: 470 to 638 MHz range N: 614 to 798 MHz range N-US: 614.075 to 697.925 MHz range N-GB: 606 to 790 MHz range P: 776 to 866 MHz
Switching bandwidth	up to 184 MHz
Transmission frequencies	frequency bank "FIX" with up to 59 factory-preset frequencies frequency bank "VAR" with 20 freely selectable frequencies (frequencies tuneable in steps of 5 kHz)
RF output power	switchable, typ.: 50 mW (PWR.HI) 10 mW (PWR.LO) 10 mW (PWR.Lol)
Frequency stability	± 10 ppm in the specified temperature range
Nominal/peak deviation	± 40 kHz/ ± 56 kHz
Signal-to-noise ratio	typ. 110 dB(A) _{rms}
THD (at 1 kHz, nominal deviation)	< 0.3%
AF frequency response	60 to 20,000 Hz
Noise reduction system	Sennheiser HiDynplus™
Input sensitivity at nominal deviation	-40 dBu = 7.75 mV
Low-cut frequency (-3 dB)	adjustable (flat, 120 Hz)
Sensitivity	adjustable in steps of 1 dB from -30 to +40 dB

Power consumption (without LC display illumination)	PWR.LO: approx. 150 mA (10 mW) at 1.5 V PWR.HI: approx. 220 mA (50 mW) at 1.5 V PWR.Lol: approx. 220 mA (10 mW) at 1.5 V
--	--

Operating time	PWR.LO: approx. 10 hrs PWR.HI: approx. 5.5 hrs PWR.Lol: approx. 5.5 hrs
----------------	---

Connections	AF: 3-pin special audio socket RF: coax socket
-------------	---

Dimensions	approx. 53 x 60 x 17 mm
------------	-------------------------

Weight	approx. 124 g incl. battery and antenna
--------	---

Operating conditions

Ambient temperature	-10°C to +55°C
---------------------	----------------

Relative humidity	max. 90% (non condensing)
-------------------	---------------------------

Power supply	1 AA size battery, 1.5 V
--------------	--------------------------

Storage and transport conditions

Ambient temperature	-25°C to +70°C
---------------------	----------------

Relative humidity	max. 90%
-------------------	----------

Shock test	shock test according to IEC 68 or EN 60068, T2-27
------------	---

In compliance with

Europe:	EMC	EN 301489-1/-9
	Radio	EN 300422-1/-2
	Safety	EN 60065 EN 62311 (SAR)

Approved by

Canada

Industry Canada RSS-123

IC: 2099A-SK5212A2

limited to 698 MHz

USA

FCC-Part 74

FCC ID: DMOSK5212A2

limited to 698 MHz

Pin assignment of microphone socket

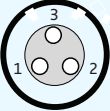
AF socket	
	Pin 1: +5.2 V for external special microphones
	Pin 2: AF and 5.2 V AB-powering; 8.2 kΩ internal resistance, optimized for Sennheiser pre-polarized condenser microphones.
	Pin 3 and thread: ground

Audio sensitivity

The transmitter's audio sensitivity can be adjusted over a range of 70 dB (+40 dB to -30 dB) in steps of 1 dB. The diagram below shows the sensitivity range of the SK 5212-II in comparison to the earlier product generations SK 50 and SK 5012.

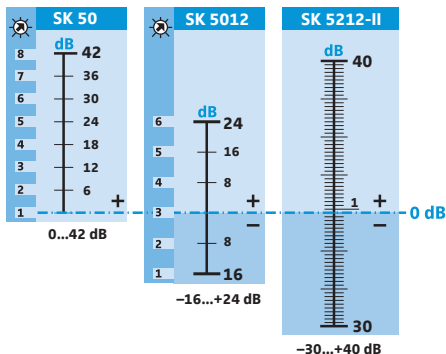

 Switch position

Manufacturer Declarations

Warranty

Sennheiser electronic GmbH & Co. KG gives a warranty of 24 months on this product.

For the current warranty conditions, please visit our website at www.sennheiser.com or contact your Sennheiser partner.

In compliance with

- RoHS Directive (2002/95/EC)
- Battery Directive (2006/66/EC)

The supplied batteries or rechargeable batteries can be recycled. Please dispose of them as special waste or return them to your specialist dealer. In order to protect the environment, only dispose of exhausted batteries.



CE Declaration of Conformity

- **CE 0682** 
- R&TTE Directive (1999/5/EC)

The declarations are available at www.sennheiser.com. Before putting the device into operation, please observe the respective country-specific regulations.

Statements regarding FCC and Industry Canada

This device complies with Part 15 of the FCC Rules and with RSS-123 of Industry Canada. Operation is subject to the following two conditions: (1) this device may not cause harmful interference, and (2) this device must accept any interference received, including interference that may cause undesired operation.

This equipment has been tested and found to comply with the limits for a Class B digital device, pursuant to Part 15 of the FCC Rules. These limits are designed to provide reasonable protection against harmful interference in a residential installation. This equipment generates, uses and can radiate radio frequency energy and, if not installed and used in accordance with the instructions, may cause harmful interference to radio communications. However, there is no guarantee that interference will not occur in a particular installation. If this equipment does cause harmful interference to radio or television reception, which can be determined by turning the equipment off and on, the user is encouraged to try to correct the interference by one or more of the following measures:

- Reorient or relocate the receiving antenna.
- Increase the separation between the equipment and receiver.
- Connect the equipment into an outlet on a circuit different from that to which the receiver is connected.
- Consult the dealer or an experienced radio/TV technician for help.

This class B digital device complies with the Canadian ICES-003.

Changes or modifications made to this equipment not expressly approved by Sennheiser electronic Corp. may void the FCC authorization to operate this equipment.

Before putting the device into operation, please observe the respective country-specific regulations!

Sennheiser electronic GmbH & Co. KG

Am Labor 1, 30900 Wedemark, Germany
www.sennheiser.com

Printed in Germany, Publ. 11/10, 542646/A01



Free Manuals Download Website

<http://myh66.com>

<http://usermanuals.us>

<http://www.somanuals.com>

<http://www.4manuals.cc>

<http://www.manual-lib.com>

<http://www.404manual.com>

<http://www.luxmanual.com>

<http://aubethermostatmanual.com>

Golf course search by state

<http://golfingnear.com>

Email search by domain

<http://emailbydomain.com>

Auto manuals search

<http://auto.somanuals.com>

TV manuals search

<http://tv.somanuals.com>