

WASHER DRYER >

User Manual

Model Numbers:

WD1496FGW

WD1496FGS

WD1496FGB

WD1496FGR

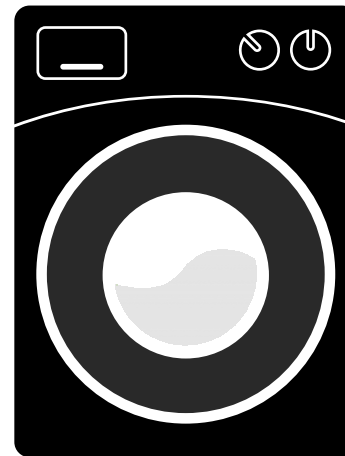

SERVIS
EFFICIENCY BY DESIGN

Visit
servis.co.uk



Contents ›

01	Welcome
02	Safety Instructions
07	Your Washer Dryer
10	Technical Specification
11	Installation
19	Setting Up
25	Usage
62	Maintenance
69	Clothing Care
73	Troubleshooting
81	Guarantee
83	Index

WELCOME ›

WELCOME ›

Thank you for choosing this Servis Washer Dryer, which has been designed and manufactured to give you many years of trouble-free service.

You may already be familiar with using a similar product but please take time to read these instructions, which have been written to ensure you get the very best from your purchase.

PowerDry
Technology

PowerDry technology allows intensive drying of your garments by accelerating the hot air in your Washer Dryer.

WARRANTY ›

Servis provides you with a guarantee which will protect you should your Washer Dryer develop an electrical or mechanical fault during the guarantee period. To ensure that you get a prompt and efficient service, please register your Washer Dryer immediately.

You will find a warranty card included within the packaging. To register, complete the form, or:

- » Visit us at www.servis.co.uk
- » Call us on 0800 0124 382.

SAFETY INSTRUCTIONS ›

ITEMS INCLUDED ›

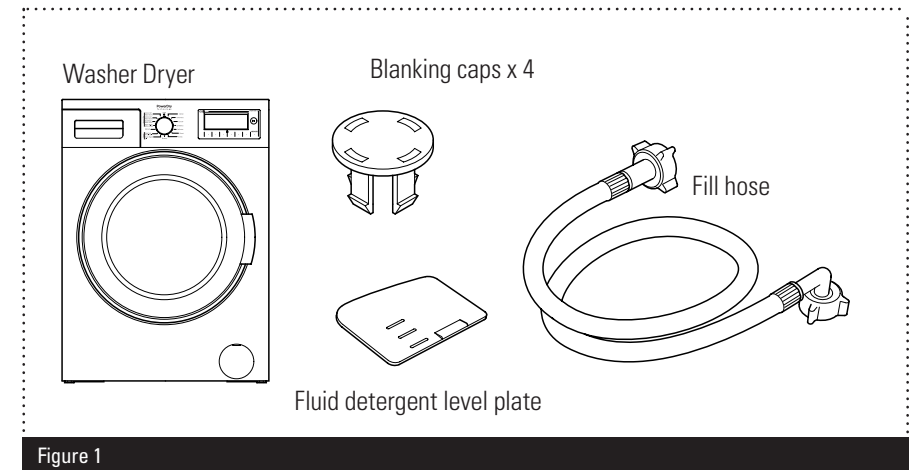

SAFETY INSTRUCTIONS ›

To ensure your safety and the safety of others, please read the following safety precautions before you operate your Washer Dryer.

- » Your Washer Dryer conforms to current safety requirements. Inappropriate use can, however, lead to personal injury and damage to property. To avoid the risk of accidents and damage to your Washer Dryer, read this user guide carefully before using it for the first time. It contains important information on the installation, safety, use and maintenance of your Washer Dryer. Retain this user guide for future use and pass it on to any new owners. Read this user guide before using or installing your Washer Dryer.

SAFETY INSTRUCTIONS ›

- » Your Washer Dryer is for domestic use only and is only intended to wash and dry items which are specified by the manufacturer to be machine washable and dryable on the label, and textiles composed of hand washable wool or wool blend fabrics as well as satin, lace, silk and other hand-washable garments. Do not use your Washer Dryer for any purpose not expressly specified in this user guide.
- » Keep children away from your Washer Dryer when in use. To avoid risk of injury do not allow children to play on or near it or to play with its controls.
- » Before setting up your Washer Dryer, check for any external visible damage. Do not install or use your Washer Dryer if it is damaged. Prolonged intensive use of your Washer Dryer may call for additional ventilation.
- » Before connecting your Washer Dryer, ensure that the information on the data plate (voltage and connected load) matches that of the mains electricity supply. If in doubt, consult a qualified electrician.
- » Do not connect your Washer Dryer to the mains electricity supply using an extension lead.
- » A damaged power cord/plug can cause fire or give you an electric shock. When damaged it must be replaced. This should only be done by qualified personnel.
- » Never remove the plug from the socket by pulling the cord. Always hold the plug.
- » Never touch the power cord/plug with wet hands as this could cause a short circuit or electric shock.
- » Do not touch your Washer Dryer if your hands or feet are wet.
- » Never open the detergent drawer while the machine is running.
- » Faulty components must only be replaced by a suitably qualified Service Agent using genuine spare parts.
- » Unauthorised repairs could result in unforeseen dangers for the user. Repairs should only be undertaken by an approved service agent.
- » In the event of a fault or for cleaning purposes, your Washer Dryer is only completely isolated from the electricity supply when it is unplugged from the mains.
- » Your Washer Dryer must only be connected to your water supply using the supplied new fill hose. Old hoses must not be reused.
- » Do not make any alterations to your Washer Dryer, unless authorised to do so by Servis.
- » The packaging of the machine could be hazardous to children. Please refer to the disposal instructions on the rear cover.
- » Please ensure that you have removed all of the packaging materials and protective tape from the outside of your Washer Dryer, inside the drum and inside the detergent drawer before using.
- » Your Washer Dryer is not intended for use by people (including children) with reduced physical, sensory or mental capabilities, or lack of experience or knowledge, unless they have been given supervision or instruction concerning the use of your Washer Dryer by a person responsible for their safety. Children should be supervised to ensure they do not play with your Washer Dryer.

SAFETY INSTRUCTIONS >

- » You must remove the transit bolts before using your Washer Dryer for the first time. Your Washer Dryer will malfunction if operated with the transit bolts still in place.
 - » The necessary ambient temperature for operation of your Washer Dryer is 15-25 °C.
 - » Please ensure that garments loaded into your Washer Dryer are free from foreign objects such as nails, needles, lighters and coins.
 - » Residue may build up on detergent and softeners exposed to air for a long period of time. Only put softener or detergent in the drawer at the beginning of each wash.
 - » Keep the document bag that contained this user manual out of reach of children and babies to prevent the risk of suffocation.
 - » Keep the small items found in the document bag out of reach of small children and babies.
 - » Do not exceed the maximum load for the washing or drying programme you have chosen.
 - » Never force the door open when your Washer Dryer is running.
 - » Please follow the manufacturers' instructions regarding the use of fabric conditioner or any similar products that you intend to use in your Washer Dryer.
 - » Do not stop your Washer Dryer before the drying phase of a programme has been completed.
 - » Do not touch the drain hose or any discharged water while your Washer Dryer is running. The high temperatures involved pose a burn risk.
 - » Open the drum door fully after the drying process. Do not touch the door glass. It will reach high temperatures and pose a burn risk.
 - » Do not keep flammable or explosive chemicals near your Washer Dryer.
 - » Thoroughly rinse off any chemicals such as stain remover from your garments before beginning a washing and drying programme.
 - » Do not use a detergent ball/device if you have selected a washing and drying programme as this may cause a fire hazard.
- Do not dry your laundry under the conditions specified below as they present a fire risk:
- » If the laundry is not washed.
 - » If oil based stains are not pre-treated before beginning a washing or drying programme.
 - » Laundry that has a high amount of sponge, foam, rubber or rubber like parts and accessories.
 - » Rubber, sponge, latex, shower bonnets, watertight textile products, rubber based objects and clothes or pillows filled with rubber sponge must not be dried in your Washer Dryer.

YOUR WASHER DRYER >

FRONT VIEW >

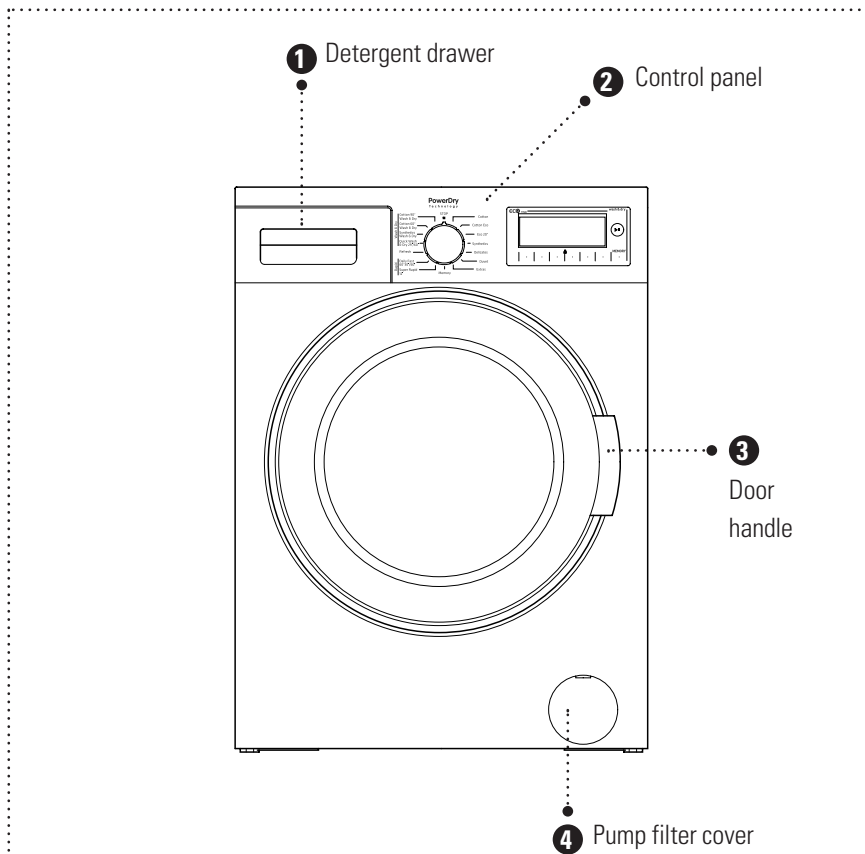

- 1 Detergent drawer; allows you to insert detergent, fabric conditioner and starch.
- 2 Control panel; allows you to configure the required settings for your washing and drying.
- 3 Door handle; provides you with access to the drum.
- 4 Pump filter cover; provides access to the pump filter for maintenance purposes.

Figure 2

REAR VIEW >

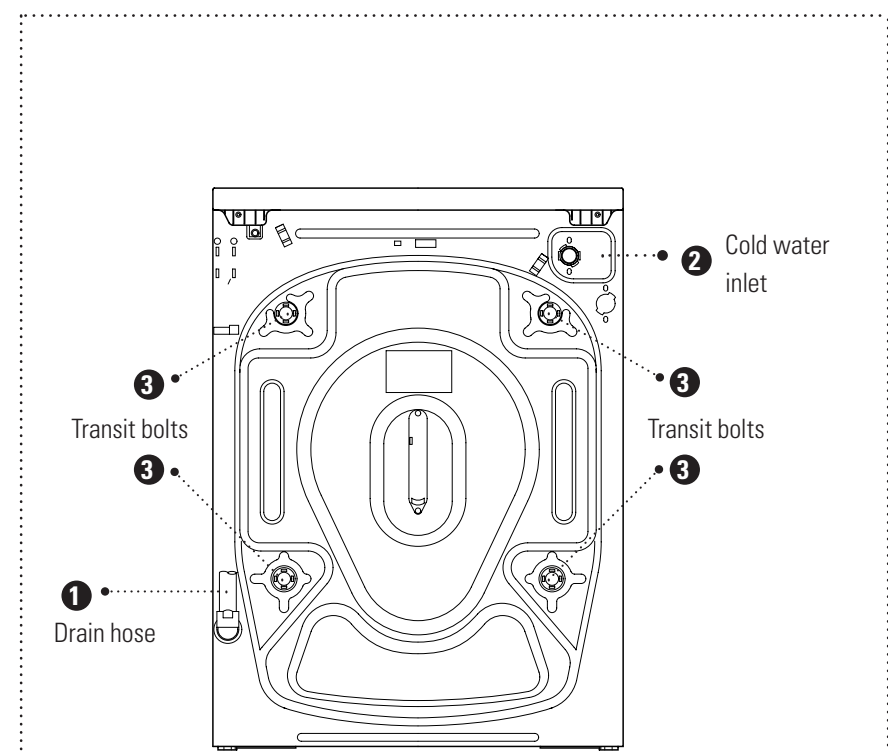



- 1 Drain hose; provides an outlet for the dirty water from your Washer Dryer.
- 2 Cold water inlet; connects your Washer Dryer to your cold water supply.
- 3 Transit bolts; please remove before using your Washer Dryer.

Figure 3

DETERGENT DRAWER >

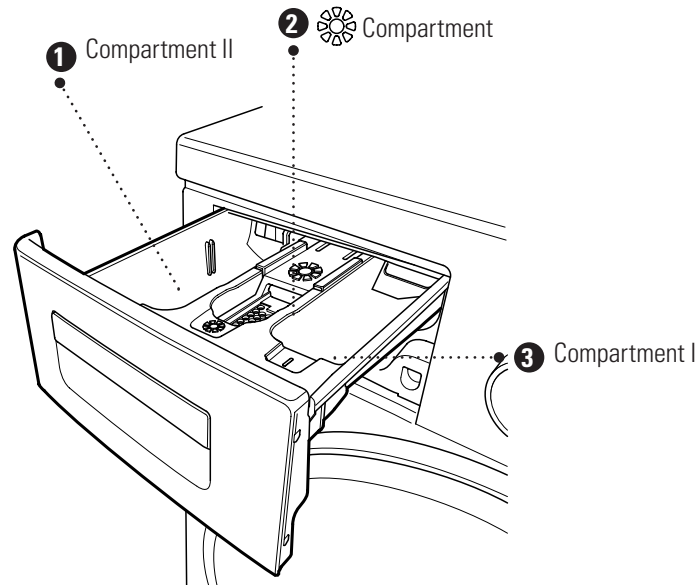
TECHNICAL SPECIFICATION >



- 1 Compartment II; add detergent for the main wash.
- 2  Compartment; for fabric conditioner and liquid starch.
- 3 Compartment I; add detergent for the pre-wash.

Voltage V/Frequency (Hz)	220-240V/50Hz
Electrical Current (A)	10
Power Rating (W)	2200
Water Consumption (l/Cycle) (Washing and Drying)	112
Energy Consumption (kWh/Cycle) (Washing and Drying)	6.12
Unpacked Dimensions (H x W x D) (cm)	84.5 x 59.7 x 58.2
Gross Weight (kg)	81
Spin Speed (rpm)	1400
Drum Volume (lt)	61
Max Load Capacity (Washing) (kg)	9
Max Load Capacity (Drying) (kg)	6
Energy Rating	A
Washing Efficiency	A
Washing Noise (dBA)	58
Spin Noise (dBA)	77
Drying Noise (dBA)	64

Figure 4

INSTALLATION >

INSTALLATION REQUIREMENTS >

To avoid risk of injury, please take care when moving your Washer Dryer. It is heavy and we recommend that a minimum of two people move your Washer Dryer.

To unpack your Washer Dryer and manoeuvre it to the installation area, one person should hold it by the front feet and the other person at the edge of the lid at the rear.

Your Washer Dryer measures 84.5 x 59.7 x 58.2cm and will require an installation area with the space to allow the door to fully open and provide easy access to the plumbing and electrical connections.

The most suitable installation surface for your Washer Dryer is a concrete floor as it is less prone to vibration during the spin cycle. Soft floor surfaces such as carpets and rugs are not suitable.

If you have to install your Washer Dryer on a wooden floor, we recommend that a water-resistant wooden base at least 30mm thick is installed. The base should span several joists and be bolted down. Check for the presence of pipes and cables before installing.

If possible, install your Washer Dryer in the corner of the room as it is often the most stable part of the floor.

Do not install your Washer Dryer in rooms where temperatures below freezing may occur as frozen hoses may burst or split.

REMOVAL OF TRANSIT BOLTS >

The transit bolts are used to protect your Washer Dryer from damage during transportation and must be removed before using your Washer Dryer for the first time. Keep the transit bolts safe and re-fit them if you need to transport your Washer Dryer in the future.

The four transit bolts are located on the back of your Washer Dryer (fig 5a).

To remove the transit bolts (4 off):

- 1 Remove each bolt by turning anti-clockwise with a suitable spanner (fig 5b).

- 2 Pull out the remaining plastic section of each transit bolt by hand. This will require a reasonable amount of force (fig 5c).
- 3 Insert the blanking caps (4 off): Push the cap into the hole until the four connectors click into place. Check that the cap is flush with the Washer Dryer.

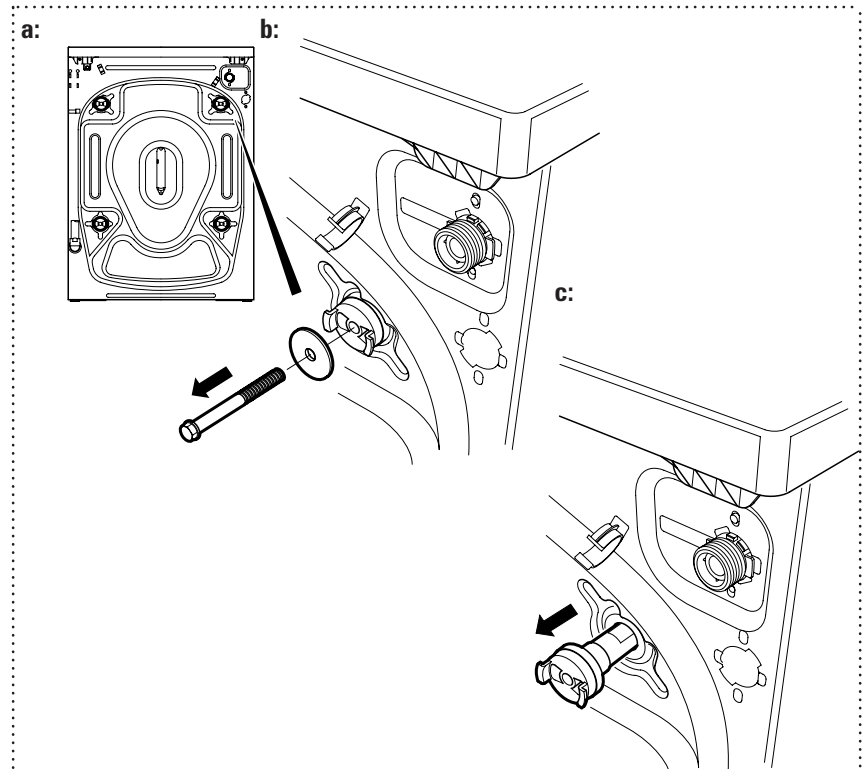

Figure 5

To re-fit the transit bolts (4 off) for future transportation:

- 1 Pull and remove the four plastic blanking caps.
- 2 Insert the plastic sections of the transit bolts into the exposed holes.
- 3 Insert the bolts into the plastic sections of the transit bolts and tighten with a suitable spanner until secure.

INSTALLATION >

ADJUSTING THE FEET >

For safe operation, it is important that your Washer Dryer is level and securely positioned on all four feet. Incorrect installation may cause the Washer Dryer to vibrate and increase your water and electricity consumption. Never place cardboard, wood or similar materials under your Washer Dryer to increase stability.

The four adjustable feet are used to level the Washer Dryer. To adjust the feet:

- 1 Loosen the plastic locking nut by turning anti-clockwise (fig 6a).
- 2 To increase the height of the machine, turn the feet anti-clockwise (fig 6b).
- 3 To decrease the height of the machine, turn the feet clockwise (fig 6b).
- 4 After making adjustments, use a spirit level to check that the machine is level.
- 5 Once the machine is level, tighten the locking nuts by turning clockwise (fig 6c).

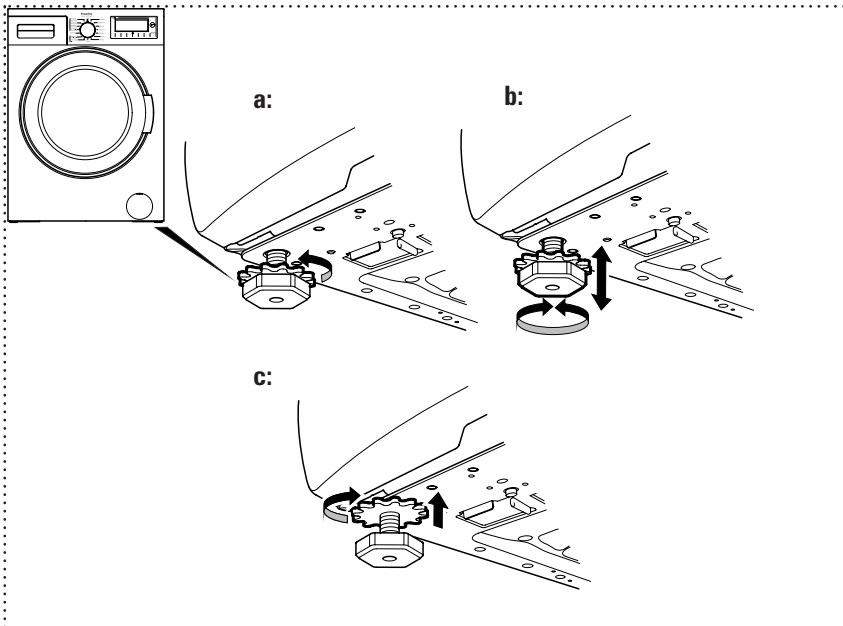

Figure 6

WATER SUPPLY CONNECTION >

Your Washer Dryer uses an energy efficient cold fill system, which means that only the water required to wash the laundry is heated. As a result, no heat is lost in the pipeline from the hot water supply.

Connect your Washer Dryer to your cold water supply only. If your previous machine had a hot and cold fill, check that the hot tap on your water supply is closed to avoid leakage. Only use the fill hose supplied and not one from your old Washer Dryer. Only one hose is required to install your Washer Dryer to the cold water supply. The inlet hose provided with your Washer Dryer connects the rear of your machine and the cold water supply.

To connect your Washer Dryer to the cold water supply:

- 1 Connect the angled end of the fill hose to the cold water inlet on the rear of your Washer Dryer by screwing the threaded connector clockwise (fig 7). Take care not to overtighten the connection. Hand tight is sufficient.

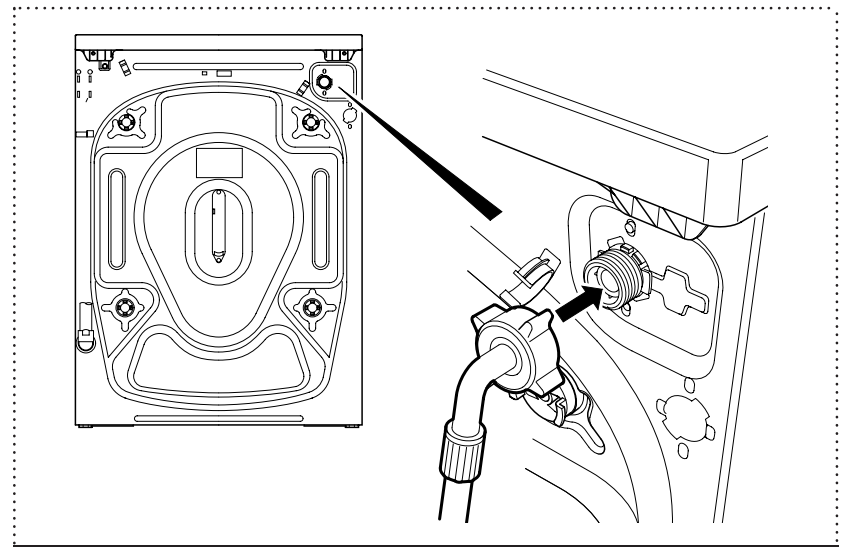

Figure 7

INSTALLATION >

WATER SUPPLY CONNECTION >

- 2 Screw the straight end of the hose clockwise to a 19mm (3/4") cold water tap until hand tight (fig 8). Take care not to trap or kink the hose.

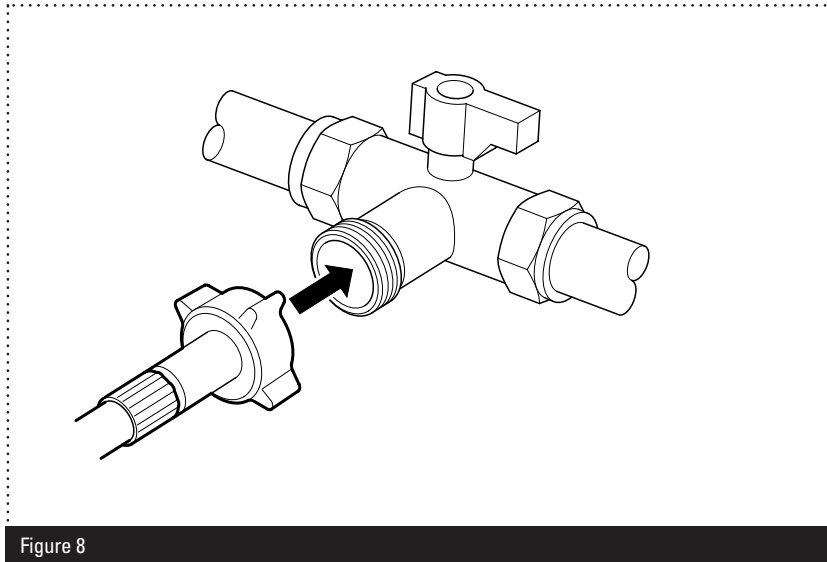

Figure 8

DRAIN HOSE CONNECTION >

Do not connect your Washer Dryer to a surface water drain.
Connect your Washer Dryer to your household drainage system (fig 9).
For your Washer Dryer to function properly the outlet end of the drain hose must be at a minimum of 60cm and a maximum of 100cm from the ground.

CAUTION: Check to ensure that the hose is not trapped, kinked, twisted, folded or crushed.
Do not attempt to extend the drain hose by adding extra sections.

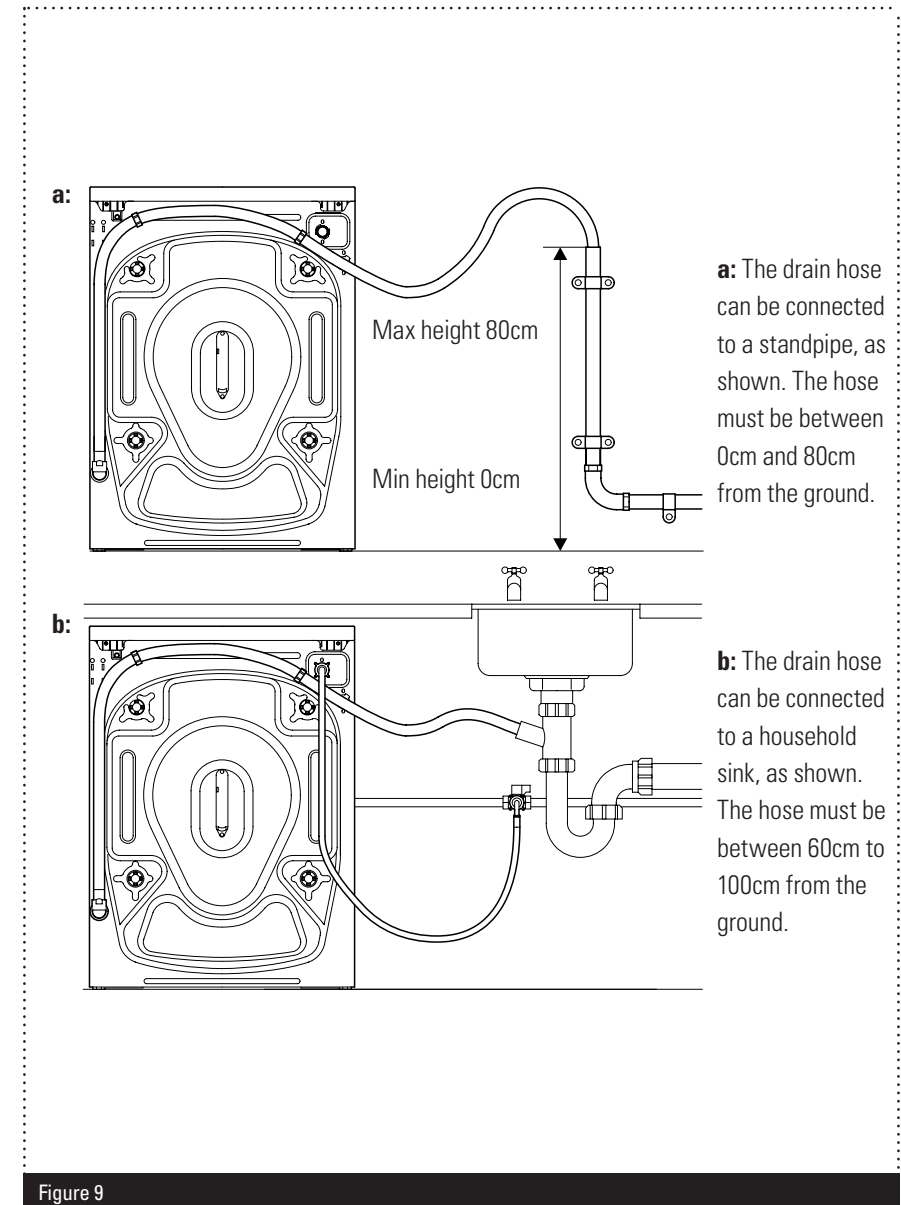

Figure 9

INSTALLATION >

The cold water pressure for a normal household system ranges from between 0.1 to 1 Mpa. Your Washer Dryer will run at optimum efficiency in this range.

Once you have made all of the connections, carefully turn your cold water supply on and check for leaks.

ELECTRICAL CONNECTION >

- » Your Washer Dryer requires a 220-240V, 50Hz mains supply. Do not use any other supply.
- » Your Washer Dryer may be fitted with a moulded plug, which cannot be rewired.
- » If the fuse cover becomes damaged, you must not use the plug.
- » If your plug requires changing because it is not suitable for your socket, or it is damaged, you should consult a qualified electrician.

Fuse:

- » Replacement fuses should be ASTA-approved to BS1362 and have the correct 10 Amp rating.
- » Replacement fuses can be purchased from an electrical supplier.

SETTING UP ›

CONTROL PANEL OVERVIEW ›

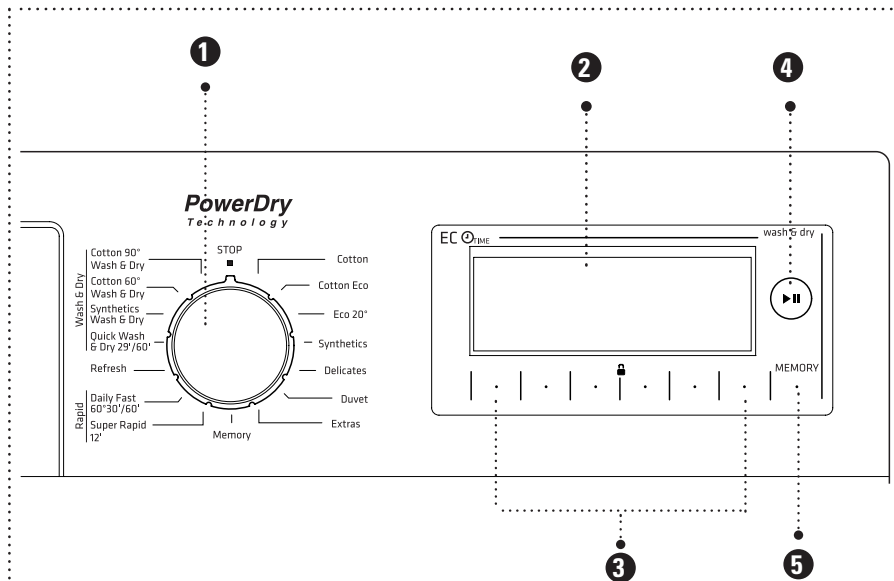

- 1 Programme Dial; Allows you to select a washing and drying programme.
- 2 Information Screen; Displays details of the selected programme and information on the status of your Washer Dryer.
- 3 Smart Touch Function Buttons: Allow you to select or adjust a particular function.
- 4 Start/Pause Button: Start or Pause the selected programme.
- 5 Memory Button: Allows you to store preferred settings.

USING THE SMART TOUCH BUTTONS ›

A series of 6 smart touch buttons can be found below the information screen. To make a selection, press the button below the desired selection choice on the information screen. For example, if the instructions in this user manual say 'Press the ✓ button' press the button directly below the ✓ symbol.

SETTING UP YOUR WASHER DRYER ›

Your Washer Dryer has a range of adjustable features that can be altered to suit your preferences. To make the initial settings please ensure that:

- 1 The transit bolts have been removed.
- 2 Your Washer Dryer has been correctly connected to your water supply and your water drainage system.
- 3 Your Washer Dryer has been connected to an appropriate mains power supply and is switched on at the socket.
- 4 The programme dial is turned on i.e. is not in the 'STOP' position.

Current Time Setting ⌚

We recommend that you set the correct time during the initial set-up of your Washer Dryer. After turning your Washer Dryer on for the first time it will check to see if you would like to set the current time 'set day time' will be displayed on the information screen (fig 11).

- › To set the current time, press the ✓ button. Alternatively, press the ✕ button to exit without setting the time.

Figure 10

SETTING UP >

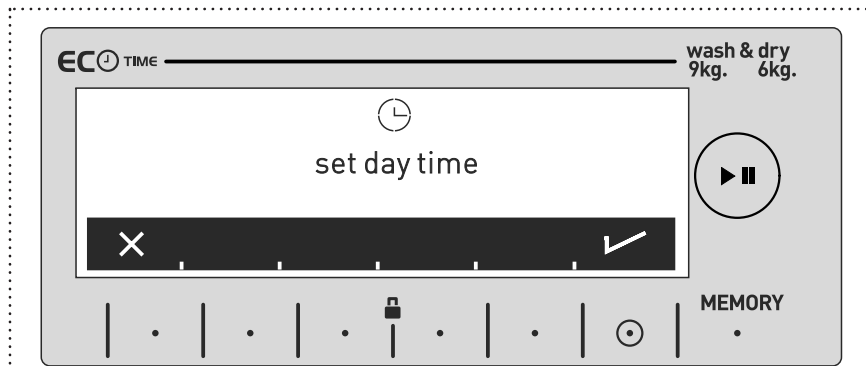

Figure 11

If you have chosen to set the current time:

- » Press the > button under the hour setting until it displays the current hour.
- » Press the > button under the minute setting until the current time is shown.
- » To confirm the current time setting, press the ✓ button.

Once you have set the current time, your Washer Dryer will automatically display the main screen of the programme selected by the programme dial. If you would like to make further changes to your settings, press the ≡ button and use the → button to select the setting you wish to alter.

You can change the current time setting at any time by pressing the ≡ button from the main programme screen and selecting the → button until the time is displayed. Use the > buttons to increase the hours and minutes.

Please Note: We strongly recommend that you set the current time accurately as other operating features depend on it.

Time setting information will be lost if you leave your Washer Dryer unplugged for more than 15 days. In this case you will be prompted to set the time when you next turn your Washer Dryer on.

Language Selection Setting

To select the language used on the information screen, press the ≡ button. When setting the language for the first time 'Select Language' will appear on the information screen (fig 12).

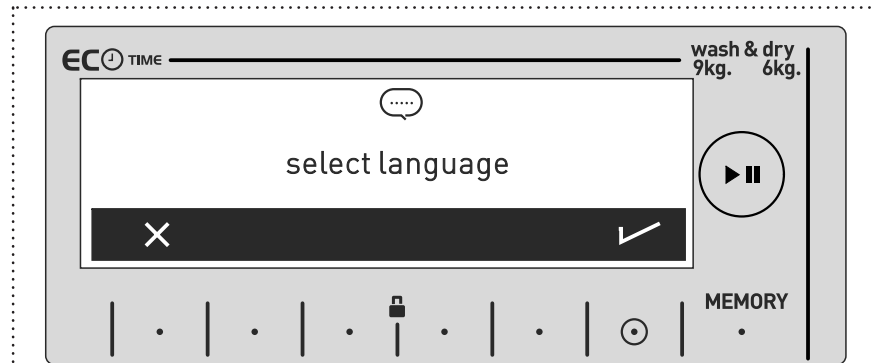

Figure 12

To change the current language setting press the ✓ button.

To exit the language selection screen without making a selection, press the X button.

If you have chosen to change the current language setting:





- » You can cycle through the available languages using the < and > buttons.
- » Press the ✓ button to select the desired language.
- » You will be asked to confirm the language selected, for example 'Change to Turckce?'
- » Press the ✓ button to confirm the selection, or the X button to cancel the selection and make another choice.

You can change the language at any time by pressing the ≡ button. The current language selection will be displayed, for example 'English'. Press the < and > buttons to cycle through the available languages and use the ✓ button to select your choice.

SETTING UP >

Eco Time Setting (Economic Time Interval) ^{ECO TIME}

To help make savings on your energy bills, your Washer Dryer contains an Eco Time Setting. This allows you to set your Washer Dryer to run during the hours when your electricity tariff is more economical. Please be aware that a smart counter will be required in order for this mode to work. When setting the Economic Time Interval for the first time:

- » Press the  button on the main programme screen and use the  button until ^{ECO TIME} and 'set economic time zone' is displayed on the information screen.
- » Press the  button to set Eco Time, or the  button to return to the main programme screen.

If you have chosen to set Eco Time:

- » ^{ECO TIME} and the start and end time of the economic time interval will be displayed on the information screen (fig 13).

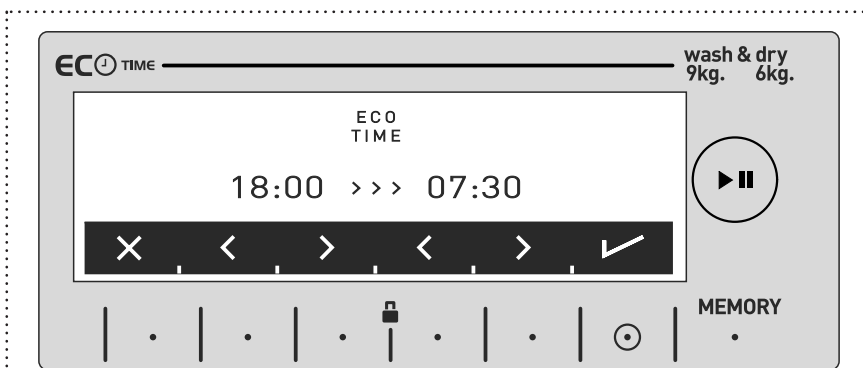









Figure 13











- » Use the  and  buttons to set the start and finish time for the economic time interval.
- » Press the  button to confirm the selection, or the  button to return to the main programme screen.

You can change the Eco Time hours at any time by pressing the  button from the main programme screen and using the  button until the Eco Time hours are displayed. Use the  and  buttons to set the desired Eco Time interval.

To activate the Eco-Time setting, please refer to the information on additional functions on page 53.





Sound Adjustment

You can choose to turn the warning sounds of your Washer Dryer on or off. To access the sound settings:

- » Press the  button on the main programme screen and then press the  button until the sound adjustment settings are displayed. This is shown by the  and  symbols on the information screen. Alternatively, if you are already in the settings menu, simply use the  button to navigate to the sound adjustment settings.
- » Use either the  or  buttons to toggle the warning sounds on or off. A  symbol and 3 audible beeps indicates that the warning sounds are turned on. A  symbol indicates that the warning sounds are turned off.
- » To return to the main programme screen, press the  button, or press the  button.

Screen Brightness Setting

You can adjust the brightness setting of the information screen on your Washer Dryer:

- » Press the  button on the main programme screen and then press the  button until the brightness setting screen is displayed. This is shown by the  symbol. Alternatively, if you are already in the settings menu, simply use the  button to navigate to the brightness

- » Use the < button to decrease the brightness of the information screen, or the > button to increase the brightness. The information screen displays a bar showing the level of brightness selected (fig 14).

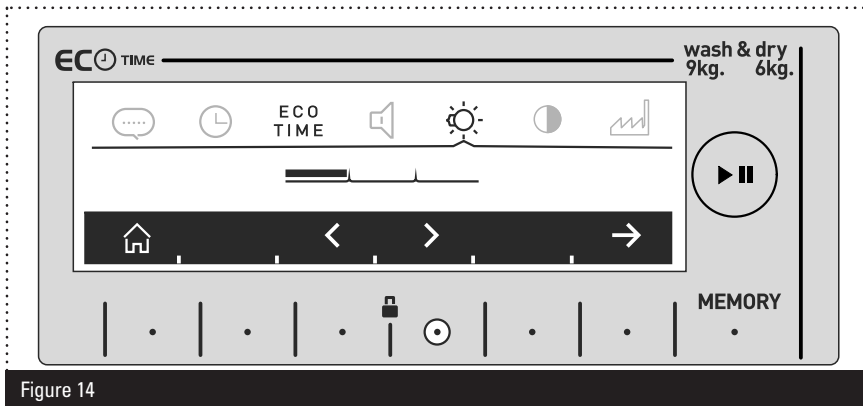

Figure 14

- » To return to the main programme screen press the home button, or press the > button to select another setting you wish to alter.

Screen Contrast Setting

You can adjust the contrast of the information screen on your Washer Dryer:

- » Press the menu button on the main programme screen and then press the > button until the contrast setting screen is displayed. This is shown by the sun symbol. Alternatively, if you are already in the settings menu, simply use the > button to navigate to the contrast settings.
- » Use the < button to reduce the level of contrast, or the > button to increase the level of contrast.
- » To return to the main programme screen, press the home button or press the > button to select another setting you wish to alter.

Revert to Factory Settings

You have the option to revert your Washer Dryer to the factory default settings:

- » Press the menu button on the main programme screen and then press the > button until the screen shown in fig 15 is displayed. If you are already in the setting menu, simply use the > button to navigate to the factory settings screen.

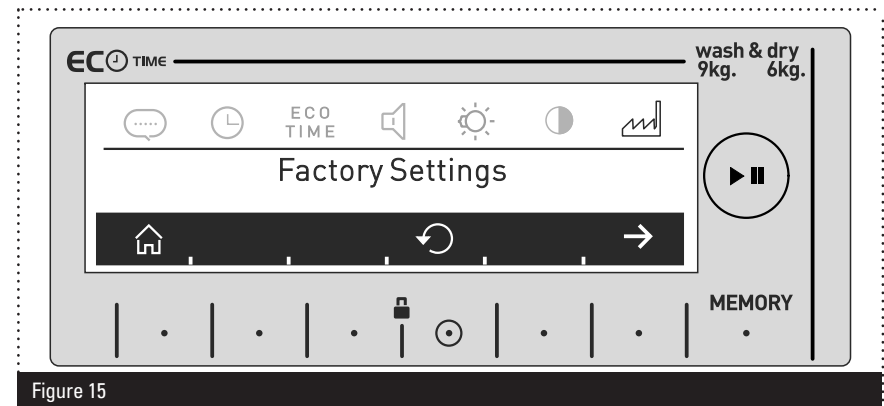

Figure 15

- » Press the circular arrow symbol to reset your Washer Dryer to factory settings. You will be asked to confirm your choice. 'Reset to Factory Settings?' will be displayed on the information screen. Press the checkmark button to confirm your selection or the X to cancel.
- » You can return to the main programme screen by pressing the home button.

RUNNING YOUR FIRST WASH >

Before using your Washer Dryer for then first time; please check that:

- 1 The transit bolts have been removed.
- 2 Your Washer Dryer has been correctly connected to your water supply and your water drainage system.
- 3 Your Washer Dryer has been connected to an appropriate mains power supply and is switched on at the socket.

Tests were carried out on your Washer Dryer at the factory; as a result, water may be left in the machine. To remove any water we recommend that the first wash is carried out without any laundry:

- 1 Open the detergent drawer, pour in half a measuring cup of all-purpose detergent into compartment II and close the drawer.
- 2 Select the 'Drum Cleaning' programme by turning the programme dial to extras. 'drum clean' will be displayed on the information screen.
- 3 Press the → button to select the programme.
- 3 Press the ▶|| button to begin the programme.

WASHING SEQUENCE >

Please follow the steps suggested to get the best results from your washing.

Preparing your Laundry:

CAUTION: Please be aware that any foreign objects such as coins or paper clips can cause damage to your garments and components in your Washer Dryer.

- » Empty all pockets on items of clothing, brush out any sand and dirt from pockets and cuffs.
- » Close zips and fasten any hooks and eyes.
- » Items such as trousers, t-shirts, sweat shirts and knitted garments should be turned inside out.
- » Remove any weights from curtains, or place in a laundry bag.
- » Any loose wiring in bras and shirt collar stiffeners should be removed or sewn in.



Sorting your Laundry:

- » Sort your laundry by colour. Always wash whites and coloureds separately.
- » Dark textiles may contain excess dye and should be washed separately several times before being included in a mixed load.
- » Follow the instructions given in the care labels on the clothing.
- » Do not wash any items in the machine that the manufacturer has specified as non-washable on the care label.
- » Do not dry any items in the Washer Dryer that the manufacturer has specified as non-dry on the care label.
- » Badly soiled or stained areas can be pre-treated with liquid detergent or stain removers by following the manufacturer's instructions.
- » If you use a solvent-based cleaning agent to pre-treat a stain, protect any plastic parts such as buttons. Rinse the cleaning agent off before loading the washing into the machine.
- » Do not use a solvent-based cleaning agent in your Washer Dryer.

Loading the Drum:

- 1 Pull the door open using the handle.
- 2 Select a programme before loading laundry into your Washer Dryer. If you do not select a programme the load sensor will not be activated.
- 3 Load your items of clothing into the drum, ensuring they are loosely packed. You will achieve better wash results if you mix up large and small items. Items of varying size will help distribute the load more evenly during spinning.

Take care not to exceed the maximum load of the drum as this will give poor wash results and cause creasing. Refer to the tables on 37 to 48 for information on load capacities for the various programmes.

The maximum load capacity of your Washer Dryer may change according to the programme you have selected. If you exceed the load capacity of the selected programme a  symbol will be displayed on the information screen accompanied with a warning sound. If this should occur, we recommend that you remove items of laundry until the  symbol disappears.

Your Washer Dryer contains a load detection system. This sophisticated system measures the weight of the laundry inside your washer dryer and displays the increase in load on the information screen. Your Washer Dryer automatically adjusts programme features such as programme duration, energy consumption and water consumption according to the load.

- 4 Once you have loaded the drum gently push the door until it clicks shut (there will be an audible beep if the sound settings are turned on). Check that no items of clothing are trapped between the rubber seal and the door.

Adding Detergent:

Please take care to add the correct amount of detergent to your Washer Dryer.

If too little detergent is added:

- » Your laundry may not get washed properly and may become grey and stiff over time.
- » Spots of fat may appear on your laundry.
- » Limescale may form on the heater elements.

If too much detergent is added:

- » Excessive foam will be formed resulting in poor wash results.
- » Water consumption will increase.

You can use any detergent produced for automatic washing machines. The use of dispensing aids such as balls is recommended, if they are supplied with the detergent.

Please Note: Do not use a dispensing aid if you have selected a programme with a drying function as this could pose a fire risk.

Tablets are suitable for full loads; however, it may be impractical to reduce them for smaller loads. Some tablets do not dissolve as quickly as others and may not be suitable for wash cycles of short duration.

It is possible to use fluid detergents in all programmes without a pre-wash. To do this, slide the fluid detergent level plate into the guides in compartment II of the detergent drawer (fig 16). Use the lines on the plate as a guide to fill the drawer to the required level.

The amount of detergent to use will depend on the dirtiness of your clothes and the hardness of your water supply; guidelines will be on the packaging of your detergent.

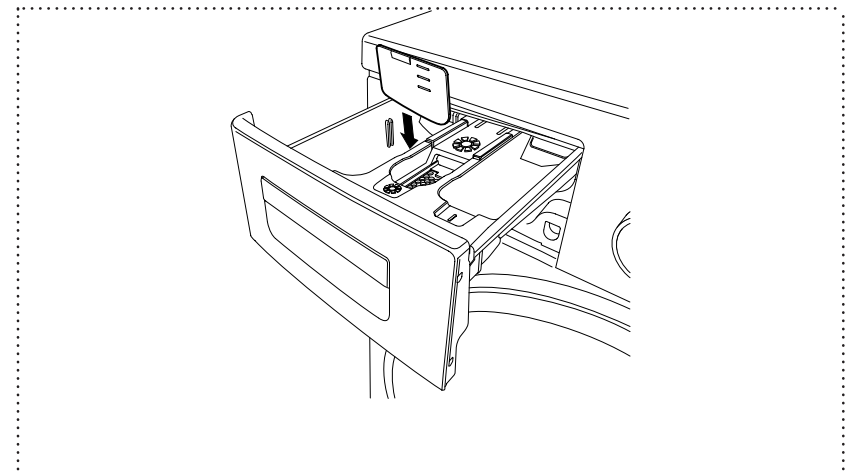

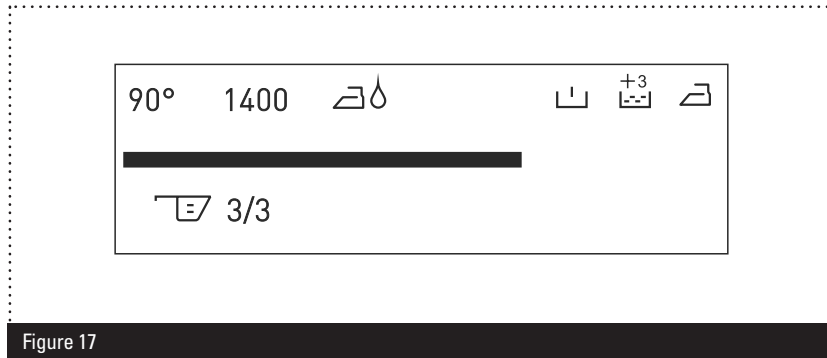

Figure 16

USAGE >

- » If your clothes are only slightly soiled, do not prewash and put a small amount of detergent, as specified by the manufacturer, into compartment II of the detergent drawer.
- » If your clothes are excessively soiled, select a programme with pre-wash and put ¼ of the detergent to be used into compartment I of the detergent drawer and the rest in compartment II.

Your Washer Dryer contains a system to help you select the correct quantity of detergent based on the weight of your laundry. The information screen displays a  symbol and indicates how much detergent is required (1/3, 2/3 or 3/3). For example, the screen in fig 17 recommends that you fill the detergent drawer to the MAX level.



Water Softener:

A water softener can be used to reduce the amount of detergent required in hard water areas. Follow the guidance on the packaging and dispense as instructed. First add the detergent, then the water softener.

Fabric Conditioners and Liquid Starch:

- » Fabric conditioners make garments soft to handle.
- » Starch stiffens and gives body to items such as bed linen.

To add fabric conditioner or liquid starch, pour the amount as instructed on the packaging into the  compartment of the detergent drawer, taking care not to exceed the MAX level.

Selecting a Programme:

To select the desired programme, turn the programme dial either clockwise or anti-clockwise until the marker on the dial points to the chosen programme.



- » The programme name and features will be displayed on the information screen.
- » For some programmes you can adjust the water temperature by pressing the  button. The selected temperature will be displayed in the top left corner of the information screen.
- » For some programmes you can adjust the spin speed by pressing the  button. The selected spin speed will be displayed on the top of the information screen.

Figure 18 shows the information screen when the cotton programme is selected, the temperature shown is 90 °C and the spin speed 1400 rpm.

Please Note: For more information on available temperature and spin speed settings for individual programmes, refer to the tables on 37 to 48.

After setting the spin speed, if you select a drying programme, your machine will select the spin speed automatically to enhance drying performance,

USAGE >



Figure 18

DRYING YOUR WASHING >

If you would like your laundry dried at the end of a washing programme you have several options available. When you have selected the desired programme:

» Press the  button until one of the following symbols appears on the information screen:

 **Cupboard Dry:** Recommended for laundry that you will put directly in a cupboard after taking out of your Washer Dryer.

 **Hanger Dry:** This is recommended for laundry that requires hanger drying.

 **Iron Dry:** Select this option for laundry that you will iron after washing.

Please Note: if the desired drying symbol is not displayed as you use the  button to cycle through the options, it means that the feature is not available for the washing or drying programme you have selected.

» To cancel a drying function, press the  button until the information screen returns to the main programme page.

Drying with Duration

If you would like to set the duration of a drying programme:

- » Press the  button until the desired drying time is displayed.
- » Drying selections will be displayed on the top of the information screen as 30min 60min or 120min

Figure 19 shows the information screen when a drying time of 30 minutes has been selected.

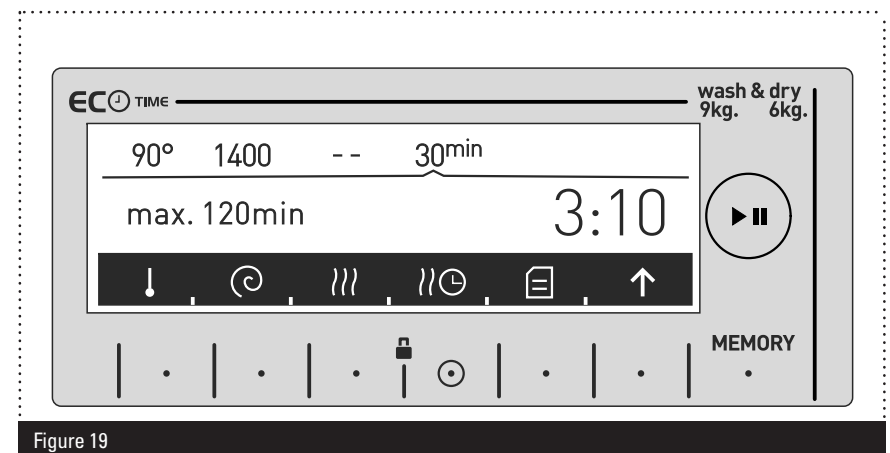

Figure 19

Please note: If one of the 30^{min} 60^{min} 120^{min} symbols is not displayed, it means that the drying duration is not appropriate for the programme you have selected or the load in your machine.

Duration Drying Programs

Amount of laundry to dry	Recommended drying times
1 kg	30 minutes
2 kg	60 minutes
3.5 kg	120 minutes

If the amount of laundry to be dried is above 3.5 kg, it is advised that cupboard, hanger or iron drying is selected.

To cancel a drying with duration function, press the  button until the information screen displays the main programme page,

Programme Modes and Information

The following tables provide helpful information on the individual programmes.

- » Please be aware that when you wish to select more than one additional function, they may not be compatible with one another.





The programme duration may change due to:

- » The amount of laundry in your Washer Dryer.
- » The hardness of the water.
- » The ambient temperature.
- » The selected additional functions.



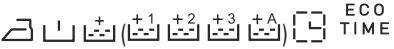

- » Do not dry towels, cotton and synthetic clothes together. Select the most appropriate drying programme for the clothes.
- » The programme factory settings are shown in **bold type**.

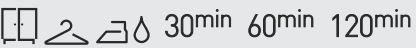
USAGE >

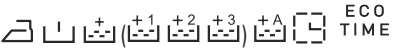

Cotton

Selectable Washing Temperatures (°C)	 (Cold Water), 30°, 40°, 60°, 90°*
Maximum Washing/Drying Capacity (kg)	9.0/6.0
Selectable Spin Speed (rev/min)	 (No Spin), 400, 600, 800, 1000, 1200, 1400*
Laundry Type/Descriptions	Heat resistant cotton and linen textiles (underwear, bedding, tablecloths and towels) (max 4.0 kg)
Selectable Additional Functions**	 
Selectable Drying Functions**	 30min 60min 120min

Cotton Eco

Selectable Washing Temperatures (°C)	 (Cold Wash), 30°, 40°, 60°*
Maximum Washing/Drying Capacity (kg)	9.0/6.0
Selectable Spin Speed (rev/min)	 (No Spin), 400, 600, 800, 1200, 1400*
Laundry Type/Descriptions	Cotton and linen textiles (underwear, bedding, tablecloths, towels) (max 4.0 kg)
Selectable Additional Functions**	 
Selectable Drying Functions**	 30min 60min 120min

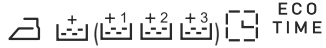
Eco 20°

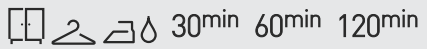
Selectable Washing Temperatures (°C)	20°*
Maximum Washing/Drying Capacity (kg)	4.0/4.0
Selectable Spin Speed (rev/min)	 (No Spin), 400, 600, 800, 1200, 1400*
Laundry Type/Description	Less dirty, cotton and linen textiles (bedding, tablecloths and towels) (max 2.0 kg)
Selectable Additional Functions**	 
Selectable Drying Functions**	 30min 60min 120min

(*) Programme factory default settings.

(**) When you want to select more than one additional function, the additional functions you wish to select may not comply with each other.

Do not dry towels, cotton and linens, and synthetic and synthetic mix clothes together. For drying select the most appropriate drying programme for the clothes.

NOTE: THE PROGRAMME DURATION MAY CHANGE ACCORDING TO THE AMOUNT OF LAUNDRY, TAP WATER, AMBIENT TEMPERATURE AND SELECTED ADDITIONAL FUNCTIONS.

USAGE >

Synthetics	
Selectable Washing Temperatures (°C)	(Cold Wash), 30°, 40°, 60°*
Maximum Washing/Drying Capacity (kg)	3.5/3.5
Selectable Spin Speed (rev/min)	(No Spin), 400, 600, 800*
Laundry Type/Descriptions	Synthetic and synthetic mix textiles (synthetic content shirt, blouse, socks etc)
Selectable Additional Functions**	(+1) (+2) (+3) (+A) ECO TIME
Selectable Drying Functions**	30min 60min 120min

Curtain***	
Selectable Washing Temperatures (°C)	(Cold Wash), 30°, 40°*
Maximum Washing/Drying Capacity (kg)	2.5
Selectable Spin Speed (rev/min)	(No Spin), 400, 600*
Laundry Type/Descriptions	For washing curtains only.
Selectable Additional Functions**	(+1) (+2) (+3) (+A) ECO TIME
Selectable Drying Functions**	-

(*) Programme factory default settings.

(**) When you want to select more than one additional function, the additional functions you wish to select may not comply with each other.

(***) These are sub-programmes. Refer to page 55 for programme selection.

! Curtain is a programme with a pre-wash programme. Do not forget to add detergent to the pre-wash compartment of the detergent drawer when you use this programme.

Do not dry towels, cotton and linens, and synthetic and synthetic mix clothes together.

For drying select the most appropriate drying program for the clothes.

NOTE: THE PROGRAMME DURATION MAY CHANGE ACCORDING TO THE AMOUNT OF LAUNDRY, TAP WATER, AMBIENT TEMPERATURE AND SELECTED ADDITIONAL FUNCTIONS.

Delicates	
Selectable Washing Temperatures (°C)	Cold Wash), 30°, 40°*
Maximum Washing Capacity (kg)	2.5
Selectable Spin Speed (rev/min)	(No Spin), 400, 600*
Laundry Type/Descriptions	Woollen and wool mix laundry with machine washable labels
Selectable Additional Functions	(+1) (+2) (+3) ECO TIME
Selectable Drying Functions	-

Silk***	
Selectable Washing Temperatures (°C)	(Cold Wash), 30°*
Maximum Washing Capacity (kg)	2.5
Selectable Spin Speed (rev/min)	(No Spin), 400, 600*
Laundry Type/Descriptions	Silk mixture laundry with machine washable labels.
Selectable Additional Functions**	(+1) (+2) (+3) ECO TIME
Selectable Drying Functions**	-

(*) Programme factory default settings.

(**) When you want to select more than one additional function, the additional functions you wish to select may not comply with each other.

(***) These are sub-programmes. Refer to page 55 for programme selection.





Do not dry towels, cotton and linens, and synthetic and synthetic mix clothes together.

For drying select the most appropriate drying programme for the clothes.

NOTE: THE PROGRAMME DURATION MAY CHANGE ACCORDING TO THE AMOUNT OF LAUNDRY, TAP WATER, AMBIENT TEMPERATURE AND SELECTED ADDITIONAL FUNCTIONS.

USAGE >

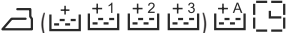
Duvet

Selectable Washing Temperatures (°C)	 (Cold Wash), 30°, 40°*
Maximum Washing Capacity (kg)	2.5
Selectable Spin Speed (rev/min)	 (No Spin), 400, 600, 800*
Laundry Type/Descriptions	For washing a fibre duvet with a machine washable label. (max. 2.5 kg)
Selectable Additional Functions**	 
Selectable Drying Functions**	-

(*) Programme factory default settings.



(**) When you want to select more than one additional function, the additional functions you wish to select may not comply with each other.

Do not dry towels, cotton and linens, and synthetic and sythetic mix clothes together.

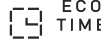

For drying select the most appropriate drying programme for the clothes.

NOTE: THE PROGRAMME DURATION MAY CHANGE ACCORDING TO THE AMOUNT OF LAUNDRY, TAP WATER, AMBIENT TEMPERATURE AND SELECTED ADDITIONAL FUNCTIONS.

Extras

Selectable Washing Temperatures (°C)	-
Maximum Washing/Drying Capacity (kg)	6.0 kg
Selectable Spin Speed (rev/min)	-
Laundry Type	Cotton laundry with machine dryable label.
Selectable Additional Functions	
Selectable Drying Functions	  30min 60min 120min

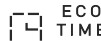
Curtain

Selectable Washing Temperatures (°C)	-
Maximum drying Capacity (kg)	3.5
Selectable Spin Speed (rev/min)	-
Laundry Type/Descriptions	Cotton laundry with machine dryable label.
Selectable Additional Functions**	
Selectable Drying Functions**	  30min 60min 120min

Gentle Dry

(*) Programme factory default settings.

(**) When you want to select more than one additional function, the additional functions you wish to select may not comply with each other.

(***) These are sub-cycles. Refer to page 55 for programme selection.

Do not dry towels, cotton and linens, and synthetic and sythetic mix clothes together.

For drying select the most appropriate drying programme for the clothes.

NOTE: THE PROGRAMME DURATION MAY CHANGE ACCORDING TO THE AMOUNT OF LAUNDRY, TAP WATER, AMBIENT TEMPERATURE AND SELECTED ADDITIONAL FUNCTIONS.

USAGE ›

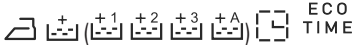
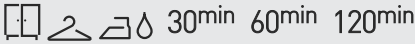
Rinse**	Extras	
	Selectable Washing Temperatures (°C)	-
	Maximum Washing/Drying Capacity (kg)	9.0/6.0
	Selectable Spin Speed (rev/min)	⊘ (No Spin), 400, 600, 800, 1000, 1200, 1400*
	Laundry Type/Description	This programme can be used for additional rinsing after washing.
	Selectable Additional Functions**	 ECO TIME
Selectable Drying Functions**	 30min 60min 120min	

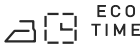
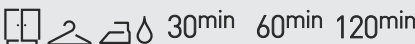
Spin**	Selectable Washing Temperatures (°C)	-
	Maximum washing/drying Capacity (kg)	9.0/6.0
	Selectable Spin Speed (rev/min)	400, 600, 800, 1000, 1200, 1400*
	Laundry Type/Description	This programme can be used for additional spinning after washing.
	Selectable Additional Functions**	 ECO TIME
	Selectable Drying Functions**	 30min 60min 120min

Note: Please refer to the footnotes on page 44 for additional information on settings.

Drain**	Extras	
	Selectable Washing Temperatures (°C)	-
	Maximum Washing/Drying Capacity (kg)	-
	Selectable Spin Speed (rev/min)	-
	Laundry Type/Description	This programme drains your Washer Dryer.
	Selectable Additional Functions	ECO TIME
Selectable Drying Functions	-	

Drum Clean***	Selectable Washing Temperatures (°C)	-
	Maximum washing/drying Capacity (kg)	-
	Selectable Spin Speed (rev/min)	-
	Laundry Type/Descriptions	This is a drum cleaning programme and must be run without laundry.
	Selectable Additional Functions**	ECO TIME
	Selectable Drying Functions**	-

(*) Programme factory default settings.

(**) When you want to select more than one additional function, the additional functions you wish to select may not comply with each other.

(***) These are sub-programmes. Refer to page 55 for programme selection.

Do not dry towels, cotton and linens, and synthetic and synthetic mix clothes together.



For drying select the most appropriate drying programme for the clothes.

NOTE: THE PROGRAMME DURATION MAY CHANGE ACCORDING TO THE AMOUNT OF LAUNDRY, TAP WATER, AMBIENT TEMPERATURE AND SELECTED ADDITIONAL FUNCTIONS.



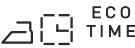
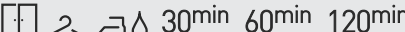

USAGE >

Rapid***

Super Rapid 12 min

Selectable Washing Temperatures (°C)	 (Cold Wash), 30°*
Maximum Washing/Drying Capacity (kg)	2.0/2.0
Selectable Spin Speed (rev/min)	 (No Spin), 400, 600, 800*
Laundry Type	For washing less dirty cotton, coloured and linen textiles in a little as 12 minutes. Note: As the washing time is short, less detergent is required than in other programmes.
Selectable Additional Functions	
Selectable Drying Functions	 30min 60min 120min

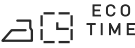
Daily Fast 60° 60 min

Selectable Washing Temperatures (°C)	 (Cold Wash), 30°, 40°, 60°*
Maximum washing/drying Capacity (kg)	4.0/4.0
Selectable Spin Speed (rev/min)	 (No spin), 400, 600, 800, 1000, 1200, 1400*
Laundry Type/Description	Dirty, cotton, coloured and linen textiles. (The washing duration for loads of 2kg and under is 30 minutes).
Selectable Additional Functions**	
Selectable Drying Functions**	 30min 60min

Note: Please refer to the footnotes on page 46 for additional information on settings.

Refresh

Selectable Washing Temperatures (°C)	-
Maximum Laundry Capacity (kg)	1.0
Selectable Spin Speed (rev/min)	-
Laundry Type	This is not a washing programme. It simply breathes hot air into your laundry refreshing it.
Selectable Additional Functions**	
Selectable Drying Functions**	-

(*) Programme factory default settings.

(**) When you want to select more than one additional function, the additional functions you wish to select may not comply with each other.

(***) These are sub-programmes. Refer to page 55 for programme selection.

Do not dry towels, cotton and linens, and synthetic and synthetic mix clothes together.
For drying select the most appropriate drying programme for the clothes.

NOTE: THE PROGRAMME DURATION MAY CHANGE ACCORDING TO THE AMOUNT OF LAUNDRY, TAP WATER, AMBIENT TEMPERATURE AND SELECTED ADDITIONAL FUNCTIONS.

Temperature Selection:

It can often be difficult to know which temperature setting is best. To help with this, we have provided a table with common temperatures and their typical uses.

Temperature	Typical Use
30°C	This is the lowest wash temperature that we recommend. By using a detergent that can work at this temperature, you'll save on water and electricity bills.
40°C	This is the most common wash temperature, suitable for most everyday items.
50°C	This is suitable for most polyester/cotton mixtures and nylon.
60°C	This higher temperature is recommended for heavily soiled garments such as baby clothes or bed linen and towels.
90°C	This is suitable for white cottons and linen that show dirt.

Please be aware that the programme setting provides the default temperature for the selected programme. You can override this setting by decreasing the temperature should you wish.

Spin Selection:

You can select a Spin Speed to meet the needs of your wash. The table below suggests some typical selection speeds for common types of clothing. Please refer to the programme tables on pages 37 to 48 for available spin speeds for individual programmes.

Laundry	rpm
Cottons	1400
Delicate	600
Woollens	1400
Shirts	600
Denim	900
Dark Garments	1400

You will be pleased to learn that your Servis Washer Dryer has an in-built sensor that prevents your Washer Dryer operating with an out-of-balance load; it will make several attempts to balance the load prior to the spin cycle. If it is not possible for your Washer Dryer to balance the load, your Washer Dryer will abort the spin cycle. To reduce the likelihood of this happening, we recommend that you avoid small wash loads containing items that could become heavy through water absorption.

ADDITIONAL FUNCTIONS >

Before starting a selected programme you have the option to select an additional function:

- » Press the **↑** button to view the available additional functions for the selected programme.

Please Note: Not all additional functions are available for every programme. Please refer to the programme tables on pages 37 to 48 for further information.

- » If you do not select an additional function within 5 seconds, the information screen will return to the main programme page.
- » Once you have selected an additional function, the information screen will return to the main programme screen within approximately 5 seconds.
- Pre-Wash:** This allows you to give heavily soiled laundry a pre-wash before the main washing programme takes place.
- » Press the **↓** button to activate the pre-wash additional function. The screen shown in fig 20 will appear.

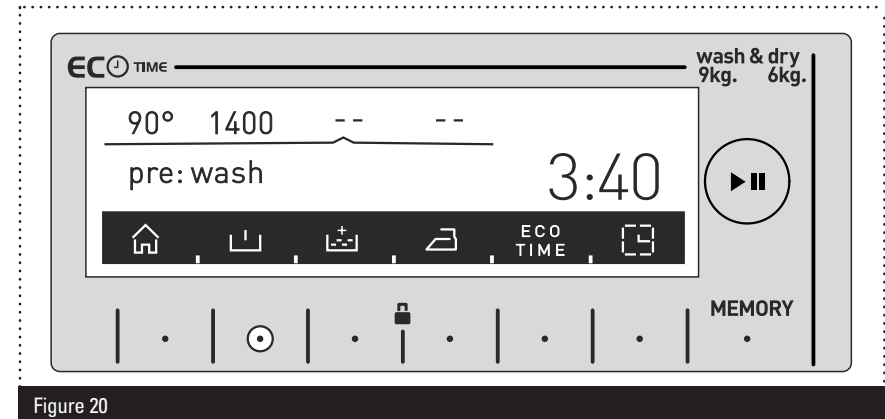



Figure 20

- Extra Rinse:** This allows you to add up to 3 additional rinses to the end of the selected wash programme.
- +1** Indicates that 1 additional rinse is made at the end of the washing programme.
- +2** Indicates that 2 additional rinses are made at the end of the washing programme.
- +3** Indicates that 3 additional rinses are made at the end of the washing programme.
- » To activate the extra-rinse function, press the **↓** button until the symbol displaying the desired number of rinses is shown on the information screen.

 **Anti-Allergic Function:** This additional rinse operation will carry out all rinsing steps in hot water. We recommend using this on laundry worn on delicate skin such as baby clothes.



» To activate this function, press the  button until the  symbol appears on the screen.

 **Easy Ironing Function:** Using this function will result in your laundry being less crinkled at the end of the selected programme.



» To activate this function, press the  button.

 **Economic Time Interval Function:** Before activating this function please ensure that you have carried out the Eco Time Setting as described on page 23.

» Press the  button to activate the Eco Time function. The  symbol will be displayed on the information screen.

» The  will be displayed on the information screen until Eco Time is switched off. To switch off Eco Time, press the  button.

» If you wish to run the selected programme while the Eco Time function is active, press the  button. The start of the programme will be delayed until the start of the Eco Time interval. The programme start time and duration will be displayed alternately on the information screen.

» If you do not wish to run the selected programme between the Eco Time hours, press the  button again. 'eco time is cancelled' will be displayed on the information screen. Your Washer Dryer will return to the main programme screen in 3 seconds. To start the programme, press the  button.

 **Delay Time/Finish Time Function:** This allows you to either delay the start time of the selected programme or specify the finish time of the programme.

» Please ensure that the current time is correctly set before using this function.

» Press the  button to access this function.

» The current time will be shown on the information screen for 3 seconds before the delay time/finish time screen is displayed (fig 21).

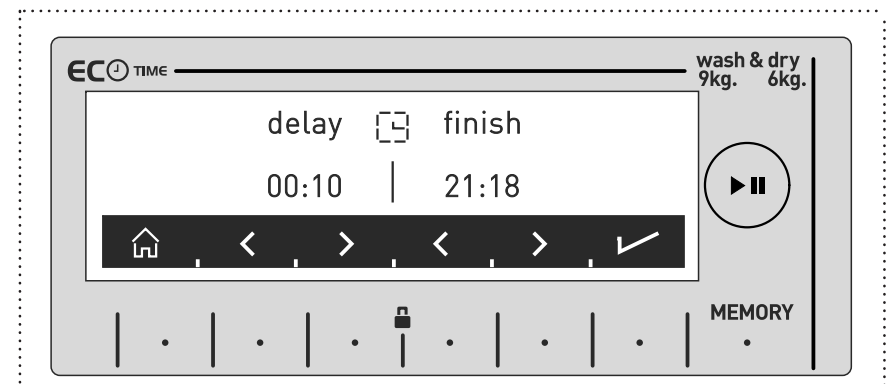



Figure 21

» You can increase or decrease the delay or finish time in 10 minute intervals by using the  or  buttons.

» Press the  button to set the delay and finish times.

Please Note: If you change the delay time, the finish time will automatically be updated. Alternatively, if you change the finish time, the delay time will automatically be updated.

Selecting a Sub-Programme

To give you further options, your Washer Dryer contains several sub-programmes. The following programmes have sub-programme options:

- » Synthetics.
- » Delicates.
- » Extras.

When you select the 'Synthetics' programme, you will have 2 sub-programme options to choose from:

- » Synthetics.
- » Curtain.
- » Select the desired option by using the < and > buttons.
- » You can activate the programme you want to select by touching the → button.

After your selection has been activated the information screen will return to the main programme screen. You can select any other required features before running the programme by using the available information screen buttons. Press the ►|| button to begin the programme.

When you select the 'Delicates' programme, you will have 2 sub-programme options to choose from:

- » Wool.
- » Silk.
- » Select the desired option by using the < and > buttons.
- » You can activate the programme you want to select by touching the → button.

After your selection has been activated the information screen will return to the main programme screen. You can select any other required features before running the programme by using the available information screen buttons. Press the ►|| button to begin the programme.

When you select the 'extras' programme, you will have 6 sub-programme options to choose from:

Cotton Dry: This programme is suitable for washing cotton laundry with a machine dryable label at a maximum drying capacity of 6 kg.

Gentle Dry: The programme is suitable for washing cotton laundry with a machine dryable label at a maximum drying capacity of 3.5 kg.

Rinse: This option is suitable for all types of laundry and provides an extra rinse to your laundry after the washing process has taken place.

Spin: This is a useful programme to use when extra spinning is required. We do not recommend this programme for delicate or wollen laundry.

Drain: This programme drains the water from your Washer Dryer.

Drum Clean: This is a drum clean programme and must be run without any laundry in the drum. When running this programme pour half a measuring cup of all-purpose detergent into compartment II of the detergent drawer.

To activate the chosen sub-programme, press the → button. You can then use the information screen buttons to select and other available settings you require. Press the ►|| button to begin the programme.

For full features and options for each sub-programme please refer to the programme tables on pages 37 to 48.

Memory Record Function

This feature allows you to store your preferred washing, drying and additional function settings so that you can easily use them again:

- » Select the settings that you wish to store and press the 'MEMORY' button.
- » 'Save as Memory' will be displayed on the information screen (fig 22).

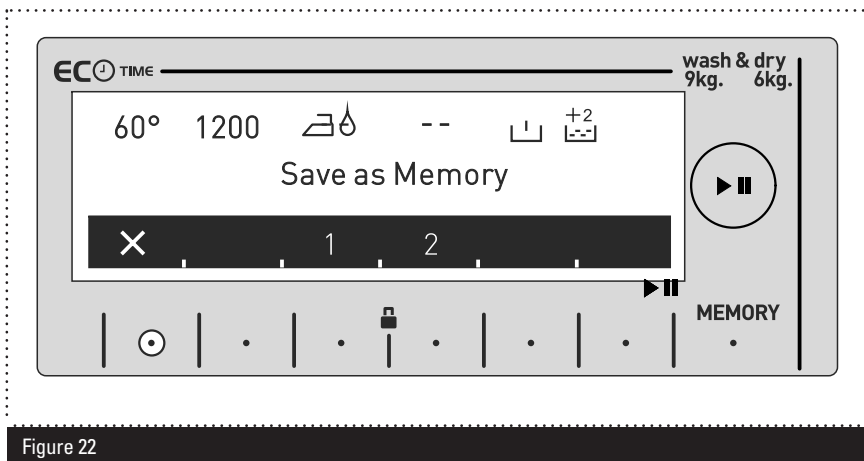

Figure 22

Please Note: You can still make changes to your chosen settings at this point. Press the ✕ button, change the settings to those that you require and press the 'MEMORY' button.

- » Once you are happy with your chosen settings, press the ✓ button.
- » After approximately 5 seconds 'Saved as memory' will be displayed on the information screen.
- » Your Washer Dryer will then return to the main programme screen.
- » To start the saved washing programme, press the ▶|| button, or select another programme.

To recall saved programme settings at a later time:

- » Turn the programme dial to 'MEMORY'.
- » Press the ▶|| button to start the programme.

You can change the setting stored in a memory location:

- » Select the settings you wish to save and press the 'MEMORY' button.
- » 'Overwrite on memory' will be displayed.
- » Press the ✓ button to store the new settings, or ✕ to cancel and return to the main programme page.
- » 'Saved as memory' will be displayed to confirm that the new settings have been stored.

Starting a Programme

To start the selected programme, press the ▶|| button. The programme you have selected will be displayed on the screen. The information screen will display the current stage of the programme such as 'washing', 'rinse', 'spin', 'drying' or 'end'. 'end' with the ◻ symbol indicates that the programme has finished and the door is unlocked. It is now safe to remove your laundry.

Pausing a Programme and Adding Extra Laundry

You can use the ▶|| button to pause or re-start the selected programme. This function is useful when you wish to add extra laundry to your Washer Dryer.

- » If the ◻ symbol is displayed on the information screen, you can open the door to add extra laundry when the programme has been paused.
- » If the ◻ symbol is displayed on the information screen, your Washer Dryer has progressed too far into the selected programme to add laundry.

Cancelling a Programme

To cancel a running programme at any time:

- » Turn the programme dial to the STOP position. Your Washer Dryer will stop the current programme.
- » Turn the programme dial to any other programme setting to drain the Washer Dryer.
- » You can now select and run a new programme.

Programme End

Your Washer Dryer will automatically stop when the programme you have selected finishes. It is safe to open the door and remove your laundry when 'end' the  symbol is displayed on the information screen.

Please Note: Your Washer Dryer has a stage that cools down your laundry at the end of its drying operation. This is to reduce the risk of you being harmed as you remove the laundry from your Washer Dryer.

Removing Your Laundry:

- 1 Wait for the selected programme to finish. This is indicated by 'end' and the  symbol of the information screen.
- 2 Pull the door handle forwards and open the door fully.
- 3 Remove your laundry; check that all items have been removed from the drum. Any items left in the drum could discolour items in the next wash or become discoloured themselves.

- 4 Check the drum and door seal for any small articles that may have become dislodged.
- 5 Leave the door open for a short time to allow the interior of your Washer Dryer to dry. Check the drum is dry and empty before closing the door.

Child Lock

Your Washer Dryer is equipped with a child lock to prevent accidental operation.

- » To activate the child lock, press the 2 buttons shown in fig 23 simultaneously for a minimum of 3 seconds.

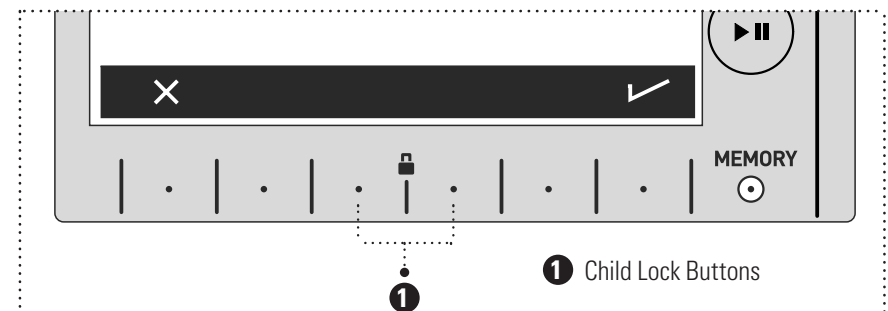



Figure 23

- » If you have successfully selected child lock  and 'keylock activated' will be displayed on the information screen.

If you press a button while the child lock is active, the button will have no effect and 'to unlock press for 3s' will be displayed on the information screen. If the child lock is active and the programme dial is switched to STOP and another programme selected, the previously selected programme will continue from the point where it was stopped. No change will take place.

- » To deactivate child lock, press the child lock buttons for a minimum of 3 seconds. 'keylock deactivated' will be displayed on the information screen. Please be aware that child lock is automatically deactivated once a programme ends.

Please Note: Child lock does not lock the pump cover or detergent drawer of your Washer Dryer.

Power Supply Failure:

If a power cut should occur while a programme is running, the programme will continue from the same point once power is restored. This will not cause any harm to your Washer Dryer or laundry. During a power cut, the door lock mechanism will release after 2 minutes. Do not open the door if there is water in your machine. If you wish to collect your laundry, drain your Washer Dryer first. Page 65 contains instructions on how to drain your machine.

GENERAL MAINTENANCE >

From time to time it may be necessary to carry out some routine maintenance of your Washer Dryer to ensure that it operates as intended. Before cleaning your Washer Dryer:

- 1 Turn your mains power supply off and remove the plug from the socket.
- 2 Turn off the cold water supply.

CAUTION: Do not use solvents, abrasive cleaners, glass cleaners or all-purpose cleaning agents to clean your Washer Dryer. They may damage the plastic surfaces and other components with the chemicals they contain.

External Casing:

- » Use a mild, non-abrasive cleaning agent, or soap and water, to clean the external casing. Wipe dry with a soft cloth.

The Drum:

- » Use a suitable stainless steel cleaning agent to clean the drum. Follow the manufacturer's advice on the cleaning agent's packaging.

Extra Cleaning:

- » Deposits may build up in your Washer Dryer when washing is mainly carried out at low temperatures. To prevent these deposits from building up, carry out a hot wash (70 °C or above) once every 6 weeks. If you have no reason to wash occasionally at this high temperature, run a high temperature cottons programme with detergent but no laundry at regular intervals.

MAINTENANCE >

Filters:

Water Inlet Filters:

Water inlet filters prevent dirt and foreign materials from entering your machine. It is recommended that these filters are cleaned when your machine is unable to receive sufficient water, although your water supply is on and the tap is open.

To clean the water inlet filters:

- 1 Unscrew the water inlet hose from the Washer Dryer by turning the hose anti-clockwise and gently pulling.
- 2 To remove the water inlet filter from the water inlet valve, use a pair of long-nosed pliers to gently pull on the plastic bar in the filter (fig 24).

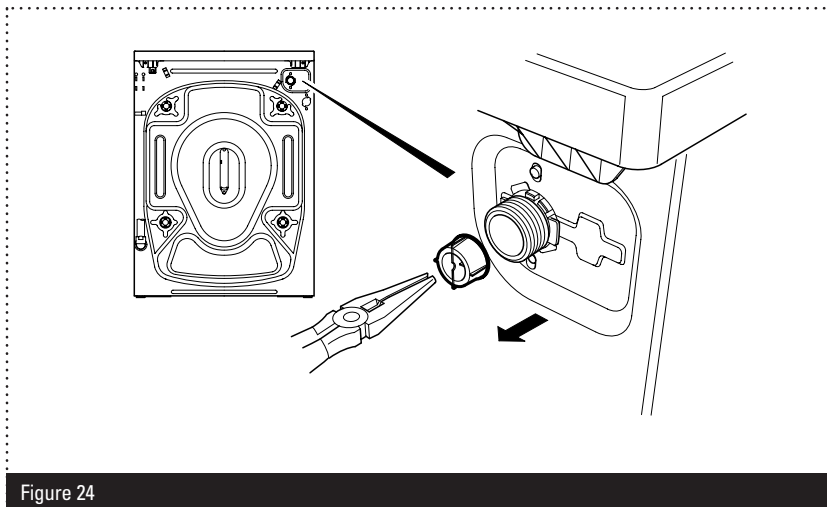

Figure 24

- 3 Clean the filter thoroughly with a soft brush, wash with soapy water and rinse thoroughly.
- 4 Re-insert the filter by gently pushing it back into place.

A second water inlet filter is located in the tap end of the water inlet hose.

To remove the second water inlet filter:

- 1 Use a pair of long-nosed pliers to gently pull on the plastic bar in the filter.
- 2 Clean the filter thoroughly with a soft brush and wash with soapy water and rinse thoroughly.
- 3 Re-insert the filter by gently pushing it back into place.

Pump Filter:

The pump filter system in your Washer Dryer prolongs the life of the pump by preventing lint from entering your machine. We recommend that you clean the pump filter every 2-3 months. The pump filter is located behind the cover on the front lower-right corner.

CAUTION: The water in the pump may be hot, wait for it cool before carrying out any cleaning or maintenance.

MAINTENANCE >

Cleaning the Pump Filter:

- 1 Before opening the filter cover, place a container under it, ready to collect any water left in the Washer Dryer.
- 2 Place the corner of the liquid detergent level plate (or a similar item such as a screwdriver) into the groove on the pump filter cover and pull forwards to remove the pump filter cover.
- 3 Gently unclip and pull out the black rubber hose. Pull off the cap and allow any water to drain into the container.
- 4 Once the water has drained, push the cap back on the end of the hose and clip the hose back into position.
- 3 Loosen the pump filter by turning anti-clockwise and remove by pulling. Wait for any water to drain into the container.

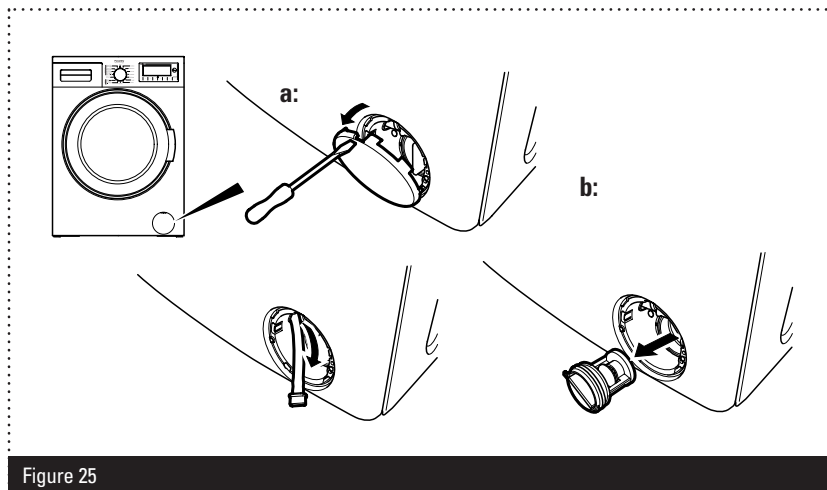

Figure 25

- 3 Remove any foreign materials from the filter with a soft brush.
- 4 Move the pump by hand to check that it rotates freely.
- 5 Clean the pump with a soft brush.

After Cleaning:

- 1 Re-fit the filter by inserting it and turning clockwise.
- 2 Close the filter cover.

DETERGENT DRAWER >

The use of detergent may cause residual build up in the detergent drawer over time. Remove the drawer at regular intervals to clean the accumulated residue. To remove the detergent drawer:

- 1 Pull the drawer forwards until it is fully extended.
- 2 Press down on the release catch (fig 26) and pull the drawer from its housing.
- 3 Clean the drawer with water and a soft brush.
- 4 If there is any residue in the drawer housing, remove with a soft brush. Take care to prevent any residue from dropping into the machine.

MAINTENANCE >

To replace the drawer:

- 5 Dry it thoroughly and slide it back into the housing.

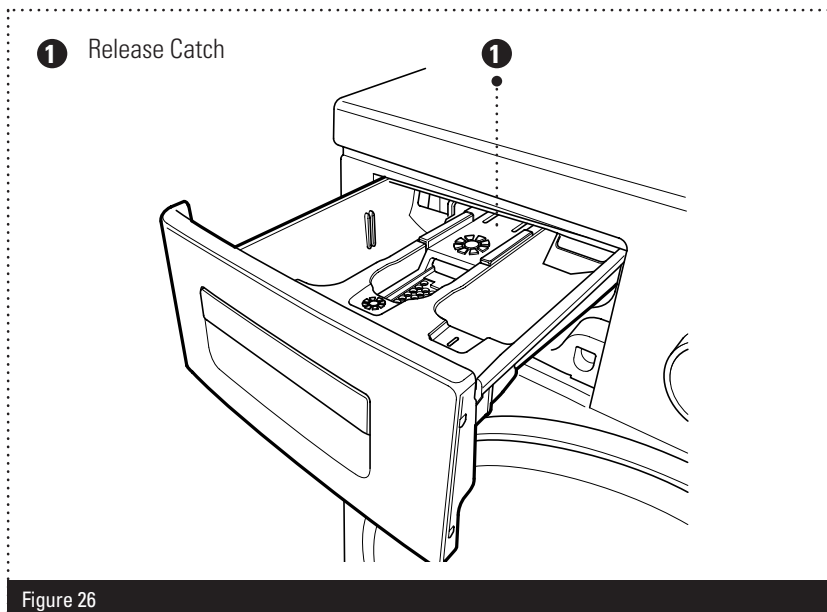

SIPHON PLUG >

The siphon plug is located in the  compartment of the detergent drawer. Remove the detergent drawer fully and unclip the  compartment cover as shown in fig 27. Remove the siphon plug by pulling upwards.

- 1 Clean the plug with a soft brush and replace, checking that it is firmly in position.
- 2 Replace the  compartment cover and slide the detergent drawer back into the housing.

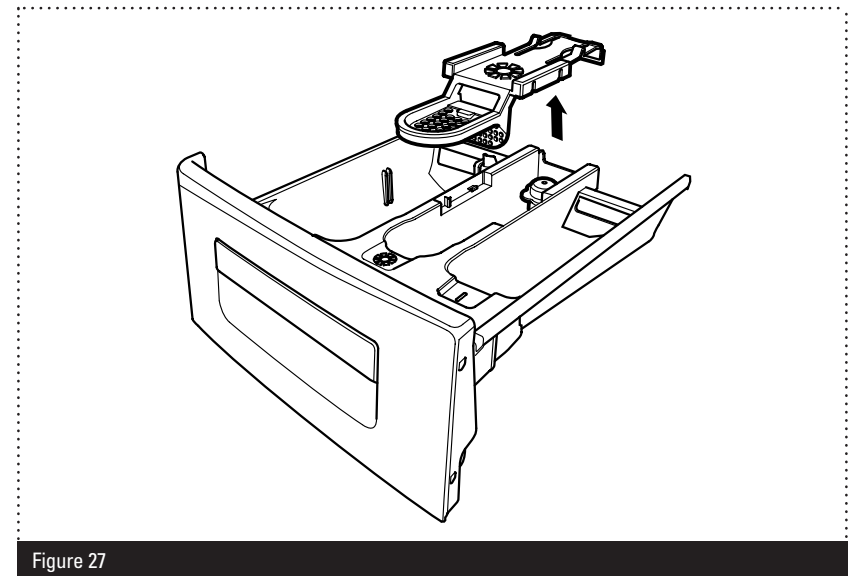

CLOTHING CARE >

GENERAL WASHING INSTRUCTIONS >

When selecting your washing programme take care to note any instructions displayed on the international washing signs in your garments and textiles.



Washing Temperature



Do not Wash

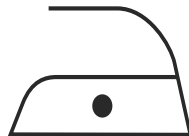

Lukewarm Iron

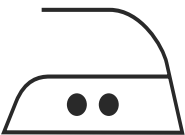

Medium Hot Iron

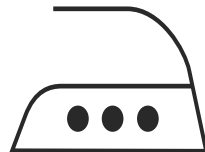

Medium Hot Iron

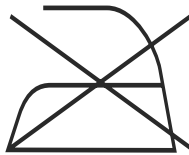

Do not Iron

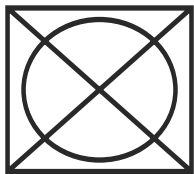

Do not Tumble Dry



Hang to Dry



Drip Dry

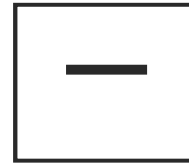

Leave on a Flat Surface

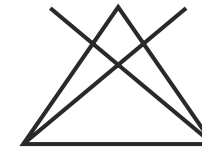

Do not Bleach

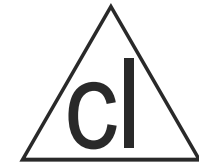

Can be Bleached in Cold Water

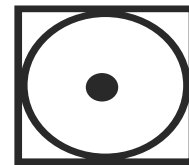

Low Temperature

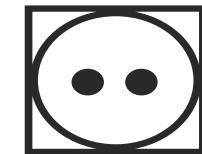

Dry in a Normal Temperature Dryer



These letters are used to instruct professional cleaners as to which type of solvent to use. Do not wash garments with these symbols in your Washer Dryer unless the label says otherwise.

CLOTHING CARE >

STAIN REMOVAL INFORMATION >

If can often be hard to know the best way to treat a stubborn stain. To help with this we've provided you with a few tips on dealing with the most common types before running your wash cycle.

Alcohol:

Wash the stain in cold water, wipe with glycerine and water and rinse with water mixed with vinegar.

Shoe Polish:

Scratch out the stain taking care not to damage the material, rub with detergent and rinse.

Tea and Coffee:

Stretch the area containing the stain and pour on hot water.

Chocolate and Cocoa:

Leave your clothes in cold water and rub with soap or detergent, then wash at a high temperature.

Tomato Paste:

Scrape away the dried pieces, leave in cold water for around 30 minutes and hand wash by rubbing with detergent.

Egg:

Scrape away the dried pieces, clean the stained area with a cold wet cloth or sponge and rub with detergent to wash.

Grease and Oil:

Rub the stain with detergent and then wash in lukewarm soapy water.

Mustard:

Apply glycerine to the stained area, rub with detergent and hand wash.

Blood:

Soak your clothes in cold water for around 30 minutes and then hand wash.

Cream, Ice Cream and Milk

Soak your clothes in cold water and rub the stained area with detergent.

Mould:

Clean the stained area as soon as possible and hand wash with detergent.

Ink:

Hold the stained area under cold water and wait until the inky water completely runs off. Rub the stain with water and diluted lemon juice, wait 5 minutes before beginning the wash cycle.

Fruit:

Stretch the stained area and pour on cold water, apply glycerine and wipe. Wait for 1-2 hours and rinse after wiping with a few drops of white vinegar.

Grass:

Rub the stained area with detergent before washing.

Oil-Based Paint:

Apply paint thinner to the stained area before it dries, then rub the area with detergent and wash.

TROUBLESHOOTING >

TROUBLESHOOTING INFORMATION >

If your Washer Dryer is not operating as expected, you may find a simple solution listed in the table below.



If your Washer Dryer has developed a fault not covered in this manual, please contact the Servis helpdesk.

Fault	Possible Cause	Solution
Your Washer Dryer does not operate.	It is switched off at the mains.	Check that your Washer Dryer is plugged in and turned on at the mains.
	The programme dial is in the off position.	Use the programme dial to select the desired programme.
	The door is not shut properly.	Check that the door 'clicks' and 'Beeps' shut.
Your Washer Dryer does not receive water.	The cold water supply tap is off.	Check that the cold water supply tap is fully turned on.
	The water fill hose is bent, twisted, kinked or trapped.	Check that there are no bends, twists or kinks and that the fill hose is not trapped.
	The door is not closed properly.	Close the door.

Fault	Possible Cause	Solution
Your Washer Dryer does not receive water.	The water inlet filters are blocked.	Clean the water inlet filters. See page 63 for detailed instructions.
Your Washer Dryer is not draining water.	The drain hose is bent, twisted, kinked or trapped.	Check the drain hose and straighten out any kinks, twists or bends.
	The pump filter is obstructed.	Clean the pump filter. See page 65 for detailed instructions.
	Your laundry is too tightly packed together in the drum.	Check that your laundry is spread out.
Your Washer Dryer is vibrating.	The feet of your machine are not correctly adjusted The transit bolts are not removed.	Adjust the feet. See page 13 for further information Remove the transit bolts. See page 11 for further information.
There is excessive foam in the detergent drawer.	Too much detergent has been used.	Press the ► button. To stop the foam, dilute one tablespoon of softener into 1/2 litre of water and pour into the detergent drawer. Press the ► button after 5-10 mins.

TROUBLESHOOTING >

Fault	Possible Cause	Solution
There is excessive foam in the detergent drawer.	The wrong detergent has been used.	Only use detergents produced for automatic Washer Dryers.
The washing result is not as expected.	Your laundry is too dirty for the programme you've selected.	Use the information on pages 37 and 48 to select the most appropriate programme.
	Not enough detergent used.	Use the amount of detergent as instructed on the packaging.
	There is too much laundry in your Washer Dryer.	Check that the maximum capacity of your Washer Dryer is not exceeded. See pages 28 and 29 for more information.
The water from the Washer Dryer is drained as soon as it is filled.	The end of the water drain hose may be too low.	Check that the drain hose is at a suitable height. See page 15 for more information.
The spin cycle does not take place.	The in-built sensor has prevented your Washer Dryer from operating with an out of balance load.	Avoid small wash loads containing items that could become heavy through water absorption.

Fault	Possible Cause	Solution
There load detection system on the screen does not work when loading the machine.	Laundry is placed in the Washer Dryer without choosing a washing or drying programme.	Remove the laundry from your Washer Dryer. Switch the programme dial to STOP, reselect the desired programme. Load the laundry in the machine and run.
 is displayed on the information screen and your Washer Dryer does not run.	There is more laundry in the machine than the maximum laundry amount for the washing and drying programme selected.	Remove laundry from your Washer Dryer until the  disappears.
Laundry remains damp after the drying operation.	The appropriate drying programme is not selected.	Select a drying programme appropriate for your laundry. Please refer to the programme tables on pages 37 to 48.
	The maximum load capacity for the selected programme might be exceeded.	

TROUBLESHOOTING >

AUTOMATIC DETECTION SYSTEM >

Your Washer Dryer is equipped with a built-in fault detection system, which is able to offer guidance should your machine not operate as expected. The most common error codes are shown below. If your machine displays a code not shown, consult the Servis helpdesk.

! PUMP

Unplug the machine.

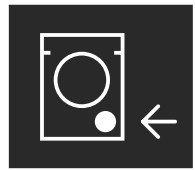

Possible Fault: Pump is damaged, pump filter is clogged or the electrical pump connection is malfunctioning.

Solution: Clean the pump filter. Contact the Servis helpdesk if the problem persists.

! OVERFLOW

Close tap.



Possible Fault: Your Washer Dryer has an excessive amount of water.

Solution: Turn off your Washer Dryer unplug it and call the Servis helpdesk.

! NO WATER

Check water supply.

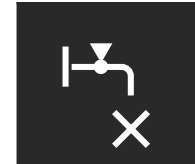

Possible Fault: No water supply or low mains water pressure

Solution: Check that the water supply is turned on, Check that the inlet hose is not kinked or twisted, Clean the inlet hose and filters

If the problem persists, unplug your Washer Dryer, turn off your water supply and contact the Servis helpdesk

! FILTER

Check filter.

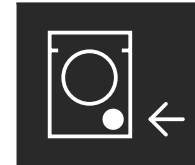

Possible Fault: The pump is damaged, the pump filter is clogged or the electrical pump connection is malfunctioning.

Solution: clean the pump filter, check the drain hose for kinks and twists. If the problem persists contact the Servis helpdesk.

TROUBLESHOOTING >

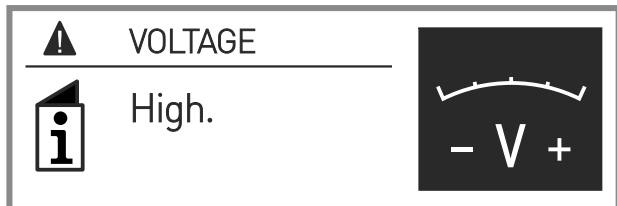
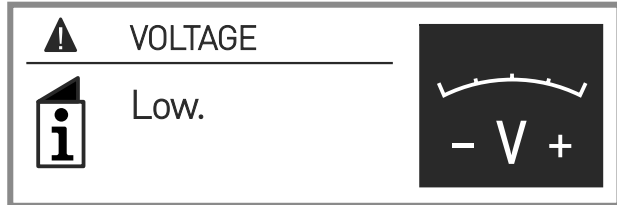

Possible Fault: The mains voltage is too high or low

Solution: Contact the Servis helpdesk

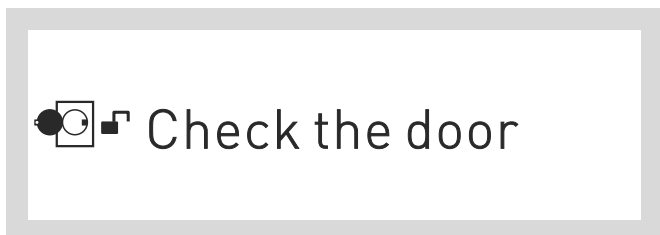

Possible Fault: The door of your Washer Dryer is left open

Solution: Close the door . If the error code is still displayed turn off your Washer Dryer, unplug it and contact the Servis helpdesk.

DISPOSAL OF YOUR OLD MACHINE >

All packaging and materials used are environmentally friendly and recyclable. Please dispose of any packaging in an environmentally friendly manner. Consult your local council for further details.

To ensure safety when disposing of an old machine, cut off the main power supply cable and break the door hinges or lock.



Please refer to the rear cover for disposal instructions.

GUARANTEE >

The Servis guarantee covers the cost of parts/labour/call out charges to repair an appliance should any covered component fail in its normal functions necessitating a repair or replacement to resume those functions.

The Servis guarantee **does not** cover:

- » Accidental damage.
- » Use in a commercial environment.
- » Incorrect or faulty installation.
- » Deliberate damage or neglect.
- » Repairs to cosmetic parts.
- » Damage caused by foreign objects or substances.
- » Claims in respect to routine inspection or maintenance.

GUARANTEE >

The Servis guarantee is not transferable.

For your Servis guarantee to be valid, you will need to retain your original purchase receipt and be able to provide it when you make a claim.

The above summary does not include all of the terms and conditions and exclusions which can be found on our website www.servis.co.uk.

KNOW YOUR RIGHTS >

Household contents insurance

Your household insurance may cover you for accidental damage, fire or theft of your product.

Data Protection Act (1988)

Please note that any information provided will be processed by us or our agents in compliance with the provisions of the Data Protection Act 1988, for the purpose of providing cover and handling claims, if any, which may necessitate providing such information to third parties.

INDEX >

A

Adding detergent	29
Additional functions.....	51
Adjusting the feet.....	13
Anti-Allergic function	53

C

Cancelling a programme.....	59
Child lock.....	60
Cleaning.....	62
Connection, drain hose.....	15
Connection, electrical.....	18
Connection, water supply.....	14
Control panel.....	19
Cupboard dry.....	33
Current time setting.....	20

D

Delay Time/Finish Time function	54
Detergent drawer.....	09
Disposal	80
Drain hose connection.....	15
Drying with Duration function.....	34
Drying your washing	33

E

Easy Ironing function	53
Economic Time Interval function.....	53
Economic Time Interval setting.....	23
Electrical connection.....	18
Extra rinse	52

F

Fabric conditioner.....	32
Factory settings	26
Feet, adjustment	13
Filters	63
First wash	27

G

General maintenance.....	62
General washing Instructions	69
Guarantee	80

H

Hanger dry	33
------------------	----

I

Installation requirements.....	11
Iron dry.....	33
Items included	02

L

Language selection setting	22
Liquid starch	32
Loading the drum	28

M

Memory Record function.....	57
-----------------------------	----

P

Pausing a programme	58
Power supply failure	61
Powerdry technology	1
Pre-wash.....	51
Programme end.....	59
Programme modes	37
Pump filter	65

R

Removal of transit bolts.....	11
Removing your laundry	59

S

Safety instructions.....	02
Screen brightness	24
Selecting a programme	32
Setting up your washer dryer.....	20
Siphon plug.....	68
Smart Touch buttons.....	20

S

Sorting your laundry.....	28
Sound adjustment.....	24
Spin selection.....	50
Stain removal information.....	71
Starting a programme.....	58
Sub programmes.....	55

T

Technical specification	10
Temperature selection.....	49
Troubleshooting information	73

W

Warranty.....	01
Water inlet filter.....	62
Water softner.....	31
Water supply connection.....	14

T: 0800 0124 382
E: info@servis.co.uk

 Visit
servis.co.uk

SERVIS
EFFICIENCY BY DESIGN



The symbol on the product or on its packaging indicates that this product may not be treated as household waste. Instead it shall be handed over to the applicable collection point for the recycling of electrical and electronic equipment. By ensuring this product is disposed of correctly, you will help prevent potential negative consequences for the environment and human health, which could otherwise be caused by inappropriate waste handling of this product. For more detailed information about recycling of this product, please contact your local city office, your household waste disposal service or the shop where you purchased the product.

Free Manuals Download Website

<http://myh66.com>

<http://usermanuals.us>

<http://www.somanuals.com>

<http://www.4manuals.cc>

<http://www.manual-lib.com>

<http://www.404manual.com>

<http://www.luxmanual.com>

<http://aubethermostatmanual.com>

Golf course search by state

<http://golfingnear.com>

Email search by domain

<http://emailbydomain.com>

Auto manuals search

<http://auto.somanuals.com>

TV manuals search

<http://tv.somanuals.com>