

Shark

OWNER'S GUIDE

SC630WC



U.S.: EURO-PRO Operating LLC
Boston, MA 02459

Canada: EURO-PRO Operating LLC
4400 Bois Franc
Ville St. Laurent, Québec H4S 1A7

1-877-304-7670

www.sharkclean.com

COPYRIGHT © EURO-PRO OPERATING LLC 2010

PRINTED IN CHINA REV. 100119

Illustrations may differ with actual product.

IMPORTANT SAFETY INSTRUCTIONS SAVE THESE INSTRUCTIONS

For Household Use Only

WHEN USING YOUR SHARK® PORTABLE STEAM POCKET®, BASIC SAFETY PRECAUTIONS SHOULD ALWAYS BE FOLLOWED, INCLUDING THE FOLLOWING:

READ ALL INSTRUCTIONS BEFORE USING YOUR PORTABLE STEAM POCKET®.

DANGER OF SCALDING

Please use caution when using the steam bottle directly or with the hose and tool attachments and cleaning pockets. The steam emitted is very hot.

POLARIZED PLUG:

This appliance has a polarized plug (one blade is wider than the other). As a safety feature, this plug will fit into a polarized outlet only one way. If the plug does not fit fully into the outlet, reverse the plug. If it still does not fit, contact a qualified electrician. **Do not attempt to defeat this safety feature.**

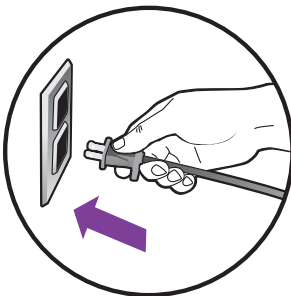

- USE THE SYSTEM ONLY FOR ITS INTENDED USE AS DESCRIBED IN THIS MANUAL.**
- ONLY USE WATER.** To extend the life of your Portable Steam Pocket®, we recommend using distilled water. If you live in an area with hard tap water, we recommend using distilled water.
- DO NOT** add cleaning solutions, scented perfumes, oils, or any other chemicals to the water used in this appliance as this may damage the unit or make it unsafe for use. Use of any substances other than manufacturer's recommended accessories will automatically void your warranty.
- DO NOT** use outdoors.
- DO NOT** leave the appliance unattended when plugged in.
- Always unplug the power cord from the electrical outlet when not in use, when filling the water tank and before servicing.
- DO NOT** allow to be used by children. Close attention is necessary when used by or near children, pets or plants.
- DO NOT** put any objects into openings or operate with any opening blocked
- DO NOT** use on leather, wax polished furniture or floors, painted surfaces, synthetic fabrics, velvet, or other delicate, steam sensitive materials.
- Carefully remove the steam cleaning pocket immediately after you have unplugged and allowed the portable steam pocket® to cool.
- Always unplug and allow the portable steam pocket® to cool before removing cleaning fabric or changing cleaning tools and hose.
- NEVER** store the appliance with a damp/wet cleaning pocket attached. If left in a single spot for a period of time with a damp/wet pocket attached, the moisture may cause surface damage.
- When cleaning the portable steam pocket®, unplug the power cord and clean with a dry or damp cloth. Do not pour water or use alcohol, benzene or paint thinner on the unit.
- NEVER** use the cleaning pocket wedge or cylinder tools without the cleaning pocket fabric attached.
- To protect against a risk of fire, electric shock, or injury:
 - To avoid circuit overload, **DO NOT** operate another appliance on the same socket (circuit as the portable steam pocket® cleaning system).
 - DO NOT** immerse any part of the system in water or other liquids.
 - DO NOT** pull power cord to disconnect from outlet; instead, grasp plug and pull to disconnect.
 - DO NOT** use extension cords or outlets with inadequate current carrying capacity.
 - DO NOT** operate the system with a damaged cord or plug, or if the appliance or any other part of the system has been dropped or damaged.
 - DO NOT** disassemble or attempt to repair the Steam Bottle. Return the system to **EURO-PRO Operating LLC** for examination and repair. Incorrect reassembly or repair can cause a risk of electrical shock or injury to persons when the Steam Bottle is used.
- DO NOT** handle plug or portable steam pocket® with wet hands or operate without shoes.
- DO NOT** pull or carry by power cord, power cord as a handle, close a door on the power cord, or pull the power cord around sharp corners or edges.
- DO NOT** allow power cord to touch hot surfaces.
- ALWAYS** disconnect system from electrical outlet when filling with water or emptying and when not in use.
- NEVER** attempt to fill this unit under a water faucet. Always use the filling flask that is provided.
- NEVER** turn the appliance over or on its side when in use.
- NEVER** aim or direct steam towards people, animals, or plants. The steam is very hot and can cause burns. Burns can occur from touching hot metal parts, hot water, steam or steam pockets.
- DO NOT** operate the steam cleaner while under the influence of drugs, alcohol or medications.
- DO NOT** operate in the presence of explosive and/or flammable fumes.
- Store your appliance indoors in a cool, dry area.
- Keep your work area well lit.
- Let the system cool completely before putting away. Wrap cord loosely around system when storing, using the cord clip to secure.
- Keep out of the reach of children.**



TOLL FREE: 1-877-304-7670

www.sharkclean.com

Quick Start

Your Portable Steam Pocket® is designed to clean surfaces that will withstand high heat and moisture. Do not use on unsealed wood surfaces (especially wooden antique furniture), unglazed ceramic tile, painted surfaces or surfaces that have been treated with wax, oils, varnishes, or shellac. The sheen may be removed by the heat, steam, and friction of the cleaning tools. Lacquer and polyurethane coatings provide a hard durable protective finish that withstands moisture but it is always recommended to test an isolated area of the surface to be cleaned before proceeding. We also recommend you check the use and care instructions from the surface manufacturer.

When cleaning finished wood surfaces, use broad, continuous cleaning strokes. To prevent surface damage, avoid focusing steam or allowing the cleaning tools to sit in one spot for any amount of time.

When assembling your Portable Steam Pocket®, there may be a little water in the water tank. This is because we test all our portable steam pocket cleaning systems 100% before you buy them, so you get a quality Shark Steam product.

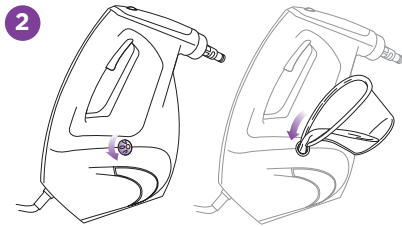

ASSEMBLY

- 1 Safely remove contents of the Portable Steam Pocket® Cleaning System and lay them out on a flat surface to see that you have all the components to complete the assembly (Refer to page 2).

FILL

- 2 Turn the water tank cap counter-clockwise and remove to fill, using the filling flask provided. Be careful not to overfill. Replace the cap by turning clockwise. The water tank does not have to be completely full for the steam bottle to generate steam. Steam will stop when the water tank is empty. You can refill at any time.

DIRECT SPRAY STEAM BOTTLE USE

- 3 Attach the steam bottle nozzle. Aligning the arrow located on the steam bottle nozzle with the un-lock symbol located on the nozzle connector. Press in and turn clockwise to secure into place. The arrow on the nozzle will align with the lock symbol.

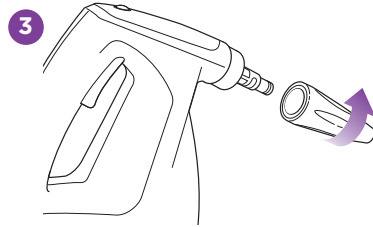

HOSE & CLEANING TOOL ATTACHMENT USE

- 4 Attach the hose connector. Aligning the arrow located on the hose connector with the un-lock symbol located on the nozzle connector. Press in and turn clockwise to secure into place. The arrow on the hose connector will align with the lock symbol.
- 5 Select the desired cleaning tool for use. Follow the cleaning tool sub assembly Instructions for the selected tool.
- 6 Attach the cleaning tool by inserting the hose stem into the handle of the cleaning tool. **Press in and turn clockwise at the same time to secure and press in and turn counter clockwise to release.** Check for proper connection by turning the handle counter-clockwise a few turns. The handle should remain connected.

(Note for reference: This connection method is the same design used with most over the counter prescription bottles). The design of this connection is to prevent the hose from twisting and kinking during use.

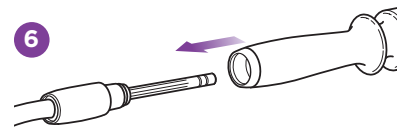
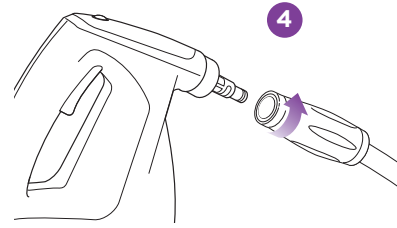

WEDGE CLEANING TOOL ASSEMBLY

- 7 Slide the wedge shaped cleaning pocket over the wedge cleaning tool frame until it is completely on.
- 8 Close the cinch by pulling on the elastic band and sliding the locking bean to tighten.

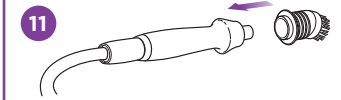
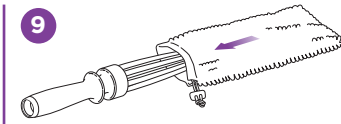
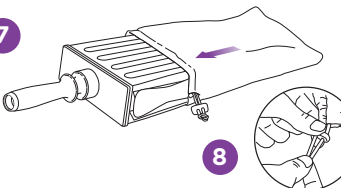

DETAIL CLEANING TOOL ASSEMBLY

- 11 Press fit the **scrubbing detail brush** onto the detail cleaning tool handle.

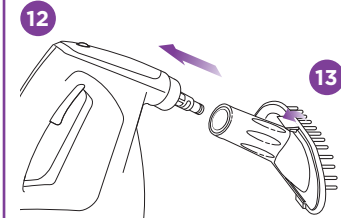

GARMENT STEAMER ASSEMBLY

- 12 Press fit the garment steamer onto the bottle nozzle.
- 13 Stretch the garment steamer bonnet over the garment steamer diffuser. Attach the garment brush onto the garment steamer diffuser by aligning the bottom of the diffuser with the back of the garment brush attachment. Gently push the top of the garment brush up into place until the attachment snaps into place.



TOLL FREE: 1-877-304-7670

www.sharkclean.com

Contents

Thank you for
purchasing
the Shark®
Portable
Steam Pocket®
Cleaning
System.

GETTING STARTED.....	2
USING YOUR PORTABLE STEAM POCKET®	4
CARE OF YOUR PORTABLE STEAM POCKET®	9
SUGGESTED USES	10
TROUBLESHOOTING GUIDE.....	12
REPLACEMENT PARTS.....	16
WARRANTY AND REGISTRATION.....	17

TECHNICAL SPECIFICATIONS

Voltage: 120V., 60Hz.

Power: 1550 Watts

Water Capacity: 450 ml (15 fl. oz.)



TOLL FREE: 1-877-304-7670

Getting Started

Your Portable Steam Pocket® is designed to clean surfaces that will withstand high heat and moisture. Do not use on unsealed wood surfaces (especially wooden antique furniture), unglazed ceramic tile, painted surfaces or surfaces that have been treated with wax, oils, varnishes, or shellac. The sheen may be removed by the heat, steam, and friction of the cleaning tools. Lacquer and polyurethane coatings provide a hard durable protective finish that withstands moisture but it is always recommended to test an isolated area of the surface to be cleaned before proceeding.

We also recommend you check the use and care instructions from the surface manufacturer.

When cleaning finished wood surfaces, use broad, continuous cleaning strokes. To prevent surface damage, avoid focusing steam or allowing the cleaning tools to sit in one spot for any amount of time.

When assembling your Portable Steam Pocket®, there may be a little water in the water tank. This is because we test all our portable steam pocket cleaning systems 100% before you buy them, so you get a quality Shark Steam product.

FIRST THINGS FIRST, YOU NEED TO KNOW WHAT'S IN THE BOX YOU JUST OPENED:

- a Steam Bottle
- b Extension Hose
- c Wedge Cleaning Tool
- d Cylinder Cleaning Tool
- e Detail Cleaning Handle
- f 2 Detail Brush Accessories
- g Garment Steamer Diffuser
- h Garment Brush Attachment
- i Garment Steamer Bonnet
- j Filling Flask
- k Direct Steam Nozzle
- l 2 All-Purpose Wedge Cleaning Pockets
- m 2 All-Purpose Cylinder Cleaning Pockets
- n Steam Duster Cylinder Cleaning Pocket
- o Scrubbing Wedge Pocket
- p Squeegee Wedge Pocket
- q Nozzle Cleaner
- r Tote Bag (not shown)

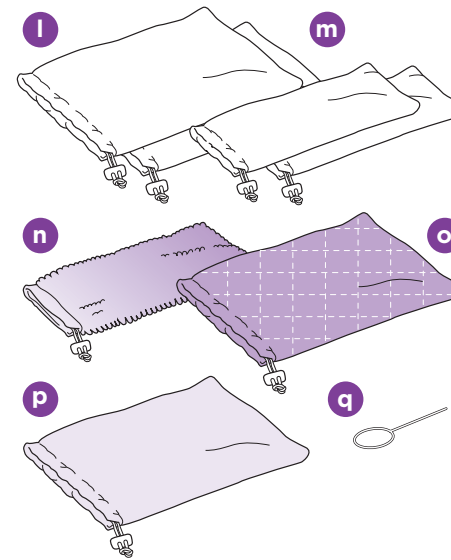
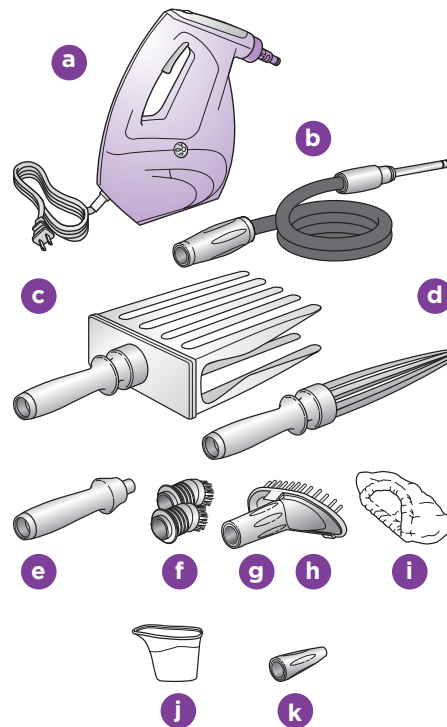

ASSEMBLY & USE INSTRUCTIONS

- 1 Safely remove contents of the Portable Steam Pocket® Cleaning System and lay them out on a flat surface to see that you have all the components to complete the assembly.
- 2 READ ALL INSTRUCTIONS BEFORE USING YOUR PORTABLE STEAM POCKET®.

! IMPORTANT: Always make sure the steam bottle is UNPLUGGED from the electrical outlet when not in use. Never fill the water reservoir when the unit is plugged in.

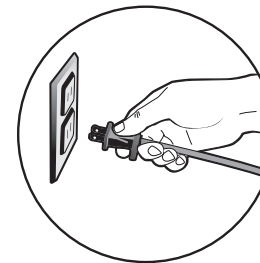

- 3 Only use water. To extend the life of your Portable Steam Pocket®, we recommend using distilled water. If you live in an area with hard tap water, we recommend using distilled water.
- 4 Do not add cleaning solutions, scented perfumes, oils, or any other chemicals to the water used in this appliance as this may damage the unit or make it unsafe for use. Use of any substances other than manufacturer's recommended accessories will automatically void your warranty.

FILLING AND REFILLING THE WATER TANK

- 1 Never fill the steam bottle while plugged into an electrical outlet.
- 2 Disconnect the power cord before filling the water tank.
- 3 Turn the water tank cap counter clockwise and remove to fill, using the filling flask provided. Be careful not to overfill. Replace the cap by turning clockwise.

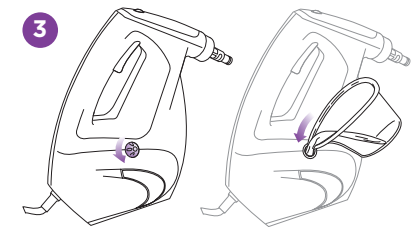

DIRECT SPRAY STEAM BOTTLE USE

Cleaning Tip: Direct steam spray for cleaning hard to reach nooks & crannies and stubborn sticky messes where focused steam power may be needed. Direct steam spray can loosen and dislodge compact dirt often found in corners and tight places where traditional methods and cleaning tools tend to push dirt into, making it difficult to reach and clean. Spray direct steam and wipe clean with a cleaning cloth.

CAUTION: Direct steam spray temperature is extremely hot closest to the nozzle and can damage surfaces if held directly focusing in one spot too long. Be sure to constantly move and adjust the steam spray to avoid causing damage.

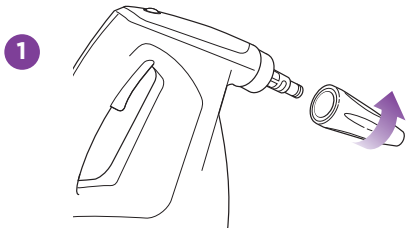

- 1 Attach the Steam Bottle Nozzle. Aligning the arrow located on the Steam Bottle Nozzle with the Un-Lock symbol located on the Nozzle Connector. Press in and turn clockwise to secure into place. The arrow on the nozzle will align with the Lock symbol.
- 2 To remove the Steam Bottle Nozzle, turn counter-clockwise to unlock and remove.

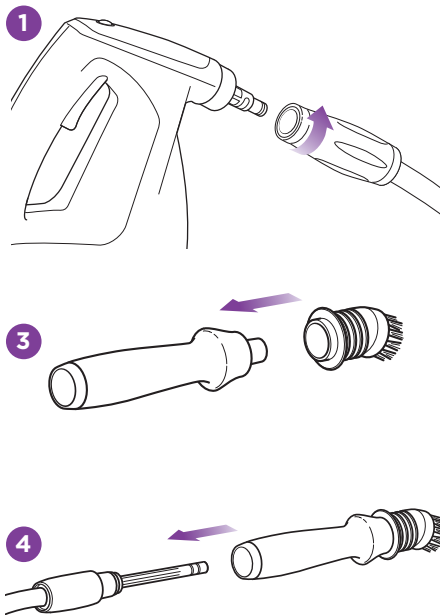

- 1 Attach the hose connector. Aligning the arrow located on the hose connector with the un-lock symbol located on the nozzle connector. Press in and turn clockwise to secure into place. The arrow on the hose connector will align with the lock symbol.
- 2 To remove the hose, press in and turn the hose connector counter-clockwise to unlock and remove.
- 3 Select the desired cleaning tool for use. Follow the cleaning tool sub assembly instructions for the selected tool.
- 4 Attach the cleaning tool by inserting the hose stem into the handle of the cleaning tool. **Press in and turn clockwise at the same time**

to secure and press in and turn counter clockwise to release. Check for proper connection by turning the handle counter-clockwise a few turns. The handle should remain connected. (Note for reference: This connection method is the same design used with most over the counter prescription bottles). The design of this connection is to prevent the hose from twisting and kinking during use.

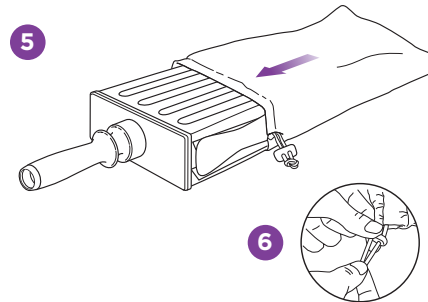

WEDGE CLEANING TOOL ASSEMBLY

- 5 Slide the wedge shaped cleaning pocket over the wedge cleaning tool frame until it is completely on.
- 6 Secure the cleaning pocket onto the frame. Close the cinch by pulling on the elastic band and sliding the locking bean to tighten.

Cleaning Tip: The wedge cleaning pocket was designed for cleaning a variety of surfaces and is exceptional on those that are large and flat, both horizontal and vertical. Broad cleaning sides and super absorbent microfiber fabrics loosen, lift, and lock in dirt and grime while sanitizing at the same time.

Cleaning Tip: The wedge tip and squared edges reach into tight areas often missed or difficult to reach with traditional cleaning methods. The Wedge sides concave to wrap around sink and faucet fixtures, door knobs, and other small curved surfaces leaving them clean all around. Multiple sides provide more surface cleaning area and allow one to clean with one side and finish with the other for a "NOW YOU KNOW THAT'S CLEAN" performance. Surface examples for use are countertops, tabletops, cabinets, walls, floor spot cleaning, bathroom fixtures and more.

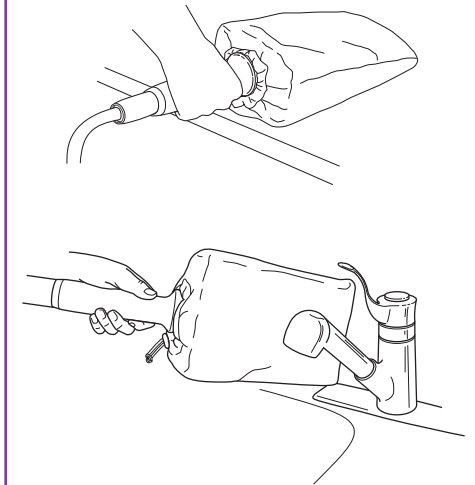

CAUTION: It is recommended that you allow the cleaning pockets to cool off before removing them from the wedge or cylinder tools to avoid possible scalding injury.

CYLINDER CLEANING TOOL ASSEMBLY

- 1 Squeeze "chopsticks" together and slide the cylinder shaped cleaning pocket over the cylinder cleaning tool frame until it is completely on.
- 2 Secure the cleaning pocket onto the frame. Close the cinch by pulling on the elastic band and sliding the locking bean to tighten.

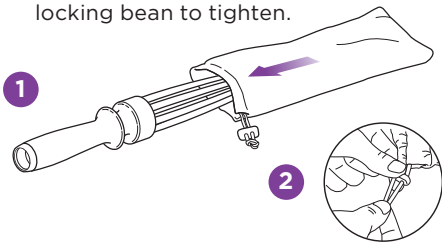

Cleaning Tip: The thin cylinder shape provides controlled cleaning and reaches into narrow areas, around curved and contoured surfaces for steam dusting and fine cleaning activities. Specialized dusting cleaning pockets provide gentle cleaning of surfaces, objects, and furniture while reaching into crevices and corners. It is a great cleaning tool for in and around window sills, door jams and frames, exhaust and intake vents, banisters, railings, spindles, furniture, seating, patio furniture, and more.

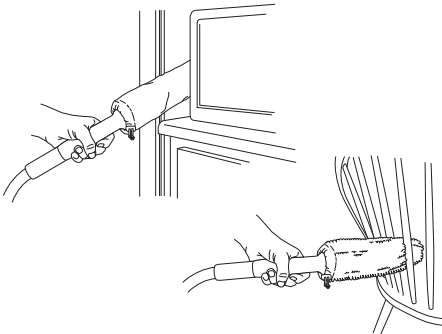

DETAIL SCRUBBING BRUSH ATTACHMENT

- 1 Press fit the detail scrubbing brush onto the detail cleaning handle.

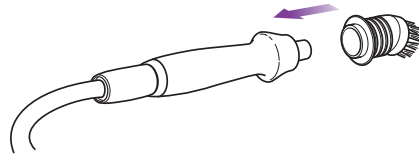

Cleaning Tip: The scrubbing brush attachment is great for hard to reach areas and for breaking up heavily soiled and dried on messes. Allow plenty of time for steam heat and moisture to penetrate the surface as it dislodges the mess for wiping. It can be especially useful in the bathroom and shower area loosening scum build-up on tile and grout. Select either of the cleaning pocket tools to clean, sanitize, and wipe up excess moisture and residue.

NOTE: The detail scrubbing brush is most effective when applying light pressure. Let the super heated steam and the bristle tips do the work for you. The sides of the bristles are not effective for scrubbing. If you apply too much force, you will bend and deform the bristles.

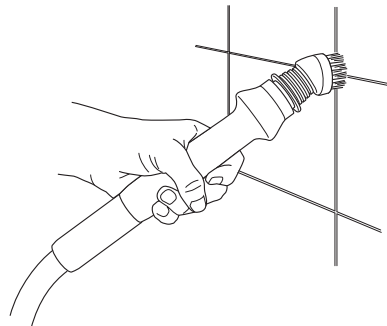

GARMENT STEAMER ATTACHMENT

CAUTION: Always determine color fastness of any fabric, especially with reds or blues. Taking a clean, moist, warm towel and gently rubbing a small area on the fabric that is out of sight and out of the way as possible. If color bleeds onto the towel, you may need to have the piece professionally cleaned.

- 1 Press fit the garment steamer onto the bottle nozzle
- 2 For garment steaming, stretch the garment steamer bonnet over the garment steamer diffuser
- 3 For garment brush, attach directly onto the garment steamer diffuser by aligning the bottom of the diffuser with the back of the garment brush attachment. Gently push the top of the garment brush up into place over the bonnet until the attachment snaps into place.

Note: It is recommended that the bonnet be used at all times to assure a dry steam and prevent condensation.

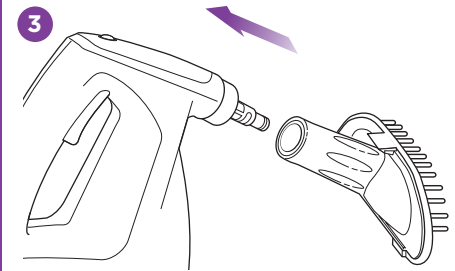

Tip: For freshening upholstery and removing wrinkles from clothing, fabrics, and drapes.

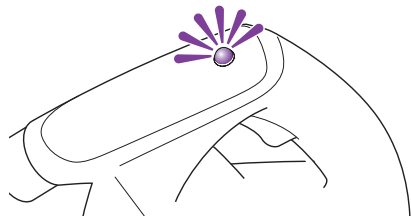

IMPORTANT: Once plugged in, the Blue LED will illuminate, and your Portable Steam Pocket® Cleaning System will be ready to use within 30 seconds.

WARNING: Your portable steam pocket® is designed to clean surfaces that will withstand high heat and moisture. Do not use on unsealed wood surfaces (especially wooden antique furniture), unglazed ceramic tile, or surfaces that have been treated with wax, oils, varnishes, or shellac. The sheen may be removed by the heat, steam, and friction of the cleaning tools. Lacquer and polyurethane coatings provide a hard durable protective finish that withstands moisture but it is always recommended to test an isolated area of the surface to be cleaned before proceeding. We also recommend you check the use and care instructions from the surface manufacturer.

NOTE: Make sure surfaces are free of crumbs and debris before using the portable steam pocket®. Large objects may not be picked up by the steam pocket and will only be pushed around.

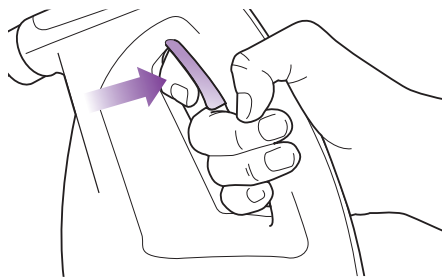

GENERATING STEAM

- 1 Plug the unit in and wait about 30 to 45 seconds then press and hold the steam trigger to activate the pump. You will immediately hear steam generating and begin to see visible results either from the nozzle or the attached cleaning tool. It is recommended that you wait at least 30 seconds before pulling the trigger as this will minimize water spitting.
- 2 Once you release the steam trigger, the pump will stop delivering water to the boiler and the steam will reduce to a stop when the boiler becomes empty.
- 3 For wedge and cylinder cleaning pockets, allow the bottle to generate enough steam to activate the cleaning fabric. Once you see visible steam emitting through the fabric, your cleaning pocket is ready to use. Some messes, particularly those that are sticky may require more moisture, so allow more steam to generate and exhaust from the cleaning pocket before cleaning.

CAUTION: Steam is hot and can cause burns, so please use with caution.

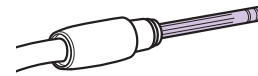

WARNING: The hose stem becomes very hot during operation and can cause burns. Do not operate the Portable Steam Pocket® without the proper cleaning tools attached securely as instructed.

Caution: This appliance must be unplugged from electrical outlet and allowed to cool down before storage or cleaning.

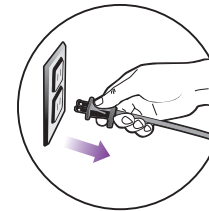

STORAGE

- 1 Let the appliance cool down before cleaning or storing
- 2 Empty the water tank after each use
- 3 Store in a cool dry location

CLEANING THE STEAM BOTTLE

- 1 A periodic rinse of your steam cleaner will help free it from normal water deposits. This is recommended every 10-15 fillings to free up any scale deposit. Fill the reservoir with water and secure the cap. Shake vigorously for approximately 10-15 times and remove the cap to empty the reservoir.

CLEANING THE NOZZLES

- 1 Your Portable Steam Pocket® should not normally require cleaning, however, should you notice a decrease in the steam output, it may be necessary to remove mineral deposits built up around the nozzles.
- 2 Unplug the cleaner from the electrical outlet
- 3 Use the provided nozzle cleaner or a small diameter stiff metal wire, such as a straightened metal paperclip, and carefully insert the end of the wire into the nozzle orifice. See illustrations below.
- 4 Move the wire back and forth several times to remove any deposits.
- 5 Plug in the appliance to the power outlet and test to note steam output.

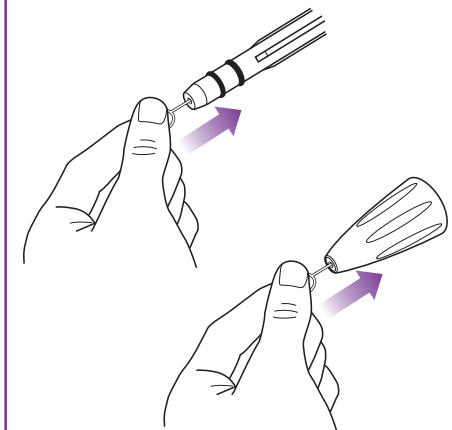

Cleaning tip: To prevent clogging, it is recommended that you periodically clean the Direct Steam Nozzle and the extension hose stem with the cleaning tool provided or a paper clip.

Suggested Uses

English

KITCHEN CLEANING

Clean and sanitize daily messes in your sinks, microwaves, refrigerators, stove tops, food prep areas like countertops and cutting boards, and trash cans.



BATHROOM CLEANING

Your portable steam cleaner can reduce common household bacteria and odors from all corners and areas of your bathroom, from toilets, sinks, tubs, showers, and floors. Wiping grime out of those impossible to reach spots without harsh chemicals or perfumy residue. Clean all surfaces including glass, mirrors and ceramic tiles.



PROBLEM	POSSIBLE REASONS	SOLUTIONS
There is no steam	The Steam Bottle is not plugged in.	Verify that the Blue light is on and the product is plugged in correctly into a working outlet.
	There is not enough water in the unit.	Fill the steam bottle tank.
There is not enough steam	Mineral build-up may be clogging the nozzle.	Using the nozzle cleaner, carefully clean the nozzle to remove debris.
	Water level may be low.	Fill the steam bottle tank.
The cleaning pockets are streaking or leaving dirt behind	The microfiber fabrics may be dirty and need to be replaced or washed.	Use the other sides, if clean. Replace with a clean cleaning pocket.
	The microfiber fabric may be worn.	Replace as needed.
The cleaning tool handles keep falling off the hose	The connection may not be secure.	Check the connection, making sure you are pressing in and turning at the same time.

Replacement Parts

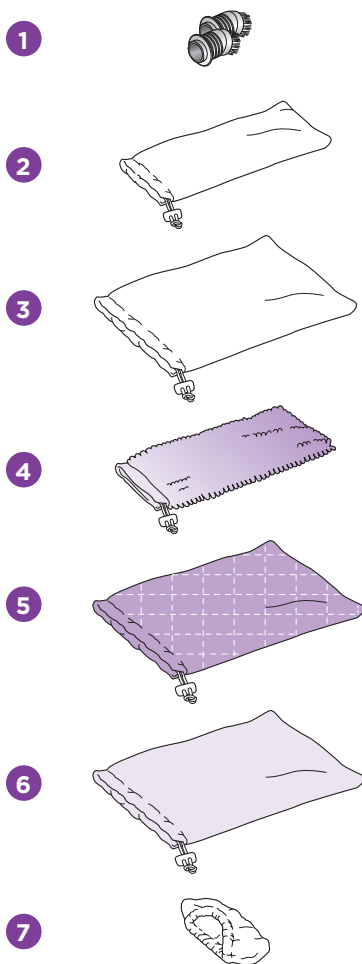

ORDERING REPLACEMENT PARTS

To order additional parts and accessories, feel free to contact us at www.sharkclean.com or call 1-877-304-7670.

PART	PART NO.
1 2 Detail Scubbing Brushes	1036SO
2 All-Purpose Cylinder Cleaning Pocket	P105W
3 All-Purpose Wedge Cleaning Pocket	P106W
4 Steam Duster Cylinder Cleaning Pocket	P107W

PART	PART NO.
5 Scrubbing Wedge Cleaning Pocket	P109W
6 Squeegee Wedge Cleaning Pocket	P108W
7 Garment Steamer Bonnet	XBON637

MODEL SC630WC

English

ONE (1) YEAR LIMITED WARRANTY

EURO-PRO Operating LLC warrants this product to be free from defects in material and workmanship for a period of one (1) year from the date of the original purchase, when utilized for normal household use, subject to the following conditions, exclusions and exceptions.

If your appliance fails to operate properly while in use under normal household conditions within the warranty period, return the complete appliance and accessories, freight prepaid. For Customer Service support, call 1 (877) 304-7670 or visit our website www.sharkclean.com.

If the appliance is found to be defective in material or workmanship, **EURO-PRO Operating LLC** will repair or replace it free of charge. Proof of purchase date and \$ 9.95 to cover the cost of return shipping and handling must be included. *

The liability of **EURO-PRO Operating LLC** is limited solely to the cost of the repair or replacement of the unit at our option. This warranty does not cover normal wear of parts and does not apply to any unit that has been tampered with or used for commercial purposes. This limited warranty does not cover damage caused by misuse, abuse, negligent handling or damage due to faulty packaging or mishandling in transit. This warranty does not cover damage or defects caused by or resulting from damages from shipping or repairs, service or alterations to the product or any of its parts, which have been performed by a repair person not authorized by **EURO-PRO Operating LLC**.

This warranty is extended to the original purchaser of the unit and excludes all other legal and/or conventional warranties. The responsibility of **EURO-PRO Operating LLC** if any, is limited to the specific obligations expressly assumed by it under the terms of the limited warranty. **In no event is EURO-PRO Operating LLC** liable for incidental or consequential damages of any nature whatsoever. Some states/provinces do not permit the exclusion or limitation of incidental or consequential damages, so the above may not apply to you.

This warranty gives you specific legal rights, and you may also have other rights which vary from state to state or province to province.

***Important: Carefully pack item to avoid damage in shipping. Be sure to include proof of purchase date and to attach tag to item before packing with your name, complete address and phone number with a note giving purchase information, model number and what you believe is the problem with item. We recommend you insure the package (as damage in shipping is not covered by your warranty). Mark the outside of your package "ATTENTION CUSTOMER SERVICE". We are constantly striving to improve our products, therefore the specifications contained herein are subject to change without notice.**

OWNERSHIP REGISTRATION CARD FOR CANADIAN CONSUMERS ONLY

Please complete and return within ten (10) days of purchase. The registration will enable us to contact you in the event a product defect is discovered. By returning this card you acknowledge to have read and understood the instructions for use, and warnings set forth in the accompanying instructions.

RETURN TO: **EURO-PRO Operating LLC**, 4400 Bois Franc, St. Laurent, Quebec H4S 1A7

PURCHASER:

ADDRESS:

DATE OF PURCHASE: MODEL: **SC630WC**

NAME AND ADDRESS OF STORE:



Free Manuals Download Website

<http://myh66.com>

<http://usermanuals.us>

<http://www.somanuals.com>

<http://www.4manuals.cc>

<http://www.manual-lib.com>

<http://www.404manual.com>

<http://www.luxmanual.com>

<http://aubethermostatmanual.com>

Golf course search by state

<http://golfingnear.com>

Email search by domain

<http://emailbydomain.com>

Auto manuals search

<http://auto.somanuals.com>

TV manuals search

<http://tv.somanuals.com>