



## Retractable Cord Stick Vac

### OWNER'S MANUAL

Model EP604

120V., 60Hz., 8.5 Amps.

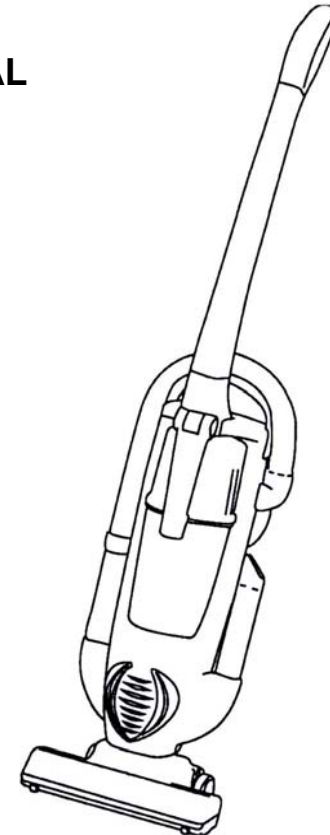

### **EURO-PRO Operating LLC**

U.S.: 94 Main Mill Street, Door 16  
Plattsburgh, NY 12901

Canada: 4400 Bois-Franc  
St-Laurent, QC H4S 1A7

Tel. :1 (800) 798-7398  
[www.sharkvac.com](http://www.sharkvac.com)

**EURO-PRO** X





## ONE (1) YEAR LIMITED WARRANTY

**EURO-PRO Operating LLC** warrants this product to be free from defects in material and workmanship for a period of one (1) year from the date of the original purchase. This warranty applies only to normal domestic household use.

Should your appliance fail to operate properly while in use under normal household conditions within the one (1) year warranty period, return the complete appliance and accessories, freight prepaid to **EURO-PRO Operating LLC** at the address given below. If the appliance is found to be defective in material or workmanship, **EURO-PRO Operating LLC** will repair or replace it free of charge. Proof of purchase date and \$ 12.95 to cover the cost of return shipping and handling must be included. \*

**U.S.:** **EURO-PRO Operating LLC**, 94 Main Mill Street, Door 16, Plattsburgh, NY 12901

**Canada:** **EURO-PRO Operating LLC**, 4400 Bois Franc, St. Laurent, QC H4S 1A7

Non-durable parts including, without limitation, accessories, filters and electrical parts which normally require replacement are specifically excluded from warranty.

The liability of **EURO-PRO Operating LLC** is limited solely to the cost of the repair or replacement of the unit at our option. This warranty does not cover normal wear of parts and does not apply to any unit that has been tampered with or used for commercial purposes. This limited warranty does not cover damage caused by misuse, abuse, negligent handling or damage due to faulty packaging or mishandling in transit. This warranty does not cover damage or defects caused by or resulting from damages from shipping or repairs, service or alterations to the product or any of its parts, which have been performed by a repair person not authorized by **EURO-PRO Operating LLC**.

This warranty is extended to the original purchaser of the unit and excludes all other legal and/or conventional warranties. The responsibility of **EURO-PRO Operating LLC** if any, is limited to the specific obligations expressly assumed by it under the terms of the limited warranty. **In no event is EURO-PRO Operating LLC** liable for incidental or consequential damages of any nature whatsoever. Some states do not permit the exclusion or limitation of incidental or consequential damages, so the above may not apply to you.

This warranty gives you specific legal rights, and you may also have other rights which vary from state to state or province to province.

**\*Important: Carefully pack item to avoid damage in shipping. Be sure to include proof of purchase date and to attach tag to item before packing with your name, complete address and phone number with a note giving purchase information, model number and what you believe is the problem with item. We recommend you insure the package (as damage in shipping is not covered by your warranty). Mark the outside of your package "ATTENTION CUSTOMER SERVICE". We are constantly striving to improve our products, therefore the specifications contained herein are subject to change without notice.**



## OWNERSHIP REGISTRATION CARD FOR CANADIAN CONSUMERS ONLY

Please fill out and mail the product registration card within ten (10) days of purchase. The registration will enable us to contact you in the unlikely event of a product safety notification. By returning this card you acknowledge to have read and understood the instructions for use, and warnings set forth in the accompanying instructions.

Return to: **EURO-PRO Operating LLC**, 4400 Bois Franc, St. Laurent, QC H4S 1A7

<b>Model EP604</b>			
<b>Appliance model</b>			
<b>Date purchased</b>		<b>Name of store</b>	
<b>Owner's name</b>			
<b>Address</b>	<b>City</b>	<b>Prov.</b>	<b>Postal Code</b>

# IMPORTANT SAFETY INSTRUCTIONS

When using your *vacuum* basic safety precautions should always be observed, including the following:

1. Read all instructions before using your vacuum.
2. Use the system only for its intended use.
3. To protect against a risk of electric shock, do not immerse any part of the system in water or other liquids.
4. Never yank cord to disconnect from outlet; instead, grasp plug and pull to disconnect.
5. **Do not** allow cord to touch hot surfaces.
6. **Do not** run appliance over cord.
7. **Do not** operate the system with a damaged cord or plug, or if the appliance or any other part of the system has been dropped or damaged. To avoid the risk of electric shock, do not disassemble or attempt to repair the unit. Return the system to **EURO-PRO Operating LLC** (see warranty) for examination and repair. Incorrect re-assembly or repair can cause risk of electrical shock or injury to persons when the vacuum is used.
8. Close supervision is necessary for any appliance being used by or near children. **Do not** leave the system unattended while connected.
9. Keep hair, loose clothing, fingers and all parts of body away from opening and moving parts.
10. **Do not** use to pick up flammable or combustible liquids such as gasoline or use in areas where they may be present.
11. **Do not** pick up anything that is burning or smoking such as cigarettes, matches or hot ashes.
12. Use extra care when cleaning on stairs.
13. **Do not** use the vacuum without the HEPA-Type filter in place.
14. This appliance is intended only for household use. Follow all user instructions in this manual.

### To reduce the risk of fire, electric shock, or injury:

- **Do not** leave the vacuum plugged in when unattended. Unplug the electrical cord when not in use and before servicing.
- **Do not** allow to be used as a toy. Close attention is necessary when used by or near children, pets or plants.
- Use only as described in this manual. Use only manufacturer's recommended accessories.
- **Do not** pull cord, use cord as a handle, close a door on cord, or pull cord around sharp edges or corners. Keep cord away from heated surfaces.
- Always hold the plug when rewinding the power cord. **Do not** allow plug to whip when rewinding.
- Use **only** extension cords UL-rated or cUL at 15 amperes. Extension cords rated for less amperage may overheat. Care should be taken to arrange the cord so that the cord cannot be pulled or tripped over.
- Turn off all controls as applicable before unplugging from electrical outlet.
- **Do not** handle plug or vacuum with wet hands or operate without shoes.
- **Do not** put any objects into openings. **Do not** use with any opening blocked. Keep free of dust, lint, hair and anything else that may reduce air flow.
- Store your appliance indoors in a cool, dry area.
- Keep your work area well lit.
- Keep end of hose, wands and other openings away from your face and body.
- Use only on dry surfaces.
- Using improper voltage may result in damage to the motor and possible injury to the user. Correct voltage is listed on rating label.

# SAVE THESE INSTRUCTIONS

## For Household Use Only



**WARNING:** To reduce the risk of electric shock, this appliance has a polarized plug (one blade is wider than the other). This plug will fit in a polarized outlet only one way. If the plug does not fit fully in the outlet, reverse the plug. If it still does not fit, contact a qualified electrician to install the proper outlet. Do not modify the plug in any way.

## GETTING TO KNOW YOUR RETRACTABLE CORD STICK VAC

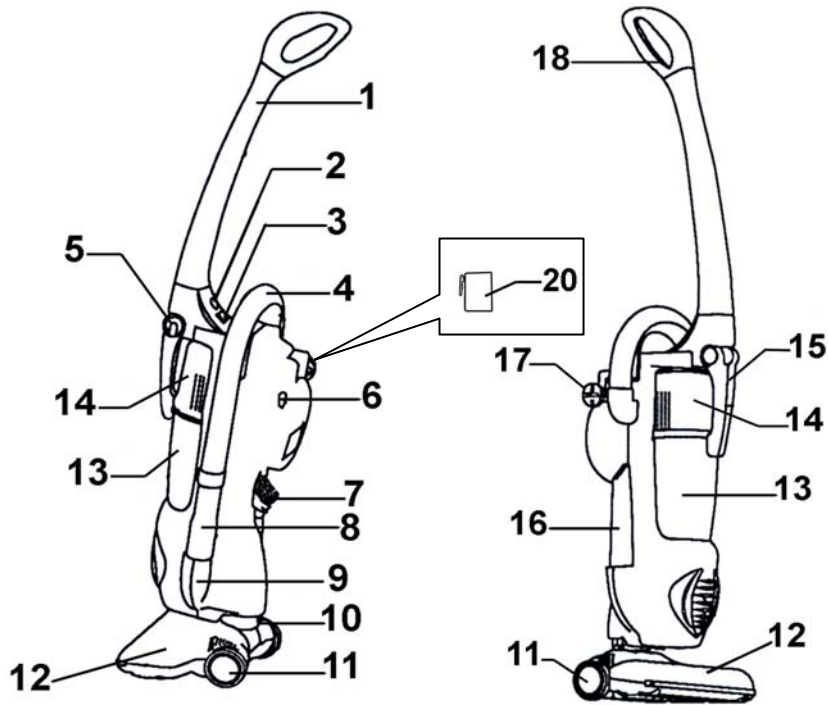

- |  |                                       |
|--|---------------------------------------|
| 1. Handle                                  | 11. Rear Wheel                        |
| 2. Handle Release Button                   | 12. Floor Brush                       |
| 3. On/Off Switch                           | 13. Dust Cup (Container)              |
| 4. Carry Handle/Hose Holder                | 14. Dust Cup Cover                    |
| 5. Dust Cup Retainer Handle Release Button | 15. Dust Cup Retainer Handle          |
| 6. Cord Rewind Button                      | 16. Crevice Tool                      |
| 7. Dusting Brush                           | 17. Power Cord                        |
| 8. Flexible Hose                           | 18. Easy Grip Handle                  |
| 9. Flexible Hose Holder                    | 19. HEPA-Type Filter *not illustrated |
| 10. Floor Brush Release Button             | 20. Handle Storage Clip               |

### Technical Specifications

Voltage: 120V., 60Hz.  
Power: 8.5 Amps

\*Illustration may differ from actual product.

## TROUBLE SHOOTING GUIDE

PROBLEM	POSSIBLE REASON	POSSIBLE SOLUTION
VACUUM WILL NOT OPERATE	<ol style="list-style-type: none"> <li>Power cord not firmly plugged into outlet.</li> <li>No power in wall outlet.</li> <li>Needs servicing.</li> <li>Thermostat has tripped.</li> </ol>	<ol style="list-style-type: none"> <li>Plug unit in firmly.</li> <li>Check fuse or breaker. Replace fuse/reset breaker.</li> <li>Call 1 (800) 798-7398.</li> <li>Turn the unit off and unplug from outlet. Allow unit to cool down, then restart.</li> </ol>
VACUUM WILL NOT PICK-UP OR SUCTION POWER IS WEAK	<ol style="list-style-type: none"> <li>Dust cup (container) is full.</li> <li>Unit clogged.</li> <li>HEPA-Type filter needs cleaning or replacing.</li> </ol>	<ol style="list-style-type: none"> <li>Empty and clean dust cup (container).</li> <li>Turn unit off and unplug from wall outlet. Remove dust cup (container) and check for object(s) in air duct and remove.</li> <li>Clean or replace HEPA-Type filter.</li> </ol>
DUST ESCAPING FROM VACUUM	<ol style="list-style-type: none"> <li>Dust cup (container) is full.</li> <li>Dust cup is not installed correctly.</li> </ol>	<ol style="list-style-type: none"> <li>Empty and clean dust cup (container).</li> <li>Review dust cup instructions.</li> </ol>
VACUUM, HOSE OR BRUSHES WILL NOT PICK-UP	<ol style="list-style-type: none"> <li>Hose clogged.</li> <li>Dust cup (container) is full.</li> </ol>	<ol style="list-style-type: none"> <li>Remove hose and/or brushes. Remove obstruction from hose and /or brush.</li> <li>Empty and clean dust cup (container).</li> </ol>

## ORDERING REPLACEMENT DUST CUP FILTERS

### TO ORDER REPLACEMENT HEPA-TYPE FILTERS for Model EP604

Call: 1 (800) 798-7398

Monday to Friday 8:30 A.M. - 5:00 P.M. Eastern Standard Time  
or visit our website: [www.sharkvac.com](http://www.sharkvac.com)

### FOR TECHNICAL SUPPORT for Model EP604

Call: 1 (800) 798-7398

Monday to Friday 8:30 A.M. - 5:00 P.M. Eastern Standard Time

### Please Note:

The HEPA-Type filter is washable. It should, however, be replaced every three (3) to six (6) months to ensure peak performance of your vacuum.

### Important:

Make sure that **ALL** filters have been completely air dried for 24 hours before re-installing back in the vacuum.

## Cleaning & Changing the HEPA-Type Filter

**PLEASE NOTE:** The white pleated filter material in the HEPA-Type dust cup filter will discolor over time -This is NORMAL and will NOT affect the performance of the filter. If the HEPA-Type dust cup filter is properly "TapCleaned" after each use and suction does not return to 100%, then we suggest that the HEPA-Type filter be "TapCleaned" vigorously until no more dust can be removed, then rinsed under the faucet and allowed to air dry for 24 hours before refitting into the vacuum. (Fig. A) Wash once a month or when suction appears reduced.

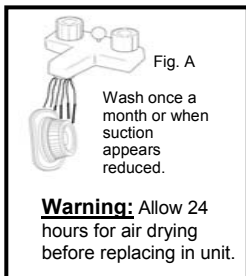

## Re-Installing Dust Cup (Container)

1. Ensure that small air intake vent on the dust cup is aligned with the opening on the main unit. (Fig. 12)
2. Slide the dust cup container into place and lower the dust cup retainer handle.
3. Push retainer handle until you hear it lock into place. (Fig. 13)

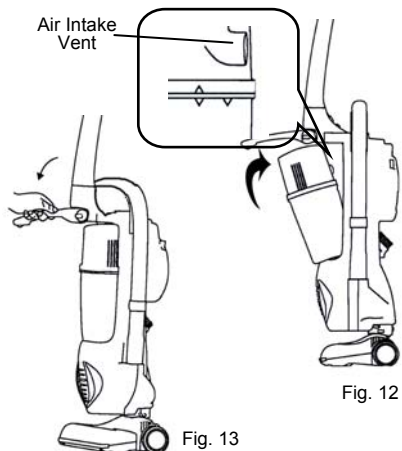

**CAUTION:** The suction hole must be open, free of any obstructions at all times. Otherwise, the motor will overheat and could become damaged.

**Warning:** Always empty the dust cup container and clean the HEPA-Type filter before each use and during prolonged usage. Never over fill the dust cup (container) - remove dirt and clean the HEPA-Type filter when dirt in dust cup is at or below the "MAX" level during prolonged usage or risk motor damage.

**If you wash the HEPA-Type filter, make sure that it is completely air dry before inserting back in the vacuum.**

**Please Note:** The HEPA-Type filter is washable. It should, however, be replaced every three (3) to six (6) months, depending on usage to ensure peak performance of your vacuum.

## Motor Thermostat

**Important:** This unit is equipped with a motor protective thermostat. If for some reason the vacuum cleaner should overheat, the thermostat will automatically turn the unit off. Should this occur:

- Push the On/Off button once.
- Disconnect the plug from the power source.
- Check the source of overheating problem. (i.e. clogged hose or filter)
- If clogged hose or filter is found, unclog the hose and replace the filters.
- Wait at least 45 minutes before attempting to reuse the vacuum.
- After unit has cooled down for 45 minutes, plug in the cleaner and push the On/Off button. The vacuum should start again.
- If the vacuum still does not start, contact customer service at 1 (800) 798-7398.

**IMPORTANT:** If the suction opening in the unit or the hose is BLOCKED, switch off the vacuum cleaner and remove the blocking substance before you start the unit again.

1. Do not operate the vacuum cleaner too close to heaters or radiators.

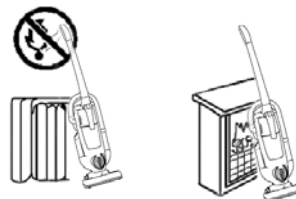

2. Before inserting the power plug into the wall outlet, make sure that your hands are dry.

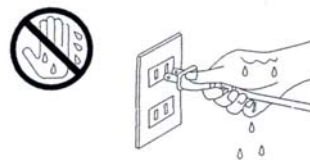

3. Before you start vacuuming, make sure to remove large or sharp objects that might cause damage to the unit.



4. When pulling out the power plug from the wall outlet, pull the plug not the power cord.

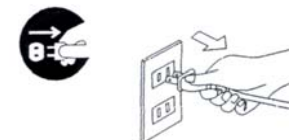

5. Do not pick up anything that is burning or smoking such as cigarettes, matches or hot ashes.



6. Do not vacuum any liquids.

7. Do not use without dust cup (container) or HEPA-Type filter in place.

**Note:** This vacuum cleaner is equipped with a plug and power cord that retract automatically. If the cord or plug get damaged, it must be replaced by a qualified technician.

**Warning:** Hold the plug when rewinding the cord. Do not allow the cord to whip when rewinding.

## OPERATING INSTRUCTIONS

### Assembling Your Vacuum Cleaner

**WARNING:** Always remove the power plug from the wall outlet before assembling or removing accessories.

#### Attaching The Handle

When removing the unit from the box, please note that the handle storage clip is attached to the handle when it is shipped. (Fig. 1) Remove the handle storage clip and attach it to the back of the unit onto the clip mounting slot.

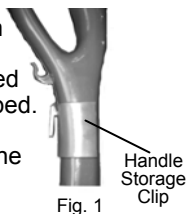

1. Insert the handle into the hole above the dust cup handle.
2. Make sure that the slot in the handle fits correctly into the opening. (Fig. 2)
3. The metal pin should be on the same side as the handle release button. Depress the metal pin and then firmly push in the handle.
4. To remove the handle, press the handle release button and pull the handle up.
5. Attach the handle onto the handle storage clip if desired.

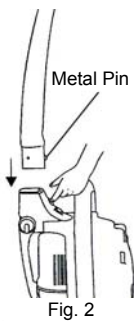

#### Attaching The Floor Brush

1. Insert the floor brush into its location, in the direction of the arrow. (Fig. 3)
2. To remove the floor brush from the vacuum, press on the floor brush release button and pull the floor brush out.

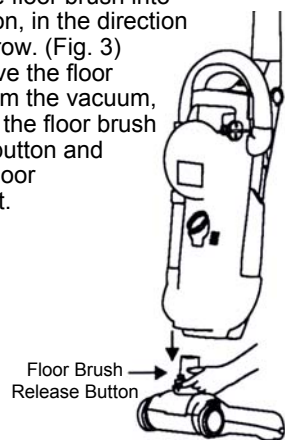
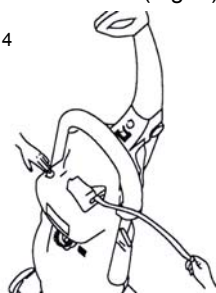

Fig. 3

### Using Your Vacuum

1. Insert the power plug into the wall outlet.
2. Press the power On/Off button located on the unit to turn the vacuum cleaner "On". (Fig. 4)

Fig. 4



3. To rewind the power cord, press the cord rewind button with one hand and guide the power cord with the other hand to ensure that it does not whip causing damage or injury.

**NOTE:** Do Not use dust cup handle to transport the unit, always carry from the carry handle.

#### Using The Attachments

1. Remove the long end of the hose from hose holder.
2. Attach the desired accessory to the hose. (Fig. 5)

**NOTE:** The provided accessories can only be used with the hose. Do not attempt to attach to the base of the vacuum.

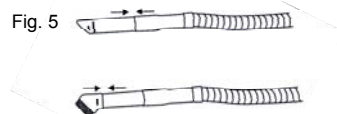

#### Crevice Tool

For radiators, crevices, corners, baseboards and between cushions.

#### Dusting Brush

The dusting brush is used for the furniture, Venetian blinds, lamp shades, shelves, etc.



## OPERATING INSTRUCTIONS

### Removing / Cleaning the Dust Cup

**Warning:** Always unplug the unit from electrical outlet before opening the dust cup (container).

**Important:** Do **NOT** use the vacuum without the HEPA-Type filter in place.

**Warning:** After each Use - Always remove the HEPA-Type filter and the dust cup cover, then vigorously "TapClean" HEPA-Type filter until no more dust can be removed.

1. To remove the dust cup container, press on the dust cup retainer handle release button and lift the retainer handle upwards. (Fig. 6)
2. Grasp the dust cup from the top, tilt downwards and pull it out. (Fig. 7)

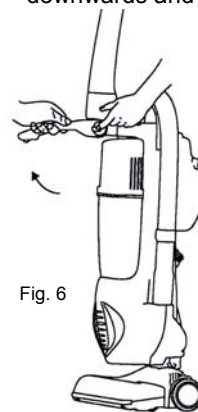

Fig. 6

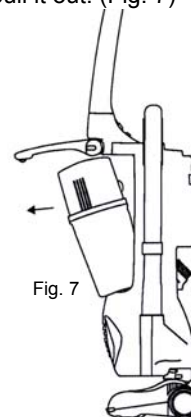

Fig. 7

3. To empty the dust cup (container), turn the dust cup cover clockwise. (Fig. 8)
4. Separate dust cup cover from dust cup (container).
5. Empty dust cup (container).
6. The dust cup (container) and dust cup cover can be wiped down with a damp cloth or rinsed under lukewarm tap water.

**NOTE:** Ensure that dust cup (container) and dust cup cover are completely dry before re-installing into vacuum.

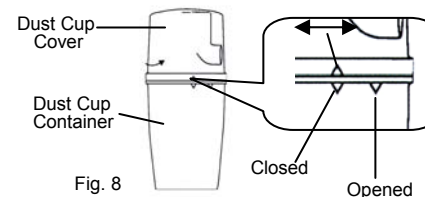

Fig. 8

### Cleaning / Replacing the HEPA-Type Filter

1. To remove the filter cover inside the dust cup cover, turn counter clockwise and lift. (Fig. 9)

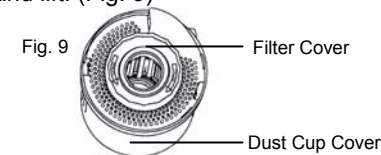

Fig. 9

2. To remove HEPA-Type filter, turn filter counter clockwise and then pull up. (Fig. 10)

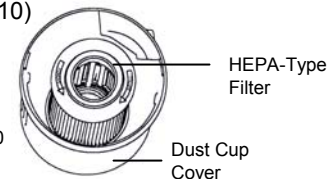

Fig. 10

3. Hold the HEPA-Type filter by the edges and vigorously "TapClean" the HEPA-Type filter on a hard, flat surface until no more dust is observed falling out from between the pleats of the filter. (Fig. 11)
4. The HEPA-Type filter may also be washed by running it under the tap allowing the water to run on the dirty side. We recommend washing it once a month or when suction appears reduced. Always allow 24 hours for air drying before replacing into the vacuum.
5. Reinstall the HEPA-Type filter into dust cup cover.
6. Replace the filter cover.



Fig. 11



## Free Manuals Download Website

<http://myh66.com>

<http://usermanuals.us>

<http://www.somanuals.com>

<http://www.4manuals.cc>

<http://www.manual-lib.com>

<http://www.404manual.com>

<http://www.luxmanual.com>

<http://aubethermostatmanual.com>

Golf course search by state

<http://golfingnear.com>

Email search by domain

<http://emailbydomain.com>

Auto manuals search

<http://auto.somanuals.com>

TV manuals search

<http://tv.somanuals.com>