

SharkTM Trailblazer

OWNER'S MANUAL

Model EP825

120V., 60 Hz, 12 Amps

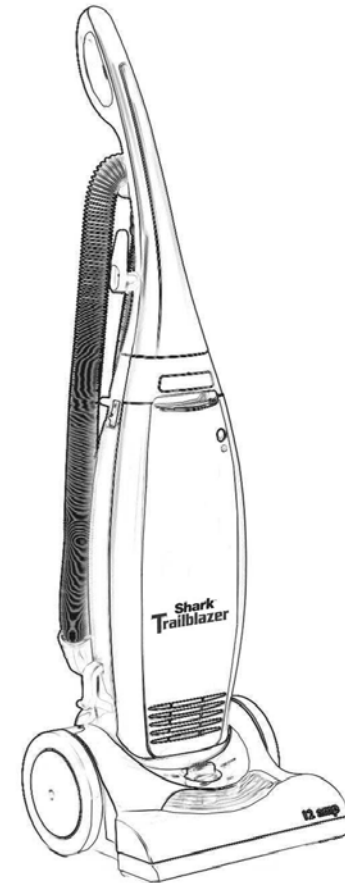

EURO-PRO Operating LLC

94 Main Mill Street, Door 16

Plattsburgh, NY 12901

1 (800) 798-7398

www.sharkvac.com

IMPORTANT SAFETY INSTRUCTIONS

When using your **SHARK Trailblazer**, basic safety precautions should always be observed, including the following:

WARNING: To reduce the risk of fire, electrical shock, or injury:

1. Do not leave vacuum cleaner unattended when it is plugged in. Unplug from outlet when not in use and before removing filters.
2. To reduce the risk of electric shock – do not use outdoors or on wet surfaces.
3. Do not allow children to use as a toy. Close attention is necessary when used by or near children.
4. Use only as described in this manual. Use only manufacturer's recommended attachments.
5. Do not use with damaged cord or plug. Do not use vacuum cleaner if it has been dropped, damaged, left outdoors, or dropped into water. Return appliance to **EURO-PRO Operating LLC** for examination, repair or adjustment.
6. Do not pull or carry by cord. Do not use cord as a handle, close a door on cord, or pull cord around sharp edges or corners. Do not run appliance over cord. Keep cord away from heated surfaces.
7. Do not unplug by pulling on cord. To unplug, grasp the plug, not the cord.
8. Do not handle plug or vacuum cleaner with wet hands.
9. Do not put any objects into openings. Do not use with any opening blocked and do not restrict airflow. Keep all openings free of dust, lint, hair, and anything that may reduce airflow.
10. Keep hair, loose clothing, fingers, feet and all parts of body away from openings, rotating agitator and other moving parts. Do not operate cleaner in bare feet or when wearing open toe shoes.
11. Do not pick up hot coals, cigarette butts, matches or any hot, smoking, or burning objects.
12. Do not pick up hard or sharp objects such as glass, nails, screws, coins, etc.
13. Do not use without filters in place. Use **ONLY** filters and accessories provided by **EURO-PRO Operating LLC**. Failure to do so will void the warranty.
14. Turn off all controls before plugging or unplugging vacuum cleaner.
15. Use extra care when vacuuming on stairs.
16. Do not pick up flammable or combustible materials (lighter fluid, gasoline, kerosene, etc.) or use in the presence of explosive liquids or vapor.
17. Do not pick up toxic material (chlorine bleach, ammonia, drain cleaner, etc.).
18. Do not use in an enclosed space filled with vapors given off by oil based paints, paint thinner, moth proofing substances, flammable dust, or other explosive or toxic vapors.
19. Always unplug this appliance before connecting or disconnecting vacuum hose.
20. Use only on dry, indoor surfaces.
21. Do not use for any purpose other than described in this user's guide.
22. The use of an extension cord is not recommended.
23. **Do not** put any objects into openings. Do not use with any opening blocked. Keep free of dust, lint, hair and anything else that may reduce air flow.
24. Store your appliance indoors in a cool, dry area.
25. Keep your work area well lit.
26. **Do not** immerse the vacuum into water or other liquids.
27. Keep end of hose, wands and other openings away from your face and body.

SAVE THESE INSTRUCTIONS For Household Use Only



WARNING: To reduce the risk of electric shock, this appliance has a polarized plug (one blade is wider than the other). This plug will fit in a polarized outlet only one way. If the plug does not fit fully in the outlet, reverse the plug. If it still does not fit, contact a qualified electrician to install the proper outlet. Do not modify the plug in any way.

Model EP825

EURO-PRO

ONE (1) YEAR LIMITED WARRANTY

EURO-PRO Operating LLC warrants this product to be free from defects in material and workmanship for a period of one (1) year from the date of the original purchase. This warranty applies only to normal domestic household use.

Should your appliance fail to operate properly while in use under normal household conditions within the one (1) year warranty period, return the complete appliance and accessories, freight prepaid to **EURO-PRO Operating LLC** at the address given below. If the appliance is found to be defective in material or workmanship, **EURO-PRO Operating LLC** will repair or replace it free of charge. Proof of purchase date and \$19.95 to cover the cost of return shipping and handling must be included. *

EURO-PRO Operating LLC, 94 Main Mill Street, Door 16, Plattsburgh, NY 12901

If the appliance is found to be defective in material or workmanship, **EURO-PRO Operating LLC** will repair or replace it free of charge. Include \$19.95 to cover the cost of return shipping and handling must be included. *

Non-durable parts including, without limitation, disposable dust bags, drive belts, rotating brushes and electrical parts which normally require replacement are specifically excluded from warranty.

The liability of **EURO-PRO Operating LLC** is limited solely to the cost of the repair or replacement of the unit at our option. This warranty does not cover normal wear of parts and does not apply to any unit that has been tampered with or used for commercial purposes. This limited warranty does not cover damage caused by misuse, abuse, negligent handling or damage due to faulty packaging or mishandling in transit. This warranty does not cover damage or defects caused by or resulting from damages from shipping or repairs, service or alterations to the product or any of its parts, which have been performed by a repair person not authorized by **EURO-PRO Operating LLC**.

This warranty is extended to the original purchaser of the unit and excludes all other legal and/or conventional warranties. The responsibility of **EURO-PRO Operating LLC** if any, is limited to the specific obligations expressly assumed by it under the terms of the limited warranty. **In no event is EURO-PRO Operating LLC** liable for incidental or consequential damages of any nature whatsoever. Some states do not permit the exclusion or limitation of incidental or consequential damages, so the above may not apply to you.

This warranty gives you specific legal rights, and you may also have other rights which vary from state to state.

***Important: Carefully pack item to avoid damage in shipping. Be sure to include proof of purchase date and to attach tag to item before packing with your name, complete address and phone number with a note giving purchase information, model number and what you believe is the problem with item. We recommend you insure the package (as damage in shipping is not covered by your warranty). Mark the outside of your package "ATTENTION CUSTOMER SERVICE". We are constantly trying to improve our products, therefore the specifications contained herein are subject to change without notice.**

Shark™ Trailblazer Upright Vacuum

TO ORDER REPLACEMENT BAGS, FILTERS OR BELTS

for Model EP825

Call: 1 (800) 798-7398

Monday to Friday 8:30 A.M. - 5:00 P.M. Eastern Standard Time
or

visit our website: www.sharkvac.com

FOR TECHNICAL SUPPORT for Model EP825

Call: 1-800-798-7398

Monday to Friday 8:30 A.M. - 5:00 P.M. Eastern Standard Time

Please Note:

Both the Pre-Motor and Post Motor Filters are washable. They should however be replaced every three (3) months to ensure peak performance of your vacuum.

Important:

Make sure that the Filters have **completely** air dried for 24 hours before inserting back in the vacuum.

Please Note:

The Cloth Bag is washable. Let the cloth dust bag air dry completely for 24 hours before replacing into the vacuum. It should however be replaced every three (3) months to ensure peak performance of your vacuum.

Never reuse the paper bags.

GETTING TO KNOW YOUR SHARK TRAILBLAZER

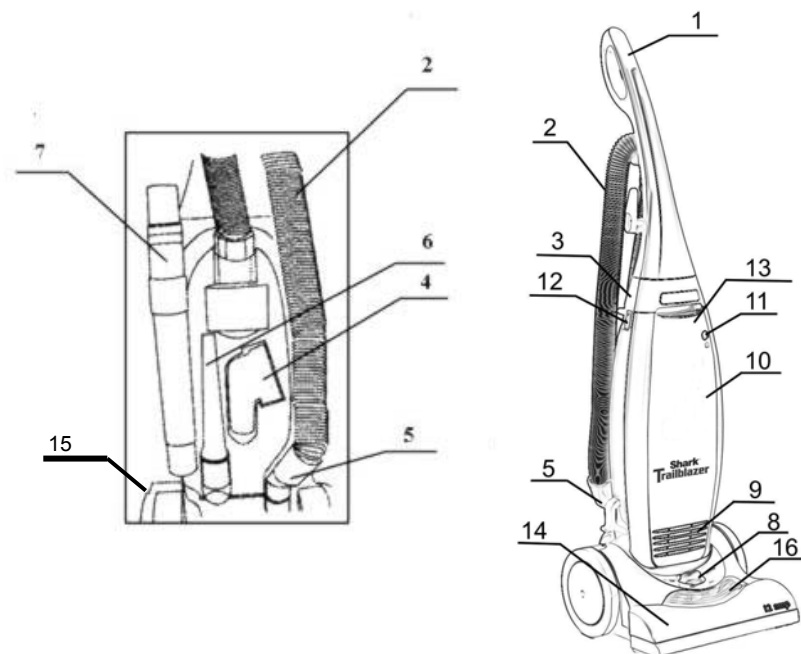

- | | |
|----------------------------------|--------------------------|
| 1. Upper Handle | 9. Exhaust Filter |
| 2. Flexible Hose | 10. Front Panel |
| 3. Main Body | 11. Full Bag Indicator |
| 4. Dusting Brush | 12. On/Off Switch |
| 5. Hose Connector | 13. Lock Plate |
| 6. Crevice Tool | 14. Motorized Power Head |
| 7. Nested Extension Tubes (2) | 15. Handle Release |
| 8. Carpet Height Adjustment Knob | 16. Head Light |

Technical Specifications

Voltage: 120V., 60Hz.
Power: 12 Amps

OPERATING INSTRUCTIONS

Assembling Your Vacuum Cleaner

! WARNING: Always remove the power plug from the wall outlet before assembling or removing accessories.

1. Carefully unpack all components, set aside packaging.
2. Lift vacuum body to upright position.
3. Remove the screws (2) that are already attached to the body. (Fig. 1)
4. From the rear of the vacuum, align the handle with groove and slide onto vacuum. If necessary, use thumb and finger pressure to slide handle into position.
5. Once handle is in place, attach the handle with the screws (2).

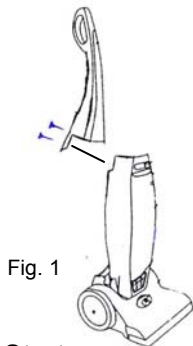

Fig. 1

How to Start

The upright vacuum can be used on multiple types of carpeting, bare floors or upholstery with attachments. When using the attachment tools such as the crevice tool and the dusting brush, place the handle of the vacuum in the upright position and the carpet height adjustment to the "High Carpet" setting.

1. Adjust the motorized power head for the correct carpet height from low to high.
2. Plug power cord into electrical outlet.
3. Step on the handle release button to release the handle. (Fig. 2)
4. Press the On/Off button to the On position.
5. You are now ready to vacuum.

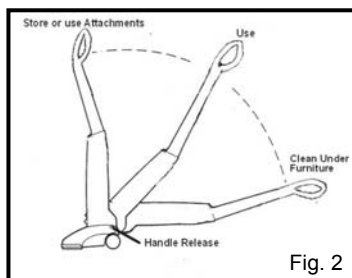

Fig. 2

Carpet Height Adjustment

! WARNING: To avoid injury, keep loose clothing, hair, fingers and all other parts of body away from any moving part (such as the beater brush). Turn off the switch and unplug the vacuum before adjusting the vacuum for the carpet height.

To select a pile height setting:

1. Turn vacuum cleaner "Off".
2. Select a pile height setting by tilting the vacuum cleaner back until the front wheels are lifted slightly off the floor.
3. Turn the height adjustment knob to the desired setting.

Suggested Pile Height Setting:
You may need to raise the height of the vacuum to make some jobs easier, such as scatter rugs and longer pile carpets. Suggested settings are:

 : shag carpet, long pile, plush scatter rugs, tools

 : medium to long pile

 : short to medium pile

 : very low pile, hardwood floors

Place unit in "HIGH" setting when using attachments to prevent possible floor damage.

Attention: Special care is required when vacuuming certain types of carpet or floor covering. Always check the carpet or floor covering manufacturer's recommended cleaning instructions before vacuuming.

PROBLEM SOLVING

This appliance was inspected thoroughly and was in good operating condition when it was shipped from the factory. If a minor problem occurs, it usually can be solved quite easily when the cause is found. Therefore, this checklist is provided for your convenience.

PROBLEM	POSSIBLE CAUSE	POSSIBLE
Cleaner Won't Run	<ol style="list-style-type: none"> 1. Not properly plugged into wall outlet. 2. No electricity in wall outlet. 3. On/Off switch not turned on. 4. Motor thermostat tripped. 5. Blown fuse/tripped breaker. 	<ol style="list-style-type: none"> 1. Plug in firmly. 2. Check fuse or breaker. 3. Push on/off switch to on 4. Reset motor thermostat. (page 7) 5. Reset circuit breaker or replace fuse.
Cleaner Won't Pick Up	<ol style="list-style-type: none"> 1. Full dust bag. 2. Wrong pile height setting. 3. Clogged nozzle. 4. Clogged dust inlet port. 5. Clogged hose. 6. Broken belt. 7. Hose not inserted fully. 8. Dirty filters. 	<ol style="list-style-type: none"> 1. Change dust bag. (page 5) 2. Adjust setting. (page 3) 3. Remove obstruction. 4. Remove power head cover and remove obstruction. 5. Remove obstruction. 6. Replace belt. (page 6) 7. Push hose in securely. 8. Clean / change filters. (page 6)
Cleaner Picks Up Moveable Rugs Or Pushes Too Hard	<ol style="list-style-type: none"> 1. Wrong pile height setting. 	<ol style="list-style-type: none"> 1. Adjust setting. (page 3)
Agitator Does Not Turn	<ol style="list-style-type: none"> 1. Broken belt. 2. Belt installed incorrectly. 	<ol style="list-style-type: none"> 1. Replace belt. (page 6) 2. Check belt changing and agitator cleaning. (page 6)
Air Flow Restricted With Attachment Use Sound Changes	<ol style="list-style-type: none"> 1. Attachment use restricts air flow. 2. New carpet debris clogging air path. 	<ol style="list-style-type: none"> 1. Check attachment. 2. Remove obstruction.

OPERATING INSTRUCTIONS

5. Changing the Head Light Bulb:

Warning: Always disconnect from power source when servicing or cleaning the unit. Failure to do so could result in electrical shock or personal injury from cleaner suddenly starting.

- Turn unit "Off" and unplug from wall outlet.
- Insert the edge of a flat edge screw driver into the locking tab on the headlight lens and pull the handle of the screw driver towards you. **Do NOT** push with the blade of the screw driver against the lens because it might cause it to break.
- Remove the lens. (Fig. 12)
- Remove the light bulbs by pulling them out carefully.
- Push the new light bulbs in and replace the lens cover.
- Make sure that it snaps in place.

Note: Always replace the light bulb with the same or smaller wattage size (12V 4W) to prevent damage to the surrounding parts.

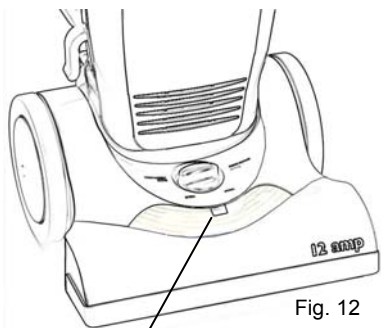

Fig. 12

Lens locking tab

Motor Thermostat

Important: This unit is equipped with a motor protective thermostat. If for some reason the vacuum cleaner should overheat, the thermostat will automatically turn the unit off. Should this occur:

- Push the On/Off button once.
- Disconnect the plug from the power source.
- Check the source of overheating problem. (i.e. clogged hose or filter)
- If clogged hose or filter is found, unclog the hose and replace the filters.
- Wait at least 45 minutes before attempting to reuse the vacuum.
- After unit has cooled down for 45 minutes, plug in the cleaner and push the On/Off button. The vacuum should start again.
- If the vacuum still does not start, contact customer service at 1-800-798-7398.

OPERATING INSTRUCTIONS

Using the Attachments

- Warning:**
- **Always** turn vacuum "Off" before attaching the accessories.
 - Do **NOT** place hands or feet underneath the agitator brush at any time. When using the attachments, the agitator brush continues to rotate.
 - Do **NOT** allow the vacuum cleaner to remain in just one place for a long period of time as the agitator may damage the floor surface.
 - **NEVER** place the vacuum cleaner on furniture, the fringed area of rugs, deep pile carpeting or carpeted stairs. The ideal position for the vacuum cleaner when using any attachment is for the unit to be on a level surface with the handle in the upright position and the carpet height adjustment knob in HIGH.

1. Place vacuum in its upright position.
2. Make sure that the vacuum cleaner is **NOT** plugged into the electrical outlet.
3. Turn the carpet adjustment knob to the high pile position.
4. Pull the hose connector from the rear of the vacuum and push the desired attachment firmly onto the end of the hose. (Fig. 3)
5. If additional length is required, attach one or both of the extension tube to the end of the hose and then attach the crevice tool or dusting brush to the end of the extension tube.

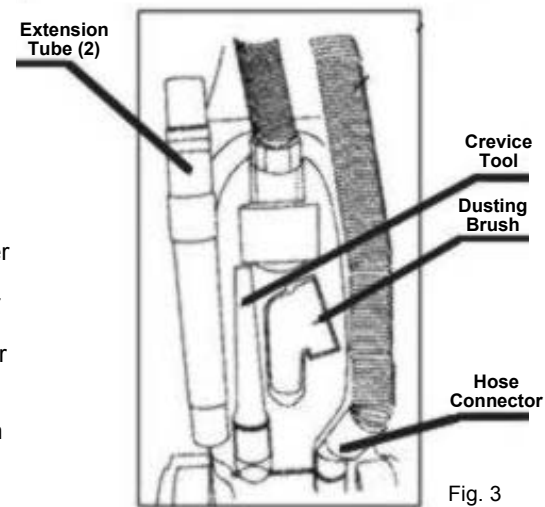

Fig. 3

Warning: When the vacuum is turned on, the beater brush will continue to rotate. Avoid tipping the vacuum or setting it on furniture, fringed area rugs or carpeted stairs while you are using the hose with the attachments. Avoid leaving the vacuum in one place for an extended period of time, particularly on thick carpet.

Important: If the bag is not inserted correctly into the housing, the cover will not close. Please make sure that the bag is inserted all the way in until the latch catches otherwise front cover will not close.

ATTACHMENT USE CHART

ATTACHMENT	CLEANING AREA				
	Furniture	Between Cushions	Drapes	Stairs	Walls
DUSTING BRUSH	*		*	*	*
CREVICE TOOL	*	*		*	

Maintenance & Care

For best cleaning results, the dust bag should be changed often. The use of powder carpet fresheners can decrease the effectiveness of the dust bag filtering system by clogging the bag and not allowing air to flow through properly. We recommend that hard objects, pins, broken glass, paper clips, etc. be picked up from the floor before vacuuming. Although, your vacuum will pick them up, they could do severe damage to the vacuum.

Use genuine **Shark Trailblazer** dust bags, belts and filters only to insure top performance from your vacuum.

1. Changing the Dust Bag:

- Your vacuum comes with both paper bags and a reusable cloth bag. To change bags:
- Unplug power cord from wall outlet.
 - Remove the front panel of the unit. (Fig. 4)
 - Remove the old dust bag by holding the cardboard tab and pull towards you. Remove carefully to avoid dust/dirt spilling from dust bag. (Fig. 5 & Fig. 6))
 - Take a new dust bag and while holding the cardboard tab push the bag over the opening of the dirt discharge tube until it is seated against the rear of the enclosure. (Fig. 7)
 - Make sure that the entire bag is correctly inserted inside the housing, before replacing the front panel. Always check the pre-motor and post motor filters every time you change the dust bag.
 - Once the new dust bag is in place, replace the front panel by aligning the bottom locking tabs with the slots in the body, close cover slowly allowing the front panel to snap in place. The latch will self lock.

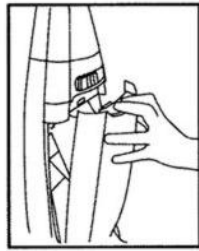

Fig. 4

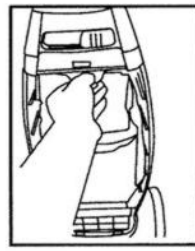

Fig. 5



Fig. 6

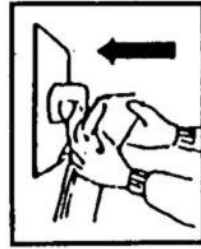

Fig. 7

2. Emptying the Cloth Dust Bag:

- Hold the dust bag over a dustbin. Remove the clip by sliding it off the dust bag sideways. (Fig. 8)
- Shake the contents of the dust bag into the dustbin.
- Close the dust bag by sliding the clip back onto the bottom edge of the dust bag.

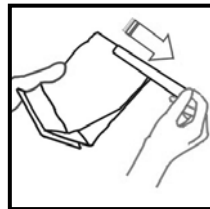

Fig. 8

Note: The Cloth Dust Bag may be washed in warm, soapy water. Always allow the cloth dust bag to air dry completely for 24 hours before replacing into the vacuum.

3. Changing the Filters:

- This is best done every three months or depending on the amount of usage.
- Remove the front panel of the vacuum cleaner.
- The post filter is facing the front of the unit on the bottom and the pre-motor filter is located underneath the bag. To remove the post motor filter, pull the locking tab on the right and it will snap out. To remove the pre-motor filter, simply slide it out.
- To clean the filters rinse in warm, soapy water. Filters must be completely air dried for 24 hours before re-installing into your vacuum.
- Once filters have been replaced, replace front panel.

NOTE: DO NOT OPERATE THE VACUUM WITHOUT ALL THE FILTERS IN PLACE.

Please Note: If you are using the cloth dust bag, you should wash the pre-motor filter in lukewarm water once or twice a year. Always let the pre-motor filter air dry completely for 24 hours. Make sure that the filter is completely dry before you put it back into the vacuum cleaner.

Please Note: The cloth dust bag is washable. **DO NOT WASH IN WASHING MACHINE. AIR DRY FOR 24 HOURS ONLY.** It should however be replaced every three (3) months to ensure peak performance of your vacuum.

4. Changing the Power Nozzle Belt:

- Occasionally the power nozzle drive belt will require changing, the frequency will depend upon the amount of use your vacuum sees.
- Turn unit "Off" and unplug from wall outlet.
- Use a Phillips screwdriver and remove the two screws from the back of the motorized power head cover. (Fig. 9)
- Remove the two screws from the bottom of the motorized power head. (Fig. 10)
- If the belt has broken, remove any loose pieces before replacing.
- Grasp the beater bar at either end and lift straight up.
- Place one end of new belt over motor shaft and the other on the round pulley end of the beater bar. (Fig. 11)
- Align the rubber supports at the ends of the beater bar, with the slots in the motorized power head. Push into place. Ensure that the cut-outs on the rubber supports face upwards.
- Replace the two screws from the bottom of the motorized power head and then replace the cover. Then replace the two screws from the back side of the motorized power head.

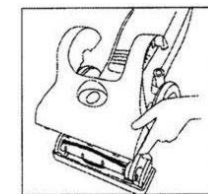

Fig. 9

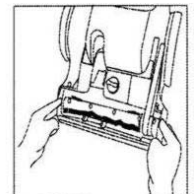

Fig. 10

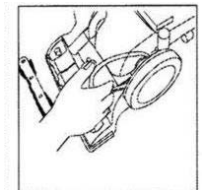

Fig. 11

Free Manuals Download Website

<http://myh66.com>

<http://usermanuals.us>

<http://www.somanuals.com>

<http://www.4manuals.cc>

<http://www.manual-lib.com>

<http://www.404manual.com>

<http://www.luxmanual.com>

<http://aubethermostatmanual.com>

Golf course search by state

<http://golfingnear.com>

Email search by domain

<http://emailbydomain.com>

Auto manuals search

<http://auto.somanuals.com>

TV manuals search

<http://tv.somanuals.com>