

# Shark®

NV36 Series

Owner's Guide



[www.sharkclean.com](http://www.sharkclean.com)

**This manual covers model numbers:**

**NV36 26**

**NV36A 26**

**TECHNICAL SPECIFICATIONS**

Voltage: 120V.

Watts: 1200W

Amps: 10A

Hertz: 60Hz



**TOLL FREE: 1-800-798-7398**

# Contents

Thank you for  
purchasing  
the Shark®  
Navigator™  
Upright Vacuum.

<b>Important Safety Instructions</b>	2
<b>Getting Started</b>	4
<b>Using the Vacuum</b>	6
<b>Cleaning with the Vacuum Accessories</b>	7
<b>Emptying the Dust Cup Assembly</b>	8
<b>Proper Care of Your Vacuum</b>	9
<b>Troubleshooting</b>	10
<b>Checking for Blockages</b>	11
<b>Maintenance</b>	12
<b>Warranty and Registration</b>	13

# IMPORTANT SAFETY INSTRUCTIONS

## For Household Use Only

**WHEN USING YOUR SHARK® NAVIGATOR™ UPRIGHT VACUUM, BASIC SAFETY PRECAUTIONS SHOULD ALWAYS BE FOLLOWED, INCLUDING THE FOLLOWING:**

**READ ALL INSTRUCTIONS BEFORE USING YOUR SHARK® NAVIGATOR™ UPRIGHT VACUUM.**

### **POLARIZED PLUG:**

This appliance has a polarized plug (one blade is wider than the other). As a safety feature, this plug will fit into a polarized outlet only one way.

**Do not force into the outlet or try to modify the plug to fit.**

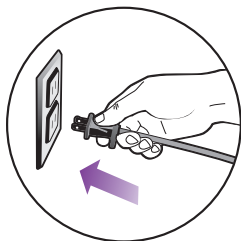

**⚠ WARNING:**  
**TO REDUCE THE RISK OF ELECTRIC SHOCK OR INJURY DO NOT USE OUTDOORS OR ON WET SURFACES.**

### **GENERAL ELECTRICAL SAFETY:**

1. Unplug from electrical outlet when not in use and before servicing.
2. **DO NOT** use vacuum with a damaged cord or plug.
3. **DO NOT** pull or carry vacuum by the cord.
4. **DO NOT** unplug by pulling on cord; to unplug, grasp the plug, not the cord.
5. **DO NOT** handle plug or vacuum cleaner with wet hands.
6. **DO NOT** run the vacuum over the power cord.
7. **DO NOT** close a door on the cord.
8. **DO NOT** pull cord around sharp corners.
9. **DO NOT** leave appliance when plugged in.
10. Keep power cord away from heated surfaces.
11. Turn off all controls before plugging or unplugging vacuum cleaner.
12. Always turn off this appliance before connecting or disconnecting the motorized nozzle

### **HOSE ATTACHMENTS:**

13. **DO NOT** use if air flow is restricted; if the air paths, the hose or the extension tube become blocked, turn the vacuum cleaner off. Remove all obstructions before you turn on the unit again.
14. Keep the end of the hose, wands and other openings away from face and body.
15. Keep rotating brush and suction openings away from hair, face, fingers, uncovered feet or loose clothing.
16. Only use manufacturer's recommended attachments.

### GENERAL USE:

17. Use only as described in this manual.
18. **DO NOT** put any objects into openings.
19. Keep your work area well lit.
20. Keep the vacuum moving over the carpet surface at all times to avoid damaging the carpet fibers.
21. **DO NOT** place vacuum on unstable surfaces such as chairs or tables.
22. **DO NOT** allow young children to operate the vacuum or use as a toy.
23. **DO NOT** use vacuum cleaner if it has been dropped, damaged, left outdoors or submerged in water. Return to EURO-PRO Operating LLC for examination, repair or adjustment.

### CYCLONIC CHAMBER/DUST CUP/FILTERS:

24. Before turning on the vacuum:
  - Make sure that dust cup, cyclonic chamber and all filters are in place after routine maintenance.
  - Make sure that all components and filters are thoroughly dry after routine cleaning.
  - Only use filters and accessories provided by EURO-PRO Operating LLC [Failure to do so will void the warranty].

### GENERAL CLEANING:

25. **DO NOT** run the vacuum over large-sized objects.
26. **DO NOT** pick up hard or sharp objects such as glass, nails, screws or coins that could damage the vacuum cleaner.
27. **DO NOT** pick up smoking or burning objects such as hot coals, cigarette butts or matches.
28. **DO NOT** pick up flammable or combustible materials such as lighter fluid, gasoline, kerosene or use in areas where they may be present.
29. **DO NOT** pick up toxic solutions such as chlorine bleach, ammonia or drain cleaner.
30. **DO NOT** use in an enclosed space where vapors are present from paint, paint thinner, moth-proofing substances, flammable dust or other explosive or toxic materials.
31. **DO NOT** vacuum up any liquids.
32. **DO NOT** immerse vacuum cleaner in water or other liquids.
33. **DO NOT** use outdoors or on wet surfaces; use only on dry surfaces.
34. Use extra care when cleaning on stairs.

## SAVE THESE INSTRUCTIONS

# Getting Started

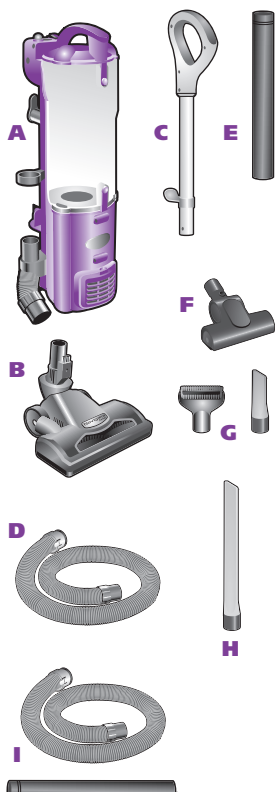

## FIRST THING'S FIRST, YOU NEED TO KNOW WHAT'S IN THE BOX YOU JUST OPENED:

- A** Vacuum Body
- B** Floor Power Nozzle
- C** Handle Assembly
- D** Super Stretch Hose
- E** Cleaning Wand
- F** Pet Hair Power Brush
- G** Cleaning Attachments
- H** 24" Crevice Tool
- I** Extended Reach Kit
- J** Accessory Bag (not shown)

\* **Note:** Optional tools are available for sale for any NV36 model: 1-800-798-7398.

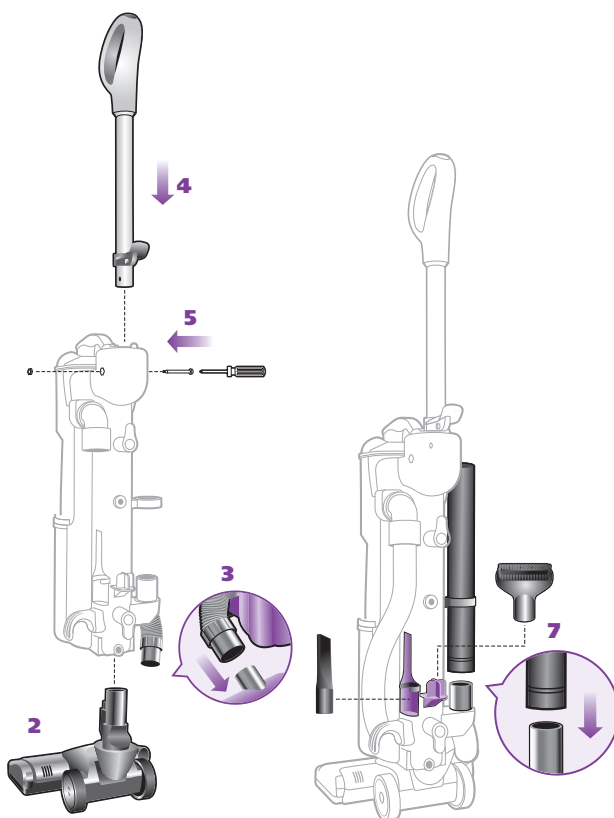

## Your Shark® Navigator™ Upright is easy to assemble:

- 1** Lay your vacuum body on a level surface.
- 2** Slide the electrical connection from the power nozzle into the main body to click into place.
- 3** Connect the hose from the main body to the power nozzle; push with a slight turning motion to create a snug fit.
- 4** Slide the handle assembly into the upright unit aligning the hose hook on the handle assembly with the power cord hooks on the back of the unit.
- 5** Secure the handle assembly in place with included nut/bolt (shipped attached to handle assembly).
- 6** Place the vacuum in the upright position.
- 7** Store the Crevice Tool, Dusting Brush and Cleaning Wand on the unit.



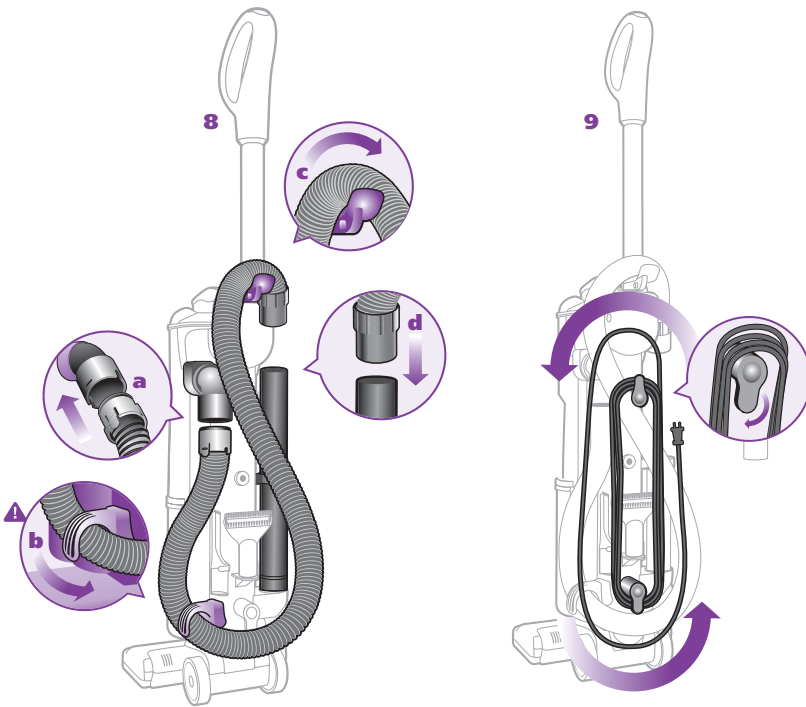

**8** Attach the Super Stretch Hose:

- a)** Snap hose into swivel connector
- b)** Route under anti-tip hook
- c)** Route over upper hose holder
- d)** Press securely onto cleaning wand

**! IMPORTANT:**

To prevent vacuum from tipping, secure hose under the anti-tip hose hook.



**9** To store the vacuum:

When storing your vacuum, wind the cord around the two cord holders and secure with cord clip:

- Quick Cord release at the top of the unit – place in the upright position.
- Cord holder near the base – turn it until it is pointing down.

To release the cord, turn the Quick Cord release to the left or right.

Store the Extended Reach Kit, the Pet Hair Power Brush and the 24" Crevice Tool in the accessory bag when not in use.

**! IMPORTANT:**

For suction to reach the Floor Power Nozzle, the Cleaning Wand and Super Stretch Hose must be attached securely on the vacuum body.

**10** To carry the vacuum:

With the unit in the standing position, lift by the Dust Cup Handle.

**! CAUTION:** When lifting or carrying, **DO NOT** press Dust Cup Assembly release button.

# Using the Vacuum

**! IMPORTANT:** To protect your carpets, the brushroll will only turn on when you have pulled the handle back towards you and released the Floor Power Nozzle.

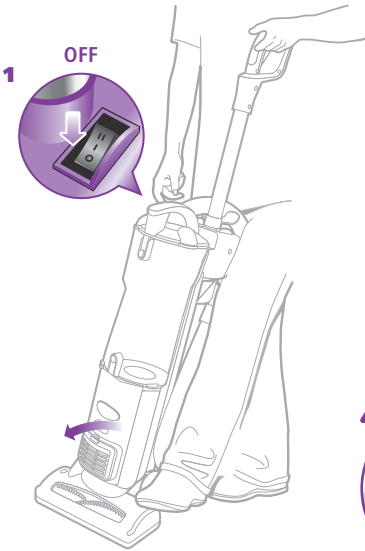

## Bare Floors / Tools

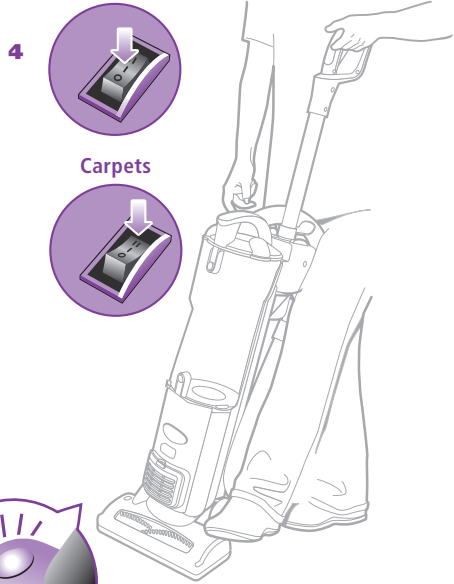

Indicator Light

Your Shark® Navigator™ Upright Vacuum can be used to clean bare floors or carpets – with the click of a switch.

Stand the vacuum into the upright position.

Plug in the vacuum.

- 1 Start with the Power Switch in the "0" - Off position.
- 2 Place your foot on the Floor Power Nozzle and pull handle towards you.
- 3 Set the Power Switch to desired cleaning setting.

## 4 When cleaning carpets:

Ensure you have pulled the handle towards you and select the "II" - Brushroll On position to agitate the carpet fibers for deeper cleaning performance.

## When cleaning bare floors:

Select the "I" - On position for suction only cleaning to avoid scattering dirt while cleaning.

## ! IMPORTANT:

Your Brushroll Indicator Light will illuminate solid green when the brushroll is on, or solid red if there is a blockage. This feature is designed to protect your Lifetime Belt that powers your brushroll. **See Checking for Blockages on page 11.**

**! NOTE:** The height of your power nozzle has been optimized for easy pushing and superior cleaning on all floor types, so there is no need to make any height adjustments as you transition to different floor & carpet types.





# Cleaning with the Vacuum Accessories

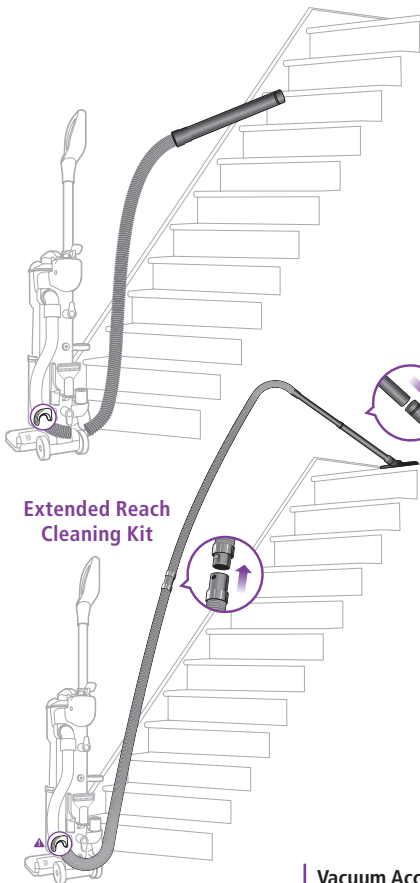

**Extended Reach Cleaning Kit**

Before cleaning with your accessories:

Stand vacuum into upright position.

**Secure Super Stretch Hose in the anti-tip hose hook to prevent tipping.**



Select the "1" - On position for suction only cleaning.

**⚠ DO NOT** pull vacuum cleaner around by the hose.

**⚠ DO NOT** overextend the hose.

## Vacuum Accessories

Your vacuum comes with a Super Stretch Hose and Cleaning Wand. Use one or the other to attach your cleaning accessories.

### 1 Using the Super Stretch Hose:

Stand the vacuum into upright position.

Remove the hose from the Cleaning Wand.

Push the selected tool into the hose connector.

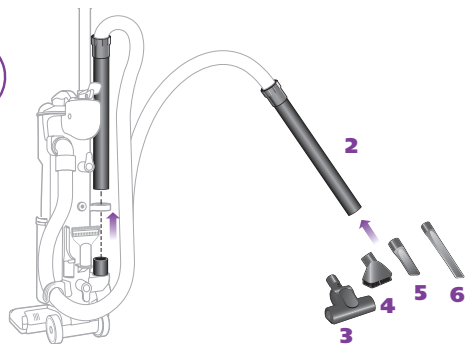
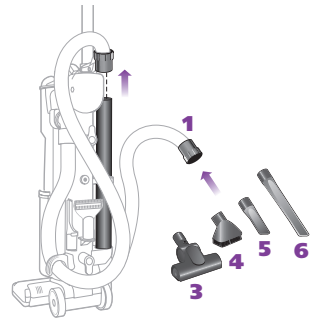

### 2 Using the Cleaning Wand:

Stand the vacuum into upright position.

Remove the Cleaning Wand (with hose attached) from the unit.

Push the selected tool into the end of the Cleaning Wand.

### 3 Pet Hair Power Brush

### 4 Dusting Brush

### 5 Crevice Tool

### 6 24" Crevice Tool

### Extended Reach Cleaning Kit

Includes an extra Cleaning Wand and extra Super Stretch Hose.

**Increases your cleaning reach to over 27 feet!**

To order additional parts and accessories, go to [www.sharkclean.com](http://www.sharkclean.com) or call 1-800-798-7398.

# Maintenance

For best results empty the Dust Cup after each use; empty several times during prolonged usage, or when it reaches the **MAX** fill line.

## NEVER OVER-FILL THE DUST CUP.

Stand vacuum into upright position.  
Turn vacuum off.

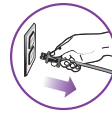

**CAUTION:**  
Unplug the vacuum;  
failure to do so might  
result in electric  
shock.

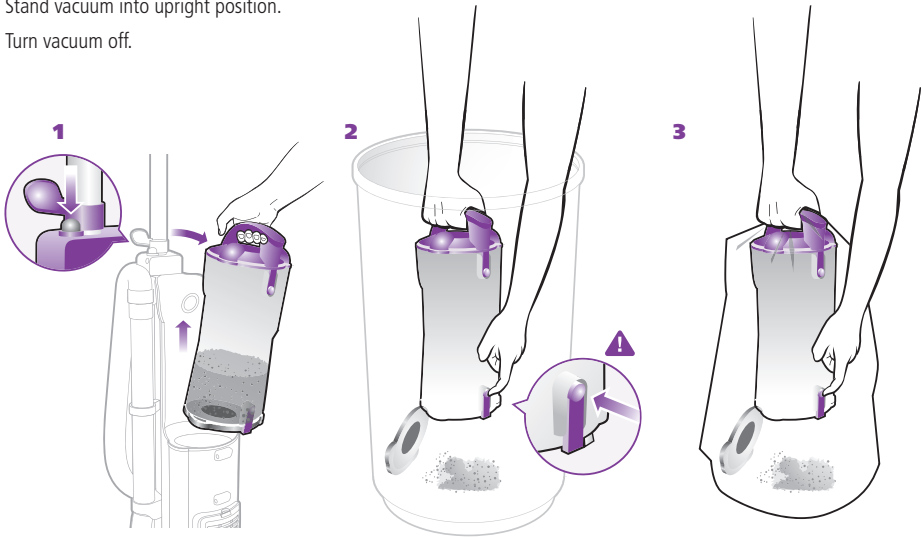

### To empty the Dust Cup:

**1** Grip carry handle and press the Dust Cup release button to remove.

**2 Option A:** For Quick Empty: Insert Dust Cup deep inside trash receptacle to contain dust and debris.

Press the bottom Dust Cup release button; tap container gently to dislodge and release dust and debris.

Snap door in place.

**! Important:** If the Dust Cup Door does not swing open after pressing the release button, push the door open using the bottom door tabs.

**3 Option B:** For Allergy Sufferers: Wrap a trash bag around the Dust Cup leaving space at the bottom for the door to swing open.

Locate the Dust Cup Door release button within the trash bag and press to release as you shake the dust cup to empty dust and debris.

Snap the bottom door in place.

**! Note:** Option B can also be performed outside of the home to further minimize releasing dust back into the air. Carry just the Dust Cup and trash bag outside.

**! Note:** Some dust and debris may remain in the top of your dust cup on or near the metal screen. It is not necessary to completely remove this material before continuing to vacuum; Shark® advanced cyclonic action will sweep the metal screen clean once you begin to refill your dust cup.

COMPONENT	MAINTENANCE SCHEDULE
1 Dust Cup	Empty each time you vacuum.
2 Pre-Motor Foam Filter	Rinse and air dry every 3 months under normal use.
3 Pre-Motor Felt Filter	Rinse and air dry every 3 months under normal use.
4 Post-Motor Filter	Clean once every 12 months under normal use.

**⚠ DO NOT** operate the vacuum without ALL the filters in place.

**⚠ DO NOT** operate the vacuum with WET filters.

**⚠ IMPORTANT: Loss of Suction may occur** if foam filters are not cleaned every 3 months. Rinse and allow to air dry completely. Foam filters may appear dirty after use - this is normal.

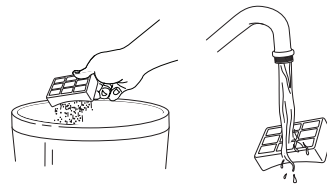
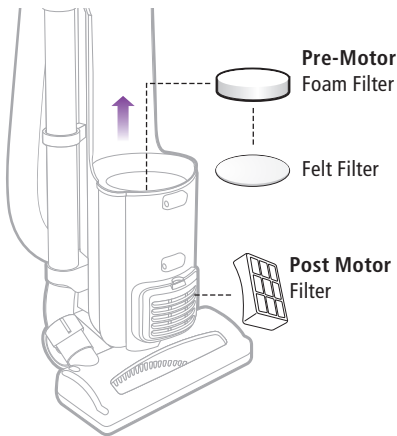

#### To clean the pre-motor filters:

- 1 Remove the dust cup.
- 2 Pull the 2 filters out from the top of the motor base.
- 3 Rinse the filters thoroughly in lukewarm water until the water runs clear.

**⚠ DO NOT** put the filters in the washing machine or dishwasher.

**NOTE:** The material in the filters will discolor over time. This is NORMAL and will not affect the performance of the filters.

- 4 Squeeze out excess water and let air-dry for at least 24 hours before replacing. Do not use a hair dryer or other heating methods to dry.
- 5 Place the felt filter in first, then the foam filter.
- 6 Replace the dust cup.

#### To clean the post-motor filter:

- 1 Remove the filter cover from the front of the vacuum by pulling up on the tab and pulling the cover away from the vacuum.
- 2 Take out the filter by pulling it straight out.
- 3 Turn the filter over so that the dirty side is on the bottom and vigorously tap it clean against a garbage can to remove any dust.
- 4 Wash the filter under the tap using lukewarm water with the dirty side face down until the water runs clear.

**⚠ DO NOT** put the filter in the washing machine or dishwasher.

**NOTE:** The material in the filter will discolor over time. This is NORMAL and will not affect the performance of the filter.

- 5 Allow the filter to air dry for 24 hours. Do not use a hair dryer or other heating methods to dry.
- 6 Once the filter is dry, replace it back into the vacuum.
- 7 Replace the cover by inserting the two tabs into the holes at the bottom and then swinging the cover up until it clicks into place.

# Troubleshooting



**WARNING:**

to reduce the risk of electric shock, the power cord must be disconnected before performing maintenance/troubleshooting checks.

PROBLEM	POSSIBLE REASONS & SOLUTIONS
<p><b>Vacuum is not picking up dirt.</b></p>	<p>Check filters to see if they need cleaning. Follow instructions for rinsing and drying the filters before re-inserting back into the vacuum. (See "Maintenance" sections for instructions.)</p> <p>Dust cup may be full; empty dust cup.</p> <p>Check hose and hose connections for blockages; clear blockages if required.</p> <p>If dust cup is empty, and attachment inlets are clear, check for other blockages. (See "Checking for Blockages" for instructions.)</p>
<p><b>Vacuum lifts scatter rugs (lightweight, movable rugs).</b></p>	<p>Suction is powerful. Take care when vacuuming scatter-type rugs or rugs with delicately sewn edges.</p>
<p><b>Airflow is restricted. No suction or light suction.</b></p>	<p>Check filters to see if they need cleaning. Follow instructions for rinsing and drying the filters before re-inserting back into the vacuum. (See "Maintenance" sections for instructions.)</p> <p>Dust cup may be full; empty dust cup.</p> <p>Check hose, hose connections, nozzles and accessories for blockages; clear blockages if required.</p> <p>Close the suction release on the handle to increase suction power.</p> <p>If dust cup is empty, and attachment inlets are clear, check for other blockages. (See "Checking for Blockages" for instructions.)</p>
<p><b>Motorized floor brush has become jammed or has shut off.</b></p>	<p>Immediately turn off and unplug vacuum, disconnect the nozzle and remove blockage before reconnecting and turning vacuum back on. (See "Checking for Blockages" for instructions.)</p>
<p><b>Vacuum turns off on its own.</b></p>	<p>This vacuum cleaner is equipped with a motor protective thermostat. If for some reason your vacuum overheats, the thermostat will automatically turn the unit off. Should this occur, perform the following steps to restart the motor thermostat:</p> <ol style="list-style-type: none"> <li>1. Move the On/Off switch to the "O" (Off) position.</li> <li>2. Unplug the vacuum.</li> <li>3. Empty the dust cup and clean filters. (See "Maintenance" sections for instructions.)</li> <li>4. Check for blockages in hose, accessories and inlet openings. (See "Checking for Blockages" for instructions.)</li> <li>5. Allow the unit to cool for a minimum of 45 minutes.</li> <li>6. Plug in the vacuum.</li> <li>7. Turn the On/Off switch to the "I" (On) position to restart the vacuum.</li> </ol> <p><b>Note:</b> If vacuum still does not start, contact Customer Service at: <b>1-800-798-7398.</b></p>



# Checking for Blockages

Blockages may cause your vacuum to overheat and shut down. If so, clear the blockages, then follow the instructions for **Resetting the Motor Thermostat** on page 12.

**WARNING:** Never insert sharp objects into any opening to clear an obstruction.

**IMPORTANT:** Damages caused while clearing or attempting to clear blockages are not covered under your product's limited warranty.

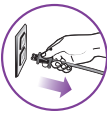

Unplug the vacuum before checking for blockages.

Reassemble all parts securely before operating vacuum.

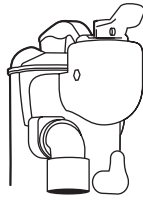
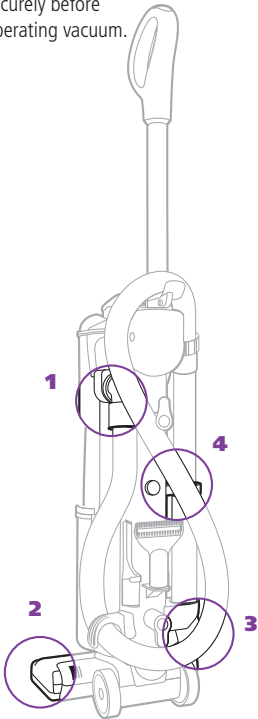

1

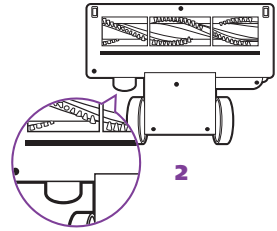
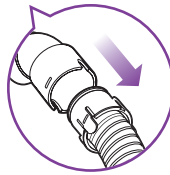

2

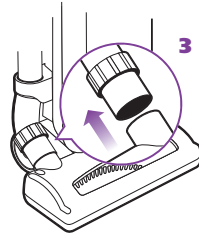

3

## 1 Dust Cup Air Duct:

Stand vacuum into upright position.

Remove Dust Cup Assembly and empty Dust Cup if necessary.

Disconnect the Super Stretch Hose.

Check Air Duct behind Dust Cup for clogs; clear before replacing Dust Cup Assembly.

## 2 Intake Opening behind the Brushroll:

Lay the vacuum flat to expose brushroll.

Check opening behind the brushroll for clogs.

Clear the opening.

Clear the brushroll; use scissors to carefully cut away threads, hair or other debris that might be trapped in the bristles.

## 3 Floor Power Nozzle Hose Connector:

Lay vacuum flat.

Remove Nozzle Hose and check for clogs.

Push the Hose Connector back onto the Floor Power Nozzle.

## 4 Hose:

Stand vacuum upright.

Remove hose from both the unit and Cleaning Wand ends.

Inspect both ends and the length of the hose for clogs.

Return the hose to the unit

# Maintenance

## Resetting the Motor Thermostat

Your Shark® Upright Vacuum is equipped with a protective Motor Thermostat. If the motor should overheat, the thermostat shuts off the power.

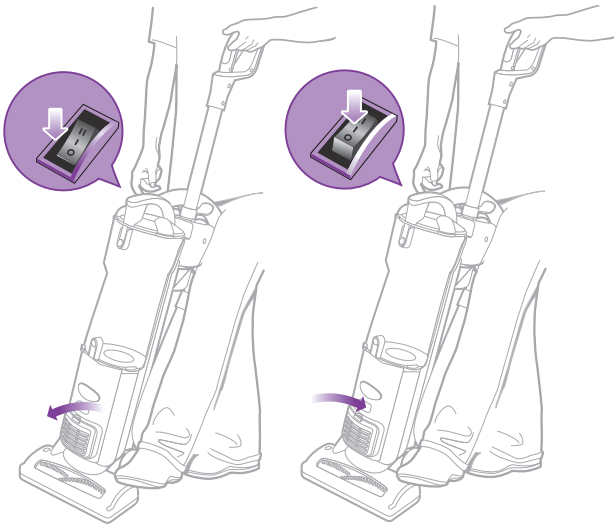

### To reset the Motor Thermostat:

Move the Power Button to the "O" – Off position.

Unplug the vacuum.

Check for clogged hose or filter; unplug hose and replace filter.

Refer to **Checking for Blockages** on page 11.

Wait 45 minutes for vacuum to cool; then plug in the vacuum.

Turn the Power Switch to the "I" – On position to start the vacuum.

Note: If vacuum still does not start, contact Customer Service at: 1-800-798-7398.

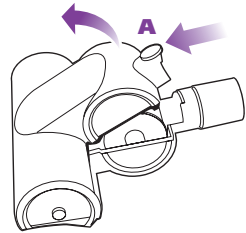

### 1 Cleaning the Pet Hair Power Brush -

Slide locking latch (A) forward.

Gently tilt brush housing upward to open.

**!** **IMPORTANT: DO NOT** force; it will not open all the way.

Remove debris from turbine wheel and air passage.

## Ordering Replacement Parts

To order additional parts and accessories, go to

[www.sharkclean.com](http://www.sharkclean.com)  
or call 1-800-798-7398.

PART	PART NO.
Super Stretch Hose	1114-FC
Dusting Brush & Crevice Tool	1115-FC
Foam & Felt Filters	XF22
Turbo brush	137FFJ
Cleaning Wand	1116-FC
24" Crevice Tool	1124-FC

## Euro-Pro Five-Year (5) Limited Warranty

EURO-PRO Operating LLC warrants this product to be free from defects in material and workmanship for a period of five (5) years from the date of the original purchase, when utilized for normal household use, subject to the following conditions, exclusions and exceptions.

If your appliance fails to operate properly while in use under normal household conditions within the warranty period, return the complete appliance and accessories, freight prepaid to:

- **U.S.: EURO-PRO Operating LLC**  
For customer service support call 1-800-798-7398  
or visit [www.sharkclean.com](http://www.sharkclean.com)
- **Canada: EURO-PRO Operating LLC**  
4400 Bois Franc, St. Laurent, Québec H4S 1A7

If the appliance is found to be defective in material or workmanship, **EURO-PRO Operating LLC** will repair or replace it free of charge. Proof of purchase date and \$16.99 to cover the cost of return shipping and handling must be included.\*

Non-durable parts including, without limitation, filters, brushes and electrical parts which normally require replacement are specifically excluded from warranty.

The liability of **EURO-PRO Operating LLC** is limited solely to the cost of the repair or replacement of the unit at our option. This warranty does not cover normal wear of parts and does not apply to any unit that has been tampered with or used for commercial purposes. This limited warranty does not cover damage caused by misuse, abuse, negligent handling or damage due to faulty packaging or mishandling in transit. This warranty does not cover damage or defects caused by or resulting from damages from shipping or repairs, service or alterations to the product or any of its parts, which have been performed by a repair person not authorized by **EURO-PRO Operating LLC**.

This warranty is extended to the original purchaser of the unit and excludes all other legal and/or conventional warranties. The responsibility of **EURO-PRO Operating LLC** if any, is limited to the specific obligations expressly assumed by it under the terms of the limited warranty. In no event is **EURO-PRO Operating LLC** liable for incidental or consequential damages of any nature whatsoever. Some states do not permit the exclusion or limitation of incidental or consequential damages, so the above may not apply to you.

This warranty gives you specific legal rights, and you may also have other rights which vary from state to state or province to province.

**\*IMPORTANT: Carefully pack item to avoid damage in shipping. Be sure to include proof of purchase date and to attach tag to item before packing with your name, complete address and phone number with a note giving purchase information, model number and what you believe is the problem with item. We recommend you insure the package (as damage in shipping is not covered by your warranty). Mark the outside of your package "ATTENTION CUSTOMER SERVICE". We are constantly striving to improve our products, therefore the specifications contained herein are subject to change without notice.**

---

## Product Registration

Please visit [www.sharkclean.com](http://www.sharkclean.com) or call **1-800-798-7398** to register your new Shark® product within ten (10) days of purchase. You will be asked to provide the store name, date of purchase and model number along with your name and address.

The registration will enable us to contact you in the unlikely event of a product safety notification. By registering you acknowledge to have read and understood the instructions for use, and warnings set forth in the accompanying instructions.

Euro-Pro Operating LLC  
USA: Newton, MA 02459  
CAN: 4400 Bois Franc, St-Laurent, QC H4S 1A7

English: 1-800-798-7398

**[www.sharkclean.com](http://www.sharkclean.com)**

Copyright © Euro-Pro Operating LLC 2011

Printed in China

Illustrations may differ from actual product.

NV36-NV36A.E.110421.1



## Free Manuals Download Website

<http://myh66.com>

<http://usermanuals.us>

<http://www.somanuals.com>

<http://www.4manuals.cc>

<http://www.manual-lib.com>

<http://www.404manual.com>

<http://www.luxmanual.com>

<http://aubethermostatmanual.com>

Golf course search by state

<http://golfingnear.com>

Email search by domain

<http://emailbydomain.com>

Auto manuals search

<http://auto.somanuals.com>

TV manuals search

<http://tv.somanuals.com>