

Shark™

OWNER'S MANUAL

Model SV726N

14.4 V DC

Cordless Hand Vac



EURO-PRO Operating LLC

U.S.: 94 Main Mill Street, Door 16
Plattsburgh, NY 12901

Canada: 4400 Bois-Franc
St-Laurent, QC H4S 1A7

Tel.: 1-866-98SHARK

(1-866-987-4275)

www.sharkvac.com

EURO-PRO X

ONE (1) YEAR LIMITED WARRANTY

EURO-PRO Operating LLC warrants this product to be free from defects in material and workmanship for a period of one (1) year from the date of the original purchase, when utilized for normal household use, subject to the following conditions, exclusions and exceptions.

If your appliance fails to operate properly while in use under normal household conditions within the warranty period, return the complete appliance and accessories, freight prepaid to

EURO-PRO Operating LLC, 94 Main Mill Street, Door 16, Plattsburgh, N.Y. 12901

If the appliance is found to be defective in material or workmanship, **EURO-PRO Operating LLC** will repair or replace it free of charge. Proof of purchase date and \$ 9.95 to cover the cost of return shipping and handling must be included.*

Non-durable parts including, without limitation, dust cup filters, filters, brushes and electrical parts which normally require replacement are specifically excluded from warranty.

The liability of **EURO-PRO Operating LLC** is limited solely to the cost of the repair or replacement of the unit at our option. This warranty does not cover normal wear of parts and does not apply to any unit that has been tampered with or used for commercial purposes. This limited warranty does not cover damage caused by misuse, abuse, negligent handling or damage due to faulty packaging or mishandling in transit. This warranty does not cover damage or defects caused by or resulting from damages from shipping or repairs, service or alterations to the product or any of its parts, which have been performed by a repair person not authorized by **EURO-PRO Operating LLC**.

This warranty is extended to the original purchaser of the unit and excludes all other legal and/or conventional warranties. The responsibility of **EURO-PRO Operating LLC** if any, is limited to the specific obligations expressly assumed by it under the terms of the limited warranty. **In no event is EURO-PRO Operating LLC** liable for incidental or consequential damages of any nature whatsoever. Some states do not permit the exclusion or limitation of incidental or consequential damages, so the above may not apply to you.

This warranty gives you specific legal rights, and you may also have other rights which vary from state to state.

***Important: Carefully pack item to avoid damage in shipping. Be sure to include proof of purchase date and to attach tag to item before packing with your name, complete address and phone number with a note giving purchase information, model number and what you believe is the problem with item. We recommend you insure the package (as damage in shipping is not covered by your warranty). Mark the outside of your package "ATTENTION CUSTOMER SERVICE". We are constantly striving to improve our products, therefore the specifications contained herein are subject to change without notice.**

IMPORTANT SAFEGUARDS

When using an electrical appliance, basic safety precautions should always be observed, including the following

READ ALL INSTRUCTIONS BEFORE USING YOUR CORDLESS HAND VACUUM.

WARNING: To reduce the risk of fire, electrical shock, or injury:

1. Do not charge this unit outdoors.
2. Do not use outdoors or on wet surfaces.
3. Do not allow to be used as a toy. Close attention is necessary when used by or near children.
4. Use only as described in this manual.
5. Use only manufacturer's recommended attachments.
6. Do not use charger if power cord has been damaged. Do not use cordless hand vacuum or charger if it has been dropped, damaged, left outdoors, or dropped in water. Return it to **EURO-PRO Operating LLC** for examination, repair or adjustment.
7. Do not abuse the charger cord. Never carry the charger or base by the cord or yank to disconnect from an outlet; instead grasp the plug and pull to disconnect.
8. Keep charger cord away from heated surfaces.
9. This product includes rechargeable nickel cadmium batteries. Batteries must be recycled or disposed of properly. **Do not incinerate batteries or expose to high temperatures**, as they may explode.
10. Do not handle plug or appliance with wet hands.
11. Do not put any object into openings. Do not use with any opening blocked; keep free of dust, lint, hair and anything that may reduce air flow.
12. Keep hair, loose clothing, fingers, and all parts of body away from openings and moving parts.
13. Do not pick up anything that is burning or smoking, such as cigarettes, matches, or hot ashes.
14. Do not attempt to change accessories while unit is running.
15. Use extra care when cleaning on stairs.
16. Do not use to pick up flammable or combustible liquids such as gasoline or use in areas where they may be present.
17. Look on your hand vacuum and follow all label and marking instructions.
18. Do not use charger with an extension cord. Plug charger directly into an electrical outlet. Use charger only in a standard (120V., 60Hz) electrical outlet.
19. **Do not use the hand vacuum cleaner without dust cup filter in place.**
20. Store the cordless vacuum indoors. Put the cordless vacuum away after use to prevent accidents.
21. Leaks from battery cells can occur under extreme conditions. If the liquid, which is 20-35% solution of potassium hydroxide, gets on the skin - wash immediately with soap and water or neutralize with a mild acid such as lemon juice or vinegar. If the liquid gets into the eyes, flush them immediately with clean water for a minimum of 10 minutes and seek medical attention.
22. Use only on dry, indoor surfaces.
23. Do not use for any purpose other than described in this user's guide.
24. Do not attempt to use the charger with any other product nor attempt to charge this product with another charger. **Use only the charger model KA12D220020034U supplied with this appliance manufactured by Kuantech Co. Ltd..**
25. "Ni-Cd" battery must be recycled or disposed of properly.

SAVE THESE INSTRUCTIONS
For Household Use Only

Shark™

Cordless Hand Vac

Model SV 726N
14.4 V DC

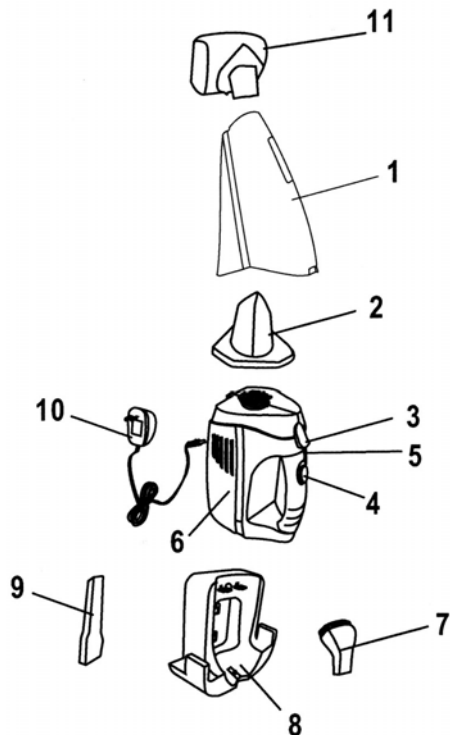

- | | |
|-----------------------------|----------------------|
| 1. Dust Cup Container | 7. Dusting Brush |
| 2. Dust cup filter | 8. Charging Stand |
| 3. Dust cup release button | 9. Crevice Tool |
| 4. On/Off Button | 10. Charging Adapter |
| 5. Charging Indicator Light | 11. Motorized Brush |
| 6. Main Unit | |

NOTE: Cordless vacuum Model SV726N is shipped with the batteries uncharged. Charging of the unit for 20 hours prior to first use is required.

REPLACEMENT FILTERS

TO ORDER REPLACEMENT FILTERS OR BATTERY PACKS for Model SV726N

Replacement dust cup filter SKU# XSB726N
Replacement battery pack SKU# XB14726

Call: 1-866-98SHARK (1-866-987-4275)
Monday to Friday 8:30 A.M. - 5:00 P.M. Eastern Standard Time
or
visit our website: www.sharkvac.com

FOR TECHNICAL SUPPORT

In U.S.: 800-798-7398
Monday to Friday 8:30 A.M. - 5:00 P.M. Eastern Standard Time

Please Note

The Dust Cup Filter is washable. It should, however, be replaced every three (3) months to ensure peak performance of your vacuum.

Important

Make sure that Dust Cup Filter is completely dry before re-installing back in the hand vacuum.

TROUBLESHOOTING GUIDE

PROBLEM	POSSIBLE REASON	POSSIBLE SOLUTION
HAND VACUUM WILL NOT OPERATE	<ol style="list-style-type: none"> 1. Batteries discharged. 2. Dead battery (battery won't hold charge). 3. Contacts between the unit and the charging stand are dirty. 4. No power in electrical outlet supplying transformer. 	<ol style="list-style-type: none"> 1. Charge unit. 2. Replace batteries. (See page 5.) 3. Wipe and clean dirt from contacts. 4. Check fuse or breaker. Replace fuse/reset breaker.
MOTORIZED BRUSH WILL NOT WORK	<ol style="list-style-type: none"> 1. The 2 metal pins of the motorized brush are not in contact with the vacuum cleaner. 2. Motorized brush is clogged up. 	<ol style="list-style-type: none"> 1. Firmly insert the motorized brush into the air-intake nozzle. This will connect the motorized nozzle to the unit power supply. 2. Remove all lint, hair etc. from motorized brush.
HAND VACUUM WILL NOT PICK-UP OR SUCTION POWER IS WEAK	<ol style="list-style-type: none"> 1. Dust cup container is full. 2. Dust cup filter needs cleaning or replacement. 3. Unit needs recharging. 	<ol style="list-style-type: none"> 1. Empty dust cup container 2. Remove dust cup filter and check for object(s) in air duct and remove. Clean or replace dust cup filter. 3. Charge unit.
DUST ESCAPING FROM HAND VACUUM	<ol style="list-style-type: none"> 1. Dust cup container is full. 2. Dust cup filter is not installed correctly. 3. Puncture/hole in dust cup filter. 	<ol style="list-style-type: none"> 1. Empty dust cup container. 2. Review dust cup filter installation instructions. 3. Replace dust cup filter.

Before Use

1. This cordless vacuum is powered by rechargeable nickel-cadmium batteries. Before using the vacuum, charge the vacuum cleaner for a minimum of 20 hours.
NOTE: Ensure that the On/Off switch is in the "Off" position before charging.

NOTE: Peak performance may only be realized after the unit has been charged and discharged two (2) or three (3) times.

IMPORTANT: To maintain peak performance of your cordless hand vacuum, it is recommended that the unit be fully discharged, then completely re-charged at least once a month.

2. Store the vacuum cleaner in the charging base when not in use so that it is always charged and ready to use.

Charging Your Vacuum Cleaner

1. Place the charging base near an electrical power outlet (120 V., 60 Hz.) and plug in the charging adapter's jack into the charging base.
2. Plug the charger into wall outlet.
3. Place the unit in the charging base. The charging indicator light will shine green to indicate that the vacuum cleaner is properly positioned in the charging base and that the unit is being charged. (See Fig. 1)

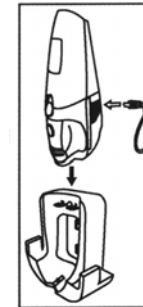

Fig. 1

- NOTE: Ensure that the On/Off switch is in the "Off" position before charging.**
4. Always return the unit to the charging base immediately after use so that it will be ready and fully charged for its next use.

Assembly

Note: Dust cup filter must always be used when operating the hand vacuum.

1. To open the dust cup compartment, push the dust cup release button and remove the dust cup container. (Fig. 2)
2. Verify that the dust cup filter is inside, then re-attach the dust cup container to the hand vacuum. (Fig. 3)

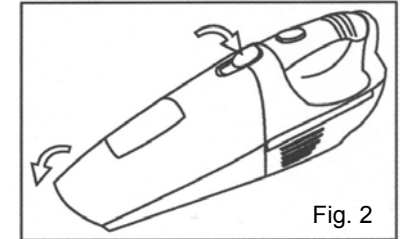

Fig. 2

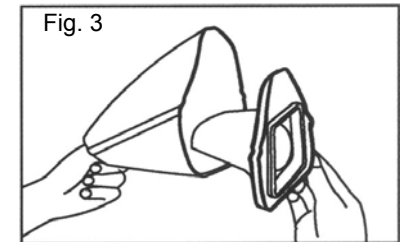

Fig. 3

3. To attach the crevice tool or the dusting brush to the hand vacuum, push the attachment into the suction hole in the front of the dust container. (Fig. 4)

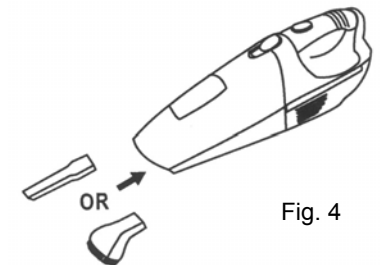

Fig. 4

OPERATING INSTRUCTIONS

Using Your Cordless Vacuum

1. Remove the vacuum cleaner from the charging base
2. To start the unit, push the "On/Off" switch to the "On" position.
3. To stop the vacuum cleaner, slide the "On/Off" switch to the "Off" position.
4. A crevice tool is provided for cleaning narrow, hard to reach places. A dusting brush is provided for cleaning upholstery, furniture, etc.

Using Your Motorized Brush

1. Remove the vacuum cleaner from the charging base
2. Make sure that it is in the "Off" position.
3. Firmly insert the motorized brush (Fig. 5) into the air-intake nozzle of the dust cup container ensuring that the contact pins are engaged in the connector slots of the unit. (Fig. 6)
Please note that this motorized brush is for vacuuming short pile carpets or rugs.

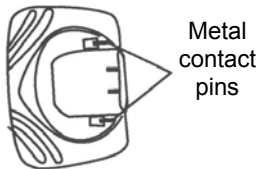

Fig. 5

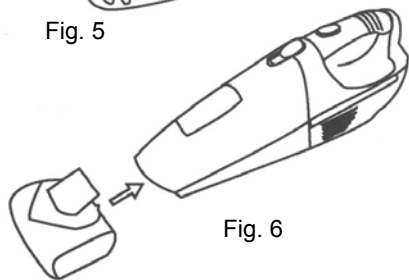

Fig. 6

WARNING: Do not touch the motorized brush while it is in motion.

Changing & Cleaning the Dust Cup Filter

To achieve the best performance, empty the dust cup container and clean the dust cup filter after each use.

1. To remove the dust cup container, press down on the dust cup release button and pull off the dust cup container.
2. Pull out the dust cup filter.
3. Empty the dust from the dust cup container. (See Fig. 7)
4. Rinse the dust cup filter in cold water, and then wait until it dries completely before replacing it back into the dust cup container. Do **not** use a washing machine to clean the dust cup filter. Do not use a hair dryer to dry it. **Air dry only.**
5. Replace the dust cup filter carefully into the dust cup compartment. **NEVER** operate vacuum cleaner without dust cup filter in place.
6. Attach the dust cup container to the cordless vacuum.

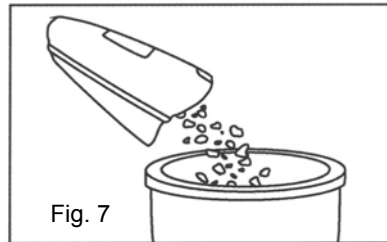

Fig. 7

NOTE: It is recommended that the dust cup filter be replaced every three (3) months to ensure peak performance of the unit.

CAUTION: The suction hole must be open and free of any obstructions at all times. Otherwise, the motor will overheat and could become damaged.

WARNING: NEVER use ordinary batteries for replacement, as these may leak and damage your vacuum cleaner.

OPERATING INSTRUCTIONS

Battery Pack Replacement & Disposal

Model SV726N Cordless Vacuum is powered by Nickel-Cadmium Ni-Cd) batteries, which must be recycled or disposed of properly in accordance with state, federal and local laws.

If uncertain as to how to remove the battery pack, we suggest you take your hand vacuum to a reputable small appliance service technician to have this service performed.

Do NOT attempt to replace the batteries used in this product with any other type of battery.

The battery pack of your SV726N is replaceable, however care should be taken when doing so. Follow these steps when replacement is required:

1. Using a #1 Phillips head screw driver, remove the single screw securing the battery compartment cover located on the under side of the unit.
2. To remove the cover, press down on the battery compartment cover while sliding towards the rear of the unit. **NEVER** open the battery compartment except to change the battery.
3. Set aside battery compartment cover and screw.
4. Using the same Phillips screw driver, remove the single screw securing the battery strap. Lift off the battery strap and set aside with screw.
5. Carefully lift out battery pack and disconnect the terminals.
6. Connect the terminals to the new battery pack taking care to connect the black lead (-) to the negative connector first and the red lead (+) to the positive connector second. Place the new battery into the battery compartment.
7. Tuck the wiring inside the battery compartment so that the wiring does not interfere with the battery compartment cover when it is replaced.
8. Re-install the battery strap and battery compartment cover.

WARNING: NEVER use ordinary batteries for replacement, as these may leak and damage your vacuum cleaner. Use only battery pack XB14726 provided by **EURO-PRO Operating LLC** for replacement.

CAUTION: NEVER use the unit without the battery compartment cover in place.

NOTE: Any other servicing should be performed by an authorized service representative.



"Ni-Cd" BATTERY MUST BE RECYCLED OR DISPOSED OF PROPERLY

CAUTION

- Use only with the battery pack supplied with the unit.
- Do not attempt to remove the battery pack from the unit to charge it.
- Never attempt to throw the battery pack or unit into a fire or incinerate it.
- Do not attempt to remove or damage the battery casing.
- Battery must be recycled or disposed of properly at the end of its service life.

Wall Mounting Bracket (Optional)

1. Make sure that the intended wall area for the wall mounting bracket to be drilled is free from any hidden electrical wires, water pipes and gas lines.
2. Select an appropriate place close to a wall power outlet (120V., 60 Hz).
3. Do not mount near direct sunlight, near a heat source or outdoors.
4. Select an appropriate drill type for the material to be drilled.
5. Carefully measure and mark the location of all bracket holes and then drill holes and screw the wall mounting bracket onto the wall.

Free Manuals Download Website

<http://myh66.com>

<http://usermanuals.us>

<http://www.somanuals.com>

<http://www.4manuals.cc>

<http://www.manual-lib.com>

<http://www.404manual.com>

<http://www.luxmanual.com>

<http://aubethermostatmanual.com>

Golf course search by state

<http://golfingnear.com>

Email search by domain

<http://emailbydomain.com>

Auto manuals search

<http://auto.somanuals.com>

TV manuals search

<http://tv.somanuals.com>