



2 Speed Cordless Sweeper

Model UV611TR

7.2 Volt DC – 7.2 Volt CD - 7,2 Volts CC



U.S : *EURO-PRO Operating LLC*
94 Main Mill Street, Door 16
Plattsburgh, NY 12901

Canada : *EURO-PRO Operating LLC*
4400 Bois Franc
St-Laurent, QC H4S 1A7

1 (800) 798-7398
www.sharkvac.com

EURO-PRO 

Model
UV611TR



ONE (1) YEAR LIMITED WARRANTY

EURO-PRO Operating LLC warrants this product to be free from defects in material and workmanship for a period of one (1) year from the date of the original purchase, when utilized for normal household use, subject to the following conditions, exclusions and exceptions. If your appliance fails to operate properly while in use under normal household conditions within the warranty period, return the complete appliance and accessories, freight prepaid to:

In US: **EURO-PRO Operating LLC**, 94 Main Mill Street, Door 16, Plattsburgh, N.Y. 12901
In Canada: **EURO-PRO Operating LLC**, 4400 Bois Franc, St Laurent, Qc, H9S 1A7

If the appliance is found to be defective in material or workmanship, **EURO-PRO Operating LLC** will repair or replace it free of charge. Proof of purchase date and \$ 9.95 to cover the cost of return shipping and handling must be included. *

Non-durable parts including, without limitation, dust cups and brushes which normally require replacement are specifically excluded from warranty.

The liability of **EURO-PRO Operating LLC** is limited solely to the cost of the repair or replacement of the unit at our option. This warranty does not cover normal wear of parts and does not apply to any unit that has been tampered with or used for commercial purposes. This limited warranty does not cover damage caused by misuse, abuse, negligent handling or damage due to faulty packaging or mishandling in transit. This warranty does not cover damage or defects caused by or resulting from damages from shipping or repairs, service or alterations to the product or any of its parts, which have been performed by a repair person not authorized by **EURO-PRO Operating LLC**.

This warranty is extended to the original purchaser of the unit and excludes all other legal and/or conventional warranties. The responsibility of **EURO-PRO Operating LLC** if any, is limited to the specific obligations expressly assumed by it under the terms of the limited warranty. In no event is **EURO-PRO Operating LLC** liable for incidental or consequential damages of any nature whatsoever. Some states/provinces do not permit the exclusion or limitation of incidental or consequential damages, so the above may not apply to you.

This warranty gives you specific legal rights, and you may also have other rights which vary from state to state or province to province.

***Important: Carefully pack item to avoid damage in shipping. Be sure to include proof of purchase date and to attach tag to item before packing with your name, complete address and phone number with a note giving purchase information, model number and what you believe is the problem with item. We recommend you insure the package (as damage in shipping is not covered by your warranty). Mark the outside of your package "ATTENTION CUSTOMER SERVICE". We are constantly striving to improve our products, therefore the specifications contained herein are subject to change without notice.**



For Canadian Consumers Only OWNERSHIP REGISTRATION CARD

Please fill out and mail the product registration card within ten (10) days of purchase. The registration will enable us to contact you in the unlikely event of a product safety notification. By returning this card you acknowledge to have read and understood the instructions for use, and warnings set forth in the accompanying instructions.

RETURN TO: EURO-PRO Operating LLC, 4400 Bois Franc, St Laurent, Qc, H9S 1A7

UV611TR

Appliance model

Date purchased

Name of store

Owner's name

Address

City

Prov.

Postal Code

Printed in China

IMPORTANT SAFEGUARDS

When using an electrical appliance, basic safety precautions should always be observed, including the following

READ ALL INSTRUCTIONS BEFORE USING YOUR CORDLESS SWEEPER.

WARNING: To reduce the risk of fire, electrical shock, or injury:

1. **Do not** charge this unit outdoors.
2. **Do not** use outdoors or on wet surfaces.
3. **Do not** allow to be used as a toy. Close attention is necessary when used by or near children.
4. Use only as described in this manual. Use only manufacturer's recommended attachments.
5. **Do not** use with damaged cord or plug. Do not use cordless sweeper if it has been dropped, damaged, left outdoors, or dropped in water. Return it to **EURO-PRO Operating LLC** for examination, repair or adjustment.
6. **Do not** abuse the charger cord. Never carry the charger or base by the cord or yank to disconnect from an outlet; instead grasp the charger and pull to disconnect.
7. Keep charger cord away from heated surfaces.
8. This product includes rechargeable nickel cadmium batteries. Batteries must be recycled or disposed of properly. **Do not incinerate batteries or expose to high temperatures**, as they may explode.
9. **Do not** handle plug or appliance with wet hands.
10. **Do not** put any object into openings. **Do not** use with any opening blocked; keep free of dust, lint, hair and anything that may reduce air flow.
11. Keep hair, loose clothing, fingers, and all parts of body away from openings and moving parts.
12. **Do not** pick up anything that is burning or smoking, such as cigarettes, matches, or hot ashes.
13. **Do not** attempt to change accessories while unit is running.
14. Use extra care when cleaning on stairs.
15. **Do not** use to pick up flammable or combustible liquids such as gasoline or use in areas where they may be present.
16. Read and follow all label, operational and marking instructions.
17. **Do not** use charger with an extension cord. Plug charger directly into an electrical outlet. Use charger only in a standard (120V., 60Hz) electrical outlet.
18. **Do not use the cordless sweeper without dust container in place.**
19. Store the cordless sweeper indoors. Store after use to prevent accidents.
20. Leaks from battery cells can occur under extreme conditions. If the liquid, which is 20-35% solution of potassium hydroxide, gets on the skin – wash immediately with soap and water or neutralize with a mild acid such as lemon juice or vinegar. If the liquid gets into the eyes, flush them immediately with clean water for a minimum of 10 minutes and seek medical attention.
21. Use only on dry, indoor surfaces.
22. **Do not** use for any purpose other than described in this user's guide.
23. **Do not** attempt to use the charger with any other product or attempt to charge this product with another charger. **Use only charger model TechWorld AD-0920-UL supplied with this appliance.**
24. The appliance must be disconnected from the supply when removing the battery.

SAVE THESE INSTRUCTIONS FOR HOUSEHOLD USE ONLY

PARTS AND COMPONENTS

1. Upper Handle
2. Telescopic Pole
3. Lower Handle Extension Tube
4. Lower Handle (Shipped inside dust container)
5. Charging Light Indicator
6. On/Off Switch
7. Charging Adapter: Only Use TechWorld AD-0920-UL
(Shipped inside dust container)
8. Dust Container
9. Transparent Brush Cover
10. Rotating Brush
11. Edging Tool
12. Gear Box
13. Sweeper Power Head
14. Speed Indicator Lights
15. Speed Control

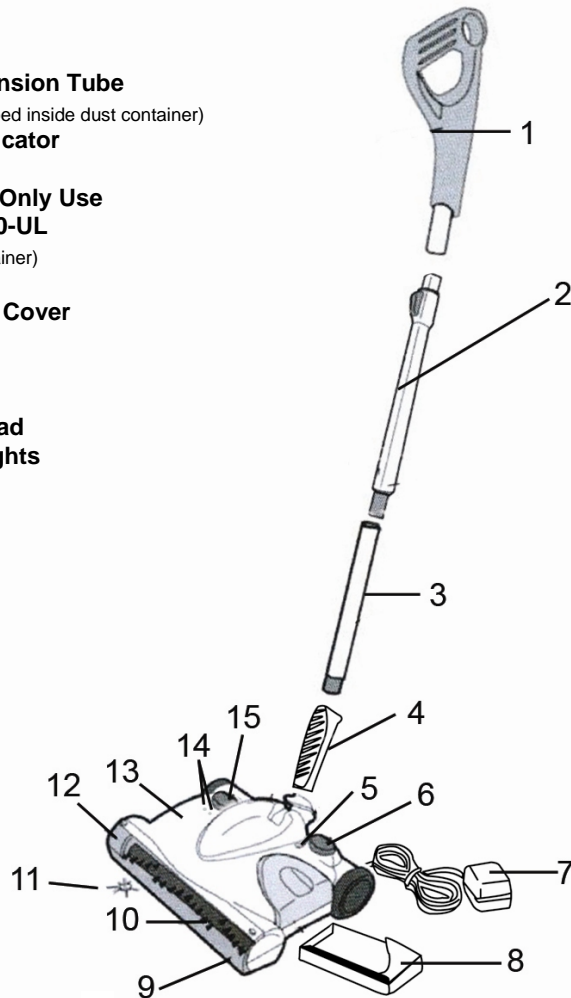

* Illustrations may differ from actual product.

NOTE: The cordless sweeper is shipped with the batteries uncharged. Charging of the unit for 20 hours prior to first use is required. Use replacement battery # XBP610N only.

OPERATING INSTRUCTIONS

TROUBLESHOOTING GUIDE

PROBLEM	POSSIBLE REASON	POSSIBLE SOLUTION
SWEEPER WILL NOT OPERATE	<ol style="list-style-type: none"> 1. Batteries discharged. 2. No power in electrical outlet supplying charging adapter. 3. Unit needs servicing. 4. Battery misplaced. 5. Brush roll jammed. 	<ol style="list-style-type: none"> 1. Charge unit. 2. Check fuse or breaker. Replace fuse/reset breaker. 3. Call Customer Service. 4. Match "+" on battery to compartment "+". 5. Clear any obstruction from the rotating brush. Turn unit off for 10 seconds, then restart.
SWEEPER WILL NOT PICK-UP	<ol style="list-style-type: none"> 1. Dust container is full. 2. Unit needs recharging. 	<ol style="list-style-type: none"> 1. Empty dust container. 2. Charge unit.
DUST ESCAPING FROM SWEEPER	<ol style="list-style-type: none"> 1. Dust container is full. 	<ol style="list-style-type: none"> 1. Empty dust container.
ROTATING BRUSH WILL NOT PICK UP	<ol style="list-style-type: none"> 1. Unit clogged. 2. Dust container is full. 	<ol style="list-style-type: none"> 1. Check for excessive material on brush or in bottom of sweeper. Remove obstruction from brushes and/or sweeper. 2. Empty and clean dust container.
SWEEPER WILL NOT CHARGE	<ol style="list-style-type: none"> 1. Electrical outlet not working. 2. Charging Adapter not working. 3. Batteries no longer functioning. 4. Unit left in "On" position. 	<ol style="list-style-type: none"> 1. Check to ensure outlet is working properly. (Easily checked by plugging in another appliance.) 2. Replace charging adapter. 3. See battery disposal. 4. Press switch to "Off".

OPERATING INSTRUCTIONS

- Slip the belt over the brush bar cap.
- Insert the brush bar into the slot. (Fig. 15)
- Insert the gear box tabs into the tab slots and push down until it clicks into place.
- To replace the squeegee, follow instructions above for removing the gear box and slide the squeegee out from left to right. (Fig. 17)

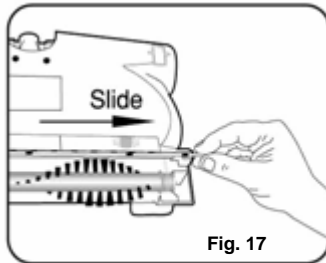

CARE AND MAINTENANCE

To improve the performance and life of your unit, we recommend you do the following:

- Once a month clean the unit with a dry cloth, including the chamber which the dust container fits into. Remove any hair, fiber or other materials that may have built up in the chamber, and on the rotating brush.
- Don't** use abrasive materials to clean the sweeper.
Do not immerse the unit in water.
- Do not** pick up liquids or use on wet floors.
- Do not** use on concrete, tar or similar rough surfaces.
- Don't** pick up pieces of string or fabrics with the sweeper.
- Do not** clean tasseled or frayed carpets with the sweeper.

OPERATING INSTRUCTIONS

ASSEMBLING YOUR CORDLESS SWEEPER

Your cordless sweeper will require very little assembly. You should remove it from the carton and familiarize yourself with all the components listed per the exploded view drawing. (Pg. 2) This will help you in the assembly and operation of your cordless sweeper.

NOTE: The charging adapter and lower handle may be shipped inside the dust cup or the packaging.

- Insert the lower handle - small end - into the sweeper power head. Push until firmly in place. (Fig. 1)

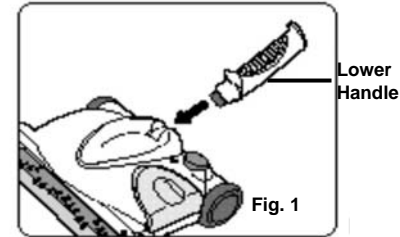

NOTE: The lower handle extension tube has a different plastic insert. This tube should be the first on the assembly.

- Attach the telescopic tube to the extension tube by pushing the plastic insert into the bottom part of the telescopic pole. (Fig. 2a) Push in until the "tab" on the plastic insert snaps into the open slot on the telescopic tube. Push the telescopic tube into the upper handle. (Fig. 2) Insert the extension tube into the lower handle so that the "tab" on the plastic insert snaps into the open slot on the lower handle. (Fig. 2b)

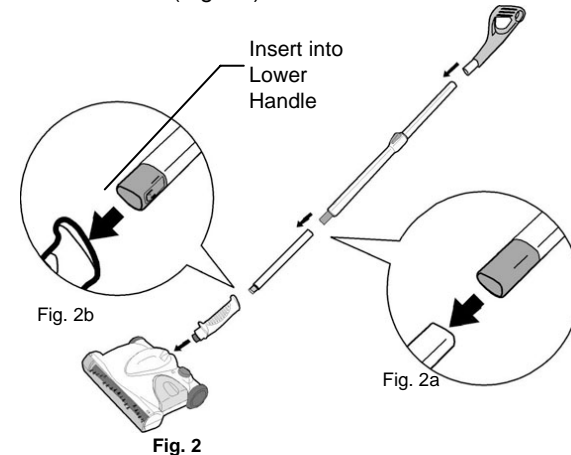

- Place the handle into the upward storage position.

OPERATING INSTRUCTIONS

- The telescopic pole is designed to adjust to the height that is comfortable for all users. To adjust the height, simply push down the release button on the telescoping pole and pull the upper handle to adjust to a comfortable height for using. (Fig. 3)

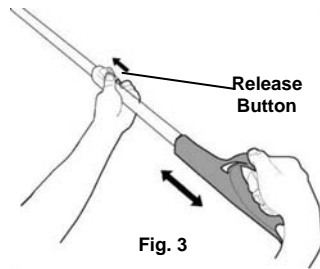

CHARGING INSTRUCTIONS

- Connect the charger plug to the charging jack or hole on the back of the sweeper. Plug the charging adapter into the wall outlet. (120V., 60Hz.) Use only TechWorld Charger AD-0920-UL. (Fig. 4)

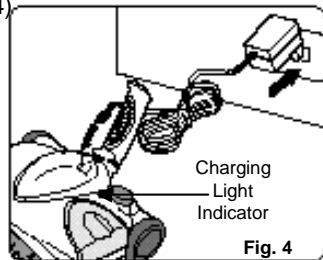

- This cordless sweeper is powered by Ni-Cd batteries. Before first use, they must be charged for a minimum 20 hours.
- When recharging the unit, the "On/Off" switch must be in the "OFF" position.
- The charging light indicator on the top of the sweeper will illuminate to indicate that the sweeper is properly charging.
- To recharge, repeat step #1 above. Charging times will vary depending upon the amount of usage between charging cycles.

NOTE: If, when you place the sweeper to recharge and the charging indicator light does **NOT** illuminate, then press the On/Off button once to turn the sweeper off. The charging indicator light should now light up.

NOTE: Peak performance may only be realized after the unit has been charged and discharged two (2) or three (3) times.

IMPORTANT: To maintain peak performance of your cordless sweeper, it is recommended that the unit be fully discharged, then completely re-charged at least once a month.

CAUTION: Use only the adaptor supplied with the sweeper

CAUTION: Do not clean the sweeper while unit is charging.

OPERATING INSTRUCTIONS

CHANGING THE ROTATING BRUSH, GEAR BOX & SQUEEGEE

- Remove the extension tube handle from the sweeper power head.
- Turn the sweeper power head upside down being careful not to accidentally turn the unit "On".
- Remove the brush cover.
- Push in on the locking tab of the gear box and lift the gear box to remove. (Fig. 13 & Fig 14)

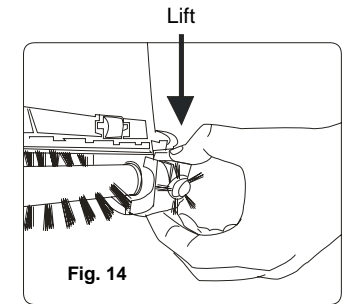
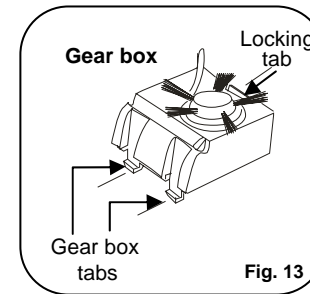

- Lift the brush bar end cap up from the slot. (Fig. 15)

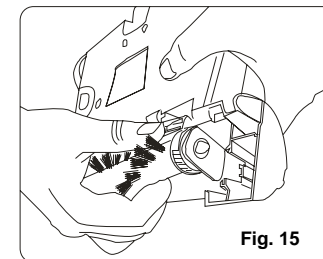

- Pull the brush bar out from the bushing and slip off the belt to remove the brush bar. (Fig. 16)
- Insert the new brush bar by first inserting the brush bar into the bushing on the end opposite the driver belt (Fig. 16)

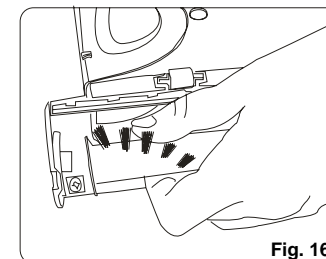

OPERATING INSTRUCTIONS

CLEANING THE DUST CONTAINER

To achieve the best performance, empty the dust container after each use.

1. Pull the dust container straight out from the side. (Fig. 10)

NOTE: Be careful not to accidentally turn the unit "On"

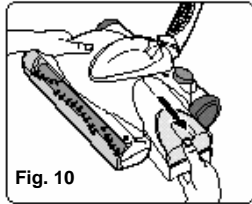

2. Empty dust container contents. (Fig. 11) If desired, you may rinse with water to clean the dust container - but **dry thoroughly** before replacing on the sweeper.

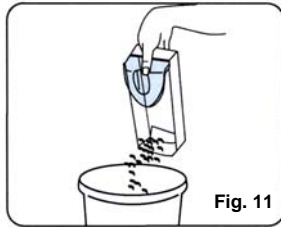

3. Replace dust container on cordless sweeper.
4. Periodically remove the transparent brush cover on the front of the cordless sweeper and remove any build up of lint, hair or fiber on the rotating brush. To remove the cover - grip the cover from the bottom, pull out and upward until the cover unlocks from the side slots and tabs located on the top of the sweeper. Carefully cut away threads or hair with scissors. (Fig. 12)

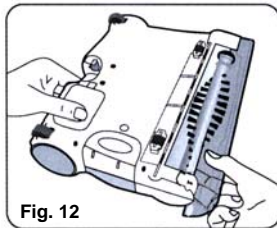

CAUTION: Do not accidentally turn unit on while cleaning.

CAUTION: Any electronic or electrical appliance should not be stored in or exposed to areas of high heat or humidity. Do not store your cordless sweeper close to stoves, radiators, furnaces or in a bathroom or bathing area.

OPERATING INSTRUCTIONS

CAUTION:

- **Do not** attempt to remove the battery pack from the unit to charge it.
- **Never** attempt to throw the battery pack or unit into a fire or incinerate it.
- **Do not** attempt to remove or damage the battery casing.

TO MAXIMIZE THE LIFE OF YOUR NI-CD BATTERIES

1. Charge for a minimum of 20 hours before initial use. Failure to do so will reduce the product's battery life significantly.
2. **Do not** store the unit with the charging adaptor attached and plugged in.
3. Only recharge when the batteries are fully discharged (or as close to fully discharged as possible).
4. **Do not** store in areas of high temperature or humidity.
5. After three (3) months of storage, the product should be fully discharged and then recharged to maximize battery power.
6. Use only the charger supplied with the product. If other chargers are used, the batteries can fail causing damage to the battery, product or personal property.
7. Ni-Cd batteries have a long useful life but at some time they will need to be replaced. To purchase replacement batteries and parts visit www.sharkvac.com.

NOTE: If the product has never been used or has been stored for an extended period of time without use – it will take several complete charge and discharge cycles to realize the full operational time of your product.

BATTERY REMOVAL & DISPOSAL

NOTE: If uncertain as to how to remove your battery pack, we suggest you take your sweeper to a reputable small appliance service technician to have this service performed.

Follow these steps when battery removal is required.

This sweeper is equipped with Ni-Cd batteries and you need to dispose of them properly. When the batteries are no longer good for use, they must be removed from the sweeper for disposal. **Do not** remove the batteries for any reason other than disposal of them.

Call your nearest recycling center for information on the recycling and disposal of Ni-Cd batteries.

WARNING: You must never use ordinary batteries for replacement as these may leak and cause damage. Use only battery pack **XBP610N** provided for replacement.

OPERATING INSTRUCTIONS

Removal of Battery Pack

1. Remove the extension handles and dust cup container.
2. Turn unit over so that the base is facing upwards. Be careful not to turn the unit ON.
3. With a #1 Phillips screwdriver, remove the screw securing the battery pack compartment cover to the unit and place aside. (Fig. 5)

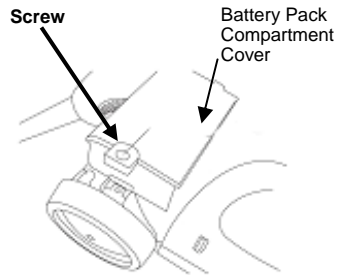

Fig. 5

4. Carefully lift out battery pack and disconnect the terminals. (Fig. 6)

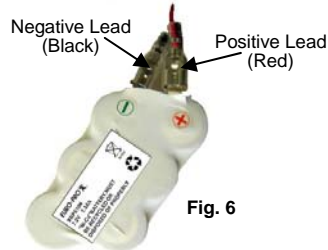

Fig. 6

5. Connect the terminals to the new battery pack taking care to connect the red lead (+) to the positive (larger) connector first and the black lead (-) to the negative (smaller) connector second. (Fig. 7) Place the new battery into the battery compartment.

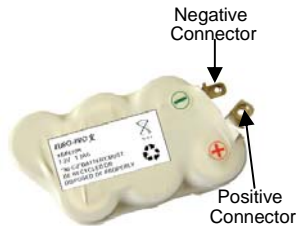

Fig. 7

6. Tuck the wiring inside the battery compartment so that the wiring does not interfere with the battery compartment cover when it is replaced.
7. Re-install the battery compartment cover. Please call customer service at 1 (800) 798-7398 if there are any problems removing batteries.

Do NOT attempt to replace the batteries used in this product with any other type of battery.

CAUTION: This appliance contains Ni-Cd batteries. The batteries must be recycled or disposed of in accordance with local regulations. Please consult your Yellow Pages or local recycling center for more information.

OPERATING INSTRUCTIONS

HOW TO OPERATE YOUR CORDLESS SWEEPER

1. **Before using, please ensure that the cordless sweeper has been initially charged for 20 hours.**
Your cordless sweeper will only operate properly when the batteries are fully charged. Your sweeper will operate for varying lengths of time on a full charge. This will depend upon the type of surface being cleaned. (Longer operating time on bare floors vs. carpets.)
2. Push the On/Off switch to operate the unit. To turn off, press switch again. (Fig. 8)

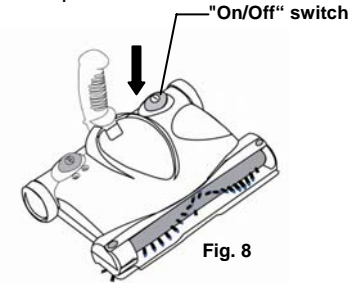

Fig. 8

3. To release the handle to a comfortable position, apply pressure to the top of the sweeper head with your foot while pulling back on the handle. (Fig. 9)

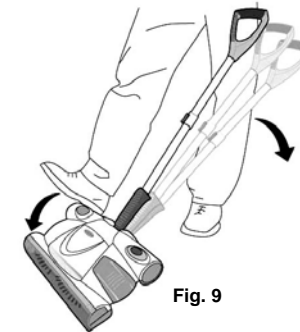

Fig. 9

4. To change the speed of the brush roll, press the speed control button once. One light "On" indicates the unit is on the optimal speed for cleaning hard floors. Two lights "On" indicate the unit is on the optimal speed for cleaning carpets.

ANTI-JAM BRUSH ROLL FEATURE

This feature protects your unit's motor from damage due to overheating, that may be caused by the rotating brush gets jammed or tangled in something. If the rotating brush becomes overloaded it will stop turning and both speed indicator lights will remain lit at the same time. To reset the unit:

1. Press On/Off switch.
2. Remove the transparent brush cover from the sweeper power head to remove any build up of lint, hair or fiber on the rotating brushes.
3. Wait for 10 seconds to allow the unit to cool down.
4. Press "On/Off switch again, the unit should restart.

Free Manuals Download Website

<http://myh66.com>

<http://usermanuals.us>

<http://www.somanuals.com>

<http://www.4manuals.cc>

<http://www.manual-lib.com>

<http://www.404manual.com>

<http://www.luxmanual.com>

<http://aubethermostatmanual.com>

Golf course search by state

<http://golfingnear.com>

Email search by domain

<http://emailbydomain.com>

Auto manuals search

<http://auto.somanuals.com>

TV manuals search

<http://tv.somanuals.com>