

# **Shark<sup>®</sup>**

***Hand Vacuum With Motorized Brush***

## **OWNER'S MANUAL**

**Model V1510**

120V., 60Hz., 6.67 Amps



**EURO-PRO Operating LLC**  
Boston, MA, 02465  
Tel.: 1 (800) 798-7398  
[www.sharkvac.com](http://www.sharkvac.com)

**EURO-PRO** 

# IMPORTANT SAFETY INSTRUCTIONS

When using your **SHARK Hand Vacuum with Motorized Brush**, basic safety precautions should always be observed, including the following:

1. Read all instructions before using your **SHARK** hand vacuum.
2. Use the system only for its intended use.
3. To protect against a risk of electric shock, do not immerse any part of the system in water or other liquids.
4. Never yank cord to disconnect from outlet; instead, grasp plug and pull to disconnect.
5. **Do not** allow cord to touch hot surfaces.
6. **Do not** run appliance over cord.
7. **Do not** operate the system with a damaged cord or plug, or if the appliance or any other part of the system has been dropped or damaged. To avoid the risk of electric shock, do not disassemble or attempt to repair the hand vacuum. Return the system to **EURO-PRO Operating LLC** (see warranty) for examination and repair. Incorrect re-assembly or repair can cause a risk of electrical shock or injury to persons when the hand vacuum is used.
8. Close supervision is necessary for any appliance being used by or near children. Do not leave the system unattended while connected.
9. Keep hair, loose clothing, fingers and all parts of body away from opening and moving parts.
10. **Do not** use to pick up flammable or combustible liquids such as gasoline or use in areas where they may be present.
11. **Do not** pick up anything that is burning or smoking such as cigarettes, matches or hot ashes.
12. Use extra care when cleaning on stairs.
13. **Do not** use the hand vacuum without the dust cup filter in place.
14. This appliance is intended only for household use. Follow all user instructions in this manual.

## To reduce the risk of fire, electric shock, or injury:

- **Do not** leave the hand vacuum plugged in when unattended. Unplug the electrical cord when not in use and before servicing.
- **Do not** allow the unit to be used as a toy. Close attention is necessary when used by or near children, pets or plants.
- Use only as described in this manual. Use only manufacturer's recommended accessories.
- **Do not** pull cord, use cord as a handle, close a door on cord, or pull cord around sharp edges or corners. Keep cord away from heated surfaces.
- Use **only** extension cords UL-rated or cUL at 15 amperes. extension cords rated for less amperage may overheat. Care should be taken to arrange the cord so that the cord cannot be pulled or tripped over.
- Turn off all controls as applicable before unplugging from electrical outlet.
- **Do not** unplug by pulling on cord. To unplug, grasp the plug, not the cord.
- **Do not** handle plug or hand vacuum with wet hands or operate without shoes.
- **Do not** put any objects into openings. Do not use with any opening blocked. Keep free of dust, lint, hair and anything else that may reduce air flow.
- Store your appliance indoors in a cool, dry area.
- Keep your work area well lit.
- **Do not** immerse the hand vacuum into water or other liquids.
- Keep end of hose and other openings away from your face and body.
- Use only on dry surfaces.
- Using improper voltage may result in damage to the motor and possible injury to the user. Correct voltage is listed on rating label.

## SAVE THESE INSTRUCTIONS For Household Use Only

**WARNING:** To reduce the risk of electric shock, this appliance has a polarized plug (one blade is wider than the other). This plug will fit in a polarized outlet only one way. If the plug does not fit fully in the outlet, reverse the plug. If it still does not fit, contact a qualified electrician to install the proper outlet. Do not modify the plug in any way.

## GETTING TO KNOW YOUR HAND VACUUM

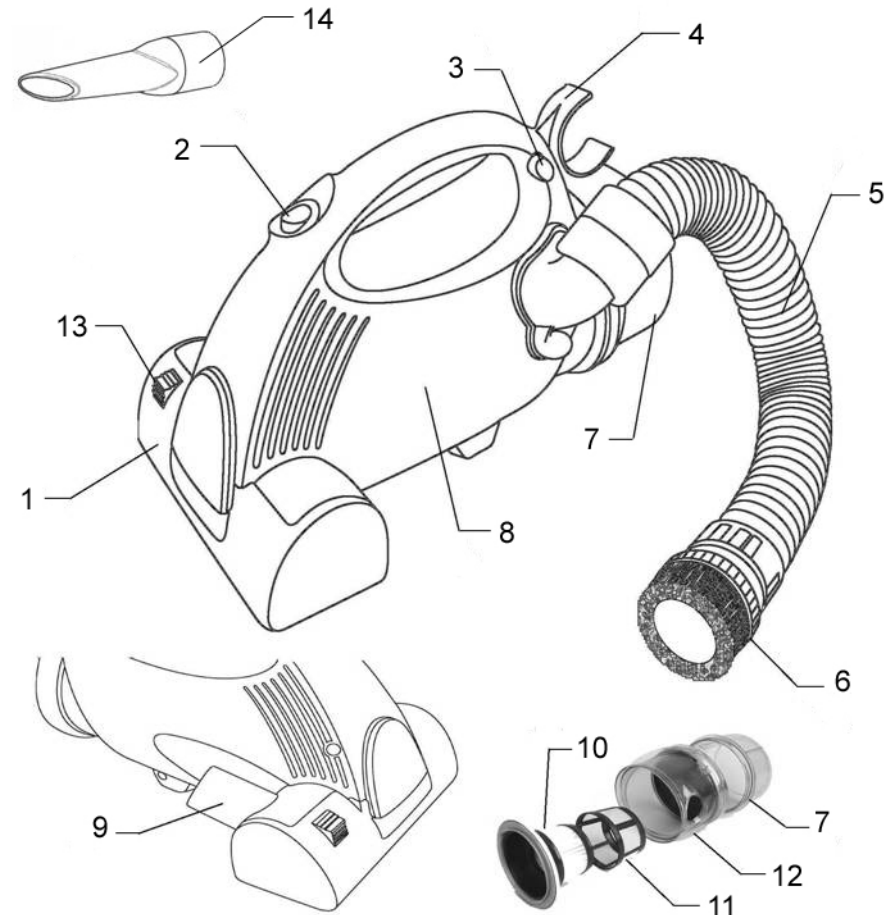

1. Brush Safety Cover
2. On/Off Switch
3. Dust Cup Release Button
4. Hose Clip
5. Flexible Hose
6. Dusting Brush
7. Dust Cup
8. Main Unit
9. Brush Chamber Exhaust Port
10. Hepa Filter
11. Debris Screen
12. Filter Chamber
13. Cover Release Button
14. Crevice Tool

### Technical Specifications

Voltage: 120V., 60Hz.  
Power: 6.67 Amps, 800 Watts

**\*Illustrations may differ from actual product**

## PRECAUTIONARY MEASURES

**IMPORTANT:** If the suction opening of the hose is **BLOCKED**, switch off the vacuum cleaner and remove the blocking substance before you start the unit again.

1. Do not operate the vacuum cleaner too close to heaters or radiators.



2. Before inserting the power plug into the wall outlet, make sure that your hands are dry.

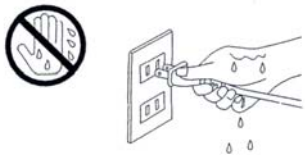

3. Before you start vacuuming, make sure to remove large or sharp objects that might damage the HEPA Filter.

4. When pulling out the power plug from the wall outlet, pull the plug not the power cord.

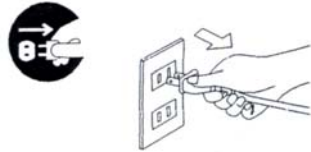

5. Do not pick up anything that is burning or smoking such as cigarettes, matches or hot ashes.

6. Do not use without HEPA filter in place.

7. Do not bend, trample or pull the hose by force. Do not operate with a damaged hose.

8. When vacuuming fine dust particles such as gyproc dust, flour or any other fine dust, empty the dust cup and "TAPCLEAN" the dust cup filter frequently to avoid over heating the motor.

## OPERATING INSTRUCTIONS

**WARNING:** Always unplug from electrical outlet before opening the dust cup (container).

**Note:** HEPA dust cup filter must be used when operating the hand vacuum.

### Using The Unit As A Hand Vacuum

1. Insert the dusting brush/hose connector into the brush chamber exhaust port. Lock the flexible hose in place by clipping the hose into the hose holder. (Fig. 1)

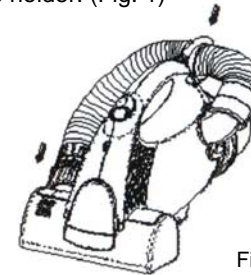

Fig. 1

### Cleaning With the Hose

To use the hand vacuum with only the hose and the dusting brush or crevice tool:

1. Rotate the brush cover by pushing on the brush cover release button until it clicks in place. (Fig. 2)
2. Remove the flexible hose from the brush chamber exhaust port and take the hose out from the hose holder. (Fig. 3)



Fig. 2

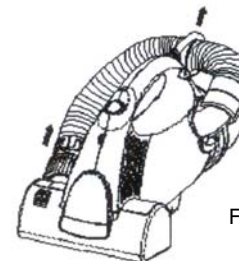

Fig. 3

3. To use the flexible hose with the dusting brush, hold the hose in one hand and with the other, pull out the dusting brush and turn clockwise to lock in place. (Fig. 4)

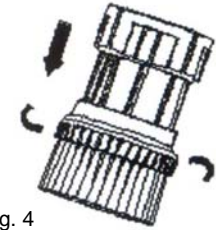

Fig. 4

4. To use the flexible hose with the crevice tool, make sure that the brush is in the storage position and insert the crevice tool into the opening of the hose. (Fig. 5)

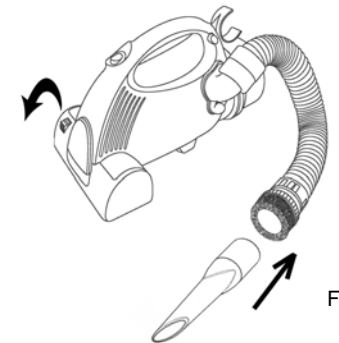

Fig. 5

**CAUTION:** The hand vacuum is a very powerful unit. Make sure that you hold it firmly, otherwise it can slip out of your hand and cause injury.

## OPERATING INSTRUCTIONS

### Cleaning & Changing the HEPA Dust Cup Filter

**WARNING:** Always unplug the unit from electrical outlet before opening the Dust Cup (container).

**IMPORTANT:** Do **NOT** use the HEPA filter cartridge without the debris screen in place.

**WARNING:** After each Use - Always remove the filter debris screen from the HEPA dust cup filter, then vigorously "TapClean" HEPA filter until no more dust can be removed.

**IMPORTANT, Please Note :** The "TapClean" HEPA dust cup filter & debris screen will stop most of the tiniest dust particles and airborne allergens from re-entering the air you breathe. Because of this incredible filtration performance, the HEPA dust cup filter will quickly accumulate, inside the white filter folds, many fine dust particles that are difficult to see but which will eventually block or reduce your suction power - if not cleaned properly. Clean the HEPA filter and debris screen after each use as described in this section.

1. To remove the dust cup (container), hold the unit in the upright position to prevent the dust from falling out of the dust cup. (Fig. 6)



Fig. 6

2. To open the dust cup (container), push button and remove the dust cup (container). (fig. 7)

Dust cup release button

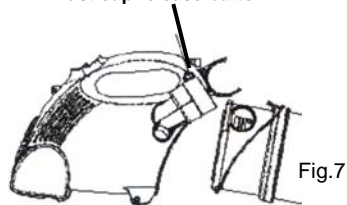

Fig.7

3. Rotate the lower dust cup clockwise to separate it from the filter chamber. Empty and clean the dust cup. (Fig. 8)

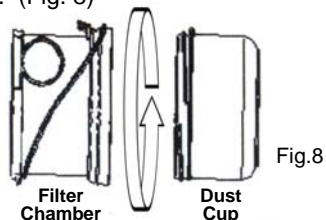

Fig.8

4. Remove the HEPA filter from the filter chamber. (Fig. 9)

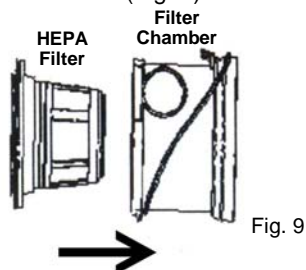

Fig. 9

5. Separate the debris screen from the HEPA filter cartridge by grasping the debris screen with one hand and the filter frame with the other and pull apart. (Fig. 10)

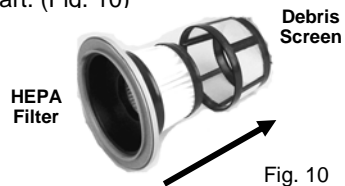

Fig. 10

## OPERATING INSTRUCTIONS

6. Vigorously "TapClean" the HEPA dust cup filter on a hard surface until no more dust is observed falling out from between the pleats of the filter. (Fig. 11)



Fig. 11

7. "TapClean" the debris screen or rinse under a faucet until clean. (Fig. 12) Remember that the debris screen must be completely dry before reinstalling in the vacuum.

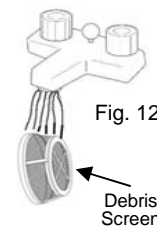

Fig. 12

8. Replace the debris screen on the HEPA dust cup filter and reinstall filter assembly in the vacuum. (Not shown)

**PLEASE NOTE:** The white pleated filter material in the HEPA dust cup filter will discolor over time -This is NORMAL and will NOT affect the performance of the filter. If the HEPA dust cup filter is properly "TapCleaned" after each use and suction does not return to 100%, then we suggest that the HEPA filter be "TapCleaned" vigorously until no more dust can be removed, then rinsed under the faucet and allowed to dry for 24 hours before refitting into the vacuum. (Fig. A) **This should be done once a month or when suction appears reduced.**

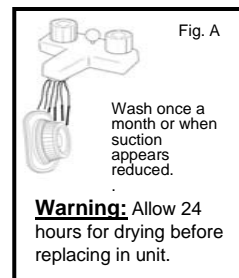

Fig. A

Wash once a month or when suction appears reduced.

**Warning:** Allow 24 hours for drying before replacing in unit.

**CAUTION:** The suction hole must be open and free of any obstructions at all times. Otherwise, the motor will overheat and could become damaged.

### Motor Thermostat

**IMPORTANT:** This unit is equipped with a motor protective thermostat. If for some reason the vacuum cleaner should overheat, the thermostat will automatically turn the unit off. Should this occur:

- Push the On/Off button once.
- Disconnect the plug from the power source.
- Check the source of overheating problem. (i.e. clogged hose or filter)
- If clogged hose or filter is found, unplug the hose and replace the filters.
- Wait at least 45 minutes before attempting to reuse the vacuum.
- After unit has cooled down for 45 minutes, plug in the cleaner and push the On/Off button. The vacuum should start again.
- If the vacuum still does not start, contact customer service at 1 (800) 798-7398.

## TROUBLE SHOOTING GUIDE

PROBLEM	POSSIBLE REASON	POSSIBLE SOLUTION
HAND VACUUM WILL NOT OPERATE	<ol style="list-style-type: none"> <li>1. Power cord not firmly plugged into outlet.</li> <li>2. No power in wall outlet.</li> <li>3. Needs servicing.</li> <li>4. Thermostat has tripped.</li> </ol>	<ol style="list-style-type: none"> <li>1. Plug unit in firmly.</li> <li>2. Check fuse or breaker. Replace fuse/reset breaker. Call 1 (800) 798-7398.</li> <li>3. Call 1 (800) 798-7398.</li> <li>4. Turn the unit off and unplug from outlet.</li> </ol>
HAND VACUUM WILL NOT PICK-UP OR SUCTION POWER IS WEAK	<ol style="list-style-type: none"> <li>1. Dust cup is full.</li> <li>2. Unit clogged.</li> <li>3. HEPA Dust Cup Filter needs cleaning or replacing.</li> </ol>	<ol style="list-style-type: none"> <li>1. Allow unit to cool down, then Restart. Empty dust cup – (see page 5).</li> <li>2. Turn unit off and unplug from wall outlet. Remove HEPA Dust Cup Filter and check for object(s) in air duct and remove.</li> <li>3. Clean or replace HEPA Dust Cup Filter. (see page 5)</li> </ol>
DUST ESCAPING FROM HAND VACUUM	<ol style="list-style-type: none"> <li>1. Dust cup is full.</li> <li>2. HEPA Dust Cup Filter is not installed correctly.</li> <li>3. There is a puncture/hole in HEPA Dust Cup Filter.</li> </ol>	<ol style="list-style-type: none"> <li>1. Empty dust cup.</li> <li>2. Review HEPA Dust Cup Filter instructions. (see page 5)</li> <li>3. Replace HEPA dust cup filter. (see page 5)</li> </ol>
HAND VACUUM HOSE OR BRUSHES WILL NOT PICK-UP	<ol style="list-style-type: none"> <li>1. Hose clogged.</li> <li>2. Dust cup is full.</li> </ol>	<ol style="list-style-type: none"> <li>1. Remove hose and/or brushes. Remove obstruction from hose.</li> <li>2. Empty and clean dust cup.</li> </ol>

## ORDERING REPLACEMENT DUST CUP FILTERS

### FOR REPLACEMENT FILTER INFORMATION for Model V1510

Call: 1 (800) 798-7398  
Monday to Friday 8:30 A.M. - 5:00 P.M. Eastern Standard Time  
Or visit our website:  
[www.sharkvac.com](http://www.sharkvac.com)

Item	Part #
Replacement HEPA Filter	XF1510

### For Technical Support for Model V1510

Call: 1 (800) 798-7398  
Monday to Friday 8:30 A.M. - 5:00 P.M. Eastern Standard Time

#### **Please Note:**

The HEPA Dust Cup Filter is washable. It should, however, be replaced every six (6) months to ensure peak performance of your vacuum.

#### **Important:**

Make sure that **HEPA** filter is completely dry before re-installing back in the hand vacuum.



## ONE (1) YEAR LIMITED WARRANTY

**EURO-PRO Operating LLC** warrants this product to be free from defects in material and workmanship for a period of one (1) year from the date of the original purchase, when utilized for normal household use, subject to the following conditions, exclusions and exceptions.

If your appliance fails to operate properly while in use under normal household conditions within the warranty period, return the complete appliance and accessories. For Customer Service support, call 1 (800) 798-7398 or visit our website at [www.sharkvac.com](http://www.sharkvac.com). If the appliance is found to be defective in material or workmanship, **EURO-PRO Operating LLC** will repair or replace it free of charge. Proof of purchase date and \$ 9.95 to cover the cost of return shipping and handling must be included. \*

Non-durable parts including, without limitation, dust cups, filters and brushes which normally require replacement are specifically excluded from warranty.

The liability of **EURO-PRO Operating LLC** is limited solely to the cost of the repair or replacement of the unit at our option. This warranty does not cover normal wear of parts and does not apply to any unit that has been tampered with or used for commercial purposes. This limited warranty does not cover damage caused by misuse, abuse, negligent handling or damage due to faulty packaging or mishandling in transit. This warranty does not cover damage or defects caused by or resulting from damages from shipping or repairs, service or alterations to the product or any of its parts, which have been performed by a repair person not authorized by **EURO-PRO Operating LLC**.

This warranty is extended to the original purchaser of the unit and excludes all other legal and/or conventional warranties. The responsibility of **EURO-PRO Operating LLC** if any, is limited to the specific obligations expressly assumed by it under the terms of the limited warranty. In no event is **EURO-PRO Operating LLC** liable for incidental or consequential damages of any nature whatsoever. Some states/provinces do not permit the exclusion or limitation of incidental or consequential damages, so the above may not apply to you. This warranty gives you specific legal rights, and you may also have other rights which vary from state to state.

**\*Important: Carefully pack item to avoid damage in shipping. Be sure to include proof of purchase and to attach a tag to item before packing with your name, complete address and phone number with a note giving purchase information, model number and what you believe is the problem with item. We recommend you insure the package (as damage in shipping is not covered by your warranty). Mark the outside of your package "ATTENTION CUSTOMER SERVICE". We are constantly striving to improve our products, therefore the specifications contained herein are subject to change without notice.**

## Free Manuals Download Website

<http://myh66.com>

<http://usermanuals.us>

<http://www.somanuals.com>

<http://www.4manuals.cc>

<http://www.manual-lib.com>

<http://www.404manual.com>

<http://www.luxmanual.com>

<http://aubethermostatmanual.com>

Golf course search by state

<http://golfingnear.com>

Email search by domain

<http://emailbydomain.com>

Auto manuals search

<http://auto.somanuals.com>

TV manuals search

<http://tv.somanuals.com>