

SHARP®

MODEL

UX-B800SE

FACSIMILE

OPERATION MANUAL

WARNING - FCC Regulations state that any unauthorized changes or modifications to this equipment not expressly approved by the manufacturer could void the user's authority to operate this equipment.

Note: This equipment has been tested and found to comply with the limits for a Class B digital device, pursuant to Part 15 of the FCC Rules. These limits are designed to provide reasonable protection against harmful interference in a residential installation. This equipment generates, uses and can radiate radio frequency energy and, if not installed and used in accordance with the instructions, may cause harmful interference to radio communications. However, there is no guarantee that interference will not occur in a particular installation. If this equipment does cause harmful interference to radio or television reception, which can be determined by turning the equipment off and on, the user is encouraged to try to correct the interference by one or more of the following measures:

- Reorient or relocate the receiving antenna.
- Increase the separation between the equipment and the receiver.
- Connect the equipment into an outlet on a circuit different from that to which the receiver is connected.
- Consult the dealer or an experienced radio/TV technician for help.

ABOUT THE TELEPHONE CONSUMER PROTECTION ACT OF 1991

"The Telephone Consumer Protection Act of 1991 makes it unlawful for any person to use a computer or other electronic device to send any message via a telephone facsimile machine unless such message clearly contains in a margin at the top or bottom of each transmitted page or on the first page of the transmission the following information:

- (1) The date and time of transmission.
- (2) Identification of either the business, business entity or individual sending the message.
- (3) Telephone number of either the sending machine, business, business entity or individual.

In order to program this information into your facsimile machine, please refer to the appropriate instructions in the operation manual."

Declaration of Conformity

SHARP FACSIMILE, UX-B800SE

This device complies with Part 15 of the FCC rules. Operation is subject to the following two conditions:

- (1) This device may not cause harmful interference, and (2) this device must accept any interference received, including interference that may cause undesired operation.

Responsible Party:

SHARP ELECTRONICS CORPORATION

Sharp Plaza, Mahwah, New Jersey 07430-1163

TEL: 800-237-4277



As an ENERGY STAR[®] partner, SHARP has determined that this product meets the ENERGY STAR[®] guidelines for energy efficiency.

Trademark information

All other company names and product names appearing in this manual are the trademarks of their respective owners.

Table of Contents

Introduction	2	Reception to Memory	33
A Look at the Operation Panel	5	5. Making Copies	34
1. Installation	7	6. Special Functions	35
Unpacking Checklist	7	Broadcasting	35
Setup	7	Caller ID (Requires Service)	37
Loading Paper	8	Distinctive Ring (Requires Service)	39
Connecting the Power Cord	9	Blocking Unwanted Faxes	40
Installing the Print Cartridge	9	Duplex Scanning	40
Connecting the Phone Line	11	Receiving Faxes to E-mail	41
Name and Fax Number	11	Secure Receive	43
Setting the Date and Time	12	7. Option Settings and Print Settings	45
Setting the Reception Mode	13	8. Printing Lists	50
Volume Adjustment	13	Transaction Report	51
2. Fax to E-mail	14	9. Maintenance	52
Connecting the Machine	14	Cleaning the Machine	52
E-mail Settings	17	Improving Print Quality	53
Storing E-mail Addresses	19	10. Troubleshooting	56
Fax to E-mail Transmission	20	Problems and Solutions	56
Network Settings	23	Messages and Signals	59
3. Sending Faxes	24	Clearing Paper Jams	62
Transmittable Documents	24	Ordering Parts	63
Loading the Document	24	Quick Reference Guide	68
Resolution and Contrast	25	Guía de referencia rápida	69
Sending a Fax: Normal Dialing	26	Index	70
Sending a Fax: Auto Dialing	27		
Batch Page Numbering	31		
Sending a Fax From Memory	31		
4. Receiving Faxes	32		
Using AUTO Mode	32		
Using MANUAL Mode	32		
TEL/FAX Mode	33		

Introduction

Specifications

Print cartridge yield* **	Replacement cartridge: SHARP UX-C80B Ink Save mode ON: Approx. 800 letter pages Ink Save mode OFF: Approx. 480 letter pages (The initial cartridge has the same yield as the above replacement cartridge.)
Paper tray capacity	Letter: Approx. 200 sheets (20-lb. copier paper at room temperature; maximum stack height should not be higher than the line on the tray) Legal: 100 sheets Recommended paper weight: 20-lb. Copy Bond
Recording system	Thermal inkjet
Print resolution	600 × 600 dpi
Effective printing width	8.0" (203 mm) max.
Fax to E-mail	Yes; requires an Internet connection and a router, switch, or hub to connect the machine. LAN cable (10Base-T/100Base-TX straight-through cable) must be purchased separately.
File formats	Tiff (G4), PDF (G4)
Memory capacity**	Approximately 100 average pages
Modem speed	14,400 bps with auto fallback to lower speeds.
Transmission time**	Approx. 6 seconds
Compatibility	ITU-T (CCITT) G3 mode
Compression scheme	MR, MH, MMR
Storable transmission destinations	Rapid Keys: 36 A, B, C keys: 3 (e-mail only) Speed Dial numbers: 63
Telephone function	Yes (cannot be used if power fails)
Effective scanning width	8.2" (208 mm) max.

*Ink Save mode is initially turned off. To turn on Ink Save mode, see pages 45 and 49.

**Based on Sharp Standard Chart at standard resolution, excluding time for protocol signals (i.e., ITU-T phase C time only).

Applicable telephone line	Public switched telephone network
Reception modes	AUTO, MANUAL, TEL/FAX
Automatic document feeder	Letter/A4: 20 sheets max. (20-lb. paper; temperature: 64 - 82°F (18 - 28°C); humidity: 45 - 65% RH) Legal: 5 sheets max.
Input document size	Automatic feeding: Width: 5.8" to 8.5" (148 to 216 mm) Length (20 sheets): 5.5" to 11" (140 to 279 mm) Length (5 sheets): 5.5" to 14" (140 to 356 mm) Manual feeding: Width: 2.75" to 8.5" (70 to 216 mm) Length: 5.5" to 14" (140 to 356 mm)
Scanning Resolution	Standard: 203 x 98 dpi Fine: 203 x 196 dpi Super fine: 203 x 391 dpi Halftone: 203 x 196 dpi
Halftone (grayscale)	64 levels
Contrast control	Automatic/Dark selectable
Copy function	Single/Multi/Sort (99 copies/page)
Display	LCD display, 20 digits x 2 lines
Power requirements	120 V AC, 60 Hz
Power consumption	Standby: 6.0 W, Maximum: 40 W
Operating temperature	60 - 90°F (15 - 32°C)
Humidity	25 - 80% RH
Dimensions (without attachments)	Width: 15.0" (380 mm) Depth: 11.0" (280 mm) Height: 6.1" (156 mm)
Weight (without attachments)	Approx. 9.7 lbs. (4.4 kg)

As a part of our policy of continuous improvement, SHARP reserves the right to make design and specification changes for product improvement without prior notice. The performance specification figures indicated are nominal values of production units. There may be some deviations from these values in individual units.

Important: This machine is not designed for use on a line which has call waiting, call forwarding, or certain other special services offered by your telephone company (errors may occur during transmission and reception of faxes).
This machine is not compatible with digital telephone systems.

Important safety information

Do not disassemble this machine or attempt any procedures not described in this manual. Refer all servicing to qualified service personnel.

Do not install or use the machine near water, or when you are wet. For example, do not use the machine near a bath tub, wash bowl, kitchen sink or laundry tub, in a wet basement, or near a swimming pool. Do not spill any liquids on the machine.

Unplug the machine from the power outlet and telephone jack and consult a qualified service representative if any of the following situations occur:

- Liquid has been spilled into the machine or the machine has been exposed to rain or water.
- The machine produces odors, smoke, or unusual noises.
- The power cord is frayed or damaged.
- The machine has been dropped or the housing damaged.

Do not allow anything to rest on the power cord, and do not install the machine where people may walk on the power cord.

This machine must only be connected to a 120 V, 60 Hz, grounded (3-prong) outlet. Connecting it to any other kind of outlet will damage the machine and invalidate the warranty.

Never insert objects of any kind into slots or openings on the machine. This could create a risk of fire or electric shock. If an object falls into the machine that you cannot remove, unplug the machine and consult a qualified service representative.

Do not place this machine on an unstable cart, stand or table. The machine could be seriously damaged if it falls.

Never install telephone wiring during a lightning storm.

Never install telephone jacks in wet locations unless the jack is specifically designed for wet locations.

Never touch bare telephone wires or terminals unless the telephone line has been disconnected at the network interface.

Use caution when installing or modifying telephone lines.

Avoid using a telephone (other than a cordless type) during an electrical storm. There may be a remote risk of electric shock from lightning.

Do not use a telephone to report a gas leak in the vicinity of the leak.

The power outlet must be installed near the equipment and must be easily accessible.

A Look at the Operation Panel

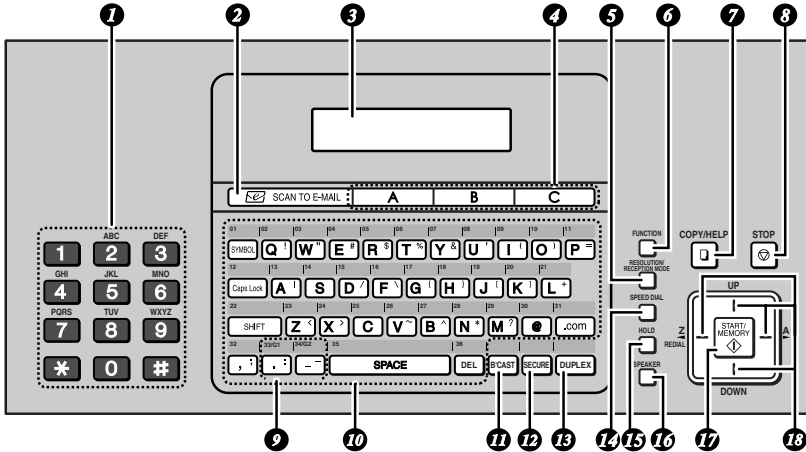

Note: Affix the Rapid Key labels as shown above.

- 1 Number keys:** Use to dial numbers.
- 2 SCAN TO E-MAIL key:** Press to send a document to an e-mail recipient.
- 3 Display:** This displays messages to help you operate the machine.
- 4 A, B, C keys:** An e-mail address can be stored in each key for one-touch selection (p. 19).
- 5 RESOLUTION/RECEPTION key**
When a document is in the feeder, press to adjust the scanning resolution (p. 25). At any other time, press to select the reception mode (p. 13).
- 6 FUNCTION key:** Press this key followed by the arrow keys to select special functions and settings.
- 7 COPY/HELP key**
When a document is in the feeder, press to make a copy (p. 34). At any other time, press to print the Help List.
- 8 STOP key:** Press to cancel an operation before it is completed.
- 9 Group Keys:** Multiple fax or e-mail destinations can be stored in each key for one-touch selection (p. 36).
- 10 Rapid Keys / letter keys:** A fax number or e-mail address can be stored in each of these keys for one-touch selection (attach the Rapid Key labels). When entering text, the keys are used as letter keys.
- 11 BROADCAST key:** Press to send to multiple fax or e-mail destinations (p. 35).
- 12 SECURE key:** Press to use the fax secure receive function (p. 43).
- 13 DUPLEX key:** Use to scan two-sided documents for transmission and copying (p. 40).
- 14 SPEED DIAL key:** Press to select a fax or e-mail destination stored in a 2-digit Speed Dial number (pp. 19, 27).

- 15 HOLD key:** Press to put a phone call on hold (p. 33).
- 16 SPEAKER key:** Press to listen to the line and fax tones through the speaker when faxing (p. 26).
Note: **This is not a speakerphone.** It cannot be used for speaking.

- 17 START/MEMORY key:** Press after dialing to send a fax (p. 26). Press before dialing to send a fax through memory (p. 31). Press in the date and time display to show the percentage of memory currently used.



- 18 Arrow keys:** Use to scroll through and select settings, and to search for stored destinations (pp. 21, 29).

Letter keys

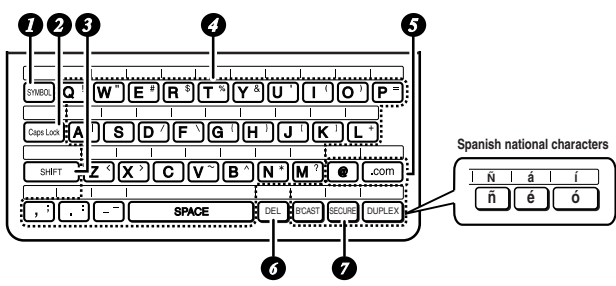
Use these keys when the display prompts you to enter a name, e-mail address, or other text.



- 1 SYMBOL key:** Press to enter a symbol (the character appearing on the right side of each letter key). Press again to return to normal letter entry mode.
- 2 Caps Lock key:** Press to enter upper case letters. Press again to return to lower case letter entry.
- 3 SHIFT key:** Hold down to temporarily change case.
- 4 Letter keys:** Use to enter letters.
- 5 @key, .com key:** Press to conveniently enter “@” and “.com” when entering an e-mail address.

- 6 DEL key:** Press to delete the character marked by the cursor. When the cursor is to the right of a line of text, press to backspace and clear characters. (The cursor can be moved by pressing  or .) To delete all entered characters, hold down until all characters are cleared.

- 7 Spanish national characters:** These can be entered when the display language is set to Spanish. To enter the character indicated inside the key, press the key. To enter the character indicated above the key, press the key while holding down the **SHIFT** key.

1. Installation

Unpacking Checklist

Paper Document Received Handset
tray exit tray document cord
tray Handset

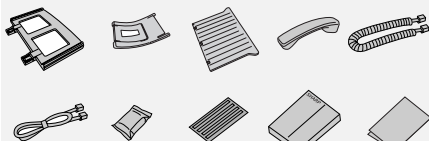

Phone Print Rapid Manual Setup
line cartridge Key labels cord

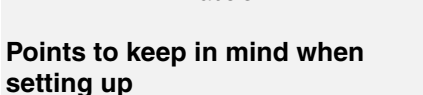

Points to keep in mind when setting up

- ◆ Do not place the machine in direct sunlight.
- ◆ Do not place the machine near heaters or air conditioners.
- ◆ Keep dust away from the machine.
- ◆ Keep the area around the machine clear.

About condensation

If the machine is moved from a cold to a warm place, condensation may form on the scanning glass, preventing proper document scanning. To remove the condensation, turn on the power and wait approximately two hours before using the machine.

Setup

Remove the packing tape

- 1 Open the cover (1) and remove the tape (2). (Do not install the print cartridge yet.)

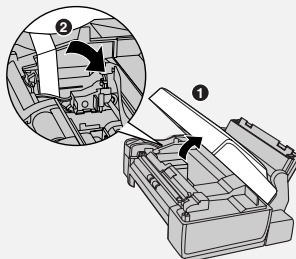

- 2 Close the cover.

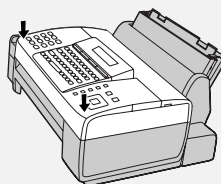

Connect the handset

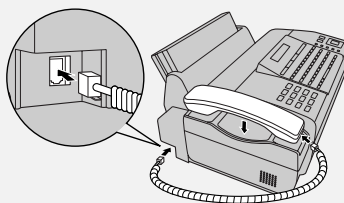

Attach the trays

Attach the received document tray

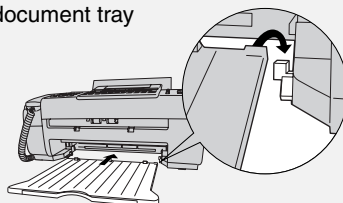

Loading Paper

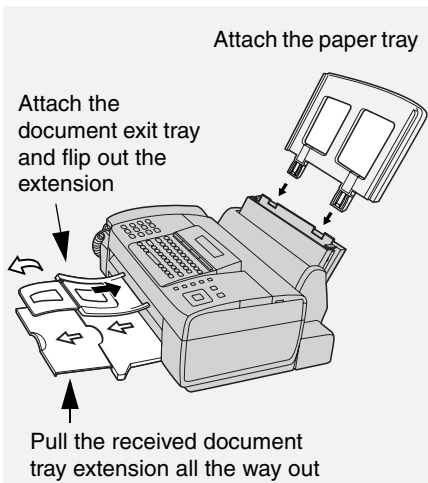

Loading Paper

Letter or legal size paper can be loaded.

Maximum number of sheets

(20-lb. copy bond paper at room temperature)

Letter: Approx. 200 sheets
(maximum stack height should not be higher than the line on the tray)

Legal size: 100 sheets

- 1 Fan the paper, and then tap the edges against a flat surface to even the stack.

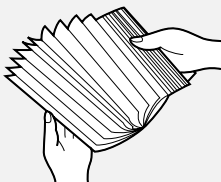

- 2 Pull the paper plate forward and insert the stack of paper into the tray, **print side up**.

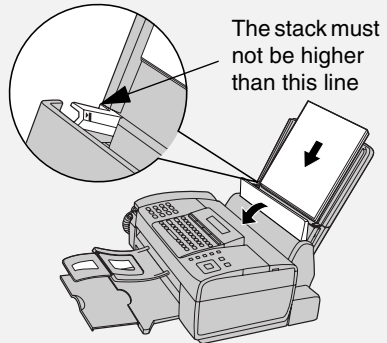

- If paper remains in the tray, take it out and combine it into a single stack with the new paper.
- Printing on the reverse side of the paper may result in poor print quality.
- Do not use paper that has already been printed on or is curled.
- Remove received faxes and other printed output before about 50 sheets (10 legal-size sheets) accumulate in the received document tray (otherwise the sheets may scatter).

If you loaded legal size paper...

You must change the "PAPER SIZE" setting to "LEGAL" (pp. 45 and 49). (Before changing the setting, plug in the power cord and install a print cartridge as explained in the following sections.)

Connecting the Power Cord

If at any time the display shows [**ADD PAPER &**] / [**PRESS START KEY**], check the paper tray. If the tray is empty, add paper. If there is paper in the tray, take it out and then reinsert it.

When finished, press  .

Connecting the Power Cord

Plug the power cord into a 120 V, 60 Hz, grounded AC (3-prong) outlet.

Caution! Do not plug the power cord into any other kind of outlet. This will damage the machine and is not covered under the warranty.

Caution! Remove all packing tape before plugging in the power cord (see page 7), or damage to the machine may result.

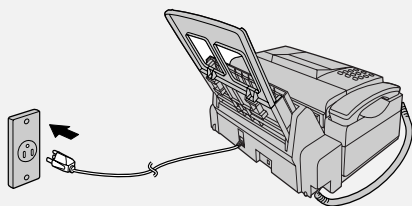

The display will show [**CHECK CARTRIDGE**] until you install the print cartridge.

- ◆ It is recommended that you install surge protectors for the power and telephone lines. Surge protectors can be purchased at most telephone specialty stores.

Installing the Print Cartridge

Print cartridge yield

SHARP UX-C80B replacement cartridge

Ink Save mode OFF:

Approx. 480 letter pages

Ink Save mode ON:

Approx. 800 letter pages

(The initial cartridge has the same yield as the replacement cartridge.)

- ◆ Ink Save mode is initially turned off. To turn on Ink Save mode, see pages 45 and 49.

Caution! Do not open the cover while the machine is printing.

Note: Keep print cartridges sealed in their packages until you are ready to install them. It is recommended that you do not use a cartridge that has been left unused for a long time after opening, as the print quality may be considerably degraded.

- ◆ Make sure the machine's power cord is plugged in and paper is loaded in the paper tray.

- 1 Open the cover (grasp the finger grip).

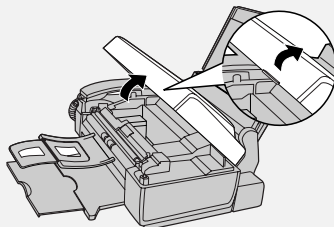

Installing the Print Cartridge

If the display shows [PRINTER ERROR] or [PRINTER ERROR/CHECK PAPER], open the cover and check for jammed paper. Remove any jammed paper (see page 62) and close the cover.

2 Remove only the tape from the new cartridge.

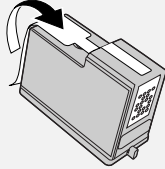

• **Make sure all tape is removed.**

• **CAUTION!**
DO NOT touch the gold contact area on the cartridge.

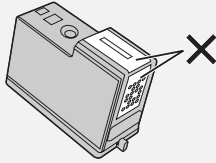

3 Make sure the cartridge holder is in the position shown. Place your fingers on top of the holder and open the holder release.

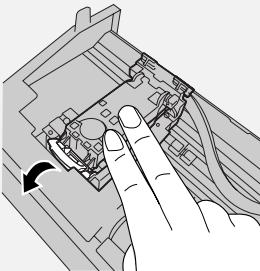

• **CAUTION! DO NOT** touch the gold contact area or pull on the cable.

• If you are replacing the cartridge, remove the old cartridge. If you are going to use the old cartridge again, place it in an air-tight container (containers for this purpose can be purchased at most office supply stores).

4 Insert the new print cartridge (1). Close the holder (2), making sure it clicks into place.

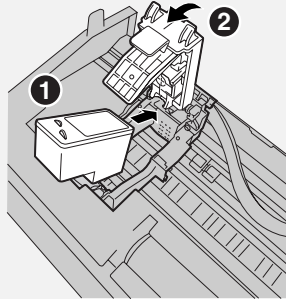

5 Close the cover, pressing firmly on both front corners.

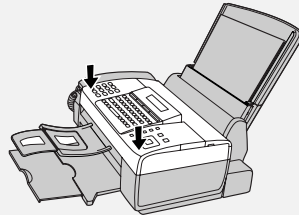

Display: [CHANGE CARTRIDGE]/
[1=NEW, 2=OLD].

6 Press **1** (NEW) if the cartridge you installed is new.

Display: [NEW CARTRIDGE?]/
[OK:PRESS START]

Press **2** (OLD) if the cartridge you installed is old.

7 Press .

If you selected "OLD" in the previous step, this completes the installation procedure. (Note: If you find that print quality is not satisfactory, see p. 53 to align the print cartridge.)

If you selected "NEW", the machine will print an alignment page. Continue with the steps below.

- 8** In the alignment page, locate the line that is closest to a straight line.

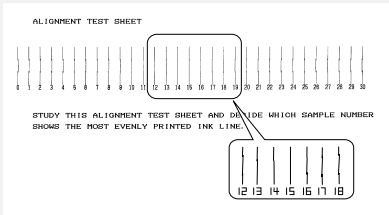

In this example, "15" is closest to a straight line.

- 9** Enter the number of the straightest line with the number keys.

- To clear a mistake, press .

- 10** Press .

The machine is initially set to print high quality images, which require more ink. If you prefer to use less ink and speed up drying time, change the "INK SAVE MODE" setting to "ON" (pp. 45 and 49).

When the resolution is set to HALF TONE, the machine is initially set to print at a slower printing speed to enable higher quality images. When using HALF TONE, if you prefer faster printing at the expense of slightly reduced image quality, change the "QUALITY MODE" setting to "NO" (pp. 45 and 49).

Connecting the Phone Line

TEL. LINE
jack

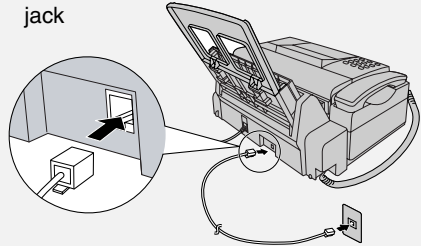

Standard (RJ-11C) wall jack



The machine is initially set for tone dialing. If you are on a pulse dial line, change the "DIAL MODE" setting (pp. 45 and 46).

To change the language used in the display, reports, and lists, change the "LANGUAGE SELECTION" setting as explained on pp. 45 and 48.

Name and Fax Number

Enter your name and fax number.

- Your entered name and fax number will be printed automatically at the top of all fax pages you send. (This is required by FCC regulations.)

- 1** Press , then  until [ENTRY MODE] appears.

- 2** Press .
Display: [OWN NUMBER SET]

- 3** Press . [ENTER FAX #]

Setting the Date and Time

4 Enter your fax number with the number keys (max. 20 digits).

- To insert a space, press **#**.
- To clear a mistake, press **DEL**.

5 Press .

6 Enter your name using the letter keys (max. 24 characters).
Example: SHARP

 **S** **H** **A** **R** **P**

- To clear a mistake, press **DEL**.
- For information on using the text entry keys, see page 6.



7 Press . **[DATE&TIME SET]**

8 Press  to exit.

Setting the Date and Time

Set the date and time.

- ◆ The date and time will be printed automatically at the top of all fax pages you send (this is required by FCC regulations). The date and time also appear in the display.
- ◆ To have the clock automatically move forward and backward at the beginning and end of daylight-saving time, turn on the "DAY LIGHT SAVING" setting (pp. 45 and 47). Do this **before** you set the date and time.

1 Press , then  until **[ENTRY MODE]** appears.

2 Press , then  until **[DATE&TIME SET]** appears.

3 Press .

- The currently set date appears (example): **[DATE 08-15-2006]**

4 Enter a two-digit number for the month ("01" for January, "02" for February, "12" for December, etc.).

Example: January **0** **1**
[DATE 01-15-2006]

- To correct a mistake, press  to move the cursor back to the mistake and enter the correct number.

5 Enter a two-digit number for the day ("01" to "31").

Example: the 5th **0** **5**
[DATE 01-05-2006]

6 Enter the year (4 digits).

Example: **2** **0** **0** **6**

- The currently set time appears (example): **[TIME 12:19 PM]**

7 Enter a two-digit number for the hour ("01" to "12") and a two-digit number for the minute ("00" to "59").

Example 9:25: **0** **9** **2** **5**
[TIME 09:25 PM]

8 Press ***** to select A.M. or **#** to select P.M.

Setting the Reception Mode

9 Press  . **[ANTI JUNK #]**

10 Press  to exit.

Setting the Reception Mode

The machine has three modes for receiving incoming faxes:

AUTO mode:

The machine automatically answers all calls on 4 rings and begins fax reception.

MANUAL mode:

All calls, including faxes, must be answered by picking up the machine's handset or an extension phone connected to the same line.

TEL/FAX mode:

The machine automatically answers all calls on 2 rings. If the machine detects that a call is a voice call (including a manually dialed fax), it makes a special ringing sound to alert you to answer. If the machine detects that the call is an automatically dialed fax, it begins reception automatically.

To set the reception mode, make sure a document **is not loaded in the document feeder**, and then press



 until the desired mode appears in the display.

For more information on receiving faxes, see Chapter 4.

Volume Adjustment



Speaker volume

1 Press  .

2 Press  or  to select **HIGH, MIDDLE, or LOW.**



- Press  again to turn off the speaker.

Handset receiver volume

1 When talking through the handset, press  or  to select **HIGH, MIDDLE, or LOW.**

- **Note:** The volume reverts to **MIDDLE** each time you replace the handset.

Ringer volume

1 Press  or  to select **HIGH, MIDDLE, LOW, or OFF.**

(Make sure  has not been pressed, the handset is not lifted, and a document is not loaded in the feeder.)

- The ringer will ring once at the selected level.
- 2** If you selected “**OFF OK ?**” to turn off the ringer, press  .

2. Fax to E-mail

The Fax to E-mail feature lets you scan a document and directly send the image to an e-mail recipient.

- ◆ This saves you the trouble of scanning the document into a computer and sending the scanned file using an e-mail program.
- ◆ The scanned document is sent as an attachment to an e-mail message. The attached file can be in TIFF or PDF format.

Requirements

To use Fax to E-mail, you must

- ◆ Have a broadband (cable or DSL) Internet connection.
- ◆ Have a broadband router or LAN switch/hub through which you can connect the machine to the Internet (the router is usually connected to a cable modem or DSL modem).

A typical setup is shown below.

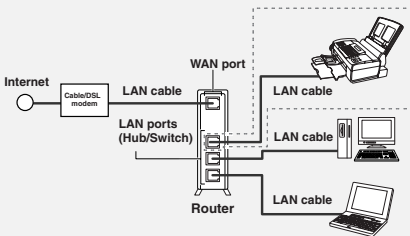

Connecting the Machine

The machine is connected using an Ethernet cable (not included). Please purchase a 10Base-T/100Base-TX straight-through (regular) cable.

Connect one end of the cable to the LAN port on the machine.

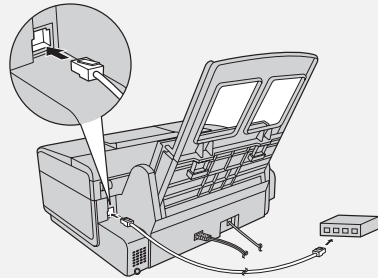

Connect the other end to a LAN port on your router, switch, or hub.

- ◆ If you are uncertain which port to connect the cable to, see the manual for the router, switch or hub.
- ◆ The connections can be made with all devices powered on.
- ◆ For other questions about how the machine should be connected, consult your Internet service provider.

IP address

The machine requires an IP address to communicate on the Internet.





If your network is set up to automatically assign IP addresses, you do not need to do anything; the machine will automatically receive an IP address when it is connected.

Automatic assignment of IP addresses is normally performed by a DHCP server, which may be a computer, router, or other device on the network. (Most routers used on home networks contain a DHCP server.)

If your network requires that a static (permanent) IP address be assigned to the machine, see *Network Settings* on page 23 to enter the IP address and related information.

Checking your IP address and the connection

To check the machine's IP address and verify that the machine is able to communicate on the network, follow these steps.

- 1 Press  , then  until **[NETWORK SETTING]** appears.
- 2 Press  , then  to show **[NETWORK INFORMATION]**

- 3 Press  .

- If the machine has automatically received an IP address and is able to communicate, **[IP ADDRESS/DHCP: ON]** will appear on the top line of the display, followed by the IP address on the bottom line. To show the machine's host name, press



- If a static IP address has been entered in the machine and the machine is able to communicate, **[IP ADDRESS/DHCP: OFF]** will appear on the top line of the display, followed by the IP address on the bottom line. To show the machine's

host name, press .

- If the machine was unable to receive an IP address automatically, or if the router locked up after the machine received an IP address, **[IP ADDRESS/DHCP: FAIL] / [192.168. 1 .201]** will appear. "192.168. 1 .201" is an IP address that is assigned to the machine for diagnostic purposes when connection fails (it cannot be used for regular communication).
- If a cable has not been connected, **[CHECK CABLE]** will appear.
- If **[NOW CONNECTING / CHECK LATER]** appears, press  to exit, wait briefly, and then repeat the procedure again.

Connecting the Machine

If the machine is unable to communicate...

- ◆ Check the Ethernet cable. Are the connections secure? Are you using straight-through (not crossover) cable for 10Base-T/100Base-TX?
- ◆ There may be a problem in the router or other device to which the machine is connected. Try removing and then restoring the power to the router (see the manual for the router).

- ◆ If **[IP ADDRESS/DHCP: FAIL]** appears, remove and then reinsert the Ethernet cable plug, and repeat Steps 1 to 3 above. If the same message appears, check the device that acts as the DHCP server on your network (try removing and restoring the power). If your router is your DHCP server, make sure that DHCP is enabled in the router settings. If your network does not have a DHCP server, set a static IP address as explained on page 23.
- ◆ If a static IP address has been set, make sure that the network settings (page 23) are correct .

E-mail Settings

Before the Fax to E-mail function can be used, you must configure the e-mail settings.

The e-mail settings specify your outgoing mail server, as well as your sender name, sender address, and other items that appear in the e-mail message to which scanned image files are attached.

- ◆ It is easiest to configure the e-mail settings in the machine's Web page. The machine's Web page can be accessed from any computer on the same network as the machine.
- ◆ The e-mail settings can also be configured using the machine's operation panel.

Note: If you need to configure "POP before SMTP" settings, you must use the Web page.

If you do not know your SMTP server name or whether or not you need to configure "POP before SMTP" settings, ask your Internet service provider.

Accessing the machine's Web page

To access the Web page, you will need to know the machine's host name or IP address (usually it is most convenient to use the host name).

To check the machine's host name or IP address, follow the procedure in *Checking your IP address and the connection* (page 15), or print the Network Settings List (page 50).







Type in the host name or IP address of the machine in the Address bar of the Web browser on your computer.

The Web page menu will appear. Select **E-mail Setup** and configure the settings. For explanations of the settings, click **Help** in the Web page menu.

Note: If the Web page is used while the machine is in operation (except for voice calls using the handset), machine operation may become unstable.

Using the machine's operation panel to configure the settings

Follow the steps below to display the e-mail settings, and then configure each setting as explained in the table on the next page.

- 1 Press  , then  until [E-MAIL SETTING] appears.
- 2 Press  , then  repeatedly until the setting that you wish to configure appears.
- 3 Press  . (Note: This step is not necessary for the "FILE FORMAT" setting.)
- 4 Enter the required information for the setting as explained in the table on the next page.
- 5 After configuring the setting, the next e-mail setting will appear in the display. You can configure the next setting, or press  to exit.





E-mail Settings

E-mail settings

Enter the required information for each setting as explained below.

This is done in step 4 of the procedure on the previous page.

- ◆ The sender address and SMTP server settings are required. The other settings are optional.
- ◆ Use the letter keys to enter text. For information on using the letter keys, see page 6.
- ◆ The e-mail subject, e-mail message, and file format that you enter below are default settings. They will be used if you do not specify these items at the time of transmission.

Setting	Description
SENDER NAME	Enter the sender name that will appear in the e-mail message (max. of 50 characters). When finished, press  .
SENDER ADDRESS	Enter your sender e-mail address (max. of 128 characters). When finished, press  . (Note: Be sure to enter your actual e-mail address. Return e-mail and undelivered mail reports will be sent to this address. In addition, some SMTP servers reject outgoing e-mail if a valid sender e-mail address is not entered.)
E-MAIL SUBJECT	Enter a default subject (max. of 128 characters). When finished, press  .
E-MAIL MESSAGE	Enter a default message (max. of 256 characters). When finished, press  .
FILE FORMAT	This sets the default format of the file that is created when you scan a document. Press 1 for TIFF or 2 for PDF. Initial setting: TIFF
SMTP SERVER	Enter the host name or IP address of your outgoing (SMTP) mail server (max. of 60 characters). When finished, press  .

Storing E-mail Addresses

You can store e-mail addresses in the **A**, **B**, and **C** keys, in Rapid Keys, and in Speed Dial numbers.

- ◆ An e-mail address stored in a Rapid Key or the **A**, **B**, or **C** key is selected by simply pressing that key. A total of 36 Rapid Keys are available. (Note: Attach the Rapid Key labels as shown on page 5.)
- ◆ An e-mail address stored in a Speed Dial number is selected by pressing  and entering the 2-digit Speed Dial number. A total of 63 Speed Dial numbers are available.

Note: Rapid Keys and Speed Dial numbers are also used for fax (p. 27).

Storing an e-mail address

Follow the steps below to store an e-mail address using the machine's operation panel.

- ◆ E-mail addresses can also be stored using the machine's Web page. To access the Web page, see page 17.

1 Press , , then .

2 To store an e-mail address in the **A**, **B**, or **C** key, press the desired key and go directly to Step 4.

To store an e-mail address in a Rapid Key, press the desired Rapid Key.

To store an e-mail address in a Speed Dial number, press .

and enter the desired 2-digit number (01 to 63).

- If you prefer to have the machine suggest an available Rapid Key / Speed Dial number at the end of the procedure, press .

3 Press  to select E-MAIL.
Display: **[E-MAIL # MODE]**

4 Enter the e-mail address with the letter and number keys (max. of 128 characters).

- For information on using the letter keys, see page 6.
- To clear a mistake, press .

5 Press .

6 Enter the name of the recipient (max. 20 characters).

7 Press .

- If you selected a Rapid Key or Speed Dial number in Step 2, the display will briefly show **[STORED]**, and then **[NEW NUMBER]**. Go to Step 8.
- If you did not select a Rapid Key or Speed Dial number in Step 2, the display will show the next available Rapid Key or Speed Dial number. If that number is acceptable, press

 and go to Step 8. If not, press the desired Rapid Key, or press the

A, **B**, or **C** key, or press  and

Fax to E-mail Transmission

enter the desired 2-digit Speed Dial number, and go to Step 8.



- 8** Return to Step 2 to store another e-mail address, or press  to exit.

Editing and clearing stored e-mail addresses





To make changes to a previously stored e-mail address, or to clear an address, follow these steps:

- 1** Press , , then .

- 2** Press the key in which the address is stored (Rapid Key or **A**, **B**, or **C** key), or press  and enter the 2-digit Speed Dial number in which the address is stored.

(You can also press  or  until the name or address appears and press .)

Display: [1=EDIT, 2=CLEAR]

- 3** Press  for EDIT or  for CLEAR.
- If you selected CLEAR, go to Step 8.
- 4** If you selected EDIT, make the desired changes to the address.
- Press  or  to move the cursor to the character(s) you wish to change, and then press the appropriate letter or number key. The new character will replace the old character.

- If you do not wish to change the address, go directly to Step 5.

- 5** Press .

- 6** Make the desired changes to the name.

- If you do not wish to change the name, go directly to Step 7.

- 7** Press .

- 8** Return to Step 2 to edit or clear another address, or press  to exit.

Fax to E-mail Transmission

Follow the steps below to send a document to an e-mail recipient.

- ◆ The document will be sent as an attachment to an e-mail message.
- ◆ You can specify the recipient by directly entering an e-mail address, or by selecting an address that has been stored as explained in the previous section.

- 1** Flip up the feeder cover (❶) and adjust the document guides to the width of your document (❷).

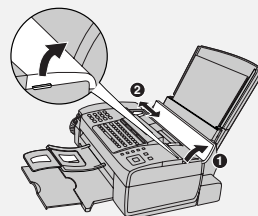



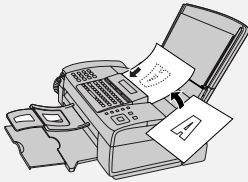



2 Insert the document face down with the top edge going in first.



- Up to 20 letter-size sheets (5 legal-size sheets) can be placed in the feeder at once.
- For more information on loading the document, see page 24.

• If desired, press  to set the resolution and contrast (see p. 25).

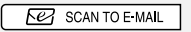
3 Enter the destination e-mail address using one of the following methods:

- Press , press , and enter the address with the letter and number keys (p. 6). When finished, press .
- If the address has been stored in the **A**, **B**, or **C** key, press the key.
- If the address has been stored in a Rapid Key, press the Rapid Key.
- If the address has been stored in a Speed Dial number, press  and enter the Speed Dial number.
- To search for a stored address, press  (this eliminates stored fax numbers from the search), press  or  until the name

or address appears, and press .

Note: If **[CHECK E-MAIL SETTING]** appears, your SMTP server or sender address has not been entered in the e-mail settings (p. 17).



4 If you need to select or change any of the e-mail options, press



 and follow Steps 5 and 6 below. (Note that settings selected here are temporary. To make permanent changes, see p. 17.)

If you do not wish to change the e-mail options, go directly to Step 7.

- To exit the e-mail options, press

 and go to Step 7.

5 Press  or  until the desired option appears, and press

 ( is not necessary for the FILE FORMAT setting). Change the option as explained below (use the letter keys to enter text and



 to delete text; p. 6).

- **E-MAIL SUBJECT:** Enter a subject (max. 128 characters). When

finished, press .

- **E-MAIL MESSAGE:** Enter a message (max. 256 characters).

When finished, press .

- **FILE FORMAT:** Press  for TIFF or  for PDF. (Make sure the recipient has an image viewer that

Fax to E-mail Transmission

can show images in the selected format.)

- **FILE NAME:** Enter a name for the scanned file (max. 40 characters).

When finished, press .

- 6** When you have finished configuring the e-mail options, press

 . (If the display shows [**PRESS START TO SCAN**], it is not necessary to press

 .)

- 7** Press  to begin transmission.

Note: The recipient may have security settings in their e-mail program or virus protection software that prevent the file attachment from being received or opened. In this case, ask the recipient to try changing the settings.

Sending a message only

You can also send a short e-mail message without including a document. Perform Steps 3 through 7 of the above procedure (enter the message in Step 5). After Step 7, [**SEND W/O DOCUMENT?**] / [**1=YES,2=NO,W/T DOC.**]

will appear. Press  to select "YES". The message will be sent.

Error messages

If transmission is not successful because the machine is unable to connect to your mail server, one of the following error messages will appear.

[CONNECTION ERROR]

This appears when communication does not take place correctly on your local network, usually due to a problem with the cable connections. Make sure that the cable ends are securely inserted in the LAN ports. Make sure that the correct cable is being used and that the cable is good. Make sure that your router or hub is powered on.

[SERVER ERROR]

This appears when the machine cannot connect to your mail server or there is no response from the mail server. Make sure the SMTP server setting is correct (p. 18). If you have configured "POP before SMTP" settings in the Web pages, make sure these settings are correct.

[SERVER NOT FOUND] / [SMTP]

This appears when an incorrect host name is entered for your SMTP server. Check the SMTP server setting (p. 18).

[SERVER NOT FOUND] / [DHCP]

This appears when the machine is unable to automatically obtain an IP address. Restart your router or other device that acts as your DHCP server.

[CABLE DISCONNECTED]







This may appear below any of the above messages. Check the same items as in [CONNECTION ERROR] above.

If an undelivered mail report is sent to inform you that your e-mail message was not successfully delivered, the report will be sent to the sender address entered in the e-mail settings (page 17).

Network Settings

If your network requires that you assign a static (permanent) IP address to the machine, follow the steps below to disable DHCP (automatic IP address assignment) and configure the network settings.

- Consult your network administrator for the information that must be entered. After DHCP is disabled, the settings that must be configured appear in the following order (these settings only appear when DHCP is set to NO):
 IP ADDRESS
 SUBNET MASK
 DEFAULT GATEWAY
 DNS (PRIMARY)
 DNS (SECONDARY)

- 1 Press  , then  until [NETWORK SETTING] appears.
- 2 Press  twice. [DHCP] will appear.
- 3 Press  for NO (the machine will not obtain an IP address automatically).
 - [IP ADDRESS] will appear. (If you wish to configure a different setting, press  or .)
- 4 Press  .
- 5 Press the number keys to enter the required number.

- Three digits must be entered in each segment of the number (the segments are separated by periods). If a segment does not have 3 digits, enter zeros as needed. Example: IP address = 192.168.1.2 You must enter: 192.168.001.002

- If you make a mistake, press  to move the cursor to the mistake and enter the correct number.

6 When finished entering the number,

press  .





7 The next setting will appear in the display. Repeat Steps 4 through 6 to configure the next setting, or

press  to exit.

Initializing the network settings

If you need to return the network settings to their initial state, follow the steps below.

- Initializing the settings enables DHCP and clears the IP address and related settings.

- 1 Press  , then  until [NETWORK SETTING] appears.
- 2 Press  twice, then  to show [INITIALIZE SETTINGS].
- 3 Press  twice.

3. Sending Faxes

Transmittable Documents

Minimum document size/weight

Loading up to 20 sheets at once:

5.8" x 5.5" (148 x 140 mm)

14 lbs. (52 g/m²)

Loading 1 sheet at a time:

2.8" x 5.5" (70 x 140 mm)

14 lbs. (52 g/m²)

Maximum document size/weight

Loading up to 20 sheets at once:

Letter (8.5" x 11", 216 x 279 mm)

20 lbs. (75 g/m²)

Loading up to 5 sheets at once:

Legal (8.5" x 14", 216 x 356 mm)

20 lbs. (75 g/m²)

Loading 1 sheet at a time:

Legal (8.5" x 14", 216 x 356 mm)

42 lbs. (157 g/m²)

The maximum scanning width is 8.2" (208 mm), and the top and bottom 0.16" (4 mm) of a document cannot be scanned.

Other restrictions

- ◆ The scanner cannot recognize yellow, greenish yellow, or light blue ink.
- ◆ Remove all clips, staples, and pins before loading documents in the feeder (these will damage the machine).
- ◆ Ink, glue, or correcting fluid on a document must be dry before scanning.

- ◆ Documents which are taped, torn, smaller than the minimum size, carbon backed, easily smudged, or have a slick, coated surface should be photocopied, and the copy loaded in the feeder.
- ◆ Documents that are curled or have a wave-like pattern must be flattened.

Loading the Document

Up to 20 letter-size sheets (5 legal-size sheets) can be placed in the feeder at once. (If the sheets do not feed or double feeds occur, reduce the number of sheets.) The sheets will feed automatically starting from the bottom sheet.

- ◆ To send or copy more than the maximum number of sheets, place the additional sheets gently in the feeder just before the last sheet is scanned. Do not force the sheets in, as this may cause double-feeding or jamming.
- ◆ For large or thick sheets that must be loaded one at a time, insert each sheet into the feeder as the previous sheet is being scanned. Insert gently to avoid double-feeding.

- 1 Flip up the feeder cover (❶) and adjust the document guides to the width of your document (❷).

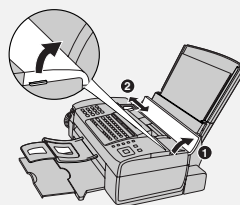

- Place the document face down with the top edge going in first, and insert it all the way into the feeder. Make sure that the roller draws the document in.

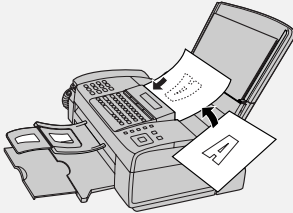

- Display: [READY TO SEND] .

- Adjust the resolution and/or contrast settings (p. 25), and then dial the receiving machine (p. 26).

Removing a document from the feeder

- Open the cover (❶) and remove the document (❷).
- **Caution:** Attempting to remove a document without opening the cover may damage the feeder mechanism.

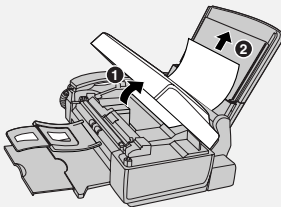

- Close the cover, pressing down firmly on both front corners.

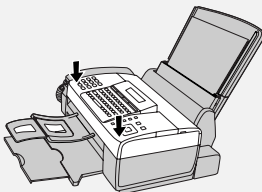

Resolution and Contrast

You can adjust the resolution and contrast before sending a document.

- ◆ The default resolution setting is STANDARD. The default contrast setting is AUTO.
- ◆ Adjust the settings each time you don't want to use the default settings.

Note: The resolution and contrast settings are only effective for sending; not for receiving.

Resolution settings

- STANDARD** Use STANDARD for ordinary documents. This provides the fastest transmission.
- FINE** Use FINE for documents containing small letters or fine drawings.
- SUPER FINE** Use SUPER FINE for documents containing very small letters or very fine drawings.
- HALF TONE** Use HALF TONE for photographs and illustrations. The original will be reproduced in 64 shades of gray.

Contrast settings

- AUTO** Use AUTO for normal documents.
- DARK** Use DARK for faint documents.

Sending a Fax: Normal Dialing

1 Load the document(s).

- The resolution/contrast cannot be adjusted unless the document is loaded.

2 Press one or more times until the desired resolution and contrast settings appear in the display.

- The first time you move through the list of resolution settings, the contrast setting AUTO will appear next to each resolution setting. The second time you move through the list, the contrast setting DARK will appear.

Note: In order to transmit in SUPER FINE resolution, the receiving machine must also have that resolution. If not, your machine will automatically step down to FINE.

If you prefer to use FINE for the default resolution setting, change the "FINE PRIORITY" setting (p. 45).

Sending a Fax: Normal Dialing

With Normal Dialing, you pick up the handset (or press ) and dial by pressing the number keys.

- ◆ If a person answers, you can talk with them through the handset before sending the fax.

- ◆ Normal Dialing allows you to listen to the line and make sure the other fax machine is responding.

1 Load the document(s).

- If desired, press  to set the resolution and/or contrast.

2 Pick up the handset or press . Listen for the dial tone.

3 Dial the fax number of the receiving machine (press the number keys).

4 Wait for the connection. You will either hear a fax tone or the other person will answer.

- If the other person answers, ask them to press their Start key (if you pressed , pick up the handset to speak with them). The receiving machine will issue a fax tone.

5 When you hear the fax tone, press



. Replace the handset.

- If the transmission is completed successfully, the machine will beep once.
- If an error occurs, the machine will beep three times and print a Transaction Report to inform you of the problem (p. 51).

Note: If the transmission is unsuccessful and the display shows [DOCUMENT JAMMED], remove the document as explained on page 62.

Sending a Fax: Auto Dialing

You can store your most frequently dialed fax and phone numbers in Rapid Keys and Speed Dial numbers.

- ◆ A number stored in a Rapid Key is dialed by simply pressing the Rapid Key. A total of 36 Rapid Keys are available. (Note: Attach the Rapid Key labels as shown on page 5.)
- ◆ A number stored in a Speed Dial number is dialed by pressing SPEED DIAL , the 2-digit Speed Dial number, and then START/ MEMORY . A total of 63 Speed Dial numbers are available.

Note: E-mail addresses can also be stored in Rapid Keys and Speed Dial numbers (see page 19).

Storing fax and phone numbers

Follow the steps below to store a fax or phone number using the machine's operation panel.

- ◆ Fax/phone numbers can also be stored using the machine's Web page. To access the Web page, see page 17.

1 Press FUNCTION , then START/ MEMORY .

2 To store a number in a Rapid Key, press the desired Rapid Key. To store a number in a Speed Dial number, press SPEED DIAL and enter the

desired 2-digit number (01 to 63).
Display: **[SELECT DEST. TYPE]**

- If you prefer to have the machine suggest an available Rapid Key / Speed Dial number at the end of the procedure, press START/ MEMORY .

3 Press 1 to select "FAX".
Display: **[FAX # MODE]**

4 Enter the fax or phone number with the number keys (max. of 32 digits). (Note: A space cannot be entered.)

- To clear a mistake, press DEL.
- If a pause is required between any of the digits to access a special service or an outside line, press FUNCTION . The pause appears as a hyphen (two seconds per pause). Several pauses can be entered in a row.

5 Press START/ MEMORY .

6 Enter the name of the destination (max. 20 characters).

- For information on using the letter keys, see page 6.

7 Press START/ MEMORY .

- If you selected a Rapid Key or Speed Dial number in Step 2, the display will briefly show **[STORED]**, and then **[NEW NUMBER]**. Go to Step 8.
- If you did not select a Rapid Key or Speed Dial number in Step 2, the

Sending a Fax: Auto Dialing

display will show the next available Rapid Key or Speed Dial number. If that number is acceptable, press



and go to Step 8. If not, press the desired Rapid Key, or press







and enter the desired 2-digit Speed Dial number, and go to Step 8.

- 8** Return to Step 2 to store another number, or press  to exit.



Editing and clearing auto-dial numbers

To make changes to a previously stored auto-dial number, or clear a number, follow these steps:

- 1** Press , then , then .



- 2** Press the Rapid Key (or press  and enter the 2-digit Speed Dial number) of the number that you want to edit or clear. (You can also press  or  until the number appears and press .)

Display: [1=EDIT, 2=CLEAR]

- 3** Press  for "EDIT" or  for "CLEAR".



- If you selected "CLEAR", go to Step 7.

- 4** If you selected "EDIT", make the desired changes to the number.

- Press  or  to move the cursor to the digit or digits you wish to change, and then enter the new digit. The new digit will replace the old digit.
- If you do not wish to change the number, go directly to Step 5.

- 5** Press .

- 6** Make the desired changes to the name.

- Press  or  to move the cursor to the letter or letters you wish to change, and then press the appropriate letter key. The new letter will replace the old letter.
- If you do not wish to change the name, go directly to Step 7.

- 7** Press .

- 8** Return to Step 2 to edit or clear another number, or press  to exit.

Using an auto-dial number to send a fax

1 Load the document(s).

If desired, press  to set the resolution and/or contrast.

2 Select the fax number using one of the methods below:

- **Rapid Key Dialing:** If the number is stored in a Rapid Key, press the Rapid Key.

- **Speed Dialing:** If the number is stored in a Speed Dial number, press

 and enter the Speed Dial number with the number keys. Make sure the correct destination appears

in the display (if not, press ) , and

then press .

- **Search Dialing:** Press  or

 until the name or number of the other party appears in the

display, and press .

3 Dialing and transmission will take place automatically.

- To cancel transmission, press .



- If the transmission is completed successfully, the machine will beep once.

- If an error occurs, the machine will beep three times and print a Transaction Report to inform you of the problem (p. 51).

Making a voice call with an auto-dial number

Rapid Key Dialing: Lift the handset and press the Rapid Key.

Speed Dialing: Lift the handset, press , and enter the 2-digit Speed Dial number with the number keys.

Search Dialing: Press  or 

until the name or number of the other party appears, and lift the handset. (You can also lift the handset first, search for the number, and then press



Sending a Fax: Auto Dialing

Sending a fax by Direct Keypad Dialing

Use this method to dial a full fax number without using the handset .

1 Load the document(s).

- If desired, press  to set the resolution and/or contrast.

2 Enter the number of the receiving machine with the number keys.

- If a pause is required between any of the digits to access a special service or an outside line, press  . The pause will appear as a hyphen (two seconds per pause). Several pauses can be entered in a row.

3 Check the display. If the number

shown is correct, press  .

- If the number is not correct, press  to clear the incorrect digits, and then re-enter the correct digit(s).

Redial

You can automatically redial the last number dialed on the machine.

1 Load the document(s).

- If desired, press  to set the resolution and/or contrast.

- 2 Press  once. Make sure the display shows the number you wish to dial.

3 If you are sending a fax, press

 . Dialing begins.

If you are making a phone call, lift the handset. Dialing begins.

Note: If the transmission is unsuccessful and **[DOCUMENT JAMMED]** appears in the display, remove the document as explained on page 62.

Automatic redialing

If you use auto dialing (including Direct Keypad Dialing) to send a fax and the line is busy, the machine will automatically make three redial attempts at intervals of five minutes.

During this time, **[RECALLING]** will appear in the display, followed by the attempt number. You will not be able to dial any other locations while the message appears.

- ◆ To clear the message and stop



automatic redialing, press  .

Under certain conditions, automatic redialing may stop before three redialing attempts are made.

Batch Page Numbering

Use this feature to add a slash and the total number of pages to each page number on transmitted fax pages (for example, "P. 1/5", "P.2/5", etc.). This allows the recipient to check for missing pages.



1 Load the document(s).

2 Press , then  to show [PAGE COUNTER].

3 Press .

Display: [ENTER # (01 - 99)]

4 Enter the total number of pages ("01" to "99") with the numeric keys.

Example: 5 pages  .

5 If desired, press  to set the resolution and/or contrast.

6 Dial the receiving machine and send the fax.

- To cancel a batch number entry, remove the document from the

feeder or press .

- If the number of pages actually transmitted is not the same as the batch number entered, an alarm will sound and [PAGE COUNT ERROR] will appear in the display. "PAGE E." will also appear in the **NOTE** column of the Transaction Report if printed.

Sending a Fax From Memory

To increase transmission speed, you can send a fax through the machine's memory. After transmission, the fax is automatically cleared from memory.

Note: If a power failure occurs while sending a fax from memory, you must repeat the operation.



To send a fax through memory, load the document, press , and dial using one of the methods below. (Note that an e-mail destination cannot be selected.)



- ◆ Press a Rapid Key.

- ◆ Press , enter a 2-digit Speed

Dial number, and press .

- ◆ Enter the fax number with the number keys and press .

- ◆ Press  repeatedly to select an auto-dial number and press .

- ◆ Press  once to select the last number dialed and press .

If [MEMORY FULL] appears, see *If the memory becomes full* on page 36.

4. Receiving Faxes

Using AUTO Mode

To select AUTO mode, press

 (with no document in the feeder) until **[AUTO]** appears in the display.

In AUTO mode, the machine automatically answers all calls on 4 rings and receives incoming faxes.

- ◆ If you pick up the handset before the machine answers, you can talk to the other party and receive a fax as explained in *Using MANUAL Mode* below.

To change the number of rings on which the machine answers calls, change the “NUMBER OF RINGS” setting (p. 45).

The machine automatically reduces received faxes as needed to fit the paper. If you prefer to have all faxes printed at full size, change the “RECEIVE RATIO” setting (pp. 45 and 48).

Using MANUAL Mode



To select MANUAL mode, press

 (with no document in the feeder) until **[MANUAL]** appears in the display.

In MANUAL mode, you must answer all calls (even faxes) by picking up the machine's handset or an extension phone connected to the same line.

Answering with the machine's handset

Important: If a document is loaded in the machine's feeder, remove it before performing the steps below.

- 1** When the machine rings, pick up the handset.
- 2** If you hear a fax tone, wait until the display shows **[RECEIVING]** and then replace the handset.
 - If **[RECEIVING]** does not appear (or if you have set the Fax Signal Receive setting to NO (pp. 45, 47)), press  to begin reception.
- 3** If the other party first speaks with you and then wants to send a fax, press  after speaking. (Press before the sender presses their Start key.)
 - When **[RECEIVING]** appears in the display, hang up.

Answering a call on an extension phone connected to the same line

- 1** Answer the extension phone when it rings.
- 2** If you hear a soft fax tone, wait until you hear pronounced, high-pitched fax tones, then hang up.
- 3** If the machine doesn't respond, or if the other party first talks to you and then wants to send a fax, set the phone down (do not hang up), walk over to the machine, lift the

machine's handset, and press



- The above step is necessary if you have set the "FAX SIGNAL RX" setting to NO (pp. 45 and 47).

Putting a call on hold

To put the other party on hold during a phone call, press . When this is done, they cannot hear you. You can put the handset back in the cradle without breaking the connection. When you are ready to speak with the other party again, pick up the handset. If you did not put the handset back in the

cradle, press again to resume conversation.

TEL/FAX Mode

To select TEL/FAX mode, press



(with no document in the feeder) until **[TEL/FAX]** appears in the display.

When the reception mode is set to TEL/FAX, the machine automatically answers all calls on 2 rings. After answering, the machine monitors the line for about five seconds to see if a fax tone is being sent.

- ◆ If the machine detects a fax tone (this means that the call is an automatically dialed fax), it will automatically receive the fax.

- ◆ If your machine doesn't detect a fax tone (this means that the call is a voice call or manually dialed fax), it will make a special ringing sound for 15 seconds to alert you to pick up the machine's handset (to change the number of seconds, see p. 45 and "PSEUDO RING DURATION" on p. 46). If you don't answer within this time, the machine will send a fax tone to the other machine to allow the calling party to send a fax manually.

Note: Only the machine will make the special ringing sound. An extension phone will not ring after the machine initially answers the call.

Reception to Memory

Incoming faxes will be received to memory when printing is not possible, such as when the machine runs out of paper, the print cartridge needs replacement, or the paper jams.

When you have received a fax in memory, **[FAX RX IN MEMORY]** will appear in the display, alternating with a message that indicates the problem.

When you resolve the problem, the stored faxes will automatically print out.

- ◆ If you received faxes to memory because the machine ran out of paper, be sure to add paper that is the same size as the paper previously used, or the fax print-out size will not match the size of the printing paper.

5. Making Copies

The machine can be used as a convenience copier. Follow the steps below to make copies.

Sorting copies

The machine is initially set to not sort copies. If you wish to have copies sorted as shown below, change the "SORT COPY" setting to YES (pp. 45 and 49).

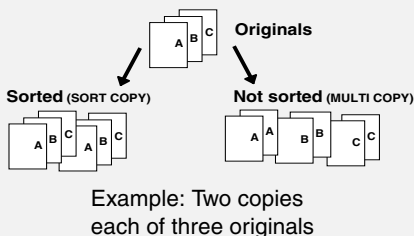

1 Load the document(s). (Maximum of 20 letter sheets or 5 legal sheets.)

- If desired, press  to set the resolution and/or contrast.

2 Select the following copy settings as needed:

- **Enlarge/reduce:** Press  or



to select 100%, 125%, 135%, 200%, 70%, 88% or 94%.
Default setting: 100%.

- **Number of copies per original:**

Enter a number from 1 to 99.
Default setting: 1

Example: Press  for two copies

3 When you are ready to begin

copying, press  .

If [MEMORY FULL] appears...

If you place many originals in the feeder, the memory may become full before all pages can be scanned (the display will show [MEMORY FULL]). If this happens, only the pages that were scanned will be copied and the remaining pages will automatically feed out. Repeat the copy procedure for the remaining pages, including the page that was being scanned when the memory became full.

Note: It may not be possible to make a copy of an original if a high resolution setting is used and/or the original contains so much detailed content that the memory becomes full before scanning finishes.

6. Special Functions

Broadcasting

You can send the same document to as many as 20 fax or e-mail destinations in just one operation.

- ◆ The destinations must be all fax or all e-mail. It is not possible to mix fax and e-mail destinations.
- ◆ Only destinations stored in Rapid Keys and Speed Dial numbers can be selected. (It is not possible to enter a full fax number or e-mail address.)







1 Load the document(s).

- If desired, press  to set the resolution and/or contrast.

2 Press .

3 Press to broadcast to FAX destinations, or to broadcast to E-MAIL destinations.

4 Select a destination using one of the following methods:



- Press a Rapid Key.
- Press  and enter a 2-digit Speed Dial number.
- Press  or  until the desired destination appears in the display.
- Press , , or  (only for an e-mail destination).

5 Press to enter the destination.

6 Repeat Steps 4 and 5 for each of the other desired destinations (maximum of 20).

- You can press  to scroll through and check your entered destinations. To delete a destination, press  when it appears.

7 When you have finished selecting destinations, press .

- If you are broadcasting to fax destinations, transmission will begin.
- If you are broadcasting to e-mail destinations, you can press  to select e-mail options (see Steps 4 to 6 on page 21). When you are ready to begin transmission, press .
- For fax, a Transaction Report is automatically printed out after Broadcasting is completed. If any destinations in the "Note" column of the report are marked "Busy" or have a communication error code, you will need to send the document to those destinations again.

Broadcasting

If the memory becomes full...

If the memory becomes full during scanning, [MEMORY FULL] will appear in the display.

- ◆ Press  to send the pages which have been stored up to that point in memory (the remaining pages will automatically feed out). After transmission, the memory will be cleared and you can send the remaining pages. You will also need to send the page which was being scanned when the memory filled up.

- ◆ To cancel the entire transmission,

press .



Broadcasting using a Group Key

If the destinations to which you want to broadcast have all been stored in one Group Key (see *Storing numbers in Group Keys* which follows), you can perform the broadcast operation using the following simplified procedure:



- 1 Load the document(s).

- If desired, press  to set the resolution and/or contrast.

- 2 Press the appropriate Group Key

( or .

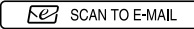

- If the group is a fax group, transmission will begin.

- If the group is an e-mail group, you can press  to select e-mail options (see Steps 4 to 6 on page 21). When you are ready to begin transmission, press .



Storing destinations in Group Keys

Follow the steps below to store a group of destinations in a Group Key.

- ◆ Rapid Keys 33/G1 and 34/G2 can be used as Group Keys. A key cannot be simultaneously programmed as both a Group Key and a Rapid Key.
- ◆ Up to 20 fax or e-mail destinations can be stored in one Group Key.
- ◆ The destinations must be all fax or all e-mail. It is not possible to mix fax and e-mail destinations.
- ◆ Only Rapid Key and Speed Dial numbers can be stored in a Group Key. Full numbers cannot be stored.

1 Press , then  until [ENTRY MODE] appears.

2 Press , then  until [GROUP ENTRY] appears.



3 Press  (SET) to store a group. (Press  (CLEAR) to clear a group.)

- If [GROUP SPACE FULL] appears, both keys have already been

Caller ID (Requires Service)



programmed. Clear one of the keys and then store a group.

4 Press the Group Key that you want

to use ( or ). (If you are clearing a Group Key, press the Group key that you want to clear and go to Step 8.)



- If [ALREADY STORED] or [RAPID # STORED] appears, the key has already been programmed. Clear the key or try the other Group Key.

5 Select a destination using one of the following methods:

- Press a Rapid Key.
- Press  and enter a 2-digit Speed Dial number.
- Press  or  until the desired destination appears in the display.
- Press , , or (only for an e-mail destination).

6 Press to enter the destination.

7 Repeat Steps 5 and 6 for each of the other desired destinations (maximum of 20).

- You can press  to scroll through and check your entered destinations. To delete a destination, press  when it appears.

8 When you have finished entering

the destinations, press .

9 Press to exit.

Caller ID (Requires Service)

Important: To use this function, you must subscribe to a Caller ID service from your phone company. The machine may not be compatible with some Caller ID services.

If you subscribe to a Caller ID service, you can have the machine show the name and number of the caller when you receive a call.

1 Press , then until [OPTION SETTING] appears.

2 Press , then until [CALLER-ID] appears.

3 Press (YES) to turn on Caller ID. (To turn off Caller ID, press and go to Step 7.)

4 If the area code **must not** be included when you dial a local phone number (within your area code), press to select SET and enter your area code in Step 5. (This will remove the area code from local numbers stored in the Caller ID list, allowing you to automatically dial those numbers from the list (see

Caller ID (Requires Service)

(Caller ID list on this page).)

If you do not need to have the area code removed from local numbers

in the Caller ID list, press **2** and go to Step 7.

5 Enter the 3 digits of your area code.

6 Press .

7 Press  to exit.

Note: Some caller ID services may not provide the name of the caller. In this case, only the phone number will appear when you receive a call.

Display messages

One of the following messages will appear while the machine rings if caller information is not available.



NO SERVICE	No caller information was received. Make sure that your service has been activated.
CALLER-ID ERROR	Noise on the telephone line prevented reception of caller information.
OUT OF AREA	The call was made from an area which does not have Caller ID service, or the service is not compatible with your service.
PRIVATE CALL	Caller information was not provided at the caller's request.

Caller ID list

The machine keeps a log of the most recent 30 calls and faxes you have received (the Caller ID list). You can view the list and automatically dial a number from the list.

- ◆ The list is only available if you have Caller ID service and have turned on the Caller ID function.
- ◆ After you have received 30 calls, each new call will delete the oldest call.
- ◆ The Caller ID list can also be printed. See page 50.

1 Press  until [**REVIEW CALLS>**] appears.

2 Press  or  to scroll through the list.

- To exit the list, press .

3 To dial a number, display the number and:

- **Fax:** Load the document and press . Transmission will begin.
- **Voice call:** Pick up the handset. Dialing will begin automatically.

Deleting calls from the list

To delete a single call from the list, display the call and press .

Distinctive Ring (Requires Service)

To delete all calls from the list, hold

 down for 3 seconds while viewing any number in the list.

Blocking voice calls

If you have turned on Caller ID, the Anti Junk Fax function will block voice calls as well as faxes from your specified Anti Junk Number (see p. 40).



Note: This function cannot be used if you are using Distinctive Ring.

Distinctive Ring (Requires Service)

Important: To use this function, you must subscribe to a Distinctive Ring service from your telephone company. The machine may not be compatible with some Distinctive Ring services.

Distinctive Ring is a service offered by some local telephone companies whereby they assign an additional second number to your regular single line. The second number rings differently from your normal number.

If you subscribe to a Distinctive Ring service, you can set the machine to automatically answer when your second number is called. This allows you to use the second number as an exclusive fax number.

1 Press  , then  until [OPTION SETTING] appears.

2 Press  , then  until [DISTINCTIVE RING] appears.

3 Select the ring pattern below that matches the ring pattern of your second number. (To use your first number as a fax number, select STANDARD RING.)

- 1** RING PATTERN 1
Two short rings
- 2** RING PATTERN 2
One short, one long, and one short ring
- 3** RING PATTERN 3
Two short rings and one long ring
- 4** RING PATTERN 4
Three very short rings
(Canada only)
- 5** RING PATTERN 5
Two very short rings
(Canada only)
- 6** STANDARD RING
Your standard (normal) ring pattern
- 7** OFF SETTING
Turn distinctive ring off

4 Press  to exit.

5 Press  to set the reception mode to AUTO.







◆ To use Distinctive Ring, the reception mode must be set to AUTO. When your designated fax number is dialed, the machine will automatically answer and begin reception after two rings. If one of your other numbers is dialed, the machine will ring; however, it will not answer.

Blocking Unwanted Faxes

Blocking Unwanted Faxes

The Anti Junk Fax function blocks reception of faxes from a fax number that you specify.

To use this function, enter the fax number that you want to block. Only one number can be entered.

- 1 Press , then  until [ENTRY MODE] appears.
- 2 Press , then  until [ANTI JUNK #] appears.
- 3 Press  (SET) to store an Anti Junk number.
(To clear a previously stored number, press  (CLEAR) and go to Step 5.)
- 4 Enter the number with the number keys (max. 20 digits).

5 Press .

6 Press  to exit.

- ◆ When a fax is blocked (or when a voice call is blocked if you are using the Caller ID function), a transaction report (page 51) will print to inform you (unless "TRANSACTION LIST" on page 46 is set to "NEVER PRINT").

Duplex Scanning

Duplex Scanning is convenient for transmitting or copying two-sided documents. When this function is selected, you simply feed all pages of the document through the machine once, turn the stack of pages over, and feed the stack through again. The machine will automatically sort the pages into the correct order (front of 1st page, back of 1st page, front of 2nd page, back of 2nd page, etc.).

- ◆ Note that any blank sides must be included when scanning the pages (if the number of pages is not equal each time the machine scans the stack, an error will result).

1 Load the documents. Make sure the pages are placed front-side down, with the first page on the bottom.

- If desired, press  to set the resolution and/or contrast.

2 Press  and then .

3 Perform all steps of the desired copy or transmission operation.

4 When all pages of the document have been scanned, turn the stack over (do not change the page order) and load the stack again.

5 Press .

Receiving Faxes to E-mail









You can have incoming faxes from specified fax numbers (or all fax numbers) automatically converted to e-mail and forwarded to designated e-mail recipients.

- ◆ This provides a convenient means of forwarding received faxes to someone who is out of the office.
- ◆ This function can also be used to send copies of all received faxes to an administrator for centralized document storage.

Storing (or clearing) groups of originating fax numbers and forwarding e-mail addresses

To use the Receive Fax to E-mail function, you must first store one or more groups of originating fax numbers and forwarding e-mail addresses.



- ◆ One originating fax number and one forwarding e-mail address can be stored in each group. When a fax is received, the machine will check each stored group, and if the originating number of the received fax matches a fax number in one of the groups, the machine will forward the fax to the e-mail address in that group.
- ◆ You can also omit entry of an originating fax number in a group and have faxes from all originating fax numbers forwarded to the e-mail address.
- ◆ Up to 10 groups can be stored.

- 1 Press  , then  until [RCV FAX TO E-MAIL] appears.
- 2 Press  , then  to show [FORWARDING ADDRESS] / [1=SET, 2=CLEAR]
- 3 Press  to select "SET".
 - To clear a previously stored group, press .
- 4 Enter a 2-digit number from "01" to "10" (this number is used to identify the group you will store).
 - If you are clearing a group, enter the 2-digit number of the group you wish to clear and go to Step 8.
- 5 Enter the originating fax number.
 - If you wish to have faxes from all originating fax numbers forwarded, go directly to Step 6 without entering a fax number.
- 6 Press .
- 7 Enter the e-mail address to which you wish to have the faxes forwarded.
 - For information on using the letter keys, see page 6.
- 8 Press .
- 9 Return to Step 4 to store (or clear) another group, or press  to exit.

Receiving Faxes to E-mail

Activating (and deactivating) Receive Fax to E-mail

After you have stored one or more Receive Fax to E-mail groups, follow the steps below to activate the Receive Fax to E-mail function.

1 Press  , then  until [RCV FAX TO E-MAIL] appears.

2 Press .



3 Press  to select "ON".



- To turn off Receive Fax to E-mail, press .



4 Press  to exit.

Printing forwarded faxes

The machine is initially set to not print received faxes that are forwarded. If you want the machine to print forwarded faxes, follow the steps below.

1 Press  , then  until [RCV FAX TO E-MAIL] appears.



2 Press  , then  until [PRINT RECEIVED FAX] appears.

3 Press  to select YES (print forwarded faxes) or  to select NO.



4 Press  to exit.

Printing a report

The machine is initially set to print a fax forwarding report only when a forwarding error occurs. If you would like the machine to print a report each time it forwards a received fax, follow the steps below.

1 Press  , then  until [RCV FAX TO E-MAIL] appears.

2 Press  , then  until [REPORT SETTING] appears.

3 Press  (PRINT ERROR ONLY) to print a report only when an error occurs, or  (ALWAYS PRINT) to print each time a fax is forwarded.

4 Press  to exit.



Secure Receive

To prevent others from viewing or taking your received faxes, use the Secure Receive function. When this function is activated, received faxes are held in memory without being printed. To print the faxes, a 4-digit "secure code" must be entered.

Setting a secure code

The secure code is used to print received faxes. Follow the steps below to set a secure code.

- The secure code can be any 4-digit number.

1 Press , then  until [SECURE # SET] appears.

2 Press .

3 Enter a 4-digit secure code.

4 Press .

- The machine will print the secure code for your records.
- Take care not lose the print-out or forget the code. In the event that you forget the code and have kept no record, contact Sharp's Customer Assistance Center at 1-877-794-8675.

Activating Secure Receive

Follow the steps below to activate Secure Receive.

- Secure Receive cannot be activated unless a secure code has been set.

1 Press , then  until [ACTIVATE SECURE RCV.] appears.

2 Press .

3 Press  to select "YES".

4 Press  to exit.

Printing received faxes

When the memory is holding one or more received faxes, [RECEIVED SECURE FAX] will appear in the display. Follow the steps below to print the faxes.

1 Press  to until [SECURE DATA PRINT] appears.

2 Press .

3 Enter the 4-digit secure code.

4 Press .

- Printing will begin.
- If the wrong code is entered, [WRONG SECURE #] will appear. Go back to Step 3.

Secure Receive

Deactivating Secure Receive

If you need to deactivate Secure Receive (faxes will be automatically printed when received), follow the steps below.

1 Press , then  until [ACTIVATE SECURE RCV.] appears.

2 Press .

3 Press  to select "NO".

4 Enter the 4-digit secure code.



5 Press .

- The display will briefly show [NO SELECTED] and then the date and time.
- If the wrong code is entered, [WRONG SECURE #] will appear. Go back to Step 4.

Clearing the secure code

To clear the secure code, follow the steps below.

- Secure Receive must be deactivated before you can clear the secure code.

1 Press , then  until [SECURE # CLEAR] appears.

2 Press .

3 Enter the 4-digit secure code.

4 Press .



- The display will briefly show [CLEARED] and then the date and time.
- If the wrong code is entered, [WRONG SECURE #] will appear. Go back to Step 3.



7. Option Settings and Print Settings

The option settings and print settings allow you to customize the operation of the machine to better suit your needs.

The option settings are related to general operation. The print settings are related to printing.

The option settings and print settings have been initially configured at the factory. To change a setting, follow the steps below to display the desired setting, and then change the setting as explained in the tables that follow.

1 Press  , then  until [OPTION SETTING] or [PRINT SET-UP] appears.

2 Press  , then  repeatedly until the desired setting appears.

- The option settings and print settings are described in the tables below and on the following pages.



3 Enter a selection for the setting by pressing the number keys as explained in the table.

4 After entering a selection, the subsequent option/print setting will appear in the display. To exit the

settings, press  .

Option Settings

Make a selection for the displayed setting as explained below. This is done in step 3 of the above procedure.

Setting	Description
FINE PRIORITY	This is used to change the default resolution for faxing from STANDARD to FINE. Press  (YES) to select FINE, or  (NO) to select STANDARD. Initial setting: NO (STANDARD)
NUMBER OF RINGS	This is used to set the number of rings on which the machine answers calls when the reception mode is set to AUTO. Enter any number from 2 to 5 . Initial setting: 4 rings. Note: If you have turned on Distinctive Ring (page 39), the machine will answer after 2 rings regardless of this setting.

Option Settings

TRANSACTION LIST	<p>This sets the condition for printing transaction reports (see page 51). Press a number key as follows:</p> <ul style="list-style-type: none">1 (ALWAYS PRINT): Print after every fax transmission, reception and error.2 (ERROR/MEMORY): Print only after an error or memory operation.3 (SEND ONLY): Print after every fax transmission.4 (ERROR ONLY): Print only when an error occurs.5 (NEVER PRINT): Never print. <p>Initial setting: ERROR ONLY</p>
DIAL MODE	<p>This sets the dial mode. Press 1 (TONE) if you are on a tone dial line, or 2 (PULSE) if you are on a pulse dial line.</p> <p>Initial setting: TONE</p>
PSEUDO RING DURATION	<p>This sets the duration of the special ringing sound that alerts you to voice calls and manually dialed faxes in TEL/FAX reception mode. Press a number key as follows:</p> <ul style="list-style-type: none">1 15 seconds2 30 seconds3 60 seconds4 120 seconds <p>Initial setting: 15 seconds</p>
DISTINCTIVE RING	<p>If you subscribe to a distinctive ring service from your phone company, use this setting to select the ring pattern of the phone number that you will use as a fax number. For more information, see page 39.</p> <p>Initial setting: OFF SETTING</p>

FAX SIGNAL RX	<p>The machine will automatically begin reception if you hear a soft fax tone after answering a call on the machine's handset or an extension phone. If you use a computer fax modem to send documents on the same line, you must turn this function off in order to prevent the machine from mistakenly attempting to receive documents from the computer fax modem. Press 1 (YES) to turn on the the automatic reception function, or 2 (NO) to turn off the function. If you select NO, you must start reception manually by pressing  on the machine each time you hear a soft fax tone after answering a call. Initial setting: YES</p>
CALLER-ID	<p>If you subscribe to a Caller ID service from your phone company, use this setting to have the ID of the caller appear in the display each time you receive a call. For more information, see page 37. Initial setting: NO</p>
AUTO PRINT OUT	<p>Press 1 (YES) to have the machine automatically print an Activity Report once every 30 send/receive operations. (The report can still be printed manually at any time.) Press 2 (NO) to turn off Auto Print Out. Initial setting: NO</p>
ECM MODE	<p>Press 1 (YES) to have any distortions in a transmission due to noise on the telephone line automatically corrected before print-out at the receiving end. This is only effective when the other machine has ECM as well. Press 2 (NO) to turn off ECM mode. (When there is considerable noise on the line, you may find that ECM slows transmission. Turning off ECM mode may increase transmission speed.) Initial setting: YES</p>
DAY LIGHT SAVING	<p>To have the machine's clock automatically move forward and backward at the beginning and end of daylight saving time, press 1 (YES). To turn off this feature, press 2 (NO). Initial setting: NO</p>

Print Settings

LANGUAGE SELECTION	This sets the language that appears in the display, reports, and lists. Press 1 for English or 2 for Spanish. A beep will sound and the display will change to the selected language. Initial setting: ENGLISH
DIAL TONE DETECTION	Press 1 (YES) to have the machine verify the presence of a dial tone on the line before automatic dialing. Press 2 (NO) to turn this function off. Note: If you select YES and find that the machine is unable to dial, change the setting to NO. Initial setting: NO
KEY TONE	Press 1 (ON) to have the machine sound a beep each time a key is pressed on the operation panel (this confirms that the key has been correctly pressed). Press 2 (OFF) to turn off the beep sound. Initial setting: ON

Print Settings



Make a selection for the displayed setting as explained below.
This is done in step 3 of the procedure on page 45.

Setting	Description
RECEIVE RATIO	Press 1 (AUTO) to have the machine automatically reduce the size of received faxes to fit the size of the printing paper. This ensures that the edges of a fax are not cut off. (Note: AUTO may not operate if the received fax is too long, contains many fine graphics or images, or is sent at high resolution. In this case, the remainder of the fax will be printed on a second page.) Press 2 (100%) to have all faxes printed at full size (if a fax is too long to fit on the paper, the remainder will be printed on a second sheet; note that the cut-off point may occur in the middle of a line). Initial setting: AUTO



PAPER SIZE	<p>This sets the size to which the machine scales received faxes. Press 1 (LETTER) if you loaded letter size paper, or 2 (LEGAL) if you loaded legal size paper. Initial setting: LETTER</p>
SORT COPY	<p>This setting determines whether or not copies are collated (sorted into sets) when multiple copies of each original page are made. Press 1 (YES) to have copies automatically sorted, or 2 (NO) to have copies grouped by page. Initial setting: NO</p>
INK SAVE MODE	<p>To use less ink and speed up ink drying time when printing faxes and copies, press 1 (ON) to turn on Ink Save Mode. If you prefer a higher quality image, press 2 (OFF) to turn off Ink Save Mode. Initial setting: OFF</p>
QUALITY MODE	<p>To have the machine print higher quality images by printing slowly when the resolution is set to HALF TONE, press 1 (YES) to turn on Quality Mode. If you prefer faster printing at the expense of slightly reduced image quality when using HALF TONE, press 2 (NO) to turn off Quality Mode. (Note: This setting does not affect the amount of ink used.) Initial setting: YES</p>
ALIGN CARTRIDGE	<p>This is used to align the print cartridge to improve print quality. See page 53.</p>
CLEAN NOZZLES	<p>This is used to clean the print cartridge nozzles if print quality is not satisfactory after aligning the print cartridge. See page 53.</p>

8. Printing Lists

You can print lists showing settings and information entered in the machine.

1 Press  , then  until [LISTING MODE] appears.

2 Press .

3 Press  or  until the desired list (see below) appears.

- **ACTIVITY LIST:** This report shows information on your most recent transmissions and receptions (combined maximum of 30). The headings are the same as in the Transaction Report (see the next section). The logged transactions are erased after the report is printed. To have the report print automatically whenever the number of logged transactions reaches 30, see page 45 and “AUTO PRINT OUT” on page 47.
- **DESTINATION LIST:** This shows the fax and e-mail destinations that have been stored in Rapid Key and Speed Dial numbers (pp. 19 and 27).

- **GROUP LIST:** This shows the destinations that are stored in the Group Keys (p. 36).
- **SETUP LIST:** This shows your currently entered sender's name, sender's number, and anti-junk fax number, your current selections for the option settings, print setup, and receive faxes to e-mail, and a sample of the header printed at the top of every fax page you transmit (**HEADER PRINT**).
- **CALLER-ID LIST:** This shows information on your 30 most recently received calls and faxes (p. 38). (This list is only available if you are using the Caller ID function.)
- **RECEIVE FAX TO E-MAIL LIST:** This shows the Receive Fax to E-mail settings that have been stored (page 41).
- **NETWORK SETTING LIST:** This shows the machine's current IP address and other network/Internet settings (page 23).

4 Press  to print the list.

Transaction Report

This report is printed out automatically after a fax is sent or received to allow you to check the result. The machine is initially set to print out the report only when an error occurs.

- ◆ The Transaction Report cannot be printed manually. To change the condition for automatically printing out Transaction Reports, see page 45 and "TRANSACTION LIST" on page 46.

Headings in the Transaction Report

SENDER/RECEIVER	The name or fax number of the other machine.
START	Starting time.
TX/RX TIME	Total time taken for transmission/reception.
PAGES	Number of pages.

NOTE

One of the following notes will appear under **NOTE** to indicate whether the fax was successful, and if not, why it failed.

OK - Transmission/reception was successful.

P.FAIL - A power failure prevented the transaction.

JAM - The printing paper or document jammed.

BUSY - The fax was not sent because the line was busy.

COM.E-X - (Where "X" is a number.) A communication error occurred. See page 56.

CANCEL - The fax was canceled because the **STOP** key was pressed, no document was in the feeder, or the other machine requested a function that your machine does not have.

9. Maintenance

Cleaning the Machine

Cleaning the scanning glass and rollers

Any dirt on the scanning glass and rollers will degrade the quality of transmitted documents and copies. Clean these frequently as explained below.

- ◆ If the document does not feed or double-feeds occur, use a cloth moistened with water to wipe the rollers.

- 1 Open the cover.

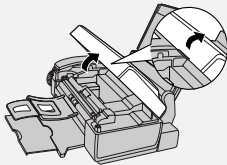

- 2 Rotate the lever so that it points straight up (1) and pull it up (2).

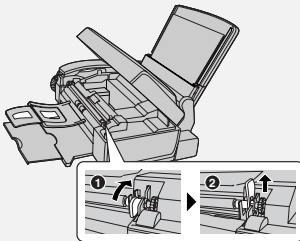

- 3 Pull the white roller out to the right. Wipe the scanning glass, rollers, and rubber sheet with a clean cloth or swab.

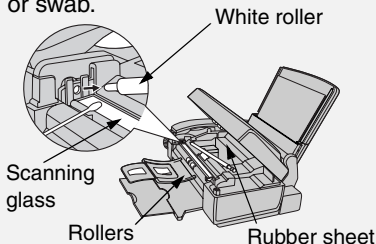

- Do not wipe off the grease on the ends of the white roller.
 - Make sure that all dirt and stains (such as correcting fluid) are removed. Dirt and stains will cause vertical lines on transmitted images and copies.
 - If the scanning glass is difficult to clean, try moistening the cloth with isopropyl alcohol or denatured alcohol. Take care that no alcohol gets on the rollers.
 - Do not press down on the two front rollers.
 - Use a cloth moistened with alcohol to wipe off any splattered ink on the inside of the compartment or the underside of the cover. (Do not wipe the rollers or rubber sheet with the alcohol-moistened cloth.)
- 4 Replace the white roller, inserting the left end first. Push the lever down and rotate it back down.

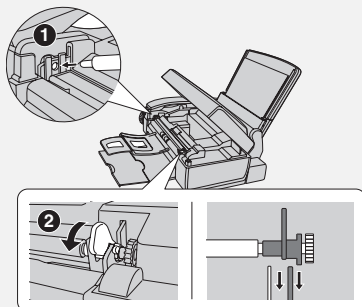

- 5** Close the cover, pressing down firmly to make sure it clicks into place.

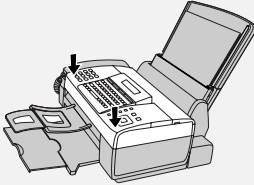

Cleaning the housing

Wipe the external parts and surface of the machine with a dry cloth.







Caution: Do not use benzene or thinner. These solvents may damage or discolor the machine.

Improving Print Quality

Aligning the print cartridge

If print quality is not satisfactory, first try aligning the print cartridge.

Note: Make sure that paper is loaded before beginning this procedure.

- 1** Press , then  until [PRINT SET-UP] appears.
- 2** Press , then  until [ALIGN CARTRIDGE] appears.
- 3** Press  to print an alignment page. (To enter an alignment value without printing a page, press .)

- 4** In the page that the machine prints, locate the line that is closest to a completely straight line.

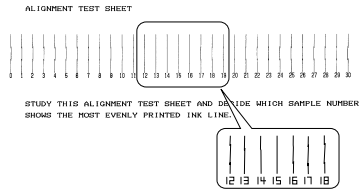

In this example, "15" is closest to a straight line.

- 5** Enter the number of the straightest line with the number keys.





- To clear a mistake, press .

- 6** Press . [CLEAN NOZZLES]

- 7** Press  to exit.

Cleaning the print cartridge nozzles

If print quality is still not satisfactory after aligning the print cartridge, clean the print cartridge nozzles.

- 1** Press , then  until [PRINT SET-UP] appears.
- 2** Press , then  until [CLEAN NOZZLES] appears.
- 3** Press .

Improving Print Quality

- The machine prints a test pattern similar to the one shown in the following step.

4 Compare the diagonal lines above the printed bars to the diagonal lines below the printed bars.

- Look for breaks in the diagonal lines above the bars. Breaks indicate clogged nozzles.

Breaks in the diagonal lines at the top of the page indicate clogged nozzles.

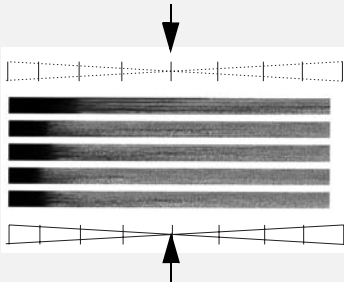

Unbroken lines at the bottom of the page indicate the nozzles were cleaned.

- 5** If the bottom diagonal lines still have breaks, repeat Steps 1 through 4 to clean the nozzles again. Repeat several more times if necessary.
- If the print quality is still not satisfactory after cleaning the nozzles several times, continue with Step 6.
- 6** Open the cover and remove and then reinstall the print cartridge (see the procedure beginning on page 9).
- 7** Repeat the nozzle cleaning procedure. If the lines are still broken, wipe the nozzles as explained in the following section.

Wiping the print nozzles and contacts

If you have cleaned the print nozzles as explained in the previous section at least three times and print quality is still not satisfactory, try wiping the print nozzles and contacts.

1 Open the cover and remove the print cartridge (see the procedure beginning on page 9).

- **CAUTION! DO NOT** touch the gold contact area of the cartridge or the contact area of the cartridge holder with your fingers.

2 Place two or three sheets of paper on a table or other flat surface. Moisten a clean, lint-free cloth with warm water and place the cloth on the paper.

3 Gently press the nozzles against the cloth for about three seconds, and then move the cartridge slowly in the direction shown to wipe the nozzles.

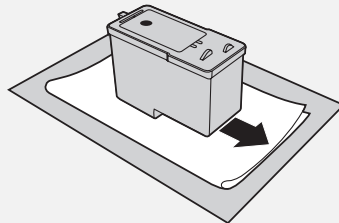

4 Using another clean section of the cloth, repeat the above step.

- 5** Moisten another clean cloth with warm water. Gently hold the cloth against the contacts for about 3 seconds, and then wipe in the direction shown.

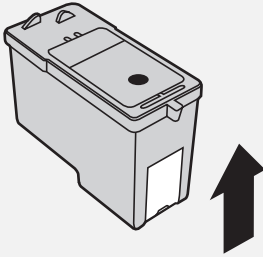

- 6** Using another clean section of the cloth, repeat the above step.
- 7** Allow the nozzles and contacts to dry completely.
- 8** Reinstall the print cartridge and repeat the nozzle cleaning procedure as explained in the previous section.
- If print quality is still not satisfactory after the nozzles are cleaned, replace the print cartridge (see page 9).

Cleaning the cartridge holder

A dirty print cartridge holder may cause smudges on your printed pages. To clean the print cartridge holder, open the cover and remove the print cartridge (see the procedure beginning on page 9). Wipe the part indicated below with a damp cloth.

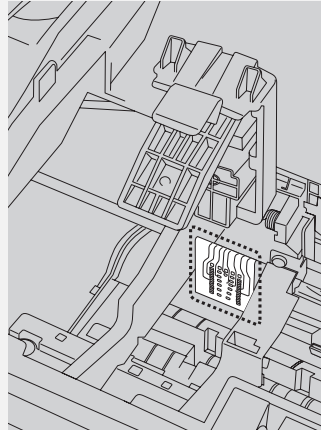

About the lithium battery:

The machine uses a lithium battery to retain settings and information programmed in the machine when the power is turned off. Battery power is consumed primarily when the power is off. With the power kept continuously off, the life of the battery is about 5 years. If the battery dies, have your dealer or retailer replace it. Do not try to replace it yourself.

10. Troubleshooting

Problems and Solutions

If you have any problems with the machine, first refer to the following troubleshooting guide. If you cannot solve the problem, call Sharp's Customer Assistance Center at 1-877-794-8675.

◆ For network connection problems (Fax to E-mail), see page 16.

Line error

Problem	Solution
LINE ERROR appears in the display.	<p>A line error occurs when your machine cannot communicate correctly with another fax machine. The error is usually due to a problem on the phone line. Try faxing again. If unsuccessful, check the following:</p> <ul style="list-style-type: none">• Check the connection. The cord from the TEL. LINE jack to the wall jack should be no longer than six feet.• Make sure there are no modem devices sharing the same telephone line.• Check with the other party to make sure their fax machine is functioning properly.• Have your telephone line checked for line noise.• Try connecting the machine to a different phone line.• If the error persists, the machine may need service.

Dialing and transmission problems

Problem	Solution
No dial tone when you pick up the handset or press the SPEAKER key.	<ul style="list-style-type: none">• Make sure the handset cord is connected to the correct jack. See <i>Connect the handset</i> on page 7.• Make sure that the telephone line is properly connected to both the TEL. LINE jack and the wall jack (see page 11).• Make sure that the telephone line is good.

<p>Dialing is not possible.</p>	<ul style="list-style-type: none"> • Make sure the power cord is properly plugged into a power outlet. • Make sure that the telephone line is properly connected to both the TEL. LINE jack and the wall jack (see page 11). • Make sure that the machine is set to the correct dialing mode for your telephone line. See the procedure on page 45 and “DIAL MODE” on page 46.
<p>The power is on, but no transmission takes place.</p>	<ul style="list-style-type: none"> • Make sure that the receiving machine has paper. • If the receiving machine is in manual mode with no attendant, reception will not be possible. • Check the display for error messages. • Pick up the handset and check for a dial tone. Dial the receiving machine manually and make sure that it is responding (you should hear a fax tone).
<p>Nothing is printed at the receiving end.</p>	<ul style="list-style-type: none"> • Make sure that the document for transmission is placed face down in the feeder.
<p>A distorted image is received at the other end.</p>	<ul style="list-style-type: none"> • Noise on the telephone line may cause distortion. Try sending the document again. • Make a copy of the document on your machine. If the copy is also distorted, your machine may need service.

Reception and copying problems

Problem	Solution
<p>The machine doesn't receive documents automatically.</p>	<ul style="list-style-type: none"> • Make sure that the reception mode is set to AUTO. If you subscribe to a distinctive ring service, make sure that the Distinctive Ring function is set to the correct ring pattern. If you do not subscribe to a distinctive ring service, make sure that Distinctive Ring is set to OFF SETTING. (See <i>Distinctive Ring</i> on page 39.)

Problems and Solutions

The printing paper comes out blank when you try to receive a document.	<ul style="list-style-type: none"> • Make sure that the document is loaded properly in the feeder of the transmitting machine. Make a copy or print a report to confirm the printing ability of your machine.
Print quality is poor.	<ul style="list-style-type: none"> • The print cartridge may need alignment or cleaning. See page 53.
The received document is faint.	<ul style="list-style-type: none"> • Ask the other party to send higher contrast documents. • The print cartridge may need replacement. Make a copy or print a report to check your machine's printing ability.
Received images are distorted.	<ul style="list-style-type: none"> • Noise on the telephone line may cause distortion. Have the other party try sending the document again. • Make a copy or print a report on your machine. If the copy or report is also distorted, your machine may need service.
The quality of copies is poor and/or dark vertical lines appear.	<ul style="list-style-type: none"> • Any dirt or material on the scanning glass will cause spots to appear on copies and transmitted faxes. Clean the scanning glass as explained on page 52.



General problems

Problem	Solution
Nothing appears in the display.	<ul style="list-style-type: none"> • Make sure the power cord is properly plugged into a power outlet. • Connect another electrical appliance to the outlet to see if it has power.
The machine does not respond when you press any of its keys.	<ul style="list-style-type: none"> • If a beep sound is not made when you press the keys, unplug the power cord and then plug it in again several seconds later.
Automatic document feeding does not work for transmission or copying.	<ul style="list-style-type: none"> • Check the size and weight of the document (see <i>Transmittable Documents</i> on page 24).

Messages and Signals

Display messages

Note: If you have turned on the Caller ID function, see page 38 for display messages related to Caller ID.

<p>ADD PAPER & / PRESS START KEY (alternating messages)</p>	<p>Check the printing paper. If the tray is empty, add paper and then press . If there is paper in the tray, make sure it is inserted correctly (take out the stack, align the edges evenly, and then reinsert it in the tray) and then press .</p>
<p>CHANGE CARTRIDGE</p>	<p>This message appears after you install or replace the print cartridge (see page 10).</p>
<p>CHECK CARTRIDGE</p>	<p>The print cartridge is missing and must be installed, or is not installed correctly.</p>
<p>CONNECTION ERROR</p>	<p>A Fax to E-mail transmission was not successful because of a communication problem on your local network. This is usually due to a problem with the cable connections. Make sure that the cable ends are securely inserted in the LAN ports. Make sure that the correct cable is being used and that the cable is good. Make sure that your router or hub is powered on.</p>
<p>CHECK E-MAIL SETTING</p>	<p>Fax to E-mail transmission is not possible because the SMTP server or the sender address has not been specified in the e-mail settings (see page 17).</p>
<p>DOCUMENT JAMMED</p>	<p>The original document is jammed. See the following section, <i>Clearing Paper Jams</i>. Document jams will occur if you load more than 20 pages at once or load documents that are too thick (see page 24). The document may also jam if the receiving machine doesn't respond properly when you attempt to send a fax.</p>
<p>FAX RX IN MEMORY</p>	<p>A fax has been received in memory because the print cartridge needs replacement, you have run out of printing paper, or the paper is jammed. The fax will print out automatically when the problem is fixed.</p>

Messages and Signals

INK NEAR EMPTY	The cartridge is nearly empty (approximately one eighth of the ink remains).
LINE ERROR	Transmission or reception was not successful. Press  to clear the message and then try again. If the error persists, see <i>Line error</i> on page 56.
LOW INK	The cartridge is low on ink (approximately one quarter of the ink remains).
MEMORY FULL	If faxes have been received to memory because printing is not possible, resolve the problem so that printing can continue (see <i>Reception to Memory</i> on page 33). If faxes are being held in memory because the Secure Receive function has been activated, print the faxes as explained on page 43. If you are attempting to broadcast or transmit from memory, see <i>If the memory becomes full</i> on page 36. If you are copying, see <i>If MEMORY FULL appears</i> on page 34.
OUT OF INK	The cartridge is out of ink and must be replaced. Faxes will be received to memory.
PAPER JAMMED	The printing paper is jammed. See page 62.
PRINTER ERROR	A printer error has occurred. Open the cover, make sure the print cartridge is installed correctly, and then close the cover.
PRINTER ERROR/ CHECK PAPER	A paper jam may have occurred. Follow the procedure on page 62 to clear the jam.
RECALLING	This appears if you attempt to send a fax by auto dialing and the line is busy or the receiving fax machine does not answer. Your machine will automatically reattempt the call. (See <i>Automatic redialing</i> on page 30.)
RECEIVED SECURE FAX	A received fax is being held in memory because the Secure Receive function has been activated. Enter your secure code to print the fax (see page 43).

SERVER ERROR	A Fax to E-mail transmission was not successful because the machine could not connect to your mail server or there was no response from the mail server. Make sure the SMTP server setting is correct (p. 18). If you have configured "POP before SMTP" settings in the Web pages, make sure these settings are correct. If [CABLE DISCONNECTED] appears on the bottom line, see "CONNECTION ERROR" on page 59.
SERVER NOT FOUND/ CABLE DISCONNECTED	See "CONNECTION ERROR" on page 59.
SERVER NOT FOUND/ DHCP	A Fax to E-mail transmission was not successful because the machine was unable to automatically obtain an IP address. Restart your router or other device that acts as your DHCP server.
SERVER NOT FOUND/ SMTP	A Fax to E-mail transmission was not successful because an incorrect host name is entered for your SMTP server. Check the SMTP server setting (p. 18).

Audible signals

Continuous tone	3 seconds	Indicates the end of transmission, reception, or copying.
Intermittent tone (3 beeps)	5 seconds (1 second on, 1 second off)	Indicates incomplete transmission, reception, or copying.

Clearing Paper Jams

Clearing Paper Jams

Clearing a jammed document

If the original document doesn't feed properly during transmission or copying, or [DOCUMENT JAMMED] appears in

the display, first try pressing . If the document doesn't feed out, remove it as explained below.

Important: Do not try to remove a jammed document without releasing it as explained below. This may damage the feeder mechanism.

- 1 Open the cover (1). Rotate the lever so that it points straight up (2), and pull it up (3). Pull the roller out to the right, and remove the document (4).

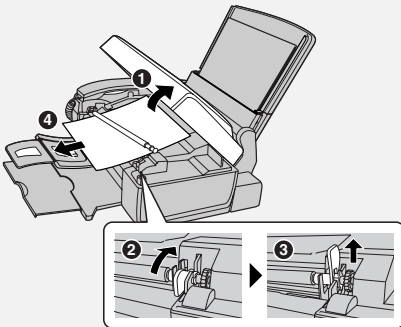

- 2 Replace the white roller, inserting the left end first. Push the lever down and rotate it back down (1). Close the cover, pressing firmly on both front corners (2).

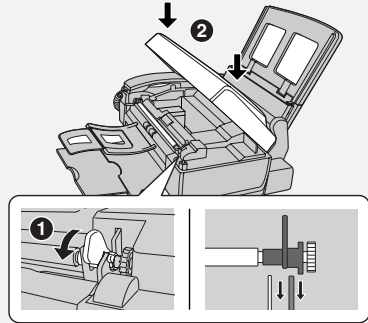

Clearing jammed printing paper

- 1 Open the cover (1). Pull the jammed paper forward or backward out of the machine as appropriate (2), taking care not to tear it.

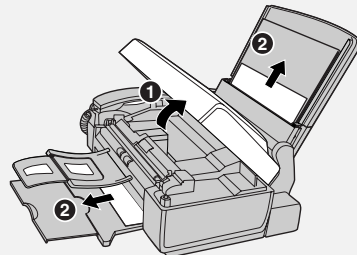

- 2 Close the cover, pressing down firmly on both front corners.

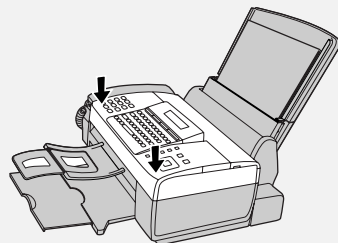

FCC Regulatory Information

This equipment complies with Part 68 of the FCC rules and the requirements adopted by the ACTA. On the rear of this equipment is a label that contains, among other information, a product identifier in the format US:AAAEQ##TXXXX. If requested, this number must be provided to the telephone company.

A plug and jack used to connect this equipment to the premises wiring and telephone network must comply with the applicable FCC Part 68 rules and requirements adopted by the ACTA. A compliant telephone cord and modular plug is provided with this product. It is designed to be connected to a compatible modular jack that is also compliant. See installation instructions for details. This equipment connects to the telephone network through a standard USOC RJ-11C network interface jack.

The REN is used to determine the number of devices that may be connected to a telephone line. Excessive RENs on a telephone line may result in the devices not ringing in response to an incoming call. In most but not all areas, the sum of RENs should not exceed five (5.0). To be certain of the number of devices that may be connected to a line, as determined by the total RENs, contact the local telephone company. For products approved after July 23, 2001, the REN for this product is part of the product identifier that has the format US:AAAEQ##TXXXX. The digits represented by ## are the REN without a decimal point (e.g., 03 is a REN of 0.3). For earlier products, the REN is separately shown on the label.

If this equipment causes harm to the telephone network, the telephone company will notify you in advance that temporary discontinuance of service may be required. But if advance notice isn't practical, the telephone company will notify the customer as soon as possible. Also, you will be advised of your right to file a complaint with the FCC if you believe it is necessary.

The telephone company may make changes in its facilities, equipment, operations or procedures that could affect the operation of the equipment. If this happens the telephone company will provide advance notice in order for you to make necessary modifications to maintain uninterrupted service.

If trouble is experienced with this equipment, or for repair or warranty information, please contact Sharp's Customer Assistance Center. The number is 1-877-794-8675. If the equipment is causing harm to the telephone network, the telephone company may request that you disconnect the equipment until the problem is resolved.

This equipment may not be used on coin service provided by the telephone company. Connection to party line service is subject to state tariffs. Contact the state public utility commission, public service commission or corporation commission for information.

If your home has specially wired alarm equipment connected to the telephone line, ensure the installation of this equipment ID does not disable your alarm equipment. If you have questions about what will disable alarm equipment, consult your telephone company or a qualified installer.

This equipment is hearing-aid compatible.

When programming and/or making test calls to emergency numbers:

- ◆ Remain on the line and briefly explain to the dispatcher the reason for the call.
- ◆ Perform such activities in the off-peak hours, such as early morning or late evening.

S H A R P

Date Revised: _____

Date Issued: Apr. 25, 2006

MATERIAL SAFETY DATA SHEET (1/3)

MSDS No. B-1029

Section 1. Product and Company Identification

Product Name : Ink cartridge of UX-C80B**Supplier Identification :** Sharp Corporation

22-22 Nagaïke-cho, Abeno-ku, Osaka, Japan

Local suppliers are listed below. Please contact the nearest supplier for additional information.

(Area)	(Country)	(Name and Telephone Number)
North America	U.S.A.	Sharp Electronics Corporation Telephone number for information: 1-800-237-4277 Emergency telephone number : 1-800-255-3924
	Canada	Sharp Electronics of Canada Ltd. Telephone number for information : 905-890-2100 Emergency telephone number : 1-800-255-3924

Section 2. Ingredients

Ingredients	Cas No.	Proportion	OSHA PEL	ACGIH TLV
Carbon Black	1333-86-4	1-5	3.5 mg/m ³ TWA	3.5 mg/m ³ TWA
Acrylic Terpolymer	Trade Secret(#)	0.1-2	None	None
Water Soluble Organic Solvents	Trade Secret(#)	10-20	None	None
Hydroxylated Alkane NJTSRN 80100451-5004	Trade Secret(#)	1-10	None	None
Water	7732-18-5	60-78	None	None

: Supplier's confidential information

Section 3. Hazardous Identification

The following information from our supplier is based on testing of the product as a whole and/or characteristics of components.

Hazard Information : Primary Routes of Exposure: Ingestion, skin contact.**Inhalation :** If ink mist is inhaled, respiratory tract irritation may occur. Exposure not probable with intended use.

No adverse chronic effects known at intended level of use.

Skin Contact : Not an irritant. Exposure not probable with intended use. Not a dermal sensitizer.**Eye Contact :** Not an irritant. Exposure not probable with intended use.**Ingestion :** Low acute oral toxicity. Exposure not probable with intended use.

Section 4. First-Aid Measures

Inhalation: If symptoms, such as shortness of breath or persistent coughing are experienced, remove source of contamination and move individual to fresh air. If symptoms persist, seek medical attention.**Skin Contact:** Wash with soap and water. Should irritation occur, seek medical attention.**Eye Contact:** Flush immediately with plenty of water. Remove contact lenses and continue flushing for at least 15 minutes.

If irritation develops and persists, seek medical attention.

Ingestion: Immediately wash mouth out with plenty of water. Do not induce vomiting. Slowly dilute with 1-2 glasses of water or milk and seek medical attention. Never give anything by mouth to an unconscious person.**Aggravated Conditions :** None known**Notes to Physician :** No specific antidote.

Section 5. Fire-Fighting Measures

Flash Point/Range (C) : Not applicable**Autoignition Temperature (C) :** Not determined**Flammable Limits in Air UEL :** Not determined**Flammable Limits in Air LEL :** Not determined**Extinguishing Media :** Carbon dioxide, water spray or fog, dry chemical or foam**Hazardous Combustion Products :** Carbon monoxide, carbon dioxide, unidentified organics**Special Exposure Hazards :** None known**Special Protective Equipment :** NIOSH approved self contained breathing apparatus may be required if a large number of cartridges are involved.**NFPA Rating :** Health: 1 Flammability: 0 Reactivity: 0**HMIS Classification :** Health: 1 Flammability: 0 Reactivity: 0

S H A R P

Date Revised: _____

Date Issued: Apr. 25, 2006

MATERIAL SAFETY DATA SHEET (2/3)

MSDS No. B-1029

Section 6. Accidental Release Measures

Personal Precautionary Measures : None required for intended use in printer.
Environmental Precautionary : Unless specifically permitted for disposal, keep waste out of sewers, watersheds, and waterways.
Procedure for Cleaning/ Absorption : Absorb small spills with cloth or paper towels or other suitable material. Place in container for disposal. For large spills, dike around spill with absorbent material. Wash spill site with soap and water after material pickup is complete. Disposal is subject to federal, state, local, or provincial regulations.

Section 7. Handling and Storage

Handling : To avoid damage to cartridge and accidental contact with ink
KEEP OUT OF REACH OF CHILDREN.
Storage : Store in a cool, dry place.

Section 8. Exposure Control/Personal Protection

Engineering Controls : None required.
Respiratory Protection : None required for intended use in printer.
Gloves : None required for intended use in printer.
Skin Protection : None required for intended use in printer.
Eyes : None required for intended use in printer.

Section 9. Physical and Chemical Properties

Physical State:	Cartridge contains liquid ink	Pressurized:	No
Color :	Black	pH:	7.0-8.5
Odor:	Faint	Specific Gravity:	Approx. 1.0
Solubility in Water:	Fully Miscible	Specific Gravity:	Approx. 1.0

Section 10. Stability and Reactivity

Chemical Stability : Stable
Hazardous Polymerization : Will not occur
Conditions to Avoid : None known
Materials to Avoid : None known
Hazardous Decomposition Products : Carbon monoxide, carbon dioxide, unidentified organics
Additional Guidelines : None

Section 11. Toxicological Information

Primary Routes of Exposure : Ingestion, skin contact.
Ingestion : Low acute oral toxicity. Exposure not probable with intended use. Based on component characteristics, gastrointestinal, liver, kidney, and CNS effects are possible if large quantities of ink are ingested.
Acute Toxicity Oral Rat LD50(mg/kg) : >2000
Inhalation : Low acute inhalation toxicity. Pure carbon black, a minor component of this product, has been listed by IARC as a group 2B (possible carcinogen). This classification is based on rat "lung particulate overload" studies performed with airborne particulate carbon black. Toner is not listed by IARC, NTP, or OSHA.
Aggravated Conditions : None known
Carcinogenicity Comment : Neither this product nor any of its components present above 0.1% are listed by IARC, NTP, or OSHA as known carcinogens.

Section 12. Ecological Information

Mobility : Not determined
Persistence : Not determined
Bioaccumulative : Not determined
Other Information : None

S H A R P

Date Revised: _____

Date Issued: Apr. 25, 2006

MATERIAL SAFETY DATA SHEET (3/3)

MSDS No. B-1029

Section 13. Disposal Consideration

Waste Disposal:

This product is not a listed hazardous waste in accordance with Federal Regulation 40 CFR Part 261. If discarded in its purchased form, this product would not be a hazardous waste either by listing or by characteristic. However, under RCRA, it is the responsibility of the product user to determine at the time of disposal whether a material has been contaminated and should be classified as a hazardous waste. Disposal is subject to local, state and federal regulations.

Section 14. Transport Information

DOT Status : Not classified as a hazardous material or substance under US DOT.
DOT Shipping Name : Not applicable **DOT Reportable Quantity :** Not applicable
Hazard Class : Not applicable **DOT Packing Group :** Not applicable

Section 15. Regulatory Information

TSCA (USA) All ingredients are listed on the Toxic Substances Control Act (TSCA) inventory, have been registered, or are exempt.

SARA / EPCRA (USA) : None of the ingredients in this product has a final reportable quantity (RQ) under Emergency Planning and Community Right-to Know Act (EPCRA)- Section 302 : Extremely Hazardous Substances (EHS) or notification requirements for EHS under Section 304.

California Proposition 65 : This product contains no known materials at levels which the State of California has found to cause cancer, birth defects or other reproductive harm - California Proposition 65.

DSL (Canada) : All ingredients are listed on the Canadian Domestic Substances List (DSL), have been registered on the Non-Domestic Substances List (NDL), or are exempt.

EINECS (Europe) : All ingredients are listed on the European Inventory of Existing Commercial Substances (EINECS) list, have been registered on the European List of New Chemical Substances (ELINCS), or are exempt.

ENCS (Japan) : All ingredients are listed on the Japanese Existing and New Chemical Substances (ENCS) list, have been registered, or are exempt.

AICS (Australia) : All ingredients are listed in Australian Inventory of Commercial Substances (AICS), or are registered in Australia.

ECL (Korea) : All ingredients are listed on the Korean Existing Chemicals List (ECL), have been registered, or are exempt.

WHMIS Hazard Class (Canada) : Not a WHMIS controlled product.

Section 16. Other Information

Reference : IARC(1996): IARC monographs on the Evaluation of the Carcinogenic Risk of Chemicals to Humans, Vol. 65, Printing Process and Printing Inks, Carbon Black and Some Nitro Compounds, Lyon, pp.149-261
H.Muhle, B.Bellmann, O.Creutzenberg, C.Dasenbrock, H.Ernst, R.Kilpper, J.C.MacKenzie, P.Morrow, U.Mohr, S.Takenaka, and R.Mermelstein(1991) Pulmonary Response to Toner upon Chronic Inhalation Exposure in Rats. Fundamental and Applied Toxicology 17, pp.280-299.

Restrictions : This information relates only to the specific material designated as supplied by the manufacturer. This information is supplied to us by the manufacturer and Sharp offers no warranties as to its accuracy and accepts no responsibilities for any typographical errors which may appear on these sheets. The information on this data sheet represents best opinion as to the proper use in handling of this product under normal conditions. However, all materials may present unknown hazards and should be used with caution. Although certain hazards are described herein, we do not guarantee that these are the only hazards which exist. It is the responsibility of the user to determine the suitability of this product for each particular use.

Revision Information :

2006/Apr./25 Not applicable in this time due to new issue.

Quick Reference Guide

Fax / Fax to E-mail Transmission

Place your document (up to 20 pages) face down in the document feeder.

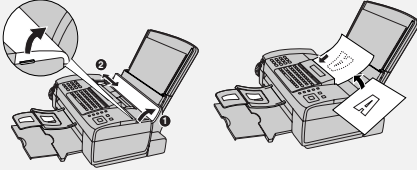

Sending a Fax by Normal Dialing



- 1 Lift the handset or press  .
- 2 Dial the fax number.
- 3 Wait for the reception tone (if a person answers, ask them to press their Start key).

- 4 Press  .



Using a Rapid Key (fax/e-mail)

Press the Rapid Key for the destination.

Using a Speed Dial number (fax/e-mail)

- 1 Press  .
- 2 Enter the appropriate 2-digit Speed Dial number and press  .

Searching for a destination (fax/e-mail)

- 1 Press  or  until the desired destination appears.
- 2 Press  .

Receiving Faxes

Press  until the desired reception mode appears in the display.









AUTO mode: The machine automatically answers and receives faxes.

MANUAL mode: Answer all calls (even faxes) by picking up the handset. To

begin fax reception, press  .

TEL/FAX mode: The machine automatically answers and receives faxes. Voice calls are signalled by a special ringing sound.

Storing Destinations

- 1 Press  ,  , then  .
- 2 Press an unused Rapid Key, or press  and enter an unused 2-digit Speed Dial number (01 to 63). (For an e-mail destination, you can also press the **A**, **B** or **C** key and go to Step 4.)
- 3 Press  for fax or  for e-mail.
- 4 Enter the fax number or the e-mail address.
- 5 Press  .
- 6 Enter a name with the letter keys.
- 7 Press  and then  .

Guía de referencia rápida

Transmisión de Fax / de Fax a correo electrónico

Coloque el documento (hasta 20 páginas) mirando hacia abajo en el alimentador.

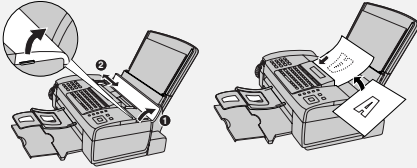

Cómo enviar un fax por marcación normal



- 1 Levante el auricular u oprima  .
- 2 Marque el número de fax.
- 3 Espere a escuchar el tono de recepción (si alguien contesta el teléfono, pídale que oprima la tecla Start).

4 Oprima  .



Cómo utilizar la Tecla rápida (fax/correo electrónico)

Oprima la Tecla rápida para el número deseado.

Cómo utilizar un número de Marcación abreviada (fax/correo electrónico)

- 1 Oprima  .
- 2 Introduzca el número de 2 dígitos de marcación abreviada apropiado y oprima  .

Cómo buscar un número (fax/correo electrónico)

- 1 Oprima  o  hasta que aparezca el número deseado.
- 2 Oprima  .

Cómo recibir faxes

Oprima  hasta que aparezca el modo de recepción deseado en el display.









Modo AUTO: El contestador automáticamente contesta las llamadas y recibe faxes.

Modo MANUAL: Contesta todas las llamadas (incluso las de telefax) levantando el auricular. Para que comience la recepción del documento,

oprime  .

Modo TEL/FAX: El contestador automáticamente contesta las llamadas y recibe faxes. Las llamadas de voz se indican con un sonido de timbre especial.

Cómo programar números

- 1 Oprima  ,  , y a continuación  .
- 2 Oprima una tecla rápida no utilizada, u oprima  e introduzca un número de marcación abreviada de 2 dígitos no utilizado (01a 63). (Para programar una dirección de correo electrónico, también puede oprimir las teclas **A**, **B** o **C** y continuar en el Paso 4.)
- 3 Oprima  para fax o  para correo electrónico.
- 4 Introduzca el número de fax o la dirección de correo electrónico.
- 5 Oprima  .
- 6 Introduzca un nombre con las teclas de letras.
- 7 Oprima  y a continuación  .

Index

A

Anti Junk Fax, 40
Audible signals, 61
Auto Print Out (of Activity Report), 47
AUTO reception mode, 13, 32
Auto-dial numbers
 Storing, 27
 Using, 29

B

Batch page numbering, 31
Broadcasting, 35

C

Caller ID, 37
Caller ID list, 38, 50
Contrast, 25
Copies, 34

D

Date, setting, 12
Day Light Saving setting, 47
Destination List, 50
Dial Mode, 46
Dial tone detection, 48
Dialing
 Automatic redialing, 30
 Direct Keypad, 30
 Normal, 26
 Rapid Key, 29
 Redialing, 30
 Search, 29
 Speed, 29
Direct Keypad Dialing, 30
Display messages, 38, 59
Distinctive ring, 39
Document feeder, 24
Document restrictions, 24
Document sizes, 24
Duplex Scan, 40

E

ECM mode (Error Correction Mode), 47
E-mail addresses, storing, 19
E-mail message, 18, 21
E-mail options, 21
E-mail settings, 17, 18
E-mail subject, 18, 21

F

Fax Signal Receive, 47
Fax to E-mail transmission, 20
File format, 18, 21
File name, 22
Fine Priority setting, 45

G

Group Keys, storing, 36
Group keys, using, 36
Group List, 50

H

Halftone setting, 25
Handset, 7
Handset receiver volume, 13
Hold, 33
Housing, cleaning, 53

I

Ink Save Mode, 49
IP address, 15, 23

J

Jams, clearing, 62

K

Key Tone setting, 48

L

Language setting, 48
Letters, entering, 6

Line error, 56
 Loading paper, 8
 Loading the document, 24

M

MANUAL reception mode, 13, 32
 Memory full, 60
 Memory, substitute reception to, 33

N

Network
 Cable, 14
 Checking connection, 15
 Connecting to, 14
 Problems, 16
 Network Setting List, 50
 Network settings, configuring, 23
 Network settings, initializing, 23
 Normal Dialing, 26
 Number of Rings setting, 45

O

Ordering parts, 63

P

Packing tape, removing, 7
 Page numbering, batch, 31
 Paper jams, clearing, 62
 Paper size setting, 49
 Paper, loading, 8
 Power cord, 9
 Print cartridge
 Aligning, 53
 Cleaning nozzles, 53
 Installing, 9
 Wiping nozzles, 54
 Print cartridge holder, wiping, 55
 Pseudo Ring, 46

Q

Quality Mode setting, 49

R

Rapid Key Dialing, 29
 Rapid Key, using for e-mail, 21
 Receive Fax to E-mail, 41
 Receive Fax to E-mail List, 50
 Receive Ratio setting, 48
 Reception mode
 AUTO, 13, 32
 MANUAL, 13, 32
 TEL/FAX, 13, 33
 Redialing, 30
 Redialing, automatic, 30
 Removing original document, 25
 Resolution, 25
 Ringer volume, 13

S

Scanning glass, cleaning, 52
 Search Dialing, 29
 Searching for stored e-mail address, 21
 Secure Receive, 43
 Sender address, 18
 Sender name, 18
 Sender's name and fax number,
 entering, 11
 Setup List, 50
 SMTP server, 18
 Sort Copy, 49
 Speaker volume, 13
 Speed Dial number, using for e-mail, 21
 Speed Dialing, 29

T

TEL. LINE jack, 11
 TEL/FAX reception mode, 13, 33
 Telephone line cord, 11
 Time, setting, 12
 Transaction Report, 51
 Setting print condition, 46

V

Voice calls, 29

Index

W

Web page in machine, 17

LIMITED WARRANTY

SHARP ELECTRONICS CORPORATION warrants to the first end user purchaser that this Sharp brand product (the "Product"), when shipped in its original container, will be free from defective workmanship and materials, and agrees that it will, at its option, either repair the defect or replace the defective Product or part thereof with a new or remanufactured equivalent at no charge to the purchaser for parts or labor for the period(s) set forth below.

This warranty does not apply to any appearance items of the Product nor to the additional excluded item(s) set forth below nor to any product the exterior of which has been damaged or defaced, which has been subjected to misuse, abnormal service or handling, or which has been altered or modified in design or construction.

In order to enforce the rights under this limited warranty, the purchaser should follow the steps set forth below and provided proof of purchase to the servicer.

To the extent permitted by applicable state law, the warranties set forth herein are in lieu of, and exclusive of, all other warranties, express or implied. Specifically, ALL OTHER WARRANTIES OTHER THAN THOSE SET FORTH ABOVE ARE EXCLUDED. ALL EXPRESS AND IMPLIED WARRANTIES INCLUDING THE WARRANTIES OF MERCHANTABILITY, FITNESS FOR USE, AND FITNESS FOR A PARTICULAR PURPOSE ARE SPECIFICALLY EXCLUDED. If, under applicable state law, implied warranties may not validly be disclaimed or excluded, the duration of such implied warranties is limited to the period(s) from the date of purchase set forth below.

Neither the sales personnel of the seller nor any other person is authorized to make any warranties other than those described above, or to extend the duration of any warranties beyond the time period described above on behalf of Sharp.

The warranties described herein shall be the sole and exclusive warranties granted by Sharp and shall be the sole and exclusive remedy available to the purchaser. Correction of defects, in the manner and for the period of time described herein, shall constitute complete fulfillment of all liabilities and responsibilities of Sharp to the purchaser with respect to the Product, and shall constitute full satisfaction of all claims, whether based on contact, negligence, strict liability or otherwise. In no event shall Sharp be liable, or in any way responsible, for any damages or defects in the Product which were caused by repairs or attempted repairs performed by anyone other than an authorized servicer. Nor shall Sharp be liable or in any way responsible for any incidental or consequential economic or property damage. Some states do not allow limits on warranties or on remedies for breach in certain transactions; in such state the limits herein may not apply.

Your Product:

Warranty Period for this Product:

Additional items excluded from warranty coverage:

Where to obtain service:

What to do to obtain service:

Personal Facsimile

Ninety (90) days parts and labor from date of purchase.

Any consumable items such as paper supplied with the Product.

At a Sharp Authorized Servicer located in the United States.

To find out the location of the nearest Sharp Authorized Servicer, call Sharp toll free at 1-877-794-8675.

Ship (prepaid) or carry in your Product to a Sharp Authorized Servicer.

Be sure to have proof of purchase available. If you ship or mail the Product, be sure it is packaged carefully.

For product information or customer assistance, please visit <http://www.sharppusa.com> on the World Wide Web or call **1-877-794-8675**.

SHARP ELECTRONICS CORPORATION

Sharp Plaza,

Mahwah, New Jersey 07430-1163

SHARP®

SHARP ELECTRONICS CORPORATION

Sharp Plaza, Mahwah, New Jersey 07430-1163

<http://www.sharpusa.com>

SHARP CORPORATION

FOR YOUR RECORDS

Please record the model number and serial number below, for easy reference, in case of loss or theft. These numbers are located on the rear side of the unit. Space is also provided for other relevant information.

Model Number	UX-B800SE
Serial Number	_____
Date of Purchase	_____
Place of Purchase	_____

PRINTED IN THAILAND
(TINSE4521XHTB)

Free Manuals Download Website

<http://myh66.com>

<http://usermanuals.us>

<http://www.somanuals.com>

<http://www.4manuals.cc>

<http://www.manual-lib.com>

<http://www.404manual.com>

<http://www.luxmanual.com>

<http://aubethermostatmanual.com>

Golf course search by state

<http://golfingnear.com>

Email search by domain

<http://emailbydomain.com>

Auto manuals search

<http://auto.somanuals.com>

TV manuals search

<http://tv.somanuals.com>