

# SHARP

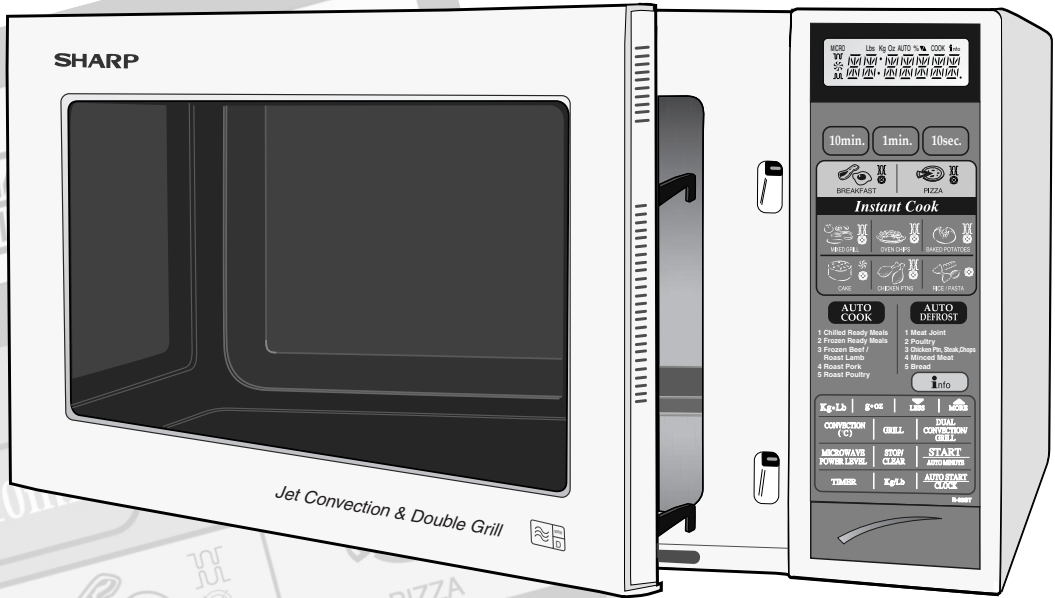

## R-82STM MICROWAVE OVEN WITH TOP & BOTTOM GRILLS AND CONVECTION

### OPERATION MANUAL WITH COOKERY BOOK

**900W (IEC 705)**





Contents . . . . .	1
<b>Oven and Accessories</b> . . . . .	2
<b>Control Panel</b> . . . . .	3
<b>Safety:</b>	
Important Safety Instructions . . . . .	4
Installation . . . . .	4-5
Before Operation . . . . .	5
<b>Operation:</b>	
Setting the Clock . . . . .	6
Microwave Power Levels . . . . .	7
Maff Heating Category . . . . .	7
Microwaving - Introduction . . . . .	8
How to Operate the Oven . . . . .	8
Microwave Defrosting . . . . .	9
Convection Cooking . . . . .	9
Preheating the oven . . . . .	10
Grilling . . . . .	10-11
Dual Cooking . . . . .	11-13
Pizza/Pizza Chart . . . . .	14
Breakfast/Breakfast Chart . . . . .	15
Instant Cook . . . . .	16
Instant Cook Chart . . . . .	17
Auto Cook / Auto Defrost . . . . .	18
Auto Cook Chart . . . . .	19-20
Auto Defrost Chart . . . . .	20
Other Convenient Functions . . . . .	21-25
<b>Cooking Advice:</b>	
Suitable Cookware . . . . .	26-27
Food Handling & Preparation . . . . .	27-28
Advice For Defrosting . . . . .	29
Advice For Reheating . . . . .	30
<b>Cookery Book:</b>	
<b>Aftercare:</b>	
Cleaning & Maintenance . . . . .	60
Troubleshooting . . . . .	61-62
To replace the mains plug . . . . .	62
Calling for Service . . . . .	63
Guarantee . . . . .	63
Specifications . . . . .	64

## OPERATION MANUAL

This operation manual contains important information which you should read carefully before using your microwave oven.

**IMPORTANT:** There may be a serious risk to health if this operation manual is not followed or if the oven is modified so that it operates with the door open.



# OVEN AND ACCESSORIES

- 1 Grill heating element (top grill)
- 2 Oven lamp
- 3 Control panel
- 4 Door opening button
- 5 Waveguide cover
- 6 Oven cavity
- 7 Turntable motor shaft
- 8 Grill heating element (bottom grill)
- 9 Door seals and sealing surfaces
- 10 Air-vent openings
- 11 Outer cabinet
- 12 Power cord

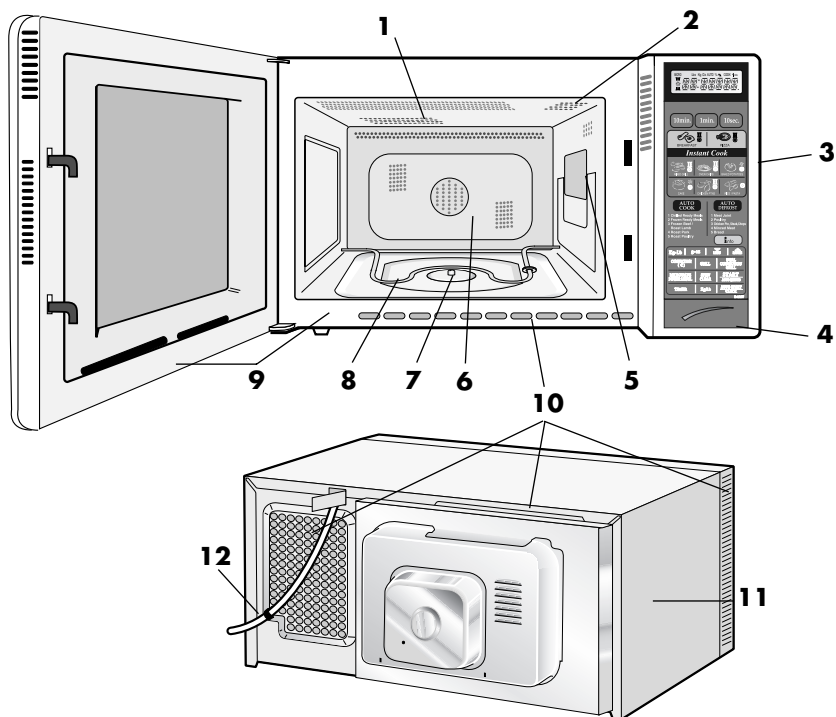

## ACCESSORIES:

Check to make sure the following accessories are supplied:

- 1 Turntable    2 Turntable support
- 3 Low Rack    4 High Rack    5 Splash Guard

- Ensure the lower grill is in the position shown.
- Fit the turntable support to the turntable motor shaft located on the floor of the oven cavity.
- Place the turntable on to the turntable support.
- **Never touch or move the lower grill when it is hot.**

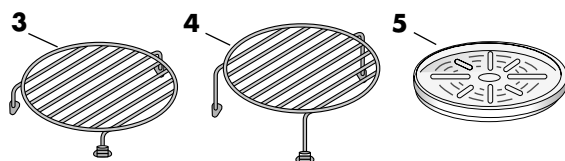
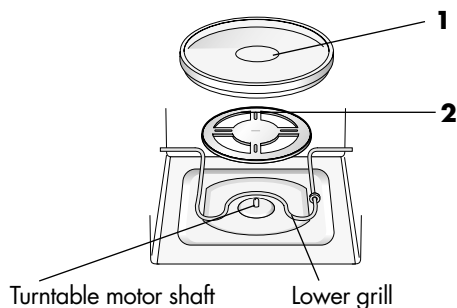

For use see page 10-11.

**NOTE:** When you order accessories, mention the Model and part name to your dealer or SHARP authorised service facility

## ! WARNING:

The accessories become very hot during Grill, Convection, Dual, Pizza, Breakfast, Instant Cook and Auto Cook modes. To prevent burns, use thick oven gloves when removing food or the turntable from the oven.

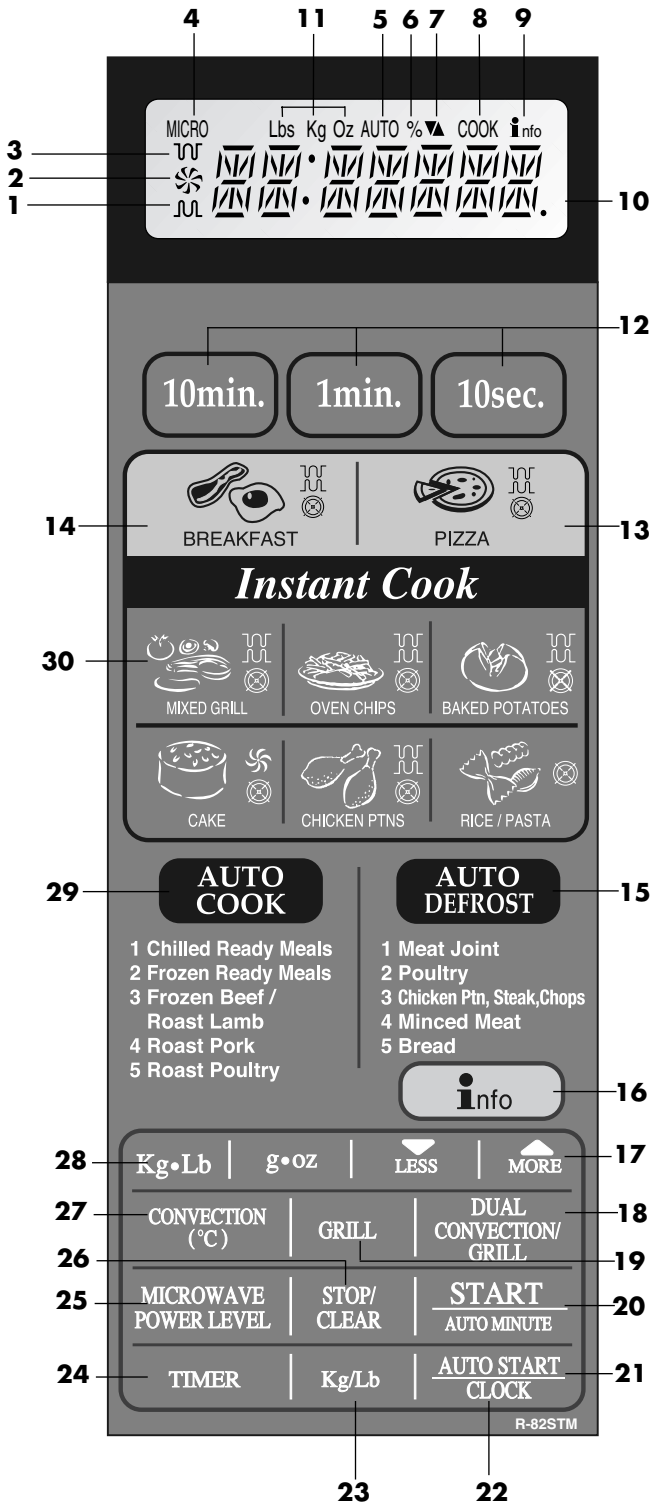

## DIGITAL DISPLAY

- 1 **BOTTOM GRILL** indicator.
- 2 **CONVECTION** indicator.
- 3 **TOP GRILL** indicator.
- 4 **MICROWAVE** indicator.
- 5 **AUTO** indicator, showing auto cooking in progress. (see page 18).
- 6 % percentage microwave power level indicator (See page 7).
- 7 **LESS/MORE** indicators (see page 23).
- 8 **COOK** indicator showing oven in operation.
- 9 **INFO** indicator for interactive display (See pages 24-25).
- 10 **DIGITAL DISPLAY**.
- 11 **WEIGHT** indicators.

## CONTROL PANEL

- 12 **TIME** keys. Use to select cooking times.
- 13 **PIZZA** key. Press to cook pizza (See page 14).
- 14 **BREAKFAST** key. (See page 15).
- 15 **AUTO DEFROST** key (See page 18-20).
- 16 **INFO** key for interactive display (See pages 24-25).
- 17 **LESS/MORE** keys. Press to shorten or lengthen heating time (See pages 23).
- 18 **DUAL CONVECTION/GRILL** key. Press to select Dual Convection or Dual Grill.
- 19 **GRILL** key. Press to select Grill (See page 10).
- 20 **START/AUTO MINUTE** key. Press to start a programme. Press to cook on (HIGH) for 1 minute or increase time during cooking in multiples of 1 minute (See page 22).
- 21 **AUTO START** key.
- 22 **CLOCK** key. Use to set the clock (See page 6).
- 23 **WEIGHT CONVERSION** key.
- 24 **TIMER** key.
- 25 **MICROWAVE POWER LEVEL** key. Press to select microwave power level, (See page 7).
- 26 **STOP/CLEAR** key. Press once to stop a programme, and/or twice to cancel a programme. (see page 5).
- 27 **CONVECTION TEMPERATURE** key.
- 28 **WEIGHT** keys.
- 29 **AUTO COOK** key (See pages 18-20).
- 30 **INSTANT COOK** keys. (See pages 16-17).



## IMPORTANT SAFETY INSTRUCTIONS

### IMPORTANT: PLEASE READ CAREFULLY AND KEEP FOR FUTURE REFERENCE

#### Oven Use:

- The oven is for domestic food preparation only. Never operate when empty, except as directed in the operation manual (see page 5).
- Do not leave or store anything inside the oven when not in use.
- Never attempt to use the oven with the door open. It is important not to defeat or tamper with the door safety latches. This may result in exposure to microwave energy.
- Never operate the oven with any object caught in the door sealing surfaces, this again may cause microwave leakage.
- Do not insert fingers or objects in the holes of the door latches or air-vent openings as this may damage the oven and cause an electric shock.
- If water or food drops inside the air vent openings switch off the oven immediately, unplug it and call a Service Technician appointed by SHARP.
- Never attempt to move the oven while it is operating.
- Do not hold the lower grill heater up other than for cleaning.

#### Childcare:

**Warning:** Only allow children to use the oven without supervision when adequate instructions have been given so that the child is able to use the oven in a safe way and understands the hazards of improper use.

Do not allow anyone to play with the oven, or lean or swing on the oven door.

**Pacemaker:** If you have a heart pacemaker, consult your doctor or the pacemaker manufacturer prior to oven use.

**Fire: If smoke is observed, switch off and unplug the appliance and keep the door closed in order to stifle any flames.**

**Microwave heating of beverages can result in delayed eruptive boiling, therefore care has to be taken when handling the container; stir liquid prior to and during heating/reheating, let liquid stand in the oven after heating.**



## INSTALLATION

### ⚠ WARNING:

#### Inspect the Oven:

**Check the oven carefully for damage before and regularly after installation.**

- **Make sure the door closes properly, that it is not misaligned or warped.**
- **Check the hinges and door safety latches are not broken or loose.**
- **If the door or door seals are damaged, the oven must not be operated until it has been repaired by a competent person.**
- **Inspect the oven interior and door for dents.**

#### Important:

**If any damage is apparent, do not operate the oven in any way. Contact your dealer or an authorised Service Technician appointed by SHARP.**

1. Remove all packing materials including the feature sticker. Do not remove the plastic film from the inside of the oven window as this protects it from dirt.

2. Place oven on a secure, level surface, strong enough to take the oven weight, plus the heaviest item likely to be cooked in the oven.
3. Do not place the oven where heat, moisture or high humidity are generated, (for example, near or above a conventional oven) or near combustible materials (for example, curtains). Do not block or obstruct air vent openings, as obstructions may ignite due to the emission of hot air.
4. The oven door may become hot during cooking.

The oven must be placed on a flat stable surface 85cm above floor level with a minimum of free space above the

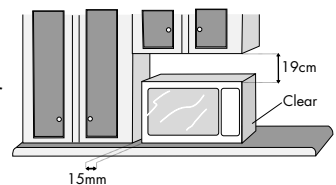

oven of 19cm. This oven has been specifically designed to be operated away from the wall with a minimum clearance of 15mm between one side of the oven and adjacent wall. The other side of the oven should be left clear of any obstruction.



5. Make sure the power supply cord is undamaged (See Installation next page) and that it does not run under the oven or over any hot or sharp surfaces.
6. The socket must be readily accessible so that it can be easily unplugged in an emergency.
7. Do not use the oven outdoors.

## BUILDING-IN-KIT

An installation frame is available which enables the microwave oven to be integrated within a kitchen unit.

The microwave oven is not designed to be built above or near a conventional oven.

SHARP recommend the use of the build in kit, **EBR-47ST**, available from your SHARP dealer. Only the use of this frame will guarantee the quality and safety of the oven. When building, follow installation instructions supplied carefully.

## IMPORTANT ELECTRICAL CONNECTION

- Do not allow water to come into contact with the power supply cord or plug.
- Insert the plug properly into the socket as the plug may otherwise overheat and catch fire.
- Do not connect other appliances to the same socket using an adaptor plug as it may cause the house wiring to overheat and catch fire.
- If the plug or socket is loose or the power supply cord is damaged, it must be replaced with a special cord. The exchange must be made by an authorised SHARP service agent. A defective plug, power supply cord or socket may overheat and catch fire during operation or cause an electrical shock.

- When removing the plug from the socket always grip the plug, never the mains lead as this may damage the power supply cord and the connections inside the plug.
- The product is fitted with a re-wireable plug. Should it not be suitable for the socket outlet in your home, remove the plug and fit an appropriate type, observing the wiring code on page 63.

If you wish to remove or replace the plug supplied, ensure the plug is removed properly and not cut off. When replacing the plug please ensure that you use a BSI or ASTA approved plug to BS1363, this should be fitted with a brown coloured 13 amp fuse approved by BSI or ASTA to BS1362. If you have any doubt about electrical connection seek the help of a qualified electrician.

## WARNING - IMPORTANT NOTE

Please note both the Operation Manual and Cookery Book supplied specify 900W (IEC 705) microwave output power. This applies only when the oven is operated on a 230-240V supply.

If your supply is less than 230-240V, it may be necessary to increase the cooking time when following the Operation Manual and Cookery Book instructions.

## WARNING: THIS APPLIANCE MUST BE EARTHED



To wire an appropriate plug, follow the wiring code on page 63.

# BEFORE OPERATION

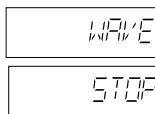
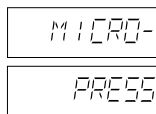
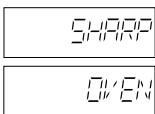

**STOP/CLEAR** key

Plug in the oven.

1. The oven display will flash the message shown opposite.
2. Press the **STOP/CLEAR** key.
3. Set the clock, refer to the next page.
4. Heat the oven using the top and lower grills without food for 20 minutes. (For operation, see NOTES on page 11).

**Use the STOP/CLEAR** key to:

1. Erase a mistake during programming.
2. Stop the oven temporarily during cooking.
3. Cancel a programme during cooking, press twice.



## SETTING THE CLOCK

Your oven is fitted with a 12 hour clock.

To set the time of day, follow the guidelines given in the example below:

### EXAMPLE:

To set the time of day, 12:35.

1. Press the **AUTO START/CLOCK** key once.
2. Enter the hours, by pressing the **10 MIN** key once and the **1 MIN** key twice.
3. Press the **AUTO START/CLOCK** key again.

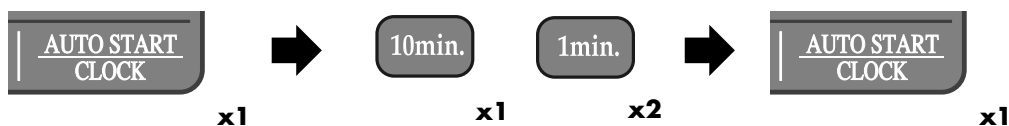

4. Enter the minutes by pressing the **10 MIN** key three times and the **1 MIN** key five times.
  5. Press the **AUTO START/CLOCK** key again to set the clock.
- Check the display.**



### NOTES:

- Once the time of day is set, you need only reset when the clocks change, if there is a power cut or if you disconnect the oven from the power socket.
- If the clock is set and cooking is complete, the display will return to show the correct time of day. If the clock has not been set, the display will show:

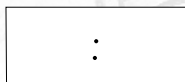



# MICROWAVE POWER LEVELS



## To operate the microwave function:

- Enter the required cooking/defrosting time.
- Select the power level by pressing the **MICROWAVE POWER LEVEL** key.  
There are 5 microwave power levels (see below).
- Press **START/AUTO MINUTE** key.

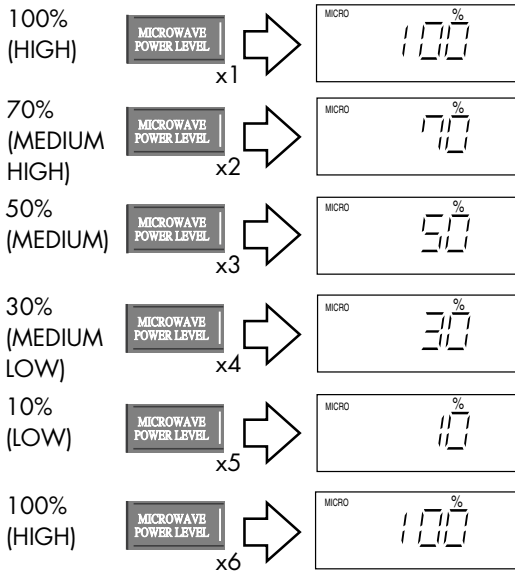

## IMPORTANT:

The microwave power level will default to 100% (HIGH) unless you press the **MICROWAVE POWER LEVEL** button to the desired setting. To help you decide which power level is suitable, refer to the charts in the Cookery Book section.

## For advice on:

DEFROSTING  
MICROWAVE COOKING  
GRILLING  
DUAL GRILLING  
CONVECTION  
MICROWAVE REHEATING

## See page(s):

Page 32  
Page 33  
Page 35  
Page 36  
Page 39  
Page 40

## NOTES:

- To check the microwave power level during cooking/defrosting press the **MICROWAVE POWER LEVEL** key. The power level will be displayed as long as the key is pressed. This does not affect the programme or cooking time.
- **Power level:** The microwave power level is varied by the microwave energy switching on and off. When using the power levels other than 100% (HIGH) you will be able to hear the microwave energy pulsing on and off as the food cooks or defrosts.

# MAFF HEATING CATEGORY

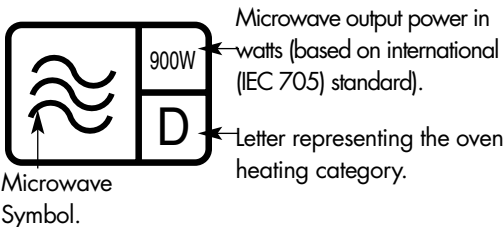

Model R-82STM has a microwave output power of 900 Watts; heating category D.

The heating category (a letter A to E) was developed by MAFF (Ministry of Agriculture, Fisheries and Food) with microwave oven and food manufacturers and indicates the ability of the oven to heat small quantities of food (up to 500g [1lb 2oz]). It does not represent the general performance of the oven.

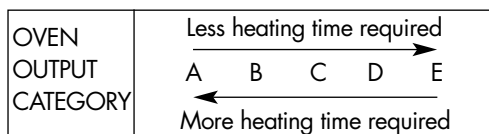
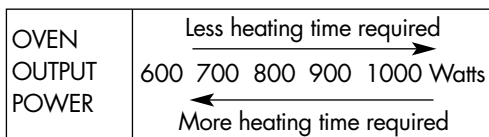

Food packs carry cooking instructions for heating categories A to E. Follow instructions for the letter corresponding to the oven's heating category. The higher the output power and heating category of the oven the less heating time is required. As shown opposite.



## MICROWAVING - INTRODUCTION

Water, sugar and fat in food absorb microwaves and causes their molecules to vibrate. This creates heat by friction, in the same way your hands get warm when you rub them together.

The outer areas of food are heated by microwave energy and the remaining portions by conduction. It is important to **turn, rearrange** or **stir** food to ensure even heating. Where recommended, allow food to stand, this is not optional but is **necessary** to ensure thorough cooking. It is particularly important for dense food, such as joints of meat.

### NOTES:

- Microwaves pass through non-metallic dishes and utensils and heat the food inside the dishes.
- Microwaves are reflected by metal.
- The oven is lined with metal and has a fine metallic mesh in the door to prevent microwave leakage.
- Metallic dishes are not suitable for microwaving.
- See SUITABLE COOKWARE, page 26-27.



## HOW TO OPERATE THE OVEN

### Opening and closing the door:

- To open the oven door, press the door opening button.
- The oven lamp will light when the door is open.
- Close the door firmly and the lamp will go out.



### WARNING:

Always operate the oven with the turntable and support fitted correctly, see page 2. This promotes thorough even cooking.

- A badly fitted turntable may rattle, may not rotate properly and damage the oven.
- The turntable rotates clockwise or counter-clockwise. The rotary direction may change each time you start the oven. This does not affect cooking performance.

### MICROWAVE COOKING:

#### EXAMPLE:

To cook on HIGH (100%) power for 30 seconds.

1. Enter the heating time by pressing the **10 SEC** key three times.
  2. Press the **MICROWAVE POWER LEVEL** key once for HIGH (100%).
  3. Press the **START/AUTO MINUTE** key once to start cooking.
- Display will count down through the heating time.



x3



x1



x1

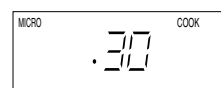

### NOTES:

- Your oven can be programmed up to 99 minutes, 90 seconds (99.90).
- When the door is opened during cooking, the cooking time on the display stops. The cooking time starts to count down again when the door is closed and the **START/AUTO MINUTE** key is pressed.
- When oven operation is finished, the time of day will reappear on the display, if set.

## MICROWAVE DEFROSTING



### MICROWAVE POWER LEVEL

To defrost foods not included in the Auto Defrost menu, use microwave power levels MEDIUM LOW (30%) or LOW (10%). Stir or turn food at least 2-3 times during defrosting. After defrosting, wrap in aluminium foil and leave to stand until thoroughly defrosted. Refer to the defrosting charts in the Cookery Book, page 32.

## CONVECTION COOKING



### CONVECTION (°C)

Your oven can be programmed to cook with ten different temperatures by combining the top and bottom grills with the convection fan.

The temperatures available in degrees Centigrade are:

**250°C, 230°C, 220°C, 200°C, 180°C,  
160°C, 130°C, 100°C, 70°C, 40°C.**

### NOTES:

- CONVECTION cooking is ideal for cooking Victoria sandwich cakes, buns, biscuits and scones. See recipes pages 54-57.
- When using the CONVECTION facility, all metal cookware can be used. See SUITABLE COOKWARE pages 26-27. To achieve the best results when cooking by CONVECTION, always use the low metal rack for one layer cooking, and the high rack and low rack for two layer cooking.
- Temperature measurements taken whilst the oven is in convection mode will differ slightly from the displayed level. This is due to the grill elements turning on and off in order to regulate the oven temperature. This will not affect the cooking results as long as the operation manual and cook book are followed properly.

### EXAMPLE:

To cook at 200°C for 20 minutes.

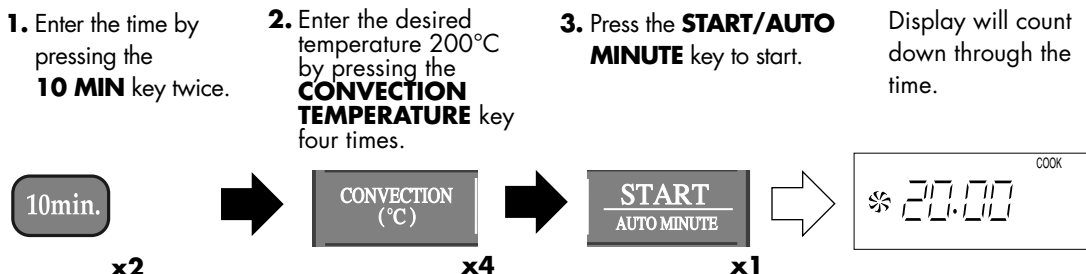

### NOTES:

- Once the oven has started you can find out the temperature you have programmed by pressing the **CONVECTION TEMPERATURE** key. The temperature will appear on the display. This will not affect the programme or cooking time.
- After cooking is complete the cooling fan will continue working for a short time to lower the temperature of the electrical and mechanical components.
- Recipes requiring a browned or crispy underside (ie; pies, pizza and bread), should be placed directly on the turntable.
- Small food items such as pastries or biscuits should be cooked on the low rack so as to avoid browning too quickly.
- Joints of meat/poultry should be cooked on the low rack with the splash guard fitted on top of the turntable.
- After cooking the display may show "NOW COOLING".

### ! WARNING:

The oven cavity, door, outer cabinet, air-vent openings, turntable, turntable support, splash guard, racks, dishes and especially bottom grill heater will become very hot, use thick oven gloves when removing the food or turntable from the oven to prevent burns.



## PREHEATING THE OVEN

CONVECTION  
(°C)

Your oven can be preheated to a desired temperature prior to oven cooking.

### EXAMPLE:

To preheat the oven to 130°C.

1. To preheat the oven, enter the desired temperature (130°C).
2. Press the **START/AUTO MINUTE** key to begin preheating.
3. When the oven reaches 130°C, the 'beep' signal will sound and the oven will display 130°C. Place food in the oven, enter the desired cooking time and temperature before pressing the **START/AUTO MINUTE** key.

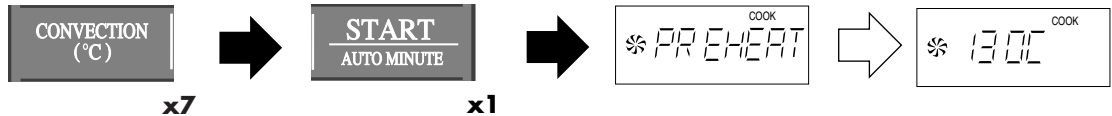

### NOTES:

- When the oven reaches the desired temperature, the 'beep' signal will sound and display the temperature in °C. **Do not press the STOP/CLEAR key**, as this will cancel the CONVECTION MODE and only MICROWAVE POWER will be in use.
- If you prefer not to preheat the oven where recommended in the Cookery Book, allow extra cooking time.
- The preheated temperature will be maintained for approximately 30 minutes before automatically turning itself off and returning to the time of day if the clock has been previously set.
- If you wish to preheat the oven then cook at a different temperature, press the **CONVECTION TEMPERATURE** key until the desired temperature is displayed.

### ! WARNING:

The oven cavity, door, outer cabinet, air-vent openings, turntable, turntable support, splash guard, racks, dishes and especially bottom grill heater will become very hot, use thick oven gloves when removing the food or turntable from the oven to prevent burns.



## GRILLING

The oven has top and bottom grills which can be operated independently or combined.

- First enter the cooking time by using the **TIME** keys.
- Then press the **GRILL** key to select the heating element(s) required (top, bottom or combined). See table opposite for selection details.
- Press the **START/AUTO MINUTE** key.

The turntable rotates to ensure even browning during grilling. Use the grill mode for bacon, fish fingers and tea cakes or for making cheese on toast. It is also ideal for browning and crisping food which has been microwaved.

Press GRILL key	Grill in use
x1 <b>Once</b>	Top Grill
x2 <b>Twice</b>	Bottom Grill
x3 <b>3 Times</b>	Top & Bottom Grill

## GRILLING (Continued)



**EXAMPLE:** To grill for 8 minutes. Using the TOP GRILL.

1. Enter the grilling time by pressing the **1MIN** key 8 times.
2. Press the **GRILL** key to select the grill mode.
3. Press the **START/AUTO MINUTE** key once to start grilling.

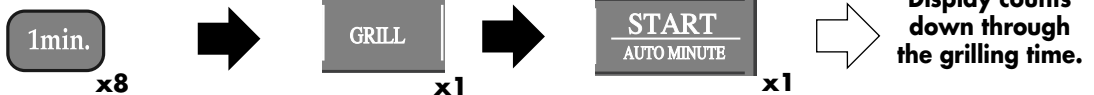

### NOTES:

- When first using the grill heating elements, smoke and odour will be given off. To avoid this happening when food is being cooked, heat the top and bottom grills without food for approximately 20 minutes.
- The high rack is recommended for grilling small items such as toast, bacon or steak. Place food directly on the rack, in a flan dish or on a heat resistant plate on the rack. Turn over halfway through grilling.
- When browning or crisping foods in a casserole dish, place directly onto the turntable or low rack.

- After cooking the display may show "NOW COOLING".

### **WARNING:**

The oven cavity, door, outer cabinet, air-vent openings, turntable, turntable support, splash guard, racks, dishes and especially bottom grill heater will become very hot, use thick oven gloves when removing the food or turntable from the oven to prevent burns.

## DUAL COOKING



### DUAL CONVECTION/GRILL

DUAL COOKING combines the power of the microwave with convection or the grills.

There are three preset DUAL COOKING modes:

1. Convection and Microwave
2. Top Grill and Microwave
3. Bottom Grill and Microwave

- First enter the cooking time.
- Then select the DUAL COOKING mode by pressing the **DUAL CONVECTION/GRILL** key until the desired setting appears on the display. See table opposite.
- Press the **START/AUTO MINUTE** key.

Press <b>DUAL CONVECTION/GRILL</b> key	<b>MICROWAVE POWER LEVEL</b>	<b>HEATER</b>
x1 Once	30%*	Convection 250°C
x2 Twice	30%*	Top Grill
x3 Three times	30%*	Bottom Grill

### **NOTE:**

- \* To adjust the microwave power level, press the **MICROWAVE POWER LEVEL** key.
- \* You can select power levels 10% to 100% for DUAL GRILL, and power levels 10% to 50% for DUAL CONVECTION.



## DUAL COOKING (Continued)

### EXAMPLE: For DUAL GRILL.

To cook using DUAL GRILL, combining MEDIUM HIGH (70%) microwave power with the top grill for 11 minutes.

1. Enter the cooking time by pressing the **10 MIN** key once and the **1 MIN** key once.
2. Press the **DUAL/CONVECTION/GRILL** key twice.
3. Press the **MICROWAVE POWER LEVEL** key three times for MEDIUM HIGH (70%).
4. Press the **START/AUTO MINUTE** key once to start cooking.

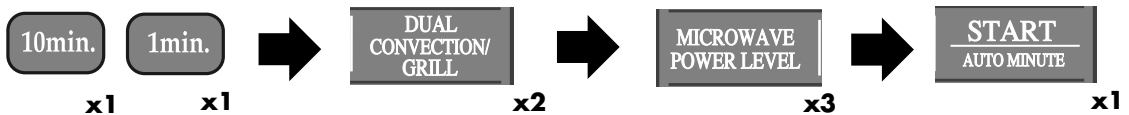

5. Halfway through cooking, open the door (or press the **STOP/CLEAR** key once, then open the door). Turn the food over.
6. Press the **START/AUTO MINUTE** key once to continue cooking.

Display counts down through cooking time.

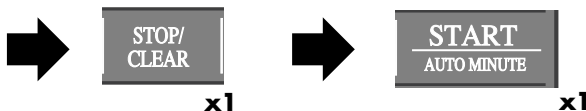

Display continues to count down through cooking time.

### COOKING HINT: For DUAL GRILL

Use the rack for grilling small items such as sausages, bacon or burgers - turn over halfway through cooking. Food can be placed directly on the rack, on a heat resistant plate or in a flan dish on the rack.

### EXAMPLE: For DUAL CONVECTION

To cook for 20 minutes on DUAL CONVECTION 230°C combined with MICROWAVE POWER LEVEL 10%

1. Enter the cooking time by pressing the **10 MIN** key twice.
2. Press the **DUAL CONVECTION/GRILL** key to select the cooking mode.
3. Press the **CONVECTION TEMPERATURE** key once to change the temperature to 230°C.



## DUAL COOKING (Continued)



4. Press the **MICROWAVE POWER LEVEL** key once to change the power to 10%.

MICROWAVE  
POWER LEVEL

x1



5. Press the **START/AUTO MINUTE** key.

START  
AUTO MINUTE

x1



The oven will count down through the cooking time.

### COOKING HINT: For DUAL CONVECTION.

In order to reduce splashes of fat inside the oven, when cooking joints of meat or poultry, use the splash guard provided. Assemble as the diagram opposite.

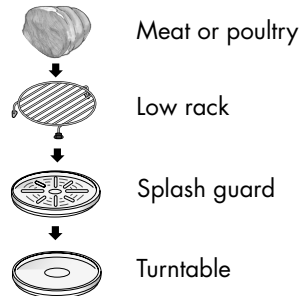

### NOTES:

- When browning or crisping foods in a casserole dish, use the low rack if the container is shallow enough. However, it is advisable to place such containers directly onto the turntable - allow a little extra time to brown and crisp.
- Follow recommended DUAL COOKING times and procedures given in the chart on pages 36-37.
- After cooking the display will show "NOW COOLING".



### WARNING:

The oven cavity, door, outer cabinet, air-vent openings, turntable, turntable support, splash guard, racks, dishes and especially bottom grill heater will become very hot, use thick oven gloves when removing the food or turntable from the oven to prevent burns.



# PIZZA



The **PIZZA** key enables you to cook chilled and frozen pizzas. The function automatically calculates the correct cooking time and mode for the pizza. (microwave power combined with the top and bottom grills).

### WEIGHT RANGE:

Food weight should be rounded up to the nearest 0.1 kg or 1 oz. For example, 0.45 kg to 0.5 kg and 12.5 oz to 13 oz. You are restricted to enter a weight within the range given in the chart below.

To cook weights below or above that range, refer to the food manufacturer's instructions.

### EXAMPLE:

Use the **PIZZA** key to cook a 0.6 kg chilled pizza.

1. Press the **PIZZA** key **once** for **CHILLED** (P-1).  
(For **FROZEN** Pizza, press twice (P-2)).
2. Enter the weight by pressing the **WEIGHT** keys until the desired weight is displayed.
3. Press the **START/AUTO MINUTE** key to start cooking. **Display counts down through the cooking time.**



x1



x6



x1

You can enter weight in Lb/oz or Kg/g. To convert to either weight range press the **WEIGHT CONVERSION** key once before entering weight.



### WARNING:

The oven cavity, door, outer cabinet, air-vent openings, turntable, turntable support, racks, dishes and especially bottom grill heater will become very hot, use thick oven gloves when removing the food or turntable from the oven to prevent burns.

**NOTE:** Press the **INFO** key for guidance in operating your oven. See pages 24-25.



# PIZZA CHART

MENU NUMBER	WEIGHT RANGE	COOKING PROCEDURE
<b>CHILLED PIZZA</b> P-1	0.1 - 0.9 kg  Thin and crispy or deep-pan type	<ul style="list-style-type: none"> <li>• Ready-prepared chilled pizza.</li> <li>• Remove from package and place on the turntable.</li> <li>• After cooking, remove from the turntable and put on a plate for serving.</li> </ul>
<b>FROZEN PIZZA</b> P-2	0.1 - 0.9 kg  Thin and crispy or deep-pan type	<ul style="list-style-type: none"> <li>• Ready-prepared frozen pizza.</li> <li>• Remove from package and place on the turntable.</li> <li>• After cooking, remove from the turntable and put on a plate for serving.</li> </ul>

- NOTES :**
- For Deep Pan frozen pizza weighing 800g and over, please press the **LESS** key after inputting the weight.
  - For converting to Lb/oz please see the conversion chart on page 40.



# BREAKFAST



The **BREAKFAST** key enables you to cook several breakfast menus. The function automatically calculates the correct cooking time and mode for the breakfast. (microwave power combined with the top and bottom grills).

### EXAMPLE:

Use the **BREAKFAST** key to cook 2 servings of Breakfast (thin sausage & eggs).

1. Press the **BREAKFAST** key **once**.
2. Enter the number of servings by pressing the **WEIGHT** keys until the desired number of servings is displayed.
3. Press the **START/AUTO MINUTE** key to start cooking. **Display counts down through the cooking time.**



x1



x2

or



x2



x1



### WARNING:

The oven cavity, door, outer cabinet, air-vent openings, turntable, turntable support, racks, dishes and especially bottom grill heater will become very hot, use thick oven gloves when removing the food or turntable from the oven to prevent burns.

**NOTE:** Press the **INFO** key for guidance in operating your oven. See pages 24-25.

# BREAKFAST CHART



WEIGHT RANGE	COOKING PROCEDURE				
1-3: servings	<ul style="list-style-type: none"> <li>• Grease the turntable with 5-10ml of oil.</li> <li>• Place bacon and/or sausages on the turntable. (Pierce sausages).</li> <li>• When oven indicates, turn bacon/sausages over and add eggs (not beaten).</li> <li>• After cooking, leave to stand for 2-3 minutes.</li> </ul> <p><b>NOTE:</b> See the table below. Use <b>MORE</b> or <b>LESS</b> as indicated.</p>				
	<b>NOTE:</b>	It is not necessary to pierce eggs as this programme uses only the grill, after the eggs have been added.			
Menu	Less/ More	Ingredient	1 Serving	2 Servings	3 Servings
Bacon & eggs	<b>LESS</b>	Bacon (approx 30g/Slice, approx 0.25cm thick) Egg (medium)	2 rashers 1	4 rashers 2	6 rashers 3
Thin sausage & eggs	<b>STD</b>	Thin sausage (approx 25g each) Egg (medium)	4 1	8 2	12 3
Bacon, thin sausage & eggs	<b>STD</b>	Bacon (approx 30g/ slice, approx 0.25cm thick) Thin sausage (approx 25g each) Egg (medium)	2 rashers 2 1	4 rashers 4 2	6 rashers 6 3
Thick sausages & eggs	<b>MORE</b>	Thick sausage (approx 50g each) Egg (Medium)	3 1	6 2	9 3



# INSTANT COOK

**INSTANT COOK** can be used for cooking the foods shown opposite.

Always refer to the Instant Cook Chart before operating this function. Press the selected key, re-press to select the correct weight and the programme will automatically start to cook after 2-3 seconds.

If food requires manipulation (i.e. turn over or stir) then open the door, when the oven indicated follow the instruction, close the door and press the **START/AUTO MINUTE** key.

**NOTES:** Your oven comes set for kg/g mode. For converting to lb/oz, press the **WEIGHT CONVERSION** key once before pressing the **INSTANT COOK** key.

**EXAMPLE:** To cook 2 baked potatoes.

Press the **BAKED POTATOES** key twice within one minute of closing the door.



x2



The oven will automatically start cooking.



## NOTES:

- The instant cook function can only be input within one minute after cooking completion, closing the door or pressing the **STOP/CLEAR** key.
- Press the **MORE** or **LESS** key before selecting the menu where recommended in the chart below.
- The final temperature will vary according to the initial food temperature. Check the food is piping hot after cooking. If necessary you can extend the cooking time and change the power.

## ! WARNING:

The oven cavity, door, outer cabinet, air-vent openings, turntable, turntable support, racks, dishes and especially bottom grill heater will become very hot, use thick oven gloves when removing the food or turntable from the oven to prevent burns.



MENU	WEIGHT RANGE	COOKING PROCEDURE																					
<b>MIXED GRILL</b>	1-2 servings	<ul style="list-style-type: none"> <li>Grease the turntable with 5-10ml of oil.</li> <li>Place chops and pierced sausages, gammon steak on the turntable and cook.</li> <li>When the audible signal sounds turn over the food, add the mushrooms and tomatoes. Close the door and continue to cook.</li> <li>After cooking, cover with foil and leave to stand for 2-3 minutes.</li> </ul> <table border="1"> <thead> <tr> <th>Mixed Grill</th> <th>1 Serving</th> <th>2 Servings</th> </tr> </thead> <tbody> <tr> <td>Gammon</td> <td>Approx. 135g</td> <td>Approx. 270g</td> </tr> <tr> <td>Chop</td> <td>Approx. 70g</td> <td>Approx. 140g</td> </tr> <tr> <td>Steak</td> <td>Approx. 100g</td> <td>Approx. 200g</td> </tr> <tr> <td>Thick sausage</td> <td>Approx. 60g</td> <td>Approx. 120g</td> </tr> <tr> <td>Mushroom</td> <td>Approx. 5 (50g)</td> <td>Approx. 10 (100g)</td> </tr> <tr> <td>Tomato</td> <td>Approx. 60g</td> <td>Approx. 120g</td> </tr> </tbody> </table>	Mixed Grill	1 Serving	2 Servings	Gammon	Approx. 135g	Approx. 270g	Chop	Approx. 70g	Approx. 140g	Steak	Approx. 100g	Approx. 200g	Thick sausage	Approx. 60g	Approx. 120g	Mushroom	Approx. 5 (50g)	Approx. 10 (100g)	Tomato	Approx. 60g	Approx. 120g
Mixed Grill	1 Serving	2 Servings																					
Gammon	Approx. 135g	Approx. 270g																					
Chop	Approx. 70g	Approx. 140g																					
Steak	Approx. 100g	Approx. 200g																					
Thick sausage	Approx. 60g	Approx. 120g																					
Mushroom	Approx. 5 (50g)	Approx. 10 (100g)																					
Tomato	Approx. 60g	Approx. 120g																					
<b>OVEN CHIPS</b>	100 g - 400 g	<ul style="list-style-type: none"> <li>Spread the frozen chips evenly on the turntable.</li> <li>After cooking, remove from the turntable.</li> </ul> <p><b>NOTE:</b> Use the <b>LESS</b> ( ▼ ) key for French fries/very thinly cut chips. Use the <b>MORE</b> ( ▲ ) key for thick type.</p>																					
<b>BAKED POTATOES</b>	1 - 4 pieces (each piece - 250 g)	<ul style="list-style-type: none"> <li>Pierce each potato in several places, place towards the edge of the turntable.</li> <li>After cooking, leave potatoes to stand for 2-3 minutes.</li> </ul>																					
<b>CAKE</b>	1 piece (0.9 - 1.0kg)	<ul style="list-style-type: none"> <li>Prepare the cake as in the recipe on pages 51 and 52.</li> <li>Place on the low rack and cook.</li> </ul> <p><b>NOTE:</b> This mode does not include Victoria Sandwich cake.</p>																					
<b>CHICKEN PORTIONS</b>	1 - 4 pieces (each piece - 250g)	<ul style="list-style-type: none"> <li>Place chicken portions best side down on the turntable.</li> <li>Stand for 4-5 minutes wrapped in aluminium foil after cooking.</li> </ul> <p><b>NOTE:</b> For safety reasons it is not possible to use <b>LESS</b> ( ▼ ) key for chicken portions</p>																					
<b>RICE/PASTA</b>	100 g - 300 g	<ul style="list-style-type: none"> <li>Add 300 ml (1/2 pint) boiling water per 100 g (4 oz) rice. Do not cover.</li> <li>Stir when oven indicates.</li> <li>Stand for 3-4 minutes before draining and rinsing in boiling water.</li> </ul>																					

## INSTANT COOK NOTES:

- If you wish to cook foods or weights of food not included in the **INSTANT COOK** facility please refer to the cooking charts in the Cookery Book.
- For converting to Lb/oz please see the converting chart on page 40.



# AUTO COOK / AUTO DEFROST

**AUTO COOK / AUTO DEFROST** enables you to cook or defrost foods listed on the menu label attached to the microwave oven and the chart on the following page. Follow the example below for details on how to operate this function.

## EXAMPLE:

1. Press the **AUTO COOK** or **AUTO DEFROST** key until the number corresponding to the food listed on the menu label appears in the display. In the example given here, the **AUTO COOK** key is pressed three times to select Roast Beef/Lamb.

2. To enter the weight in kg/g or lbs/oz, press the **WEIGHT** keys.

### WEIGHT RANGE:

Food weight should be rounded up to the nearest 0.1 kg or 1oz, for example, 0.65 kg to 0.7 kg and 12.5 oz to 13 oz. You are restricted to enter a weight within the range given (see chart on the following page).

If an incorrect weight is entered when using the **AUTO COOK/AUTO DEFROST** function, "ERROR" will be displayed.

To erase, press the **STOP/CLEAR** key.

To cook/defrost weights below or above that range, refer to the charts in the Cookery Book.

You can enter weight in Lb/oz or Kg/g. To convert to either weight range press the **WEIGHT CONVERSION** key once before entering weight.

Kg/Lb

3. Press the **START/AUTO MINUTE** key to start cooking.

### NOTES:

- Press the **MORE** or **LESS** keys before pressing the **START/AUTO MINUTE** key where recommended in the chart on the next page.
- When action is required (example to turn food over) the oven stops, the audible signals sound and any message will appear on the display. To continue cooking press the **START/AUTO MINUTE** key.
- The final temperature will vary according to the initial food temperature. Check the food is piping hot after cooking. If necessary, you can extend the cooking time and change the power level.
- Press the **INFO** key for guidance in operating your oven. See pages 24-25.

**AUTO COOK**

**AUTO DEFROST**

## EXAMPLE:

1.

**AUTO COOK** x3

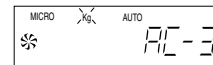

2.

Kg•Lb | g•oz



3.

**START**  
AUTO MINUTE

x1

**Display counts down through the cooking time.**



### WARNING:

The oven cavity, door, outer cabinet, air-vent openings, turntable, splash guard, turntable support, racks, dishes and especially the bottom grill will become very hot, **always use thick oven gloves** at all times when removing the food or turntable from the oven to prevent burns.



The following table shows the variety of savoury convenience foods which can be used in this microwave oven:

**Stirrable:**

Chilled or frozen ready meals which can be stirred without spoiling their appearance.  
For example: Chicken tikka, Tagliatelle and Macaroni cheese.

**Non-Stirrable:**

Chilled or frozen ready meals which cannot be stirred without spoiling their appearance.  
For example: Lasagne, Fisherman's pie, Cottage pie.

**In-One-Bag:**

Frozen ready meals contained and cooked in one bag.  
For example: Chicken breast and gravy, Beef curry, Liver with onions and gravy.

**In-Two-Bags:**

Frozen ready meals contained and cooked in two bags.  
For example: Prawn curry with rice, Spaghetti bolognese and Chicken chasseur with Rice.

## AUTO COOK CHART

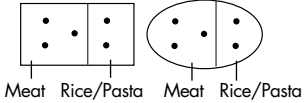
MENU NUMBER	COOKING PROCEDURE CHILLED/FROZEN READY MEALS
<p><b>AC - 1</b> <b>CHILLED READY MEALS</b> (5°C) 300 g - 800 g</p> <p><b>AUTO COOK</b></p> <p><b>x1</b></p>	<ul style="list-style-type: none"> <li>For one section containers, use a skewer to pierce film in five places.</li> </ul>  <ul style="list-style-type: none"> <li>For two section containers, pierce using a skewer. Pierce meat/main portion 3 times and the rice/pasta portion twice.</li> </ul> 
<p><b>AC - 2</b> <b>FROZEN READY MEALS</b> (-18°C) 300g - 800g</p> <p><b>AUTO COOK</b></p> <p><b>x2</b></p>	<ul style="list-style-type: none"> <li>For food contained in bag(s), pierce meat portion 5 times on each side. For rice/pasta pierce 5 times on one side only (where rice/pasta portion bags come already perforated, do not pierce further).</li> <li>Place on a plate on the low rack.</li> <li>Close the oven door, press the <b>AUTO COOK</b> key once for chilled or twice for frozen ready meals.</li> <li>To enter the weight, press the <b>WEIGHT</b> keys.</li> <li>Press the <b>START/AUTO MINUTE</b> key to start cooking.</li> </ul> <p><b>(NOTE: For non-stirrable foods, press the MORE key, before pressing the START/AUTO MINUTE key.)</b></p> <ul style="list-style-type: none"> <li>After cooking, leave to stand for 2-3 minutes before serving.</li> </ul>
	<p><b>NOTES:</b></p> <ul style="list-style-type: none"> <li>For stirrable foods, stir as oven indicates. For food in bags, manipulate contents. For non-stirrable foods, it is not necessary to stir.</li> <li>For frozen meals contained in two bags remove the rice/pasta portion when the oven indicates "STIR" halfway through cooking.</li> <li>It is not possible to use <b>LESS</b> for these menus.</li> </ul>



# AUTO COOK / AUTO DEFROST CHART

## AUTO COOK CHART

MENU NUMBER	WEIGHT RANGE	COOKING PROCEDURE
<b>AC - 3</b> Roast Beef / Lamb	0.6 - 1.8 kg	<ul style="list-style-type: none"> <li>Place the splash guard into the turntable.</li> <li>Place meat directly on the low rack.</li> <li>After cooking, wrap in foil and leave meat to stand for 10 minutes.</li> </ul>
<b>AC - 4</b> Roast Pork	0.6 - 1.8 kg	<p><b>NOTE:</b> Use <b>MORE</b> for beef/lamb which is well done and <b>LESS</b> (for beef only) for meat which is rare. It is not possible to use <b>LESS</b> for pork.</p>
<b>AC - 5</b> Roast Poultry	1.2 - 1.8 kg	<ul style="list-style-type: none"> <li>Place the splash guard into the turntable.</li> <li>Pierce skin of poultry.</li> <li>Place poultry breast side up directly on the low rack.</li> <li>After cooking, wrap in foil and leave meat to stand for 10 minutes.</li> </ul> <p><b>NOTE:</b> It is not possible to use <b>LESS</b> for poultry.</p>

## AUTO DEFROST CHART

MENU NUMBER	WEIGHT RANGE	COOKING PROCEDURE
<b>AD - 1</b> Meat (Beef/Lamb and Pork Joints)	0.6 - 1.8 kg	<ul style="list-style-type: none"> <li>Place meat in a flan dish on the turntable.</li> <li>Turn over when oven indicates.</li> <li>Stand, wrapped in foil, for 45-60 minutes until thoroughly defrosted.</li> </ul>
<b>AD - 2</b> Poultry (Whole)	1.2 - 1.8 kg	<ul style="list-style-type: none"> <li>Place poultry breast side down in a flan dish, place on the turntable.</li> <li>Turn over when oven indicates.</li> <li>Stand wrapped in foil for 45-60 minutes until thoroughly defrosted.</li> </ul>
<b>AD - 3</b> Chicken Portions, Steak, Chops	0.2 - 1.0 kg	<ul style="list-style-type: none"> <li>Place meat evenly in a flan dish on the turntable.</li> <li>Turn over when oven indicates.</li> <li>Leave meat to stand in foil, for 15-30 minutes until thoroughly defrosted.</li> </ul>
<b>AD - 4</b> Minced Meat (Beef, Lamb, Pork, Poultry)	0.2 - 1.0 kg	<ul style="list-style-type: none"> <li>Place in a glass bowl on the turntable.</li> <li>When oven indicates turn over. Remove any defrosted parts.</li> <li>Leave meat to stand wrapped in foil, for 5-10 minutes until evenly defrosted.</li> </ul>
<b>AD - 5</b> Bread	0.1 - 0.8 kg	<ul style="list-style-type: none"> <li>Place directly on the turntable.</li> <li>Turn over when oven indicates.</li> <li>Leave bread to stand for up to 5 minutes until defrosted.</li> </ul>

For converting to lb/oz please see the conversion chart on page 40.

**DEFROST:** When defrosting, small pieces of aluminium foil can be used to shield small areas of the meat if they become warm. Ensure that the foil does not touch the oven walls. Do not cook meat until it is thoroughly defrosted.

## OTHER CONVENIENT FUNCTIONS



### 1. MULTIPLE SEQUENCE COOKING:

A sequence of 4 stages (maximum) can be programmed using combinations of **MICROWAVE**, **CONVECTION**, **GRILL** or **DUAL COOKING**.

- To programme a series of sequences: Input the cooking time followed by the desired cooking mode.
- Repeat this procedure three times, to a maximum of four sequences.
- Finally, press the **START/AUTO MINUTE** key to start sequence cooking.

#### Example:

If you want to cook for 5 minutes on 100% microwave power and then for 16 minutes on 30% power.

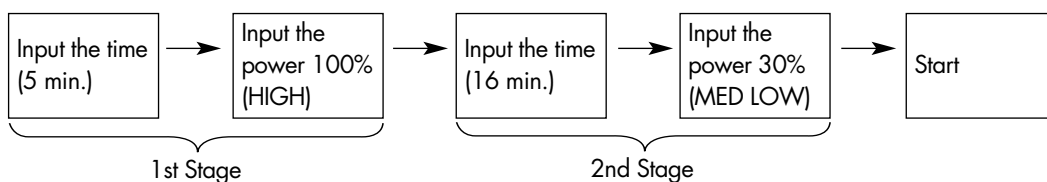

### 2. TIMER:

You can use the **TIMER** for timing where microwave cooking is not involved. For example, to time boiled eggs cooked on a conventional hob, to monitor the standing time for microwaved food or to remind you of the time when making a phone call.

**Example:** To set the timer for 5 minutes to boil an egg on a conventional hob.

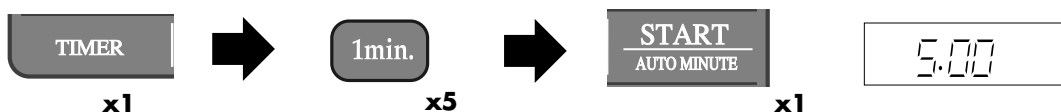

1. Press the **TIMER** key once.
2. Press the **1 MINUTE** key 5 times.
3. When the water comes to the boil, add the egg, and press the **START/AUTO MINUTE** key once.
4. The display will count down. When the display reaches zero, the 'beep' signal will sound.

You can enter any time up to 99 minutes, 90 seconds. To cancel the **TIMER** whilst counting down, simply press **STOP/CLEAR** and the display will return to the time of day, if set.

### 3. TO CHECK THE POWER LEVEL

To check the microwave power level during cooking press the **MICROWAVE POWER LEVEL** key. As long as your finger is touching the **MICROWAVE POWER LEVEL** key the power level will be displayed. The oven continues to count down although the display will show the power level.



## OTHER CONVENIENT FUNCTIONS

### 4. AUTO START

**AUTO START** enables you to programme the oven manually to come on during the next 12 hours.

**AUTO START  
CLOCK**

**IMPORTANT:** It is recommended that the oven is always attended when in use. Check to ensure you have programmed the oven correctly. Exceeding cooking times and use of excessive power can lead to food overheating and cause a risk of fire.

- You can use **AUTO START** only with manual cooking.
- Before programming the oven, always check the display is showing the correct time of day.
- Once programmed the display will return to show the time of day.  
To check the **AUTO START** time press and hold the **AUTO START/CLOCK** key.
- The **AUTO START** time can only be entered in multiples of 10 minutes. It is not possible to enter less than 10 minutes or any time which is not in multiples of 10 minutes.
- If the door is opened after programming, close the door and press the **START/AUTO MINUTE** key to continue with **AUTO START**.

#### AUTO START EXAMPLE

To reheat a casserole on MEDIUM (50%) for 20 minutes at 4:00 pm.



1. Enter the time you want cooking to start, then press the **AUTO START/CLOCK** key once.

2. Press the **10 MIN** key twice to enter the desired cooking time. (20 mins.)

#### Display will show

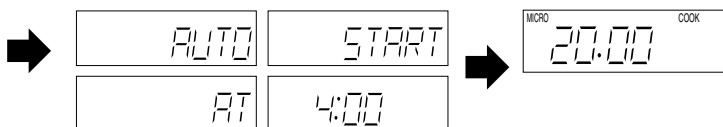
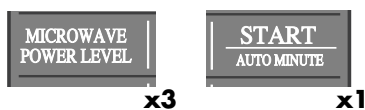

3. Set the power level, then press the **START/ AUTO MINUTE** key.

and then the display will return to show the time of day.

4. Oven will start pre-programmed cooking at set time.

**NOTE:** This function will only work if the clock has previously been set.

The oven cannot be used once the **AUTO START** has been programmed. To cancel the program, press **STOP/CLEAR** twice.

### 5. AUTO MINUTE

**AUTO MINUTE** enables you:

- To cook directly on 100% (HIGH) microwave power in multiples of 1 minute,
- Extend cooking time in multiples of 1 minute.

#### EXAMPLE:

To cook on 100% (HIGH) for 2 minutes, press the **START/AUTO MINUTE** key twice.

**NOTE:** The **AUTO MINUTE** function for direct start, can only be input within 1 minute after cooking completion, closing the door or pressing the **STOP/CLEAR** key. The cooking time can be extended to a maximum of 99 minutes.



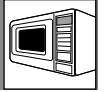

## 6. LESS AND MORE

The **LESS** (▼) and **MORE** (▲) keys allow you to cook food more or less time than the pre-set programmes.

For example, if you prefer vegetables which are cooked but still crisp, or beef which is rare, use the **LESS** key. Alternatively, if you prefer vegetables softer or beef well done, use the **MORE** key.

### GUIDE FOR USE WITH PIZZA/BREAKFAST/INSTANT COOK/AUTO COOK/AUTO DEFROST.

- **INSTANT COOK:** Press the **LESS/MORE** key before pressing the **INSTANT COOK** key.
- **PIZZA/BREAKFAST/AUTO COOK/AUTO DEFROST:** Press the **LESS/MORE** key immediately before pressing the **START/AUTO MINUTE** key.

**NOTE:** To cancel **LESS** or **MORE**, press the same key again.

### GUIDE FOR USE MANUALLY:

To alter cooking or defrosting time whilst the oven is in operation, use the **LESS** or **MORE** key. Press the **LESS/MORE** keys to decrease/increase the cooking or defrosting time in multiples of 1 minute.

- The overall cooking time can be increased to a maximum of 99 minutes.

### NOTE:

It is also possible to increase time during cooking by pressing the **START/AUTO MINUTE** key. This increases cooking time by 1 minute with each press.

### EXAMPLE:

To cook on MEDIUM (50%) for 10 minutes and then decrease the cooking time by 2 minutes.

1. Enter the cooking time by pressing the **10 MIN.** key once.
2. Press **MICROWAVE POWER LEVEL** key 3 times for MEDIUM (50%).
3. Press **START/AUTO MINUTE** once to start cooking.



x1



x3



x1



### Display counts down.

The time can be extended or shortened at any stage during the 10 minutes.



4. Press **LESS** twice to shorten the cooking time by 2 minutes.



x2



Cooking time is reduced by two minutes and continues to count down.



LESS COOKING TIME



MORE COOKING TIME



# OTHER CONVENIENT FUNCTIONS

## 7. INTERACTIVE DISPLAY



The **INFO** key provides a step-by-step interactive guide which illuminates the display.

When you plug the oven in, the auto setting for the interactive display is on.

This will assist you to determine:

- The next action on the way to completing any programme (manual or automatic).
- Weight ranges for automatic programmes
- Action required during or after cooking, eg when to stir or turn food, whether to leave the food to stand at the end of cooking.

The INFO key also provides information for the BREAKFAST, PIZZA and AUTO COOK/DEFROST programmes. To activate the guide press the **INFO** key whenever **INFO** is lit in the display.

As you become familiar with the oven, the interactive guide can be turned OFF. (See page 25.)

**EXAMPLE 1:** To get a cooking hint for Pizza, Breakfast, Auto Cook or Auto Defrost.

To cook 0.6kg Roast Pork using the AUTO COOK programme. Place splash guard in turntable. Place pork on the low rack. Close the door.

1. Press **AUTO COOK** key four times.

- The display will flash a series of messages. The display confirms you have selected AC-4; the AUTO COOK programme for roast pork. The weight range of 0.6kg - 1.8kg will appear in the display. You will be prompted to enter the weight.

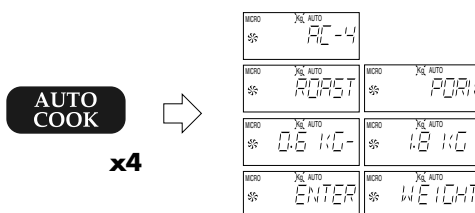

2. Enter the weight by pressing the **g•oz** key six times (0.6kg). INFO will appear in the display.

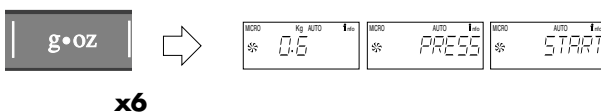

3. Press the **INFO** key once to obtain cooking guidance if required.

- The display will show a series of messages.

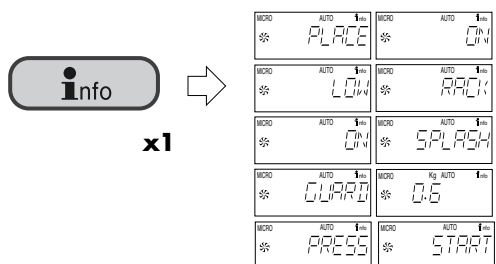

4. Press the **START/AUTO MINUTE** key to start cooking.

- The display will count down through the cooking sequence.



x1

# OTHER CONVENIENT FUNCTIONS



**EXAMPLE 2:** You can obtain guidance for each key by using the **INFO** key.

To obtain the guidance for using the **WEIGHT CONVERSION** key.

1. Press the **INFO** key once to make sure the interactive display appears in the display.
2. Press the **WEIGHT CONVERSION** key once.
  - This key is for selection of kg/g or lb/oz as desired.

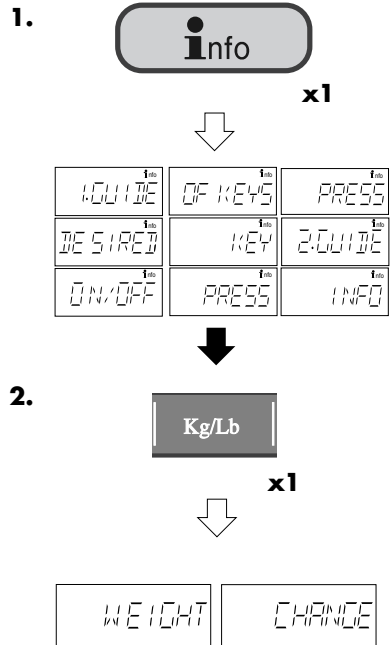

**EXAMPLE 3:** To switch the interactive display ON/OFF.

1. Press the **INFO** key twice.
2. Press the **STOP/CLEAR** key once to turn the interactive guide OFF.
 

GUIDE OFF will appear in the display and then the display will show the time of day.

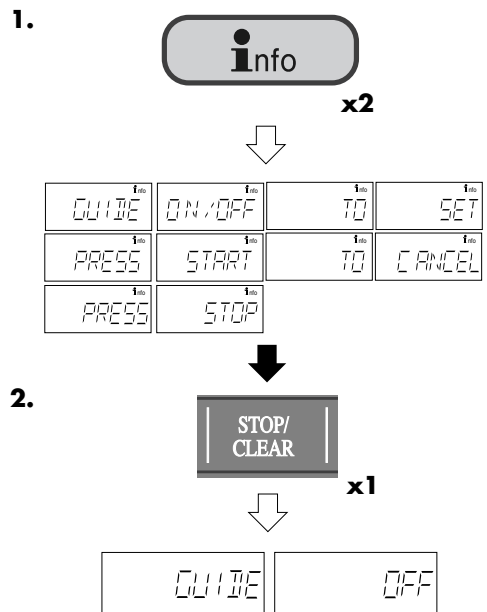

**NOTES:**

If you want to restore the interactive guide, press the **START/AUTO MINUTE** key at step 2 above.

- GUIDE ON will appear in the display and then the display will show the time of day.



## SUITABLE COOKWARE



### **WARNING - Always attend the oven when in use.**

**Carefully follow the SHARP Operation Manual at all times. If you exceed recommended cooking times and/or use power levels that are too high, food may overheat, burn, and in extreme circumstances, catch fire and damage the oven.**





- The microwave power level will default to HIGH (100%) unless you press the **MICROWAVE POWER LEVEL** key to reach the desired setting. Take care when heating foods with high sugar or fat content, e.g, Christmas pudding, mince pies and fruit cakes. Before use, check that utensils are suitable for use in microwave ovens.

### **WARNING - Liquids and other foods must not be heated in sealed containers since they are liable to explode.**

- **Lids:** Always remove lids from food jars and containers before using them in the oven. If you do not, steam and pressure will build up inside and the container may explode. Take care when heating contents in babies bottles, see page 27.
- Eggs in their shell and whole hard boiled eggs should not be heated in microwave ovens since they may explode even after microwave heating has ended. Do not heat canned potatoes in the microwave oven as they may burst.
- Do not place hot foods/utensils on a cold turntable, or cold foods/utensils on a hot turntable.

### **For microwaving, use only those utensils suitable for microwave cookery as indicated below.**

A variety of cookware can be used for microwaving. Round/oval dishes rather than square/oblong ones are recommended, as food in the corners tends to overcook.

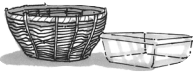
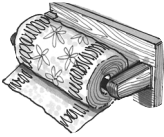
COOKWARE	SUITABLE FOR MICROWAVING	GRILL	CONVECTION	DUAL COOKING	
Heat resistant glass, (e.g. Pyrex®, Fire King®, Corning Ware®).	<b>YES</b>	<b>YES</b>	<b>YES</b>	<b>YES</b>	
Microwave-safe plastic cookware.	<b>YES</b>	<b>NO</b>	<b>NO</b>	<b>NO</b>	
Microwave cling film, microwave roasting bags.	<b>YES</b> Microwave cling film and bags must be vented for steam to escape, pierce in 4-5 places. Do not use plastic or metal ties as they may melt or catch fire due to 'arcing'.	<b>NO</b>	<b>NO</b>	<b>NO</b>	
Heat-resistant china and ceramics.	<b>YES</b> Except for dishes with metallic decoration.	<b>NO</b>	<b>YES</b>	<b>YES</b> Except for dishes with metallic decoration.	
Disposable containers: Thin plastic, paper, straw and wooden containers.	<b>YES</b> Always attend the oven closely. Look at the oven from time to time when cooking or reheating food in disposable containers of plastic, paper or other combustible material. Only use for warming food. Pay special attention as over-heating may cause a fire in your oven.	<b>NO</b>	<b>NO</b>	<b>NO</b>	
Kitchen paper.	<b>YES</b> Always attend the oven closely. Only use to absorb fat and moisture when warming food. Pay special attention as over-heating may cause a fire in your oven.	<b>NO</b>	<b>NO</b>	<b>NO</b>	

# SUITABLE COOKWARE (Continued)



COOKWARE	SUITABLE FOR MICROWAVING	GRILL	CONVECTION	DUAL COOKING	
Browning dishes & self-heating packages.	<b>YES</b> Always place on an up-turned plate on the turntable to prevent heat stress. Follow manufacturer's instructions. Be careful as these become very hot. <b>Popcorn:</b> Only use microwave popcorn within recommended packaging (follow popcorn manufacturer's instructions). Never use oil unless the manufacturer recommends and never cook for longer than instructed.	<b>NO</b>	<b>YES</b>	<b>NO</b>	
Metal cookware.	<b>NO</b>	<b>YES</b> If desired, metal trays may be used.	<b>YES</b> Use for combination cooking or convection only.	<b>YES</b>	
Aluminium foil & foil containers, made from "Micro Foil®".	<b>YES/NO</b> Use small pieces of aluminium foil to shield food from overheating. Keep foil at least 2cm from the oven walls. Foil containers are not recommended unless specified by the manufacturer, eg. MicroFoil®, follow instructions carefully.	<b>YES</b>	<b>YES</b>	<b>YES/NO</b> Use aluminium foil for shielding only.	
Metal racks	<b>YES</b> The metal racks supplied have been specially designed for all cooking modes and will not damage the oven.	<b>YES</b>	<b>YES</b>	<b>YES</b>	
Splash Guard	<b>NO</b>	<b>YES</b>	<b>YES</b>	<b>YES</b> Where recommended page 13.	

# FOOD HANDLING & PREPARATION



**Face & Hands:** Always use oven gloves to remove food or cookware from the oven. Stand back when opening the oven door to allow heat or steam to disperse. When removing covers (such as cling-film), opening roasting bags or popcorn packaging, direct steam away from face and hands.



**Check the temperature of food and drink and stir (before serving). Take special care when serving babies, children or the elderly. The contents of feeding bottles and baby food jars should be stirred or shaken and the temperature checked before consumption to avoid burns.**

## Stir, turn & stand:

For even cooking stir, turn or rearrange food during cooking. Where recommended, leave food to stand after cooking or defrosting.

## Initial and final temperature of food:

The initial temperature of food affects the amount of cooking time needed, eg. chilled food requires more cooking than food at room temperature. The temperature of the container is not a true indication of the temperature of the food or drink. Cut into foods with fillings, for example, jam doughnuts, to release heat or steam.



# FOOD HANDLING & PREPARATION (Continued)

## Composition & quality

Food high in fat or sugar (Christmas pudding, mince pies) requires less heating time and should be watched, over-heating can lead to fire. Use good quality ingredients for microwaving. Economical cuts of meat can be used for casseroles.



## Piercing

**Food with skin (e.g. potatoes, apples, fish, sausages, chicken), or with membrane (e.g. egg whites/yolks), must be pierced in several places before cooking or reheating. If not, steam will build up and may cause food to explode. When cooking eggs using the "Breakfast" key, it is not necessary to pierce the yolks, as the programme uses grill only.**



## Arrangement

Place thickest parts of food on the outside of the dish, e.g. place meaty ends of chicken drumsticks on the outside of the dish.

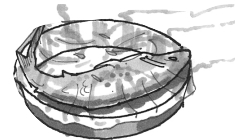

## Covering

Fish, vegetables and certain other foods benefit from being covered during microwave cookery, follow recommendations where given and use vented microwave cling-film or a suitable lid.



## Size & shape

Food size and shape affects the amount of cooking time needed. When cooking more than one portion of the same food ensure they are of a similar size and shape.



## Density & quantity

Food density and quantity affect the amount of cooking time needed, for example, potatoes require more cooking than peas; four potatoes will take longer to cook than two.

## Hygiene

Food hygiene standards (storage, handling and preparation) apply to microwaving. Always store convenience foods as recommended by the food manufacturer and keep no longer than the "Use By" date.

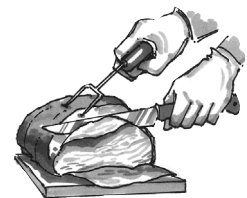



## Meat joints

Place in a flan dish, turn over at least 4-5 times during defrosting, shield any warm areas with small, flat pieces of foil. After defrosting, wrap in foil and allow meat to stand for 60-90 minutes, until thoroughly defrosted.



## Poultry

Place in a flan dish, turn over at least 3-4 times during defrosting, shield any warm areas with small, pieces of foil. After defrosting, wrap in foil and allow poultry to stand for 60-90 minutes, until thoroughly defrosted.

**NOTE:** Do not defrost poultry with giblets.



## Steak, Chops & Chicken Portions

Place in a flan dish, separate during defrosting and turn over at least 2-3 times. Shield if necessary.



## Cubed & Minced Meat

Place in a bowl, stir or turn over at least 3-4 times during defrosting, remove defrosted parts each time. For frozen blocks of meat see 'Minced Beef' in the charts on page 32.



## Whole Fish & Fillets

Place in a flan dish, separate during defrosting and turn over at least twice. Shield if necessary.



## Prepacked Frozen Foods

Remove packaging, including any foil and place in a suitable dish.



### NOTES:

- To defrost food, use either MEDIUM LOW/DEFROST (30%) or LOW (10%) microwave power.
- Shield warm areas with small pieces of foil if necessary.
- It is important to turn food over, separate (where appropriate) and rearrange to ensure even defrosting.
- Standing time is necessary to ensure thorough defrosting.



## ADVICE FOR REHEATING



### WARNINGS:

**Oil & Fat:** Never heat oil or fat for deep frying as this may lead to overheating and fire. Stand back when opening the oven door to allow heat or steam to disperse. When removing covers (such as cling-film), opening roasting bags or popcorn packaging, direct steam away from face and hands.

**Microwave heating of beverages can result in delayed eruptive boiling, therefore care has to be taken when handling the container.**

- Remove food from foil or metal containers before reheating.
- Reheating times will be affected by the shape, depth, quantity and temperature of food together with the size, shape and material of the container.
- To avoid overheating and fire, special care must be taken when reheating foods with a high sugar or fat content, for example, mince pies, Christmas pudding.
- Canned potatoes should not be heated in the microwave oven, follow the manufacturers' instructions on the can

### Plated meals

**Remove any poultry or meat portions, reheat these separately, see below.** Place smaller items of food to the centre of the plate, larger and thicker foods to the edge. Cover with vented microwave cling-film and reheat on MEDIUM (50%), stir/rearrange halfway through reheating. Ensure food is thoroughly reheated before serving.

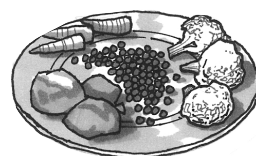

### Casseroles

Cover with vented microwave cling-film or suitable lid, reheat on MEDIUM (50%). Stir frequently to ensure even reheating.



### Poultry portions

Place thickest parts of the portions on the outside of the dish, cover with microwave cling-film and reheat on MEDIUM HIGH (70%). Turn over halfway through. **NOTE:** Ensure poultry is thoroughly reheated, before serving.

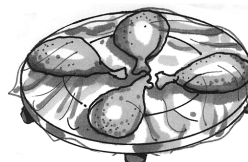

### Sliced meat

Cover with vented microwave cling-film and reheat on MEDIUM (50%). Rearrange at least once to ensure even reheating. **NOTE:** Ensure meat is thoroughly reheated before serving.



### Pies

Place pies in a flan dish. Reheat meat pies on MEDIUM HIGH (70%) and fruit pies on MEDIUM (50%).



### Vegetables

Cover with vented microwave cling-film or suitable lid and reheat on MEDIUM (50%). Stir at least once during reheating.





# INTRODUCTION

This Cookery Book contains a wide variety of recipes developed specifically for your microwave oven. These will give you successful results and will save time and electricity. The recipes demonstrate the capabilities of your oven and prove that microwave technology combined with a unique upper and lower heating system is the efficient and effective alternative to conventional cooking.

## CONTENTS

### Charts:

Defrosting .....	33
Microwave .....	34-36
Grilling .....	36
Dual Grill .....	37-38
Top & Bottom Grill .....	38-39
Convection .....	40
Microwave Reheating .....	40
Conversion Charts .....	40

### Recipes:

Starters .....	41-42
Fish .....	43

Meat .....	44-45
Poultry .....	46-47
Vegetarian .....	48
Cheese & Eggs .....	49
Rice & Pasta .....	50
Vegetables .....	51
Desserts .....	52-53
Sweets .....	53
Cakes & Biscuits .....	54-55
Bread & Scones .....	56-57
Sauces .....	58-59
Preserves .....	59

### IMPORTANT COOKERY NOTES:

- 1 Food temperatures are:-  
Frozen: -18°C, Chilled: 5°C, Room: 20°C
- 2 When cooking Rice & Pasta (see page 51), cooking time is constant for any quantity of rice or pasta; boiling water must be adjusted according to quantity of rice or pasta. After leaving the Rice/Pasta to stand, rinse in boiling water prior to serving.
- 3 Refer to operation manual for advice on suitable cookware.
- 4 Where dishes are covered, use vented microwave cling film unless otherwise stated. Where dishes are lined, use greaseproof paper unless otherwise stated.
- 5 For sequence programming refer to the operation manual (page 21).

#### SYMBOLS:

- **Method:** Where shielding is necessary use small pieces of foil.
- **Poultry Chart:** Chicken, turkey and duck must be defrosted without giblets.
- ▲ **Standing Time:** During recommended standing time, wrap or cover food in foil.

## DEFROSTING (MICROWAVE)

FOOD	DEFROST TIME	MICRO POWER LEVEL	METHOD	STANDING TIME
<b>Meat Joints (Beef, Lamb, Pork)</b>	30-32 Minutes 450g (1lb)	LOW	• Place in a flan dish Turn over 4-5 times during defrosting. Shield.	• 45-60 Minutes
<b>Minced Beef</b>	8-9 Minutes 450g (1lb)	MEDIUM LOW	• Place on a plate or in a bowl. Turn over/ stir 3-4 times, removing defrosted mince each time.	• 15-20 Minutes
<b>Steak 2cm (3/4") thick</b>	11-12 Minutes 450g (1lb)	MEDIUM LOW	• Place in a flan dish. Turn over 2-3 times, separate during defrosting. Shield.	• 25-30 Minutes
<b>Chops &amp; Sausages</b>	16-18 Minutes 450g (1lb)	MEDIUM LOW	• Place in a flan dish. Turn over 2-3 times, separate during defrosting. Shield.	• 25-30 Minutes
<b>Bacon</b>	11-12 Minutes 450g (1lb)	MEDIUM LOW	• Place on a plate. Separate and rearrange twice during defrosting. Shield.	• 5-10 Minutes
<b>•Whole poultry (Chicken, Turkey, Duck)</b>	20-22 Minutes 450g (1lb)	LOW	• Place in a flan dish. Turn over 4-5 times during defrosting. Shield.	• 45-60 Minutes
<b>•Chicken Portions</b>	8-9 Minutes 450g (1lb)	MEDIUM LOW	• Place in a flan dish. Turn over, rearrange 2-3 times during defrosting. Shield.	• 25-30 Minutes
<b>•Chicken/Turkey Breast &amp; Drumsticks</b>	11-12 Minutes 450g (1lb)	MEDIUM LOW	• Place in a flan dish. Turn over, rearrange 2-3 times during defrosting. Shield.	• 25-30 Minutes
<b>•Minced Turkey</b>	11-12 Minutes 450g (1lb)	MEDIUM LOW	• Place on plate or in a bowl. Turn over/ stir 3-4 times removing defrosted mince each time.	• 15-20 Minutes
<b>Whole Fish (Trout, Mackerel)</b>	9 Minutes 450g (1lb)	MEDIUM LOW	• Place in a flan dish. Turn over twice during defrosting. Shield.	• 15 Minutes
<b>Fish Fillets/ Steaks</b>	7-8 Minutes 450g (1lb)	MEDIUM LOW	• Place in a flan dish. Turn over twice, separate during defrosting. Shield.	• 15 Minutes
<b>Apples</b>	8-9 Minutes 450g (1lb)	MEDIUM LOW	• Place in a dish. Stir during defrosting.	10 Minutes
<b>Blackcurrants/ Redcurrants Raspberries/ Blackberries</b>	6-7 Minutes 450g (1lb)	MEDIUM LOW	• Place in a dish. Stir during defrosting.	10 Minutes
<b>Gooseberries Rhubarb/ Strawberries</b>	7-8 Minutes 450g (1lb)	MEDIUM LOW	• Place in a dish. Stir during defrosting.	10 Minutes
<b>Bread (sliced)</b>	6 Minutes 400g (14oz)	MEDIUM LOW	• Place on the turntable. Separate and rearrange during defrosting.	5-10 Minutes
<b>Pastry (Puff or Shortcrust)</b>	5 Minutes 450g (1lb)	MEDIUM LOW	• Place on a plate. Turn over halfway through defrosting.	10-15 Minutes
<b>Meat &amp; Fruit Pies (cooked)</b>	7-8 Minutes large pie	MEDIUM LOW	• Remove from foil container. • Place in a shallow flan dish.	15-20 Minutes

**Note:** Ensure you read all cookery notes on page 31, for advice and explanations of symbols before proceeding.

# MICROWAVE / COOKING

FOOD	COOKING TIME	MICRO POWER LEVEL	METHOD	STANDING TIME*
<b>Beef (rare) (Topside, Silverside)</b>	10-11 Minutes 450g (1lb)	MEDIUM HIGH	• Place in a flan dish. Turn over halfway through cooking.	▲ 6 Minutes
<b>Beef (medium) (Topside, Silverside)</b>	13-14 Minutes 450g (1lb)	MEDIUM HIGH	• Place in a flan dish. Turn over halfway through cooking.	▲ 8 Minutes
<b>Beef (well done) (Topside, Silverside)</b>	17-18 Minutes 450g (1lb)	MEDIUM HIGH	• Place in a flan dish. Turn over halfway through cooking.	▲ 10 Minutes
<b>Beefburgers</b>	10-11 Minutes 450g (1lb)	MEDIUM HIGH	• Place in a flan dish. Turn over halfway through cooking.	▲ 2-3 Minutes
<b>Minced Meat</b>	8-9 Minutes 450g (1lb)	MEDIUM HIGH	• Place in a bowl. Stir 2-3 times during cooking.	▲ 2-3 Minutes
<b>Sausages (thick)</b>	4-5 Minutes 4 sausages	HIGH	• Place in a flan dish. Turn over halfway through cooking.	▲ 2 Minutes
	6-7 Minutes 8 sausages	HIGH	• Place in a flan dish. Turn over halfway through cooking.	▲ 2 Minutes
<b>Sausages (thin)</b>	2 Minutes 4 sausages	HIGH	• Place in a flan dish. Turn over halfway through cooking.	▲ 2 Minutes
<b>Lamb (Fillet, Shoulder, Leg)</b>	17-18 Minutes 450g (1lb)	MEDIUM HIGH	• Place in a flan dish. Turn over halfway through cooking.	▲ 10 Minutes
<b>Lamb Chops</b>	10-11 Minutes 450g (1lb)	MEDIUM HIGH	• Place in a flan dish. Turn over halfway through cooking.	▲ 5 Minutes
<b>Pork (Loin, Leg)</b>	19-20 Minutes 450g (1lb)	MEDIUM HIGH	• Place in a flan dish. Turn over halfway through cooking.	▲ 10 Minutes
<b>Pork Chops (with bone)</b>	17-18 Minutes 450g (1lb)	MEDIUM HIGH	• Place in a flan dish. Turn over halfway through cooking.	▲ 4-5 Minutes
<b>Pork Chops (boneless)</b>	13-14 Minutes 450g (1lb)	MEDIUM HIGH	• Place in a flan dish. Turn over halfway through cooking.	▲ 4-5 Minutes
<b>Gammon Joint</b>	19-20 Minutes 450g (1lb)	MEDIUM HIGH	• Place in a flan dish. Turn over 4 times during cooking.	▲ 10 Minutes
<b>Bacon</b>	3 Minutes 4 rashers	HIGH	• Place on a plate. Turn over halfway through cooking.	▲ 1 Minutes
<b>Whole Poultry Chicken, Turkey, &amp; Duck</b>	10-11 Minutes 450g (1lb)	HIGH	• Place in a flan dish. Turn over halfway through cooking.	▲ 10 Minutes
<b>Chicken Portions Chicken/Turkey Breasts &amp; Drumsticks</b>	10-11 Minutes 450g (1lb)	HIGH	• Place in a flan dish. Turn over halfway through cooking.	▲ 5 Minutes
<b>Minced Turkey</b>	8-9 Minutes 450g (1lb)	HIGH	• Place in a bowl. Stir 2-3 times during cooking.	▲ 5 Minutes
<b>Fish Fillets</b>	7 Minutes 450g (1lb)	HIGH	• Place in a single layer in a flan dish. Cover and cook.	▲ 2-3 Minutes
<b>Whole Fish &amp; Steaks</b>	7-8 Minutes 450g (1lb)	HIGH	• Place in a single layer in a flan dish. Cover and cook.	▲ 2-3 Minutes

**Note:** Ensure you read all cookery notes on page 31, for advice and explanations of symbols before proceeding.

# MICROWAVE COOKING

FOOD	COOKING TIME	MICRO POWER LEVEL	METHOD	STANDING TIME
<b>Aubergines &amp; Broccoli (fresh)</b>	5 Minutes 225g (8oz)	HIGH	• Slice. Add 30ml (2tbsp) water. Cover dish. Stir halfway through cooking.	2 Minutes
<b>Beans (Fresh green)</b>	5-6 Minutes 225g (8oz)	HIGH	• Add 30ml (2tbsp) water. Cover dish. Stir halfway through cooking.	2 Minutes
<b>Brussels Sprouts (fresh)</b>	5-6 Minutes 225g (8oz)	HIGH	• Add 45ml (3tbsp) water. Cover dish. Stir halfway through cooking.	2 Minutes
<b>Cabbage, Carrots, Cauliflower &amp; Celery (fresh)</b>	5 Minutes 225g (8oz)	HIGH	• Slice or break into florets. Add 30ml (2tbsp) of water. Cover dish. Stir halfway through cooking.	2 Minutes
<b>Corn on the Cob (fresh)</b>	6-7 Minutes 2 cobs	HIGH	• Add 45ml (3tbsp) water. Cover dish. Turn over halfway through cooking.	2 Minutes
<b>Courgettes &amp; Leeks (fresh)</b>	4-5 Minutes 225g (8oz)	HIGH	• Slice. Add 30ml (2tbsp) water. Cover dish. Stir halfway through cooking.	2 Minutes
<b>Parsnips &amp; Spinach (fresh)</b>	5-6 Minutes 225g (8oz)	HIGH	• Slice. Add 45ml (3tbsp) water. Cover dish. Stir halfway through cooking.	2 Minutes
<b>Peas (fresh)</b>	4-5 Minutes 225g (8oz)	HIGH	• Add 30ml (2tbsp) water. Cover dish. Stir halfway through cooking.	2 Minutes
<b>Potatoes, Jacket (250g (9oz) each) (fresh)</b>	10-11 Minutes 2 potatoes	HIGH	• Prick in several places. Place on the edge of the turntable.	4 Minutes
<b>Potatoes, boiled (old &amp; new) (fresh)</b>	9-10 Minutes 450g (1lb)	HIGH	• Cut into quarters. Add 60ml (4tbsp) water. Cover. Stir halfway through cooking.	4 Minutes
<b>Swede &amp; Turnips (fresh)</b>	7-8 Minutes 225g (8oz)	HIGH	• Dice. Add 45ml (3tbsp) water. Cover dish. Stir halfway through cooking.	2 Minutes
<b>Beans &amp; Cabbage (green) (frozen)</b>	5-6 Minutes 225g (8oz)	HIGH	• Place in a dish. Add 15ml (1tbsp) water. Cover. Stir halfway through cooking.	2 Minutes
<b>Broccoli, Leaf Spinach &amp; Brussels Sprouts (frozen)</b>	6-7 Minutes 225g (8oz)	HIGH	• Place in a dish. Add 15ml (1tbsp) water. Cover. Stir halfway through cooking.	2 Minutes
<b>Carrots (sliced) (frozen)</b>	6 Minutes 225g (8oz)	HIGH	• Place in a dish. Add 15ml (1tbsp) water. Cover. Stir halfway through cooking.	3 Minutes
<b>Cauliflower (florets) (frozen)</b>	5-6 Minutes 225g (8oz)	HIGH	• Place in a dish. Add 15ml (1tbsp) water. Cover. Stir halfway through cooking.	2 Minutes
<b>Corn on the Cob (frozen)</b>	10-11 Minutes 2 cobs	HIGH	• Place in a dish. Cover. Turn over halfway through cooking.	3 Minutes
<b>Peas, Sweetcorn &amp; Mixed Vegetables (frozen)</b>	5-6 Minutes 225g (8oz)	HIGH	• Place in a dish. Cover. Stir halfway through cooking.	2 Minutes
<b>Apples Rhubarb</b>	5-6 Minutes 450g (1lb)	HIGH	• Peel and slice. Place in a dish and cover. Stir during cooking.	2 Minutes
<b>Blackberries, Raspberries Blackcurrants Redcurrants Gooseberries</b>	5-6 Minutes 450g (1lb)	HIGH	• Place in a dish and cover. Stir during cooking.	2 Minutes

**Note:** Ensure you read all cookery notes on page 31, for advice and explanation of symbols before proceeding.

## MICROWAVE COOKING

FOOD	COOKING TIME	MICRO POWER LEVEL	METHOD	STANDING TIME
<b>White rice (long grain)</b>	14-15 Minutes	MEDIUM HIGH	• Add 300ml (1/2 pint) boiling water/100g (4oz) rice. Do not cover. Stir twice during cooking.	5 Minutes
<b>Brown rice</b>	21-22 Minutes	MEDIUM HIGH	• Add 400ml (14fl.oz) boiling water/100g (4oz) rice. Do not cover. Stir twice during cooking.	5 Minutes
<b>Spaghetti (short cut) Pasta shells/ twists</b>	11-12 Minutes	MEDIUM HIGH	• Add 300ml (1/2 pint) boiling water/100g (4oz) pasta. Do not cover. Stir halfway through cooking.	4 Minutes
<b>Macaroni (short cut)</b>	12-13 Minutes	MEDIUM HIGH	• Add 300ml (1/2 pint) boiling water/100g (4oz) pasta. Do not cover. Stir halfway through cooking.	4 Minutes
<b>Tagliatelle</b>	10-11 Minutes	MEDIUM HIGH	• Add 300ml (1/2 pint) boiling water/100g (4oz) pasta. Do not cover. Stir halfway through cooking.	4 Minutes
<b>Scrambled Eggs</b>	15g (1/2 oz) butter 2 eggs (size 3) 30ml (2tbsp) milk salt & pepper	HIGH	• Melt butter in a bowl on HIGH for 30 seconds. Add eggs, milk, season, mix well. Cook on HIGH for 2 minutes, stirring every 30 seconds.	30 Seconds
<b>Baked/ Poached Eggs</b>	2 eggs (size 3)	HIGH	• Break each egg into a ramekin dish. Carefully pierce white and yolk in 3-4 places. Cover and cook on HIGH for 1 minute.	30 Seconds
<b>Fried Eggs</b>	10ml (2tsp) oil 1 egg (size 3)	HIGH	• Place the oil in a 17.8cm (7") shallow dish. Heat on HIGH for 1 minute. Break the egg into the oil. Pierce yolk and white in 3-4 places. Cook on HIGH for 40-50 seconds.	30 Seconds

**Note:** Ensure you read all cookery notes on page 31, for advice and explanation of symbols before proceeding.

## GRILLING - (TOP GRILL ONLY)

FOOD	METHOD	COOKING TIME	COOKING MODE
<b>Bacon</b>	• Place in a flan dish on the high rack. Turn over halfway through cooking. Stand for 1-2 minutes after cooking.	8 Minutes for 1-6 rashers	GRILL
<b>Sausages/ Burgers (Thick/Thin)</b>	• Place on the high rack in a flan dish. Turn over halfway through cooking. Stand for 3 minutes after cooking.	10-12 Minutes for 1-2 steaks	GRILL
<b>Fish Fingers (frozen)</b>	• Place on the high rack in a flan dish. Turn over halfway through cooking. Stand for 2 minutes after cooking.	12 Minutes for 1-12 fingers	GRILL
<b>Toast</b>	• Place on the high rack. Turn over after 3 minutes. No standing time is required.	5 Minutes for 1-4 slices	GRILL
<b>Cheese on toast</b>	• Place bread on the high rack. Grill one side for 3 minutes turn over and cover with 50g (2oz) grated cheese. Grill for 3 mins. No standing time is required.	6 Minutes for 2 slices	GRILL
<b>Tea cakes &amp; Muffins &amp; crumpets</b>	• Slice in half. Place on the high rack. Turn over halfway through cooking. No standing time is required.	5 Minutes for 1-4 halves	GRILL



## DUAL GRILL - (MICROWAVE & TOP GRILL)

FOOD	METHOD	COOKING TIME	COOKING MODE
<b>Beef (rare)</b>	<ul style="list-style-type: none"> <li>Place fat side down in a flan dish on the low rack. Calculate the cooking time. Use sequence programming:  <b>Stage 1:</b> Cook on MEDIUM HIGH for first half of cooking time. Turn over, remove juices.  <b>Stage 2:</b> Cook on MEDIUM for second half of cooking time.  <b>Stage 3:</b> Cook on DUAL GRILL, MEDIUM for the final 4 minutes of cooking time. Stand for 6-8 minutes after cooking.</li> </ul>	12-13 Minutes per 450g (1lb)	<b>Stage 1:</b> MEDIUM HIGH. <b>Stage 2:</b> MEDIUM. <b>Stage 3:</b> DUAL GRILL, MEDIUM.
<b>Beef/Lamb (medium)</b>	<ul style="list-style-type: none"> <li>As above</li> </ul>	14-15 Minutes per 450g (1lb)	as above
<b>Beef/Lamb (well done)</b>	<ul style="list-style-type: none"> <li>As above</li> </ul>	18-19 Minutes per 450g (1lb)	as above
<b>Pork</b>	<ul style="list-style-type: none"> <li>Place fat side down in a flan dish on the low rack. Calculate the cooking time. Use sequence programming:  <b>Stage 1:</b> Cook on MEDIUM HIGH throughout, apart from the last 4 minutes. Turn over, remove juices halfway through <b>Stage 1</b>.  <b>Stage 2:</b> Cook on DUAL GRILL, MEDIUM HIGH for the final 4 minutes of cooking time. Stand for 10 minutes after cooking.</li> </ul>	21 Minutes per 450g (1lb)	<b>Stage 1:</b> MEDIUM HIGH. <b>Stage 2:</b> DUAL GRILL, MEDIUM HIGH.
<b>Poultry (Max. 1.8kg (4lb))</b>	<ul style="list-style-type: none"> <li>Place breast side down in a flan dish on the low rack. Calculate the cooking time. Use sequence programming:  <b>Stage 1:</b> Cook on HIGH throughout, apart from the last 4 minutes. Turn over, remove juices halfway through <b>Stage 1</b>.  <b>Stage 2:</b> Cook on DUAL GRILL, HIGH for the final 4 minutes of cooking time. Stand for 10 minutes after cooking.</li> </ul>	12 Minutes per 450g (1lb)	<b>Stage 1:</b> HIGH. <b>Stage 2:</b> DUAL GRILL, HIGH.
<b>Chicken Portions</b>	<ul style="list-style-type: none"> <li>Place best side down in a flan dish on the high rack. Calculate the cooking time. Use sequence programming:  <b>Stage 1:</b> Cook on HIGH throughout cooking time, apart from the last 4 minutes. Turn over, remove juices halfway through <b>Stage 1</b>.  <b>Stage 2:</b> Cook on DUAL GRILL, HIGH for the final 4 minutes of cooking time. Stand for 5 minutes after cooking.</li> </ul>	12 Minutes per 450g (1lb)	<b>Stage 1:</b> HIGH. <b>Stage 2:</b> DUAL GRILL, HIGH.
<b>Pork chops (with bone)</b>	<ul style="list-style-type: none"> <li>Place in a flan dish on the high rack. Turn over halfway through cooking. Stand for 3-4 minutes after cooking.</li> </ul>	12-13 Minutes per 450g (1lb) chops	DUAL GRILL, MEDIUM HIGH.
<b>Lamb chops &amp; Boneless Pork Chops</b>	<ul style="list-style-type: none"> <li>As above</li> </ul>	10-11 Minutes per 450g (1lb) chops	DUAL GRILL, MEDIUM HIGH.
<b>Sausages (thick)</b>	<ul style="list-style-type: none"> <li>Place in a flan dish on the high rack. Turn over after halfway through cooking. Stand for 2-3 minutes after cooking.</li> </ul>	10 Minutes per 450g (1lb) sausages	DUAL GRILL, MEDIUM.
<b>Beefburgers (frozen)</b>	<ul style="list-style-type: none"> <li>As above</li> </ul>	9-10 Minutes per 450g (1lb) beefburgers	DUAL GRILL, MEDIUM LOW.

**Note:** Ensure you read all cookery notes on page 31, for advice and explanation of symbols before proceeding.

## DUAL GRILL - (MICROWAVE & TOP GRILL)

FOOD	METHOD	COOKING TIME	COOKING MODE
<b>Crispy crumb foods (chilled)</b>	<ul style="list-style-type: none"> <li>Place in a flan dish on the high rack. Use sequence programming:  <b>Stage 1:</b> Cook on DUAL GRILL, MEDIUM LOW for first half of cooking time. Turn over.  <b>Stage 2:</b> GRILL for second half of cooking time.            ▲ Stand for 2-3 minutes after cooking.</li> </ul>	9-10 Minutes for 100g (4oz)	<b>Stage 1:</b> DUAL GRILL, MEDIUM LOW. <b>Stage 2:</b> GRILL.
	<ul style="list-style-type: none"> <li>As above</li> </ul>	11-12 Minutes for 200g (7oz)	<b>Stage 1:</b> DUAL GRILL, MEDIUM LOW. <b>Stage 2:</b> GRILL.
	<ul style="list-style-type: none"> <li>As above</li> </ul>	12-13 Minutes for 400g (14oz)	<b>Stage 1:</b> DUAL GRILL, MEDIUM LOW. <b>Stage 2:</b> GRILL.
<b>Crispy crumb foods (frozen)</b>	<ul style="list-style-type: none"> <li>Place in a flan dish on the high rack. Turn over halfway through cooking.            ▲ Stand for 2-3 minutes after cooking.</li> </ul>	10 Minutes for 100g (4oz)	DUAL GRILL, MEDIUM.
	<ul style="list-style-type: none"> <li>As above</li> </ul>	11-12 Minutes for 200g (7oz)	DUAL GRILL, MEDIUM.
	<ul style="list-style-type: none"> <li>As above</li> </ul>	12-13 Minutes for 400g (14oz)	DUAL GRILL, MEDIUM.
<b>Oven chips (frozen)</b>	<ul style="list-style-type: none"> <li>Place in a flan dish on the high rack. Turn over halfway through cooking. No standing time is required.</li> </ul>	11 Minutes for 225g (8oz)	DUAL GRILL, MEDIUM LOW.
	<ul style="list-style-type: none"> <li>As above</li> </ul>	12-13 Minutes for 450g (1lb)	DUAL GRILL, MEDIUM LOW.
<b>Baked Potatoes</b>	<ul style="list-style-type: none"> <li>Pierce each potato in several places. Place in a flan dish on the low rack. Turn over after 8 minutes of the cooking time. No standing time is required.</li> </ul>	16-17 Minutes for 2 potatoes (each 250g)	DUAL GRILL, MEDIUM HIGH.
<b>Roast Potatoes</b>	<ul style="list-style-type: none"> <li>Cut into even sized pieces. Brush with oil. Place in a flan dish on the low rack. Turn over halfway through cooking. No standing time is required.</li> </ul>	24-25 Minutes for a 675g (1½lb) potatoes	DUAL GRILL, MEDIUM.
<b>Garlic Bread</b>	<ul style="list-style-type: none"> <li>Remove any packaging. Place in a flan dish on the low rack. No standing time is required.</li> </ul>	6 Minutes for 1 baguette.	DUAL GRILL, LOW.
<b>Toasted Sandwich</b>	<ul style="list-style-type: none"> <li>Prepare sandwich: Place two slices of ham and 50g (2oz) grated cheese between 2 slices of bread and butter. Place sandwich in a flan dish on the high rack. Turn over after 3 minutes of the cooking time. No standing time is required.</li> </ul>	6 Minutes for 1 sandwich	DUAL GRILL, LOW.

**Note:** Ensure you read all cookery notes on page 31, for advice and explanations of symbols before proceeding.

## DOUBLE (TOP AND BOTTOM) GRILLS

FOOD	METHOD	COOKING TIME	COOKING MODE
<b>Beefburgers (frozen)</b>	<ul style="list-style-type: none"> <li>Place directly onto the turntable. Turn over halfway through cooking.</li> </ul>	8 minutes for 225g (4 burgers) 12 minutes for 400g (8 burgers)	TOP & BOTTOM GRILLS TOP & BOTTOM GRILLS
<b>Chicken Breast Fillet (chilled)</b>	<ul style="list-style-type: none"> <li>Pierce skin, place directly onto the turntable. Turn over halfway through cooking.</li> </ul>	18 minutes for 150g (1 fillet) 20 minutes for 450g (3 fillets)	TOP & BOTTOM GRILLS TOP & BOTTOM GRILLS
<b>Crispy Crumb Foods (chilled)</b>	<ul style="list-style-type: none"> <li>Place directly onto the turntable. Turn over halfway through cooking.</li> </ul>	8-10 minutes for 100g 12-14 minutes for 300g 18-20 minutes for 600g	TOP & BOTTOM GRILLS TOP & BOTTOM GRILLS TOP & BOTTOM GRILLS
<b>Lamb Chops &amp; Boneless Pork Chops</b>	<ul style="list-style-type: none"> <li>Place directly onto the turntable. Turn over halfway through cooking.</li> </ul>	10-12 minutes for 100g 12-14 minutes for 300g 16-18 minutes for 600g	TOP & BOTTOM GRILLS TOP & BOTTOM GRILLS TOP & BOTTOM GRILLS
<b>Pork Chops (with bone)</b>	<ul style="list-style-type: none"> <li>Place directly onto the turntable. Turn over halfway through cooking.</li> </ul>	12-14 minutes for 100g 14-16 minutes for 300g 18-20 minutes for 600g	TOP & BOTTOM GRILLS TOP & BOTTOM GRILLS TOP & BOTTOM GRILLS
<b>Pizza, Chilled (thin &amp; deep)</b>	<ul style="list-style-type: none"> <li>Place directly onto the turntable. For the 1st stage of cooking use top and bottom grills then the 2nd stage use the top grill only.</li> </ul>	For 200g 1st stage 4 minutes 2nd stage 4 minutes For 400g 1st stage 6 minutes 2nd stage 4 minutes For 800g 1st stage 8 minutes 2nd stage 4 minutes	TOP & BOTTOM GRILLS TOP GRILL ONLY TOP & BOTTOM GRILLS TOP GRILL ONLY TOP & BOTTOM GRILLS TOP GRILL ONLY
<b>Oven Chips (frozen)</b>	<ul style="list-style-type: none"> <li>Place directly onto the turntable. Turn over halfway through cooking.</li> </ul>	10 minutes for 100g 12-14 minutes for 200g 16-18 minutes for 400g	TOP & BOTTOM GRILLS TOP & BOTTOM GRILLS TOP & BOTTOM GRILLS
<b>Sausages (thick)</b>	<ul style="list-style-type: none"> <li>Pierce skin, place directly onto the turntable. Turn over halfway through cooking.</li> </ul>	10 minutes for 225g 18 minutes for 450g	TOP & BOTTOM GRILLS TOP & BOTTOM GRILLS
<b>Sausages (thin)</b>	<ul style="list-style-type: none"> <li>Pierce skin, place directly onto the turntable. Turn over halfway through cooking.</li> </ul>	8 minutes for 225g 12 minutes for 450g	TOP & BOTTOM GRILLS TOP & BOTTOM GRILLS
<b>Gammon Steak</b>	<ul style="list-style-type: none"> <li>Place directly onto the turntable. Turn over halfway through cooking.</li> </ul>	8-10 minutes for 100g 10-12 minutes for 225g	TOP & BOTTOM GRILLS TOP & BOTTOM GRILLS
<b>Toasted Sandwich</b>	<ul style="list-style-type: none"> <li>Place two slices of ham and 50g (2oz) grated cheese between two slices of bread and butter. Place directly onto the turntable. Turn over after four minutes.</li> <li>As above, double the ingredients. Turn over after five minutes.</li> </ul>	6 minutes for 1 sandwich  7 minutes for 2 sandwiches	TOP & BOTTOM GRILLS  TOP & BOTTOM GRILLS



## DUAL CONVECTION - (MICROWAVE AND CONVECTION))

FOOD	METHOD	COOKING TIME	COOKING MODE
<b>Beef (rare)</b>	<ul style="list-style-type: none"> <li>Place on the low rack. Calculate cooking time.</li> </ul>	15-16 Minutes for 450g (1lb)	DUAL CONVECTION 100°C MEDIUM
<b>Beef/Lamb (medium)</b>	<ul style="list-style-type: none"> <li>As above.</li> </ul>	17-18 Minutes for 450g (1lb)	DUAL CONVECTION 100°C MEDIUM
<b>Beef/Lamb (well done)</b>	<ul style="list-style-type: none"> <li>As above.</li> </ul>	20-21 Minutes for 450g (1lb)	DUAL CONVECTION 100°C MEDIUM
<b>Pork</b>	<ul style="list-style-type: none"> <li>Place on the low rack. Calculate the cooking time. Use sequence programming. Cook on DUAL CONVECTION 160°C, MEDIUM.</li> </ul>	18-19 Minutes for 450g (1lb)	DUAL CONVECTION 160°C MEDIUM
<b>•Poultry (Max. 3½ kg 8lb)</b>	<ul style="list-style-type: none"> <li>Place breast side up on the low rack. Stand for 10 minutes after cooking.</li> </ul>	11-12 Minutes for 450g (1lb)	DUAL CONVECTION 200°C MEDIUM
<b>Quiche (uncooked, frozen)</b>	<ul style="list-style-type: none"> <li>Preheat oven to 200°C. Remove from foil container. Place in a flan dish on the low rack. Stand for 3-4 minutes after cooking.</li> </ul>	21-22 Minutes for a 450g (1lb) quiche	Preheated oven. DUAL CONVECTION 200°C MEDIUM LOW
<b>Meat Pie (uncooked, frozen)</b>	<ul style="list-style-type: none"> <li>Preheat oven to 200°C. Remove from foil container. Glaze and place in a flan dish on the low rack. Stand for 3-4 minutes after cooking.</li> </ul>	29-30 Minutes for a 450g (1lb) pie	Preheated oven. DUAL CONVECTION 200°C MEDIUM LOW
<b>Fruit Pie (uncooked, frozen)</b>	<ul style="list-style-type: none"> <li>Preheat oven to 200°C. Remove from foil container. Glaze and place in a flan dish on the low rack. Stand for 3-4 minutes after cooking.</li> </ul>	24-25 Minutes for a 450g (1lb) pie	Preheated oven. DUAL CONVECTION 200°C MEDIUM LOW
<b>Sausage Rolls (uncooked, frozen)</b>	<ul style="list-style-type: none"> <li>Preheat oven to 220°C. Glaze and place in a flan dish on the low rack. Stand for 3-4 minutes after cooking.</li> </ul>	11-12 Minutes for 6 sausage rolls (approx. 50g, 2oz each)	Preheated oven. DUAL CONVECTION 220°C MEDIUM LOW
<b>Garlic Bread</b>	<ul style="list-style-type: none"> <li>Preheat oven to 220°C. Remove any packaging. Place in a flan dish on the low rack. No standing time is required.</li> </ul>	6 Minutes for 1 baguette	Preheated oven. DUAL CONVECTION 230°C LOW
<b>Baked Potatoes</b>	<ul style="list-style-type: none"> <li>Preheat oven to 250°C. Pierce each potato in several places. Place on the low rack. No standing time is required.</li> </ul>	14-15 Minutes for a 500g (1lb 2oz) (each weighing 250g)	Preheated oven. DUAL CONVECTION 250°C MEDIUM HIGH
<b>Roast Potatoes</b>	<ul style="list-style-type: none"> <li>Cut into even sized pieces. Brush with oil. Place in a flan dish on the low rack. No standing time is required.</li> </ul>	35 Minutes for 675g (1½lb) potatoes	Preheated oven. DUAL CONVECTION 220°C MEDIUM LOW

\* For poultry weighing 2.4kg or more, place in a flan dish on the turntable.

# MICROWAVE REHEATING

FOOD	METHOD	COOKING TIME	COOKING MODE
<b>Canned foods (soups, beans, vegetables, etc.)</b>	<ul style="list-style-type: none"> <li>Remove from the can. Place in a dish, cover. Stir halfway through cooking. Stand for 2 minutes after cooking.</li> </ul>	5-6 Minutes for 425g (15oz) can	HIGH
<b>Christmas pudding</b>	<ul style="list-style-type: none"> <li>Place in a flan dish. Do not exceed cooking time advised by food manufacturer. Stand for 30 seconds after cooking. As above</li> </ul>	40-50 seconds for 125g (5oz) slice	MEDIUM HIGH
	<ul style="list-style-type: none"> <li>Place in a flan dish. Do not exceed cooking time advised by food manufacturer. Stand for 1 minute after cooking.</li> </ul>	1 Minute for 175g (6oz) pudding 4-5 Minutes for 450g (1lb) pudding	MEDIUM HIGH MEDIUM HIGH
<b>Bread rolls/ Croissants</b>	<ul style="list-style-type: none"> <li>Place on the turntable</li> </ul>	20-30 seconds for 2	MEDIUM HIGH
<b>Sausage rolls (cooked, chilled approx. 50g (2oz) each)</b>	<ul style="list-style-type: none"> <li>Place in a flan dish on the low rack. Stand for 2 minutes after cooking.</li> </ul>	6 Minutes for 6 sausage rolls	DUAL GRILL, MEDIUM LOW.
<b>Quiche, (cooked, chilled)</b>	<ul style="list-style-type: none"> <li>Remove foil container. Place in a flan dish on the low rack. Stand for 3 minutes after cooking.</li> </ul>	11-12 Minutes for 450g (1lb) quiche	DUAL GRILL, MEDIUM LOW.
<b>Meat Pie (cooked, chilled)</b>	<ul style="list-style-type: none"> <li>Remove foil container. Place in a flan dish on the low rack. Stand for 3 minutes after cooking.</li> </ul>	7-8 Minutes for 450g (1lb) pie	DUAL GRILL, MEDIUM.
<b>Fruit Pie (cooked, chilled)</b>	<ul style="list-style-type: none"> <li>Remove foil container. Place in a flan dish on the low rack. Stand for 3 minutes after cooking.</li> </ul>	8-9 Minutes for 450g (1lb) pie	DUAL GRILL, LOW.

**Note:** Ensure you read all cookery notes on page 31, for advice and explanation of symbols before proceeding.

## CONVERSION CHARTS

WEIGHT MEASURES		VOLUME MEASURES		SPOON MEASURES	
15g	1/2oz	30ml	1floz	125ml	1/4 teaspoon
25g	1oz	100ml	3floz	2.5ml	1/2 teaspoon
50g	2oz	150ml	5floz (1/4 pint)	5ml	1 teaspoon
100g	4oz	300ml	10floz (1/2 pint)	15ml	1 tablespoon
175g	6oz	600ml	20floz (1 pint)		
225g	8oz				
450g	1lb				

## STARTERS

### MUSHROOM SOUP

SERVES 4

- 1 medium onion, chopped
- 175g (6oz) mushrooms, sliced
- 25g (1oz) butter
- 25g (1oz) plain flour
- 450ml (¾ pint) hot vegetable stock
- 2.5ml (½ tsp) dried marjoram (see Tip, page 50)
- salt and pepper to taste
- 300ml (½ pint) milk

PREPARATION TIME - 6 MINUTES

- 1 Cook the onion, mushrooms and butter together in a bowl on HIGH for 4 minutes.
- 2 Stir in the flour to form a paste, gradually add the stock.
- 3 Stir in the marjoram, salt and pepper to taste. Cook on HIGH for 8-9 minutes, stir after 4 minutes.
- 4 Blend and add the milk, cook on HIGH for 6 minutes.

### BROCCOLI & BLUE CHEESE SOUP

SERVES 4

- 15ml (1tbsp) sunflower oil
- 1 large onion, finely chopped
- 400g (14oz) broccoli, broken into small florets
- 1 litre (1¾ pints) hot vegetable stock
- 300ml (½ pint) low fat natural yoghurt
- 100g (4oz) Blue Stilton/Danish Blue, crumbled
- salt and pepper to taste

PREPARATION TIME - 8 MINUTES

- 1 Place oil, onion and broccoli in a large bowl, mix well. Cover and cook on HIGH for 4-5 minutes.
- 2 Add the stock, mix well. Cover and cook on HIGH for 8-10 minutes.
- 3 Blend in a food processor. Return to bowl, stir in yoghurt and cheese. Season. Heat on MEDIUM HIGH for 6-7 minutes, stir every 2 minutes.

### BAKED AVOCADOS WITH HAM

SERVES 2 OR 4

- 50g (2oz) butter
- 50g (2oz) fresh brown breadcrumbs
- 100g (4oz) cooked ham, finely chopped
- 90ml (6tbsp) double cream
- salt and pepper to taste
- 5ml (1tsp) fresh parsley, chopped
- 2 large ripe avocados (see Tip, page 51)
- 15ml (1tbsp) lemon juice (see Tip, page 43)
- 50g (2oz) cheese, grated

*Garnish with fresh sprigs of parsley to serve*

PREPARATION TIME - 8 MINUTES

- 1 Place the butter in a bowl and heat on HIGH for 1 minute. Stir in the breadcrumbs and ham, add enough cream to bind the mixture. Season with salt and pepper to taste and stir in the parsley, cook on HIGH for 2-3 minutes.
- 2 Cut the avocados in half, remove the stone and brush the flesh with lemon juice. Fill each avocado half with the breadcrumb mixture.
- 3 Place the avocados in a large flan dish and sprinkle with the grated cheese.
- 4 Place the dish on the high rack, use sequence programming (see page 20) to cook on HIGH for 1 minute, then on GRILL for 6-7 minutes until brown and crispy.

### CRISPY STUFFED MUSHROOMS

SERVES 4

- 12 medium open cap mushrooms
- 75g (3oz) butter
- 2 cloves garlic, crushed (See Tip, page 48)
- 75g (3oz) fresh breadcrumbs
- 50g (2oz) cheese, grated

**Variation:**

*Stilton Stuffed Mushrooms: Omit garlic and grated cheese. Add 100g (4oz) Stilton, crumbled at Stage 2.*

PREPARATION TIME - 6 MINUTES

- 1 Remove and chop mushroom stalks. Place mushroom caps in a large flan dish open side up.
- 2 Heat butter with garlic on HIGH for 1 minute, stir in chopped mushroom stalks and breadcrumbs. Fill mushrooms with mixture, sprinkle with cheese.
- 3 Place directly on the turntable, cook on GRILL-3 (top and bottom grill) (see page 10), for 10 minutes.

### TURKEY FEUILLETES

---

SERVES 6

**450g diced turkey thigh meat (1cm x 1cm)**  
**25g (1oz) butter**  
**6 rashers streaky bacon, rind removed & sliced**  
**1 small onion, finely chopped**  
**25g (1oz) flour**  
**284ml chicken stock**  
**50g (2oz) chestnut mushrooms, thinly sliced**  
**55ml creme fraiche or double cream**  
**1½ tbsp parsley, finely chopped**  
**550g puff pastry**  
**1 egg size 3, beaten**

PREPARATION TIME - 15 MINUTES

- 1 Melt the butter for 1 minute on HIGH. Add the bacon, onion and turkey and cook for 6 minutes on HIGH.
- 2 Sprinkle in the flour and add the chicken stock. Cook for 8 minutes on HIGH. Then add the mushrooms. Season well. Cook for 5 minutes at MEDIUM. Stir twice.
- 3 Stir in the creme fraiche or double cream and parsley. Leave until completely cooled.
- 4 Roll out 6 squares of pastry measuring 7 x 7". Divide the filling into six and place in the centre.
- 5 Brush the edges with the egg. Pull up opposite corners to meet in the centre, then pinch the seams together carefully.
- 6 Brush all over with egg and place on a greased baking tray and cook for 20 minutes on 200°C.

### CHEESY FISH GOUJONS

---

SERVES 4

**450g (1lb) white fish fillets**  
**100g (4oz) fresh white breadcrumbs**  
**50g (2oz) Parmesan cheese**  
**salt and pepper to taste**  
**1 egg (size 3), beaten**  
**olive oil**

PREPARATION TIME - 8 MINUTES

- 1 Cut fish into thin strips approx. 6.4cm (2.5") long.
- 2 Combine breadcrumbs and cheese. Season.
- 3 Dip fish strips first into egg, then into breadcrumb mixture, coat evenly.
- 4 Brush the turntable with olive oil and spread the coated fish in a single layer over the base.
- 5 Cook on GRILL-3 (top and bottom grill) for 12 minutes. Turn over after 7 minutes.

**Microwave Tip: More juice from oranges & lemons**

Cut fruit in half and pierce with a fork. Place in a shallow flan dish, cut side down. Heat on HIGH for 2 minutes.

### POACHED SALMON WITH MUSTARD SAUCE

---

SERVES 4

**4 salmon steaks (approx. 200g (7oz) each)**  
**45ml (3tbsp) dry white wine**  
**300ml (½ pint) mustard sauce (see page 58)**  
**sprig of fresh rosemary to garnish**

*Garnish with rosemary.*

PREPARATION TIME - 6 MINUTES

- 1 Place the salmon steaks in a flan dish, pierce in several places. Add the wine. Cover and cook on HIGH for 8-9 minutes. Allow to stand whilst preparing the sauce.
- 2 Prepare the Mustard Sauce, see page 59.
- 3 Place salmon steaks in a serving dish, reheat on HIGH for 1 minute. Serve the sauce separately.

### GARLIC PRAWNS

---

SERVES 6

**50g (2oz) butter**  
**3 cloves garlic, crushed (see Tip, page 47)**  
**250g (9oz) tiger prawns, cooked and peeled**  
**15ml (1tbsp) fresh parsley, chopped**

**Variation:**

**Garlic Mushrooms:** Substitute prawns with 175g (6oz) mushrooms cut into quarters.

PREPARATION TIME - 4 MINUTES

- 1 Heat the butter on HIGH for 1 minute. Stir in the garlic and cook on HIGH for a further minute.
- 2 Stir in the prawns and cook on MEDIUM for 7 minutes, stirring every minute. Sprinkle with parsley to serve. Serve in ramekin dishes with French bread.

## FISH

---

### FISH CRUMBLE PIE

---

**SERVES 4**

**450g (1lb) white fish fillets (Cod or Haddock)**

**50g (2oz) butter**

**2 small courgettes, sliced**

**100g (4oz) mushrooms, sliced**

**75g (3oz) peas**

**300ml (1/2 pint) white sauce (see Page 58)**

**2.5ml (1/2 tsp) dried marjoram (see Page 49)**

**2.5ml (1/2 tsp) dried thyme (see Page 49)**

**salt and pepper to taste**

**crumble:**

**125g (5oz) plain flour**

**75g (3oz) jumbo oats**

**100g (4oz) margarine**

**50g (2oz) cheese, grated**

**1.25ml (1/4 tsp) dried marjoram (see page 49)**

**salt and pepper to taste**

**PREPARATION TIME - 12 MINUTES**

- 1 Arrange fish in a single layer in a large flan dish. Cover and cook on HIGH for 5-6 minutes.
- 2 Place butter, courgette, mushrooms and peas in a 2.5 litre (approx. 4 pint) casserole dish. Cover and cook on HIGH for 2-3 minutes. Stir in flaked fish.
- 3 Stir herbs into sauce. Season. Add to fish mixture.
- 4 To prepare crumble, place the flour and oats in a bowl, rub in the margarine until the mixture resembles breadcrumbs. Spread crumble over the fish mixture and sprinkle generously with cheese and marjoram. Season.
- 5 Place on the low rack and bake on DUAL CONVECTION, 200°C, MEDIUM for 20 minutes.

### SALMON AND CHEESE PARCELS

---

**SERVES 4**

**225g (8oz) salmon fillet, chopped**

**225g (8oz) canned asparagus, chopped**

**225g (8oz) cream cheese and chives**

**Salt and pepper to taste**

**15ml (1tbsp) fresh dill, chopped**

**450g (1lb) puff pastry**

**1 egg to glaze**

**Fresh chives, chopped to garnish**

**PREPARATION TIME - 18 MINUTES**

- 1 Place the salmon, cream cheese, asparagus, seasoning and dill in a bowl, mix well. Cook for 2 minutes on MEDIUM HIGH, stirring once. Leave to cool.
- 2 Preheat the oven to 200°C.
- 3 Roll out and cut pastry into four 15.3cm (7") squares.
- 4 Divide salmon and mixture into 4 and place in the centre of each square. Brush edges with egg. Form parcels by folding the corners over the filling. Pinch edges to form a raised edge. Brush with egg. Place in two large, greased flan dishes or round baking trays.
- 5 Place one dish on the low rack, the other on the high rack. Cook on 200°C for 20 minutes. Swap over the trays and cook for a further 10 minutes until golden.

### FISH KEBABS

---

**SERVES 4**

**4 wooden skewers (see Tip, page 49)**

**2 courgettes, cut into 8 chunks**

**4 medium mushrooms, stalks removed**

**450g (1lb) firm fleshed fish skinned and cut into 8 cubes**

**4 slices of orange**

**2 firm medium tomatoes, halved**

**5ml (1tsp) fresh dill, chopped**

**50g (2oz) butter**

**PREPARATION TIME - 10 MINUTES**

- 1 Thread pieces of courgette, mushroom, fish, orange and tomato onto each skewer in a regular sequence. Leave no wood exposed.
- 2 Heat the dill and butter in a small bowl on HIGH for 1 minute. Brush kebabs with the dill butter, place in a flan dish on the high rack.
- 3 Cook on DUAL GRILL-1 (see page 11), MEDIUM for 12 minutes. Turn over and rearrange the kebabs every 3-4 minutes.

## BACON AND STILTON PIE

SERVES 6

175g self raising flour

pinch of salt

88g shredded suet

1 tbsp olive oil

1 small onion, chopped

100g back bacon, diced

225g leeks, thinly sliced

75g stilton, crumbled

4 tbsp single cream

seasoning

beaten egg to glaze

PREPARATION TIME - 15 MINUTES

- 1 Sift the flour and salt into a large mixing bowl and stir in the suet.
- 2 Gradually mix in 150ml water until you have a soft dough, knead lightly on a floured work surface, roll out a bottom and top.
- 3 Cook onion and bacon in oil for 3 minutes on HIGH.
- 4 Add leeks and cook for 5 minutes on HIGH.
- 5 Stir in the Stilton, the cream and seasoning.
- 6 Put the filling on the pastry.
- 7 Seal the pie with the top and brush with egg.
- 8 Bake for 15 minutes on DUAL COOK MEDIUM LOW 250°C.

## BOLOGNESE SAUCE

SERVES 4

50g (2oz) butter

45ml (3tbsp) vegetable oil

2 small onions, finely chopped

2 sticks of celery, finely chopped

2 cloves garlic, crushed (see Tip, page 47)

3 rashers of bacon, finely chopped

1 bay leaf

400g (14oz) canned, chopped tomatoes

30ml (2tbsp) tomato purée

450g (1lb) lean minced meat

30ml (2tbsp) dried mixed herbs (see Tip, page 49)

300ml (1/2 pint) dry red wine

300ml (1/2 pint) hot stock

salt and pepper to taste

PREPARATION TIME - 12 MINUTES

- 1 Melt the butter and oil in a large bowl on HIGH for 1 minute. Stir in the onion, celery, garlic and bacon. Cover and cook on HIGH for 7-8 minutes.
- 2 Add the bay leaf, tomatoes, purée and minced meat to the vegetable mixture. Cook on HIGH for 9-10 minutes, stir 2-3 times during cooking.
- 3 Add herbs, wine, stock. Season, mix well. Cover and cook on HIGH for 5 minutes, then for 21-22 minutes on MEDIUM until sauce is thick. Stir 2-3 times during cooking. Serve hot with spaghetti.

**Shepherd's Pie:** Make as above, omit wine. Place in a dish and top with 700g (1 1/2lb) mashed potato. Place on turntable and cook on DUAL GRILL-1 (see page 12), MEDIUM HIGH for 9-10 minutes until evenly brown.

**Chilli con carne:** Make as above. At Stage 3 add 450g (1lb) canned red kidney beans (drained) and 5-15ml (1-3tsp) chilli powder, to taste.

## MEXICAN TACOS

SERVES 4

225g (8oz) lean minced beef, pork or lamb

2 cloves garlic, crushed (see Tip, page 47)

1 small onion, chopped

2 fresh, green chillies, chopped

225g (8oz) canned, chopped tomatoes

100g (4oz) canned, red kidney beans

8 taco shells, pre-cooked

175g (6oz) Cheddar cheese, grated

PREPARATION TIME - 15 MINUTES

- 1 Place the mince, garlic and onion in a bowl, mix well. Cook on HIGH for 7-8 minutes, stir twice.
- 2 Stir in chillies, tomatoes and beans. Cook on HIGH for 18 minutes. Place taco shells on kitchen paper on turntable. Heat on HIGH for 2 minutes. Fill with chilli bean mixture, sprinkle with cheese.
- 3 Pack tacos together, open end up in a large casserole or flan dish. Place on turntable, cook on DUAL GRILL-1 (see page 11), MEDIUM LOW for 7-8 minutes.

*Mexican dish of spicy filled corn tortillas. Serve with Guacamole, soured cream and crisp salad.*



## STEAK AND KIDNEY PUDDING

---

SERVES 4

**450g (1lb) stewing steak, chopped**  
**100g (4oz) kidney, chopped**  
**1 medium onion, chopped**  
**2.5ml (1/2tsp) dried mixed herbs (see Tip, page 49)**  
**450ml (3/4 pint) beef stock**  
**15ml (1tbsp) cornflour mixed with a little water**  
**pastry:**  
**225g (8oz) self-raising flour**  
**2.5ml (1/2tsp) salt**  
**5ml (1tsp) baking powder**  
**100g (4oz) suet**  
**150ml (1/4 pint) cold water**  
**15ml (1tbsp) milk**

---

PREPARATION TIME - 20 MINUTES

- 1 Place steak, kidney, onion, mixed herbs and stock in a casserole dish. Cover and cook on MEDIUM for 65-70 minutes. Stir after half the cooking time and add the cornflour to thicken.
- 2 To make the pastry, place the flour, salt, baking powder and suet in a bowl, mix well.
- 3 Add enough cold water to form a soft dough. Roll out <sup>2</sup>/<sub>3</sub> of the pastry and use it to line the base and sides of a greased 1.2 litre (2 pint) pudding basin.
- 4 Fill pastry lined basin with meat. Roll out remaining pastry, cut out a circle to cover pudding. Brush with milk. Make a slit in the centre. Cover with cling film, cook on HIGH for 13-14 minutes.

## SUMMER PORK CASSEROLE

---

SERVES 6

**450g potatoes, peeled and sliced**  
**4tbsp hot water**  
**450g pork fillet, cut into bite-sized pieces**  
**1 can peeled tomatoes**  
**4-6 small courgettes, sliced**  
**1tsp basil**  
**salt and pepper to taste**  
**100g grated cheese**

---

PREPARATION TIME - 10 MINUTES

- 1 Cook the potatoes with the water with a cover for 6 minutes on HIGH. Drain and remove the potatoes with a slotted spoon.
- 2 Add the pork, tomatoes, courgettes, basil and seasoning to taste. Cook for 15 minutes on HIGH, stirring half way.
- 3 Overlap the potatoes on top of the meat mixture around the edge of the dish.
- 4 Cover the potatoes with cheese, place on the low rack and cook on DUAL CONVECTION, 220°C, MEDIUM for 15 minutes.

## BEEF STROGANOFF

---

SERVES 4

**1kg (2lb) rump steak, cut into strips**  
**50g (2oz) plain flour**  
**salt and pepper to taste**  
**1 large onion, finely chopped**  
**30ml (2tbsp) tomato purée**  
**450ml (3/4 pint) hot beef stock**  
**150ml (1/4 pint) red wine**  
**100g (4oz) mushrooms, thinly sliced**  
**150ml (1/4 pint) soured cream**

---

PREPARATION TIME - 10 MINUTES

- 1 Place the steak, flour, salt and pepper in a 2.5 litre (approx. 4 pint) casserole dish, mix well.
- 2 Stir in the onion, purée, stock and wine. Cover and cook on MEDIUM for 50-55 minutes, stir 2-3 times during cooking.
- 3 Stir in mushrooms, cook on MEDIUM for 6-7 minutes.
- 4 Stir in the cream before serving.  
*Serve on a bed of tagliatelle or rice.*

## POULTRY

### CHICKEN SATAY

SERVES 4

**marinade:**

- 15ml (1tbsp) groundnut oil
- 15ml (1tbsp) lemon juice (see Tip, page 42)
- 30ml (2tbsp) satay sauce
- 1 clove garlic, crushed (see Tip, page 47)
- Tabasco sauce to taste
- 4 wooden skewers (see Tip, page 49)
- 450g (1lb) chicken fillets, cubed

PREPARATION TIME - 10 MINUTES

- 1 Place all the marinade ingredients in a large bowl, mix well. Stir in the chicken, refrigerate for 2 hours to marinate.
- 2 Thread the chicken onto skewers leaving no wood exposed. Place in a large flan dish on the high rack. Cook on DUAL GRILL-1 (see page 12), MEDIUM HIGH for 11-12 minutes. Turn over and rearrange skewers every 3 minutes.

### CHICKEN & CAMEMBERT PARCELS

SERVES 4

**CAMEMBERT AND SPRING ONION ENCASED IN TENDER CHICKEN FILLETS.**

- 4 large chicken breast fillets, skinned
- 100g (4oz) Camembert, finely chopped
- 3 spring onions, finely chopped
- 2.5ml (1/2tsp) dried parsley
- salt and pepper to taste
- cocktail sticks to secure
- 75g Cheddar cheese, grated

PREPARATION TIME - 12 MINUTES

- 1 Open out chicken breasts, flatten with a rolling pin.
- 2 Place Camembert, onions, parsley and seasoning in a bowl, mix well. Place a quarter of the mixture in the centre of each breast. Fold up into a tight parcel. Secure with cocktail sticks. Ensure no filling is visible.
- 3 Place the breasts seam side upwards.
- 4 Cook on DUAL GRILL MEDIUM HIGH for 16 minutes, turn over and add cheese after 8 minutes.

*Sprinkle with toasted almonds to serve.*

**Microwave Tip: Toasting Almonds**

Place 25g (1oz) almonds in a shallow flan dish with a knob of butter, heat on HIGH for 3 minutes, stir every minute until golden.

### CHICKEN KORMA

SERVES 6

A MILD FLAVOURED, CREAMY INDIAN DISH. SERVE WITH RICE AND POPPADUMS (SEE TIP, PAGE 51).

- 900g (2lb) chicken, cut into large pieces
- 175g (6oz) natural yoghurt
- 2 cloves garlic, crushed (see Tip, page 47)
- 25g (1oz) creamed coconut
- 10ml (2tsp) turmeric
- 25g (1oz) butter
- 1 large onion, sliced
- 5cm (2") piece fresh ginger, grated
- 2.5ml (1/2tsp) chilli powder
- 5ml (1tsp) coriander seeds
- 5 whole cloves
- 5ml (1tsp) cinnamon
- 10ml (2tsp) cornflour
- 100g (4oz) single cream
- 25g (1oz) roasted cashew nuts

PREPARATION TIME - 1 1/4 HOURS

- 1 Place chicken in a bowl, stir in yoghurt, garlic, creamed coconut and turmeric. Cover and marinate for at least 1 hour in the refrigerator.
- 2 Place butter in a large bowl, heat on HIGH for 1 minute, until melted. Add the onion and cook on HIGH for 2 minutes. Stir in the ginger, chilli powder and coriander, cook on HIGH for 1 minute.
- 3 Add the chicken and marinade, mix well. Stir in the cloves and cinnamon. Cover and cook on HIGH for 8-9 minutes, stirring after 3 minutes.
- 4 Rearrange the chicken pieces and cook on MEDIUM for 6-7 minutes.
- 5 Combine the cornflour with the cream and stir into the chicken. Cook on HIGH for 6 minutes, stir after 3 minutes. Sprinkle with cashew nuts.



## CHICKEN BREASTS PARMESAN

SERVES 6

IDEAL SERVED WITH NEW POTATOES, CRISP VEGETABLES AND A GLASS OF RED WINE.

**50g (2oz) fresh breadcrumbs**  
**50g (2oz) Parmesan cheese, freshly grated**  
**1 egg (size 3), beaten**  
**675g (1½lb) boneless chicken breasts**  
**25g (1oz) plain flour**  
**400g (14oz) canned chopped tomatoes**  
**1 clove garlic, crushed (see Tip, below)**  
**10ml (2tsp) fresh oregano, chopped**  
**300ml (½ pint) chicken stock**  
**salt and pepper to taste**  
**50g (2oz) Cheddar or Parmesan cheese, grated**

### Microwave Tip: Peeling garlic easily

Place 3-4 cloves of garlic on the turntable. Heat on HIGH for 30 seconds, squeeze at one end until clove pops out.

PREPARATION TIME - 12 MINUTES

- 1 Combine breadcrumbs and cheese.
- 2 Beat the egg on a plate. Dip each breast first into the egg and then into the breadcrumb mixture until thoroughly coated, place in a 2.5 litre (approx. 4 pint) casserole dish and put to one side.
- 3 Place flour in a bowl, mix to a paste with a little of the tomato juice. Stir in the rest of the tomatoes, garlic, oregano and chicken stock, salt and pepper, mix well. Heat on HIGH for 3-4 minutes, stirring every minute until thickened.
- 4 Spoon tomato mixture over the chicken breasts.
- 5 Place on the low rack, cook for 30 minutes on DUAL CONVECTION, 200°C, MEDIUM HIGH.
- 6 Rearrange the chicken pieces twice whilst cooking.
- 7 Sprinkle generously with grated cheese, 15 minutes before the end of cooking.

## HONEYED CHICKEN

SERVES 4

**4 chicken breasts**  
**30ml (2tbsp) clear honey (See Tip, opposite)**  
**5ml (1tsp) whole grain mustard**  
**2.5ml (½tsp) dried tarragon**  
**15ml (1tbsp) tomato purée**  
**150ml (¼ pint) chicken stock**  
**salt and pepper to taste**

PREPARATION TIME - 6 MINUTES

- 1 Place the chicken breasts in a casserole dish.
- 2 Mix all remaining ingredients together and pour over the chicken.
- 3 Cook on MEDIUM HIGH for 11-12 minutes. Coat the chicken with the sauce several times during cooking.

### Microwave Tip: Softening crystallised honey

Place 100g (4oz) honey in a bowl. Heat on HIGH for 1 minute until runny.

## CHICKEN, MASCARPONE & MUSHROOM GRATIN

SERVES 4

**4 chicken breasts, cut into 5cm pieces**  
**225g mushrooms, sliced**  
**2 leeks, sliced**  
**50g butter**  
**300g mushroom sauce as in cookbook (see page 58)**  
**250g mascarpone cheese**  
**grating of nutmeg**  
**salt and pepper to taste**  
**1-2 tsp wholegrain mustard**

PREPARATION TIME - 15 MINUTES

- 1 Place the chicken, leeks and mushrooms into a bowl with the butter and cook on HIGH for 7-8 minutes.
- 2 Make the mushroom sauce as page 59. Then mix the mascarpone cheese into the sauce.
- 3 Season the leeks, chicken and mushrooms with the nutmeg, salt, pepper and mustard. Stir.
- 4 Mix the sauce with the chicken mixture.
- 5 Place on the low rack and bake on DUAL CONVECTION for 15 minutes at 200°C MEDIUM. Stir halfway through the cooking time.

## VEGETABLE CHILLI

SERVES 4-6

30ml (2tbsp) olive oil  
 2 medium onions, chopped  
 2 cloves garlic, crushed (see Tip, page 47)  
 225g (8oz) small carrots, chopped  
 1 large red pepper, seeded and sliced  
 100g (4oz) mushrooms, cut into quarters  
 5ml (1tsp) ground cumin  
 5ml (1tsp) dried oregano  
 10ml (2tsp) mild chilli powder  
 2.5ml (1/2tsp) cayenne pepper  
 225g (8oz) canned tomatoes  
 75g (3oz) tomato purée  
 225g (8oz) canned haricot beans  
 225g (8oz) canned red kidney beans  
 1 bay leaf  
 300ml (1/2 pint) hot vegetable stock  
 salt and pepper to taste

PREPARATION TIME - 20 MINUTES

- 1 Place the oil, onion and garlic in a large bowl, heat on HIGH for 2 minutes.
- 2 Add the carrots, red pepper and mushrooms, mix well. Cook on HIGH for 3 minutes.
- 3 Stir in the remaining ingredients, mix well. Cook on MEDIUM HIGH for 24-25 minutes, stir 3-4 times during cooking.
- 4 Remove the bay leaf before serving.

*Serve hot with rice or as a filling for tacos.*

### Microwave Tip: Heating taco shells

Place 8-10 pre-cooked crisp taco shells on kitchen paper on the turntable. Heat on HIGH for 1 1/2-2 minutes until warm. Spoon in filling as preferred.

## RED LENTIL LASAGNE

SERVES 4-6

2tsp (10ml) olive oil  
 1 large onion, chopped  
 1 clove garlic, crushed  
 2 leeks, sliced  
 4oz mushrooms, thickly sliced  
 2tsp (10ml) chopped fresh basil  
 2tsp (10ml) chopped fresh oregano  
 225g (8oz) red split lentils  
 800g (28oz) canned chopped tomatoes  
 3/4 pint (450ml) vegetable stock  
 1 bay leaf  
 salt and pepper to taste  
 12 sheets lasagne (spinach)  
 1 pint (600ml) cheese sauce (see page 58)  
 50g cheddar cheese, grated

PREPARATION TIME - 20 MINUTES

- 1 Place the oil, onion and garlic in a bowl, cook for 2 minutes on HIGH.
- 2 Add the leeks, mushrooms, basil, oregano and lentils and then cook for a further 5 minutes on HIGH.
- 3 Stir in the tomatoes with the vegetable stock and the bay leaf.
- 4 Cover and cook for 20 minutes on MEDIUM HIGH.
- 5 Season with salt and pepper then remove the bay leaf.
- 6 Make the cheese sauce.
- 7 Put a layer of the lentil mixture into the base of a deep, 24cm (8") square dish. Cover with some lasagne and then some of the cheese sauce. Repeat, making the last layer cheese sauce, add the grated cheese.
- 8 Bake for 20 minutes DUAL CONVECTION, 200°C MEDIUM.

## STUFFED TOFU WITH SPICY TOMATO SAUCE

SERVES 4

450g (1lb) tofu, drained  
 60ml (4tbsp) olive oil  
 100g (4oz) Mozzarella, thinly sliced  
 75g (3oz) Danish Blue, thinly sliced  
 1 quantity Spicy Tomato Sauce (see page 58)

PREPARATION TIME - 12 MINUTES

- 1 Cut tofu in half to make 4 pieces.
- 2 Slice each piece horizontally along one side to make a pocket. Fill each pocket with sliced cheese, place in a large flan dish. Pour in sauce.
- 3 Place on turntable, cook on MEDIUM for 12-14 minutes.

## CHEESE & EGGS

### BLUE CHEESE & CHIVE JACKETS

SERVES 2

**2 baking potatoes (approx. 250g (9oz)) each**  
**50g (2oz) butter**  
**100g (4oz) blue cheese, finely chopped**  
**15ml (1tbsp) chives, chopped**  
**50g (2oz) mushrooms, finely chopped**  
**salt and pepper to taste**

**Variation:**

**Cheese & sweetcorn jackets:** Omit the blue cheese, chives and mushrooms. Add 100g (4oz) of grated Cheddar cheese and 50g (2oz) sweet corn kernels at Stage 2.

**Cook's Tip: Wooden skewers**

To remove food easily from wooden skewers, soak the skewers in water for 30 minutes prior to using them.

### PARTY PASTA

SERVES 4

**600g canned chopped tomatoes**  
**150g pesto (fresh)**  
**500g fresh ravioli (meat or asparagus etc)**  
**1pt cheese sauce (see page 58)**  
**120g mozzarella cheese**  
**40g parmesan**  
**25g fresh white breadcrumbs**  
**salt and pepper to taste**

### QUICHE LORRAINE

SERVES 4-6

**275g (10oz) short crust pastry**  
**6 rashers of bacon, chopped**  
**1 large onion, finely chopped**  
**4 eggs (size 3)**  
**300ml (1/2 pint) milk**  
**salt and pepper to taste**  
**5ml (1tsp) dried mixed herbs**  
**100g (4oz) Cheddar cheese, grated**

**Stilton & mushrooms:** Replace bacon with 125g (5oz) sliced mushrooms and Cheddar with Stilton.

PREPARATION TIME - 20 MINUTES

- 1 Prick each potato in several places. Place in a flan dish on low rack. Cook on DUAL GRILL, HIGH for 14-16 minutes until brown and crispy. Turnover after 7 minutes.
- 2 Halve each potato and scoop the flesh into a bowl, add the butter, cheese, chives and mushrooms, mix well. Season. Pile the mixture back into the potato skins.
- 3 Place the filled potatoes in a flan dish on the low rack. Cook on DUAL GRILL-1 (see page 12), MEDIUM for 7-8 minutes until brown and crispy.

**Microwave Tip: Drying herbs**

Place a handful of fresh herbs between two sheets of kitchen paper on the turntable. Heat on MEDIUM HIGH for 3 minutes until dry. Ensure the herbs do not become too dry. Woody herbs will take a little longer.

PREPARATION TIME - 15 MINUTES

- 1 Empty the tomatoes into a large bowl and cook for 8 minutes HIGH to reduce the tomato juice.
- 2 Then combine the tomatoes with the pesto sauce and season.
- 3 Spread a third of this sauce over the base of the buttered dish (24cm/8inch square), then place a single layer of ravioli. Next, spread a quarter of the cheese sauce over the ravioli. Layer until all ingredients have been used, with the last layer being ravioli. Now sprinkle the grated mozzarella all over and spread the remaining cheese sauce over the top.
- 4 Mix the parmesan and breadcrumbs together and sprinkle over the top. Place on the low rack and cook on DUAL CONVECTION, MEDIUM, 220°C for 25 minutes.

PREPARATION TIME - 18 MINUTES

- 1 Line a 20.4cm (8") flan dish with pastry.
- 2 Place bacon and onion in a bowl, cook on HIGH for 4 minutes.
- 3 Place eggs, milk, seasoning in a bowl, mix well.
- 4 Spread bacon and onion evenly over the pastry. Pour egg mixture over, top with grated cheese.
- 5 Place on the low rack, and cook on DUAL CONVECTION, 220°C MEDIUM LOW for 25 minutes until set and brown.

**Microwave Tip: Softening cream cheese**

Place 225g (8oz) cream cheese on a plate. Heat on MEDIUM LOW for 1 minute until soft.

## RICE & PASTA

### EGG FRIED RICE

SERVES 4

30ml (2tbsp) groundnut oil  
1 clove garlic, crushed (see Tip, page 47)  
4 spring onions, sliced  
100g (4oz) button mushrooms, halved  
50g (2oz) peas  
175g (6oz) long grain white rice, cooked  
15ml (1tbsp) dark soy sauce  
2 eggs (size 3), beaten  
salt and pepper to taste

PREPARATION TIME - 8 MINUTES

- 1 Place the oil, garlic, spring onions, mushrooms and peas in a large bowl, mix well. Heat on HIGH for 2 minutes.
- 2 Stir in the rice and soy sauce. Heat on HIGH for 6-7 minutes, stir every 2-3 minutes until the rice is evenly hot.
- 3 Pour egg over the rice, do not stir into the rice. Cook on HIGH for 2 minutes and then break up the egg and stir evenly into the rice. Season.

#### Microwave Tip: Cooking poppadums

Place 2-4 poppadums on the turntable leaving space between them. Heat on HIGH for 30 seconds to 1 minute until puffed and bubbly. Allow to stand for 10-20 seconds.

### BEEF RISOTTO

SERVES 4

30ml (2tbsp) olive oil  
1 medium onion, finely chopped  
1 stick celery, finely sliced  
1 green pepper, seeded and sliced  
1 red pepper, seeded and sliced  
175g (6oz) beef fillet, thinly sliced into 5cm (2") strips  
2.5ml (1/2tsp) cayenne pepper  
5ml (1tsp) ground cumin  
grated rind of 1 lemon  
75g (3oz) peas  
225g (8oz) white long grain rice  
600ml (1 pint) hot beef stock  
salt and pepper to taste

PREPARATION TIME - 12 MINUTES

- 1 Place the oil, onion, celery, red and green pepper in a large bowl, mix well. Heat on HIGH for 2 minutes. Stir in the beef and cook on HIGH for 5-6 minutes, stir halfway through cooking.
- 2 Stir in the remaining ingredients and cook on MEDIUM HIGH for 14-15 minutes until the rice is tender and all the beef stock has been absorbed, stir 2-3 times during cooking.

**Variation:** Make chicken risotto by substituting beef fillet for 225g (8oz) chicken breast fillet.

#### Microwave Tip: Softening avocados

Pierce an unpeeled avocado in several places. Place on the turntable and heat on HIGH for 1 minute. Allow to cool before peeling.

### FETTUCCINE CARBONARA

SERVES 4

225g (8oz) Fettuccine or other pasta  
600ml (1pint) boiling water  
225g (8oz) button mushrooms, halved  
4 shallots, finely sliced  
4 rashers bacon, chopped  
25g (1oz) butter  
300ml (1/2 pint) single cream  
1 egg (size 3), beaten  
15ml (1tbsp) fresh oregano, chopped  
100g (4oz) peas  
salt and pepper to taste

PREPARATION TIME - 10 MINUTES

- 1 Place the Fettuccine in a large bowl. Add the boiling water and cook on MEDIUM HIGH for 10-12 minutes until the pasta is tender, drain.
- 2 Place the mushrooms, shallots, bacon and butter in a bowl. Cook on HIGH for 3 minutes. Drain.
- 3 Beat the cream, egg and oregano together, add the mushroom mixture and peas. Season with salt and pepper to taste.
- 4 Pour over the cooked Fettuccine, toss gently, and heat on MEDIUM HIGH for 5 minutes, stir after 3 minutes.

## VEGETABLES

---

### VEGETABLE LOAF

---

SERVES 4-6

175g (6oz) fresh wholemeal breadcrumbs  
1 large carrot, grated  
2 small courgettes, sliced  
1 large potato, grated  
3 sticks of celery, sliced  
4 rashers bacon, chopped (optional)  
125g (5oz) Cheddar cheese, grated  
2 eggs (size 3), beaten  
salt and pepper to taste  
75g (3oz) Cheddar cheese, grated to sprinkle  
15ml (1tbsp) fresh parsley, chopped

---

PREPARATION TIME - 20 MINUTES

- 1 Combine breadcrumbs, carrot, courgette, potato and celery. Add bacon (if using), cheese, eggs, salt and pepper, mix well.
- 2 Pour mixture into a greased 1.5 litre (2.5 pint) loaf dish, cover with the cheese and parsley.
- 3 Place on turntable, use sequence programming to cook on MEDIUM for 17 minutes, then on DUAL GRILL-1, MEDIUM for 7 minutes.

**NOTE:** For information on using the DUAL GRILL see page 12 of the operation manual

### VEGETABLE LAYER

---

SERVES 4

450g (1lb) celeriac/courgettes  
350g (12oz) carrots  
350g (12oz) potatoes  
75g (3oz) butter, melted  
225g (8oz) mature cheddar cheese, grated  
salt and pepper to taste

---

PREPARATION TIME - 15 MINUTES

- 1 Wash and peel all vegetables.
- 2 Rinse the potatoes thoroughly and dry well on kitchen paper.
- 3 Roughly grate them, placing into separate bowls. Season.
- 4 Layer the vegetables and cheese in a 1.5 litre (2.5 pint) casserole dish alternately, then arrange the rest of the potatoe on top of these layers and finish off with a sprinkling of cheese.
- 5 Bake on DUAL CONVECTION 200°C MEDIUM, for 25 minutes.

### STIR FRIED VEGETABLES

---

SERVES 4

15ml (1tbsp) sunflower oil  
30ml (2tbsp) soy sauce  
15ml (1tbsp) sherry  
2.5cm (1") root ginger, peeled and finely grated  
1 clove garlic, crushed (see Tip, page 47)  
2 medium carrots, cut into fine strips  
100g (4oz) button mushrooms, halved  
50g (2oz) beansprouts  
100g (4oz) mange-tout  
1 red pepper, seeded and thinly sliced  
4 spring onions, chopped  
100g (4oz) canned water chestnuts, sliced  
half a head of chinese leaves, thinly sliced

---

PREPARATION TIME - 12 MINUTES

- 1 Place the oil, soy sauce, sherry, ginger, garlic and carrots in a large bowl and mix well. Cover and cook on HIGH for 4-5 minutes.
- 2 Stir in the mushrooms, beansprouts, mange-tout, red pepper, spring onions, water chestnuts and chinese leaves. Cook on HIGH for 5-6 minutes until the vegetables are tender, stir halfway through cooking.

## CHERRY CHEESECAKE

SERVES 8

75g (3oz) butter  
 175g (6oz) biscuits - sweet, finely crushed  
 450g (1lb) cream cheese  
 100g (4oz) caster sugar  
 3 eggs, beaten  
 2tsp (10ml) vanilla essence  
 150ml (1/4 pint) soured cream  
 3tbsp (45ml) clear honey  
 1 large can of cherry pie filling  
 150ml (1/4 pint) double cream

PREPARATION TIME - 15 MINUTES

- 1 Put the butter in a bowl and heat on HIGH for 1 minute. Add the biscuit crumbs and stir. Cook on HIGH for 1 minute.
- 2 Press the crumbs into the base and sides of a 25 cm, 10" flan dish.
- 3 Beat the cream cheese, sugar, eggs and vanilla essence together. Pour the filling on top of the biscuit flan case. Cook on DUAL CONVECTION 180°C, LOW for 25 minutes until the centre is almost set.
- 4 Stir the soured cream into the honey, then pour over the top of the cheesecake. Cook on full power HIGH for 1 minute. Allow to cool, then chill in the refrigerator for 1 hour.
- 5 Pile the cherry filling on top of the cake and decorate the edges with rosettes of whipped cream.

## APPLE PIE

SERVES 6

100g (4oz) butter  
 225g (8oz) flour  
 25g (1oz) water  
 1 egg yolk (size 3)  
 cold water to mix  
**Filling:**  
 1kg (2lb) cooking apples, peeled & sliced  
 100g (4oz) demerara sugar  
 10ml (2tsp) ground cinnamon (optional)  
 grated rind of 1 orange (optional)  
 1 egg (size 3) mixed with a little milk to glaze  
 demerara sugar

PREPARATION TIME - 25 MINUTES

- 1 For pastry, rub butter into flour until mixture resembles breadcrumbs. Stir in sugar and bind with egg yolk. Add enough cold water to make a soft but not sticky dough. Chill whilst making the filling.
- 2 For filling, combine apple, sugar, cinnamon (if using) and orange rind (if using) in a large bowl. Cook on HIGH for 8 minutes, stirring twice.
- 3 Line the base of a greased, 20.4 x 2.5cm (8x1") pie dish with half the pastry. Cook the pastry base on MEDIUM for 7-8 minutes. Spoon in apple mixture, roll out remaining pastry and cover.
- 4 Pinch pastry edges to seal and make a slit in the centre with a sharp knife. Brush with egg mixture to glaze and sprinkle generously with sugar.
- 5 Place on the low rack, cook on DUAL CONVECTION, 220°C MEDIUM LOW for 20 minutes. .

## RASPBERRY & CHOCOLATE CAKE

SERVES 8

100g (4oz) white chocolate, chopped  
 250g (8oz) self raising flour  
 Large pinch of salt  
 175g (6oz) butter, cut into small pieces  
 50g (2oz) ground almonds  
 100g (4oz) caster sugar  
 2 eggs, at room temperature  
 4 tbsp milk  
 1 tsp vanilla essence  
 300g (10oz) fresh raspberries  
 Icing sugar, for dusting

PREPARATION TIME - 15 MINUTES

- 1 Grease a 20cm/8" round cake tin and line the base with greaseproof paper.
- 2 Sift the flour and salt into a large bowl. Rub the butter into the flour until the mixture resembles breadcrumbs. Stir in the ground almonds and sugar.
- 3 Beat the eggs, milk and the vanilla essence together and mix into the flour mixture. Add the chocolate and raspberries and mix in gently.
- 4 Spread the mixture into the cake tin and place on the low rack and cook on DUAL COOK 180°C, MEDIUM for 30 minutes. Allow the cake to cool. Dust with icing sugar.



## FIGGY PUDDING

SERVES 6

125g (5oz) dried figs, roughly chopped  
 125g (5oz) dried apricots, roughly chopped  
 100g (4oz) raisins  
 100g (4oz) currants  
 60ml (4tbsp) brandy  
 75g (3oz) plain flour  
 2.5ml (1/2tsp) allspice  
 2.5ml (1/2tsp) grated nutmeg  
 2.5ml (1/2tsp) ground cinnamon  
 50g (2oz) fresh breadcrumbs  
 75g (3oz) shredded suet  
 100g (4oz) soft brown sugar  
 50g (2oz) blanched almonds, roughly chopped  
 grated rind of 1 medium orange  
 grated rind of 1 medium lemon  
 1 eating apple, grated  
 15ml (1tbsp) black treacle  
 1 egg (size 3), beaten

PREPARATION TIME - 2 1/4 HOURS

- 1 Place figs, apricots, raisins, currants, and brandy in a large bowl, mix well. Leave for 2 hours.
- 2 Place the flour, spices, breadcrumbs, suet, sugar, almonds, orange and lemon rind and apple in a bowl, mix well. Stir into the dried fruit mixture along with the treacle and beaten egg.
- 3 Grease 1.2 litre (2 pint) pudding basin and line the base with a circle of kitchen paper. Spoon in the pudding mixture, smooth the surface and cover with cling film.
- 4 Cook on MEDIUM for 16-17 minutes until firm to the touch.

Serve with brandy sauce, see page 56.

### Microwave Tip: Reheating Christmas pudding

Place a 500g (1lb 2oz) pudding in a shallow flan dish. Cover and heat on MEDIUM HIGH for 3-4 minutes.

## CHOCOLATE FUDGE

MAKES 675g (1 1/2LB)

100g (4oz) milk chocolate, broken into pieces  
 100g (4oz) butter, melted  
 450g (1lb) icing sugar  
 45ml (3tbsp) milk

PREPARATION TIME - 6 MINUTES

- 1 Place the chocolate in a bowl and heat on HIGH for 2 minutes, stir every 30 seconds until melted.
- 2 Stir in butter, icing sugar and milk. Heat on HIGH for 3 minutes, stir vigorously every minute until the mixture is thick and glossy.
- 3 Pour into a greased, rectangular 20.4 x 15.3cm (8 x 6") dish, chill to set before cutting.

## TREACLE TOFFEE

MAKES 300g (10oz)

225g (8oz) soft dark brown sugar  
 75ml (5tbsp) water  
 5ml (1tsp) treacle  
 25g (1oz) butter  
 30ml (2tbsp) malt vinegar

PREPARATION TIME - 4 MINUTES

- 1 Place all ingredients in a bowl, mix well. Heat on MEDIUM HIGH for 14 minutes, stir every 2-3 minutes until toffee reaches hard crack\* stage. (See tip below).
- 2 Pour into a greased, square 15.3cm (6") dish. Chill to set before breaking.

\***Hard crack:** To determine drop a teaspoon of mixture into a glass of cold water and the toffee should be hard to the touch.

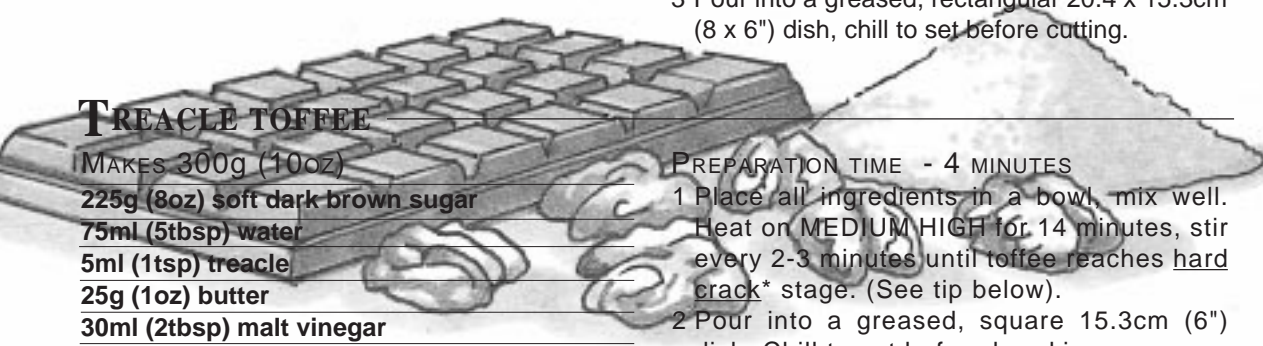

### MOIST CARROT CAKE

---

SERVES 6-8

**150ml (1/4 pint) sunflower oil**  
**225g (8oz) soft brown sugar**  
**3 eggs (size 3), beaten**  
**175g (6oz) self raising flour**  
**5ml (1tsp) bicarbonate of soda**  
**1.25 ml (1/4tsp) salt**  
**10ml (2tsp) cinnamon**  
**2 large carrots, grated**  
**100g (4oz) walnut halves, roughly chopped**  
**icing:**  
**225g (8oz) cream cheese (See Tip, page 46)**  
**grated rind of 1 lemon**  
**5ml (1tsp) lemon juice (See Tip, page 42)**  
**30ml (2 tbsp) icing sugar**  
**25g (1oz) walnuts, finely chopped to sprinkle**

PREPARATION TIME - 15 MINUTES

- 1 Combine the oil, sugar and eggs. Fold in the flour, bicarbonate of soda, salt and cinnamon. Add the carrots and walnuts, mix well.
- 2 Grease and line a 20.4cm (8") soufflé dish with greaseproof paper, pour in the cake mixture.
- 3 Place on turntable, cook for 17 minutes on MEDIUM until a skewer comes out clean. Allow to cool before decorating.
- 4 To prepare icing, combine cream cheese, lemon rind, lemon juice and icing sugar until smooth. Spread on top of the cake, sprinkle with walnuts.

If iced with cream cheese, keep cake refrigerated. Eat within 2 days.

### CHOCOLATE BROWNIES

---

SERVES 6-8

**225g (8oz) margarine**  
**225g (8oz) caster sugar**  
**7.5ml (1 1/2tsp) vanilla essence**  
**4 eggs (size 3), beaten**  
**100g (4oz) plain flour**  
**50g (2oz) cocoa powder**  
**2.5ml (1/2tsp) baking powder**  
**75g (3oz) walnuts, roughly chopped**

PREPARATION TIME - 10 MINUTES

- 1 Combine the margarine, sugar, vanilla essence and eggs together until smooth.
- 2 Stir in the remaining ingredients.
- 3 Grease and line the base of a deep, square 20.4cm (8") dish with greaseproof paper, spoon in the brownie mixture and smooth the surface.
- 4 Place on the low rack, cook for 17 minutes at 180°C, MEDIUM.

### VICTORIA SANDWICH CAKE

---

SERVES 4-6

**175g (6oz) margarine**  
**175g (6oz) caster sugar**  
**3 eggs (size 3), beaten**  
**175g (6oz) self raising flour**  
**45ml (3tbsp) strawberry jam**  
**25g (1oz) icing sugar to dredge**

**Variation:**

**Butterfly buns:** Place 10ml (2tsp) of cake mixture into 20 bun cases in bun trays. Bake for 23-24 minutes at 130°C, cook until firm, repeat for other trays. When cool, scoop a teaspoon of sponge from the centre of each bun, fill the hollow with buttercream. Cut each teaspoonful of sponge in half and position the "wings" in the buttercream.

PREPARATION TIME - 8 MINUTES (2 LAYER)

- 1 Grease and line the base of two 17.8cm (7") sandwich tins with greaseproof paper.
- 2 Cream the margarine and sugar until light and fluffy, beat in the eggs. Fold in the flour.
- 3 Spoon equal amounts of the cake mixture into the prepared tins.
- 4 Place one tin on the low rack and the other on the high rack. Bake in the preheated oven CONVECTION 180°C for 25 minutes, after 15 minutes change the two cakes around and continue cooking until evenly golden and firm to the touch. Allow to cool before turning out.
- 5 Sandwich with jam and dredge with icing sugar.



## CAKES & BISCUITS

---

### PLAIN MICROWAVE CAKE

---

SERVES 4-6

**100g (4oz) margarine**

**100g (4oz) caster sugar**

**2 eggs (size 3), beaten**

**100g (4oz) self raising flour**

**30-45ml (2-3tbsp) water**

PREPARATION TIME - 8 MINUTES

- 1 Cream margarine and sugar, beat in the eggs. Fold in the flour and water. Grease and line the base of a 17.8cm (7") cake dish with kitchen paper. Spoon mixture into dish and smooth.
- 2 Cook on HIGH for 4-5 minutes until firm. Allow to cool slightly before turning out.

### CHOCOLATE CHIP COOKIES

---

SERVES 6-8

**175g (6oz) margarine**

**100g (4oz) caster sugar**

**225g (8oz) self raising flour**

**50g (2oz) milk chocolate, finely chopped**

**25g (1oz) walnuts, finely chopped**

*The biscuits will be soft when hot but will harden as they cool.*

PREPARATION TIME - 10 MINUTES

- 1 Cream margarine and sugar until light and fluffy. Stir in the flour, chocolate and walnuts to make a soft but firm dough.
- 2 Divide mixture into 8 even sized balls, place apart in two large flan dishes and flatten slightly.
- 3 Place one flan dish on the low rack, cook for 27 minutes, at 130°C until evenly brown. Repeat for remaining biscuits.
- 4 Allow to cool before removing from the dish.



### CHERRY AND ALMOND CAKE

---

SERVES 6

**175g (6oz) butter**

**175g (6 oz) caster sugar**

**3 eggs (size 3)**

**175g (6oz) plain flour**

**5ml (1tsp) baking powder**

**100g (4oz) glacé cherries, quartered**

**75g (3oz) ground almonds**

**5ml (1tsp) almond essence**

**15ml (1tbsp) milk**

PREPARATION TIME - 12 MINUTES

- 1 Cream the butter and sugar together until light and fluffy, beat in the eggs.
- 2 Fold in flour and baking powder, stir in the cherries, ground almonds, almond essence and milk.
- 3 Grease and line the base of a 17.8cm (7") cake dish with greaseproof paper. Spoon in the cake mixture and smooth the surface.
- 4 Place on the low rack, bake on DUAL CONVECTION, 200°C, MEDIUM LOW for 17 minutes until golden and a skewer comes out cleanly.

## BREAD & SCONES

---

### POTATO BREAD

---

SERVES 4

**275g (10oz) potato, cooked and mashed**  
**275g (10oz) self raising flour**  
**100g (4oz) mature Cheddar cheese, grated**  
**5ml (1tsp) salt**  
**5ml (1tsp) mixed dried herbs**  
**2 cloves garlic, crushed (see Tip, Page 47)**  
**10ml (2tsp) whole grain mustard**  
**1 egg (size 3), beaten**  
**75ml (5tbsp) milk**  
**1 egg (size 3), beaten to glaze**  
**5ml (1tsp) fresh parsley, chopped to sprinkle**

PREPARATION TIME - 15 MINUTES

- 1 Place the potato, flour, cheese, salt, herbs, garlic and mustard in a large bowl, mix well.
- 2 Add the egg and milk, mix to form a soft dough. Knead the dough into a round shape approx. 20.4cm (8") in diameter. Place in a 25.4cm (10") flan dish, brush with egg to glaze, sprinkle with parsley.
- 3 Place on the low rack, use sequence programming to cook on MEDIUM for 8 minutes, then on DUAL GRILL-1 (see page 12), MEDIUM for 8 minutes until golden.

*Serve with soup, cheese or salad.*

### DATE & WALNUT BREAD

---

SERVES 6-8

**175g (6oz) dates, chopped**  
**150ml (1/4 pint) boiling water**  
**225g (8oz) plain flour**  
**125g (5oz) wholemeal flour**  
**125g (5oz) caster sugar**  
**2.5ml (1/2tsp) salt**  
**2.5ml (1/2tsp) bicarbonate of soda**  
**100g (4oz) butter**  
**125g (5oz) walnuts, roughly chopped**  
**150ml (1/4 pint) milk**  
**1 egg (size 3), beaten**

PREPARATION TIME - 15 MINUTES

- 1 Place dates in a large bowl, add the boiling water, leave aside to cool.
- 2 Place flours, sugar, salt and bicarbonate of soda in a bowl, mix well. Rub in butter until mixture resembles fine breadcrumbs, stir in walnuts.
- 3 Add the date mixture, milk and egg, mix well.
- 4 Grease and line the base of a 1.5 litre (2 1/2 pint), straight-sided loaf dish with greaseproof paper. Spoon in loaf mixture and smooth the surface.
- 5 Place on the turntable, cook for 20 minutes at 130°C.

*Serve sliced, spread generously with butter.*

### SODA BREAD

---

SERVES 4

**175g (6oz) wholemeal self raising flour**  
**100g (4oz) medium oatmeal**  
**2.5ml (1/2 tsp) salt**  
**5ml (1tsp) bicarbonate of soda**  
**25g (1oz) butter**  
**120 ml (4flop) natural yoghurt**  
**90ml (6tbsp) milk**  
**1 egg (size 3), beaten to glaze**  
**sesame seeds to sprinkle**

PREPARATION TIME - 15 MINUTES

- 1 Combine flour, oatmeal, salt, bicarbonate of soda in a large bowl. Rub in the butter.
- 2 Add the yoghurt and milk, mix to form a soft but not sticky dough.
- 3 Knead lightly into a round shape approx. 20cm (8") in diameter. Place in a greased 25cm (10") flan dish.
- 4 Use a knife to mark into 8 wedges, cut only halfway through the dough. Glaze surface with egg, sprinkle with sesame seeds.
- 5 Place on low rack, bake in a preheated oven on DUAL CONVECTION, 200°C, LOW for 17-18 minutes until golden.

*Serve with cheese and a salad.*

## DANISH TEA RING

SERVES 6-8

- 250g (9oz) strong plain flour
- 5ml (1tsp) dried yeast
- 5ml (1tsp) caster sugar
- 5ml (1tsp) salt
- 25g (1oz) butter
- 1 egg (size 3), beaten
- 120ml (4floz) hand hot milk
- 25g (1oz) butter, melted
- filling:
- 100g (4oz) ground almonds
- 100g (4oz) caster sugar
- 2.5ml (1/2tsp) almond essence
- 2 egg whites (size 3)
- topping:
- 175g (6oz) icing sugar
- 10ml (2tsp) lemon juice
- 10ml (2tsp) water
- flaked almonds, to sprinkle
- glacé cherries, halved, to sprinkle

PREPARATION TIME - 25 MINUTES

- 1 Place flour, yeast, sugar and salt in a bowl, mix well. Rub in butter. Add egg and milk, mix to a soft dough. Knead lightly. Return to the bowl, cover with cling film.
- 2 Place on low rack, prove on CONVECTION 40°C for 20 minutes.
- 3 Roll the dough into a rectangle 20.4 x 38cm (8 x 14"), brush with melted butter.
- 4 To prepare filling, mix ground almonds, sugar, essence and egg whites to a paste. Spread over the dough, roll up tightly from longest side.
- 5 Place roll in a large, greased flan dish, join ends to form a ring. Using scissors snip 1cm (1/2") into the dough along the length of the ring at 2cm (3/4") intervals. Cover loosely with cling film.
- 6 Place on turntable, prove on CONVECTION 40°C for 20 minutes. Remove cover.
- 7 Place on low rack, bake in a preheated oven CONVECTION 220°C for 15-20 minutes until golden brown before decorating.
- 8 To prepare topping, mix icing sugar, lemon juice and water until smooth. Spread evenly over tea ring, sprinkle with flaked almonds and cherries.

## FRUIT SCONES

SERVES 6-8

- 225g (8oz) self raising flour
- 50g (2oz) caster sugar
- 50g (2oz) butter
- 50g (2oz) sultanas
- 1 egg (size 3), beaten with milk to make 50ml (1/4 pint)
- 1 egg (size 3), beaten to glaze

**Variations:**

**Wholemeal scones:** Substitute white self raising flour with wholemeal self raising flour, omit sultanas.

**Date scones:** Substitute white self raising flour with wholemeal self raising flour and the sultanas with 50g (2oz) dates, finely chopped.

**Spiced apple scones:** Substitute white self raising flour with wholemeal flour and sultanas with 1 eating apple, grated. Add 5ml (1tsp) cinnamon at Stage 2.

**Cheese and chive scones:** Omit sugar and sultanas. Add 100g (4oz) grated Cheddar cheese, 15ml (1tbsp) dried chives, salt and pepper at Stage 2.

**Fresh herb scones:** Omit sugar and sultanas. Add 5ml (1tsp) fresh parsley, 5ml (1tsp) fresh sage and 5ml (1tsp) fresh thyme at Stage 2.

PREPARATION TIME - 15 MINUTES (2-LAYER)

- 1 Grease two large flan dishes.
- 2 Combine the flour and sugar in a bowl, rub in the butter and stir in the fruit. Add enough egg and milk mixture to form a soft dough.
- 3 Roll out until 2cm (3/4") thick, cut out scones 6.4cm (2 1/2") in diameter.
- 4 Place the scones in the prepared dishes and brush with egg to glaze.
- 5 Place one dish on the low rack and the other on the high rack. Cook for 25 minutes at 200°C until golden, changing the two dishes around after 15 minutes.

**Microwave Tip: Drying breadcrumbs**

Spread 100g (4oz) fresh breadcrumbs evenly over a large plate. Heat on HIGH for 2-3 minutes, stir every minute until crispy.

## SAUCES

---

### WHITE SAUCE

---

MAKES 300ML (1/2 PINT)

25g (1oz) butter

25g (1oz) plain flour

300ml (1/2 pint) milk

salt and pepper to taste

#### Variations:

**Cheese sauce:** Add 75g (3oz) grated cheese and 5ml (1tsp) mustard powder at Stage 2. Serve with vegetables, fish, meat.

**Parsley sauce:** Stir 15-30ml (1-2tbsp) chopped parsley into the finished sauce. Serve with fish.

**Onion sauce:** Stir 1 large cooked onion, finely chopped, into finished sauce. Heat on HIGH for 1 minute. Serve with meat or vegetables.

PREPARATION TIME - 4 MINUTES

- 1 Place the butter in a bowl, heat on HIGH for 1 minute until melted.
- 2 Stir in the flour and whisk in the milk. Cook on HIGH for 6 minutes, stir every 2 minutes until thick and smooth. Season with salt and pepper

**Mushroom sauce:** Add 2 sliced spring onions, 50g (2oz) chopped mushrooms and 5ml (1tsp) chopped parsley at the beginning of Stage 2. Serve with fish.

**Sweet white sauce:** Omit salt and pepper from the basic recipe. Add 50g (2oz) caster sugar at Stage 2. Serve with puddings as an alternative to custard.

### BECHAMEL SAUCE

---

MAKES 300ML (1/2 PINT)

300ml (1/2 pint) milk

1 small onion, sliced

1 small carrot, sliced

1/2 stick of celery, sliced

2 whole cloves

6 white peppercorns

25g (1oz) butter

25g (1oz) plain flour

salt and pepper to taste

PREPARATION TIME - 8 MINUTES

- 1 Place the milk, onion, carrot, celery, cloves and peppercorns in a bowl. Heat on MEDIUM for 4 minutes. Cover and leave to infuse for 35 minutes (optional). Strain and reserve the liquid.
- 2 Heat butter on HIGH for 1 minute until melted. Stir in flour and gradually add the strained milk.
- 3 Heat on HIGH for 6 minutes, whisking every 2 minutes. Season with salt and pepper to taste.

Serve with vegetables, meat or fish.

### SPICY TOMATO SAUCE

---

MAKES 600ML (1 PINT)

8 large tomatoes, chopped

1 large onion, chopped

2 cloves garlic, crushed (see Tip, page 47)

300ml (1/2 pint) red wine

2.5ml (1/2tsp) chilli powder

15ml (1tbsp) whole grain mustard

30ml (2tbsp) tomato paste

PREPARATION TIME - 8 MINUTES

- 1 Combine all ingredients in a large bowl. Cook on HIGH for 24 minutes, stir every 5-6 minutes.
- 2 Blend in a food processor until smooth.

Serve with chicken, pasta or stuffed tofu, see page 48.

### MUSTARD SAUCE

---

MAKES 300ML (1/2 PINT)

25g (1oz) butter

45ml (3tbsp) whole grain mustard

200ml (7floc) soured cream

salt and pepper to taste

15ml (1tbsp) fresh parsley, chopped

PREPARATION TIME - 5 MINUTES

- 1 Place butter in a bowl, heat on HIGH for 30 seconds. Add the mustard, soured cream, salt, pepper and parsley, mix well.
- 2 Cook on HIGH for 4 minutes, stir every minute, until smooth and thick.

Serve with meat or fish.

### BLUE CHEESE SAUCE

---

MAKES 150ML (1/4 PINT)

**75g (3oz) Danish Blue cheese, finely chopped**

**45ml (3tbsp) soured cream**

**30ml (2tbsp) fresh parsley, chopped**

**salt and pepper to taste**

PREPARATION TIME - 5 MINUTES

- 1 Place the cheese, soured cream and parsley in a bowl, mix well. Season.
- 2 Heat on HIGH for 3 minutes.

### BRANDY SAUCE

---

MAKES 600ML (1 PINT)

**50g (2oz) butter**

**50g (2oz) plain flour**

**75g (3oz) brown sugar**

**15ml (1tbsp) golden syrup**

**150ml (1/4 pint) double cream**

**300ml (1/2 pint) milk**

**60ml (4tbsp) brandy to taste**

PREPARATION TIME - 8 MINUTES

- 1 Place butter in a bowl, heat on HIGH for 1 minute until melted. Stir in flour, heat on HIGH for 1 minute.
- 2 Combine sugar, syrup, cream and milk, heat on HIGH for 2 minutes.
- 3 Gradually add cream mixture to the butter and flour mixture. Heat on HIGH for 5-6 minutes, stir every minute until smooth and thick. Stir in brandy.

*Serve hot with Figgy Pudding (page 53).*

### STRAWBERRY JAM

---

MAKES 675g (1 1/2LB)

**675g (1 1/2lb) strawberries, washed and hulled**

**45ml (3tbsp) lemon juice (see Tip, page 42)**

**675g (1 1/2lb) caster sugar**

PREPARATION TIME - 15 MINUTES

- 1 Place strawberries and lemon juice in a very large bowl.
- 2 Heat on HIGH for 5 minutes until strawberries have softened. Add the sugar, mix well.
- 3 Cook on MEDIUM HIGH for 25-30 minutes until setting point\* is reached, stir every 4-5 minutes.
- 4 Pour into hot, clean jars. Cover, seal and label.

### LEMON CURD

---

MAKES 300g (12oz)

**100g (4oz) butter**

**225g (8oz) caster sugar**

**15ml (1tbsp) cornflour**

**juice of 3 medium lemons (see Tip, page 42)**

**grated rind of 2 lemons**

**4 egg yolks (size 3), beaten**

PREPARATION TIME - 8 MINUTES

- 1 Place butter and sugar in a bowl. Heat on HIGH for 2 minutes until melted.
- 2 Mix cornflour, lemon juice and rind. Stir into the butter and sugar mixture. Heat on HIGH for 2 minutes until sugar has dissolved. Cool slightly.
- 3 Beat in the egg yolks, cook on MEDIUM for 10-12 minutes, stir every 2 minutes until thickened.
- 4 Pour into hot, clean jars. Cover, seal and label.





## CLEANING & MAINTENANCE

### OVEN INTERIOR

**Clean the microwave oven cavity, after each use with a mild detergent solution on a soft cloth, pay special attention to the waveguide cover.**

Take care not to let soapy water drip through the small holes in the oven walls and the cavity floor particularly if the turntable and turntable support are removed.

Excess water spillage through these holes will cause damage to the oven interior. It is important that the door seals and sealing surfaces are kept clean at all times, wipe regularly with a damp cloth.

Heat up your oven regularly by using both grill elements, refer to page 11.

Remaining food or fat splashed on the oven interior can cause smoke or a bad smell.

To prevent splashing, cover food wherever possible.

### ACCESSORIES

Accessories should be washed in a mild washing-up liquid solution and dried. They are dishwasher safe.

### OUTER CABINET

Wipe the outside cabinet with a mild detergent solution on a soft cloth. The control panel must be wiped clean whilst the door is open, therefore deactivating the oven.

### ⚠ WARNINGS-

- **Do not allow grease or dirt to build up on the door seals and adjacent parts as this may prevent the door from closing correctly and may cause a leakage of microwaves. To clean use a mild detergent solution on a soft damp cloth.**
- Keep the waveguide cover clean at all times. If you leave grease or fat in the cavity, it may overheat, smoke or even catch fire when next using the oven. Do not remove the waveguide cover.
- Never use spray cleaners, oven pads or abrasive scourers as these damage the surface of the oven.
- After Grill, Convection, Dual, Pizza, Breakfast, Instant Cook and Auto Cook modes, the oven cavity, door, oven cabinet and accessories will become very hot. Before cleaning, make sure they have cooled down.
- **Cleaning Bottom Grill**  
The grill element moves upwards enabling the bottom of the cavity to be wiped clean. Ensure it is cold before cleaning. After cleaning, gently push the bottom grill down to its lowest position (See the diagram below and on page 2).

**NOTE:** When cleaning oven please ensure that bottom grill is cool.

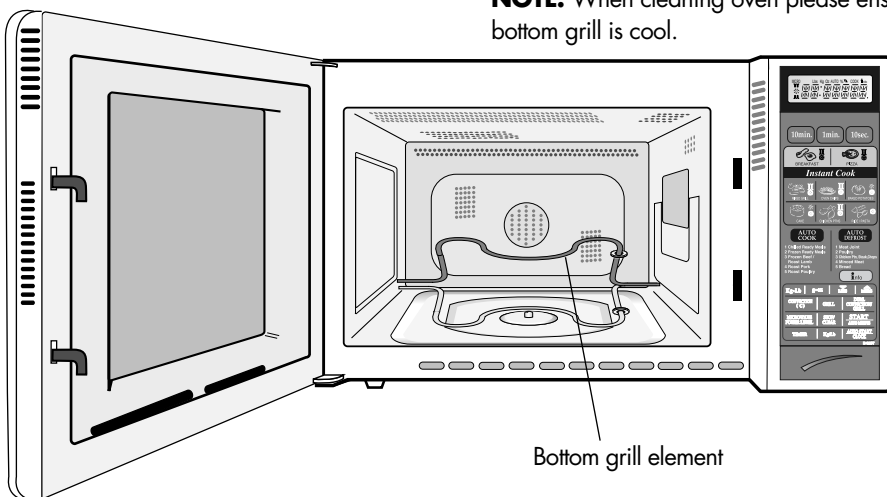



If you think the oven is not working properly there are some simple checks you can carry out yourself before calling an engineer. This will help prevent unnecessary service calls if the fault is something simple.

Simply answer "YES" or "NO" to the following questions:

- 1.** Does the oven lamp come on when you open the door? YES/NO

(Put half a cup of water in the oven, on the turntable and close the door. Select HIGH (100%) and programme the oven to cook for 1 minute.)

- 2.** Does the oven lamp come on? YES/NO

- 3.** Does the turntable rotate? YES/NO

- 4.** Does the cooling fan work? (Check by placing your hand above the air-vent openings) YES/NO

- 5.** After 1 minute does the "beep" sound? YES/NO

- 6.** Is the water in the cup hot? YES/NO

(Take the cup out of the oven and close the door. Set the grill time for the top and bottom grill for 3 minutes.)

- 7.** At the end of 3 minutes do both the grill elements become red? YES/NO

(Programme the oven on convection 180°C for 3 minutes.)

- 8.** Does the oven lamp come on? YES/NO

- 9.** Does the turntable rotate? YES/NO

- 10.** After 3 minutes is the oven cavity hot? YES/NO

If you answer "NO" to any question first check that the oven is plugged in properly and the fuse has not blown, if there is no fault with either, check the troubleshooting chart on page 62.

## NOTES:

The following cooking conditions should not cause concern:

- If you cook food for more than the standard time (see chart opposite) at the same power level, the oven's safety mechanisms will automatically activate. The microwave power level will be reduced and the grill heating elements will turn on and off.

- After Grill (using both grill heaters), Dual Cooking, Convection, Pizza, Breakfast, Instant Cook and Auto Cook modes, the cooling fan will switch on for cooling the oven cavity. When the cooling fan works,

will be displayed.

During these modes, the cooling fan will also work when you press **STOP/CLEAR**. You may feel air blowing out of the air-vent openings.

## ⚠ WARNINGS:

- It is hazardous for anyone other than a competent person to carry out any service or repair operation which involves the removal of a cover which gives protection against exposure to microwave energy.**
- The door seal stops microwave leakage during oven operation, but does not form an airtight seal. It is normal to see drops of water, light or feel warm air around the oven door. Food with a high moisture content will release steam and cause condensation inside the door which may drip from the oven.
- Repairs & Modifications: Do not attempt to operate the oven if it is not working properly.
- Outer Cabinet & Lamp Access: Never remove the outer cabinet. This would be very dangerous due to high voltage parts inside which must never be touched, as this could be fatal. As your oven is not fitted with a lamp access cover, if the lamp fails, do not attempt to replace the lamp yourself, call a Service Technician appointed by SHARP.

COOKING MODE	STANDARD TIME
<b>Microwave 100% cooking</b>	20 MINUTES
<b>Grill cooking</b>	
Top grill	30 MINUTES
Bottom grill	45 MINUTES
Top and bottom grills	UPPER GRILL 15 MINUTES BOTTOM GRILL 15 MINUTES
<b>Dual cooking</b>	
Micro and top grill	MICROWAVE 20 MINUTES TOP GRILL 15 MINUTES
Micro and bottom grill	MICROWAVE 20 MINUTES BOTTOM GRILL 15 MINUTES



## TROUBLESHOOTING (Continued)

PROBLEM	POSSIBLE CAUSE
Draught circulates around the door.	When oven is working, air circulates within the cavity. The door does not form an airtight seal, so it is normal for air to escape from the door.
Condensation forms in the oven, and may drip from the door.	The oven cavity will normally be colder than the food being cooked, and so steam produced when cooking will condense on the colder surface. The amount of steam produced depends on the water content of the food being cooked. Some foods, such as potatoes have a high moisture content. Condensation trapped in the door glass should clear after a few hours.
Flashing or arcing from within the cavity when cooking.	Arcing will occur when a metallic object comes into close proximity to the oven cavity during cooking. This may possibly roughen the surface of the cavity, but would not otherwise damage the oven.
Arcing potatoes.	Ensure all "eyes" are removed and stand directly onto the turntable or in a heat resistant flan dish or similar.
After setting the time, the oven does not start.	Check the door is closed properly.
Oven cooks too slowly.	Ensure correct power level has been selected.
Oven makes a noise.	The microwave energy pulses ON/OFF during cooking/defrosting.
Outer cabinet/door is hot.	The cabinet may become hot to the touch - keep children away.



## TO REPLACE THE MAINS PLUG

The wires in the mains cable are colour coded as shown opposite:

green and yellow stripes = **EARTH**  
 blue = **NEUTRAL**  
 brown = **LIVE**

As the colours of the cores in the mains lead of your oven may not correspond with the coloured marking identifying the terminals in your plug, connect the wires as shown opposite.

Make sure the terminal screws are tight and the cable is held securely by the cable grip where it enters the plug. Like most appliances in your home, your oven must be connected to a single phase 230/240 Volt, 50Hz alternating current supply.

If you do not make the proper electrical connections you might damage the oven or injure yourself. Neither SHARP nor the supplier will be liable if this happens.

- The green and yellow wire to the plug terminal marked E or  $\equiv$  or coloured green or coloured green and yellow.
- The blue wire to the plug terminal marked N or coloured black or coloured blue.
- The brown wire to the plug terminal marked L or coloured red or coloured brown.



### **WARNING!**

**THIS APPLIANCE MUST BE EARTHED.  
 IF YOU HAVE ANY DOUBTS ABOUT YOUR  
 ELECTRICAL SUPPLY ASK A QUALIFIED  
 ELECTRICIAN.**



## CALLING FOR SERVICE



- If you are unable to resolve a problem using the checks covered on the last few pages, **do not attempt to service this microwave oven yourself.**
- Contact the dealer or supplier from whom the oven was purchased in order to obtain service. Where this is not possible, please contact the following telephone number: LoCall 0345 125387 **(All calls will be charged at local rate).**
- For general information & assistance with oven queries, please contact our **Customer Information Centre:**  
Telephone: 0990 274 277.

- Replacement parts and accessories may be obtained from our main parts distributor Willow Vale Electronics Ltd, telephone numbers follow.  
Telephone: Manchester: 0161 682 1415  
Reading: 01734 876444



### WARNING

For your own safety, certain microwave oven parts must be replaced by a qualified Engineer appointed by SHARP, these are, therefore, unavailable to customers.

## GUARANTEE



Subject to the conditions listed below, SHARP Electronics (U.K.) Ltd (hereafter called "the Company"), guarantee to provide for the repair of, or, at its option replace this SHARP equipment, or any component thereof, (other than Glass Turntables), which is faulty or below standard, as a result of inferior workmanship or materials.

### The conditions of the Guarantee:

- 1 This Guarantee shall only apply to defects or faults which are notified to the Company, or its Service Technician appointed by Sharp, within one year from the date of purchase of the equipment, provided that this Guarantee shall extend for a further period of one year in respect of microwave oven magnetron parts only.
- 2 This Guarantee covers equipment intended for private domestic use only. This oven is suitable for domestic food preparation and is not designed for commercial, industrial or laboratory use. This Guarantee does not apply to equipment used in the course of a business, trade or profession. Only use the microwave oven for cooking, defrosting or reheating of food. SHARP declines any liability for damages caused by improper use.
- 3 This Guarantee does not cover any faults or defects caused by accident, misuse, fair wear and tear, neglect, tampering with the equipment, or any attempt at adjustment or repair other than by a Service Technician Appointed by Sharp.

Please clean your microwave oven regularly and remove any stains or fat residues without delay. Failure to do this may affect the quality and safety of the product or prejudice your guarantee.

- 4 In the unlikely event of your equipment requiring repair, please contact the dealer or supplier from whom it was purchased. You will need to provide proof of date of purchase to the repairing company. Please keep your invoice or receipt, which is supplied at the time of purchase. Where it is not possible to contact the dealer or supplier from whom the oven was purchased, please contact the telephone number given below. You will then be given details of how to obtain service.

Telephone: 0345 125387

(All calls will be charged at local rate.)

- 5 This Guarantee is offered as an additional benefit to the consumer's statutory rights and does not affect these rights in any way.

SHARP parts and accessories have been specifically designed for SHARP Microwaves.

No liability can be accepted for any inaccuracies or omissions in this publication, although every possible care has been taken to make it as complete and accurate as possible.



# SPECIFICATIONS

AC Line Voltage	Single phase 230-240 V, 50 Hz
Output power:	
Microwave	900W (IEC 705)
Grill (Top Grill)	1200W
Grill (Bottom Grill)	800W
MAFF heating category	D
Input Current:	
Microwave	6.2A
Power Consumption:	
Microwave	1.45kW
Top grill heater	1.25kW
Bottom grill heater	0.85kW
Microwave & Top Grill Heater	2.65kW
Microwave & Bottom Grill Heater	2.25kW
Top & Bottom Grill Heater	2.05kW
Convection	2.1kW
Microwave frequency	2450 MHz
Outside Dimensions	520(W) x 309(H) x 484(D)mm
Cavity Dimensions	349(W) x 207(H) x 357(D) mm
Oven capacity	0.9 cu.ft (26 litres)
Cooking uniformity	Turntable diameter (325mm)
Weight	Approx. 20kg



- This oven complies with the requirements of Directives 89/336/EEC and 73/23/EEC as amended by 93/68/EEC.
- As part of a policy of continuous improvement, we reserve the right to alter design and specification without notice.
- No part of this publication may be reproduced, stored in a retrieval system or transmitted in any form, electronic, mechanical, photocopied, recorded, translated or other means without prior permission from SHARP Electronics (U.K.) Ltd.
- The illustrations, technical information and data contained in this publication to our best knowledge, were correct at the time of going to print. The right to change specifications, at any time, without notice, is reserved as part of our policy of continuous development and improvement.



**SHARP**  
**SHARP ELECTRONICS (U.K.) LTD**  
Manchester, U. K.  
LoCall 0345 125387.

PRINTED IN THE UK  
TINS-A170URR1

## Free Manuals Download Website

<http://myh66.com>

<http://usermanuals.us>

<http://www.somanuals.com>

<http://www.4manuals.cc>

<http://www.manual-lib.com>

<http://www.404manual.com>

<http://www.luxmanual.com>

<http://aubethermostatmanual.com>

Golf course search by state

<http://golfingnear.com>

Email search by domain

<http://emailbydomain.com>

Auto manuals search

<http://auto.somanuals.com>

TV manuals search

<http://tv.somanuals.com>