

SYLVANIA

SRCD858

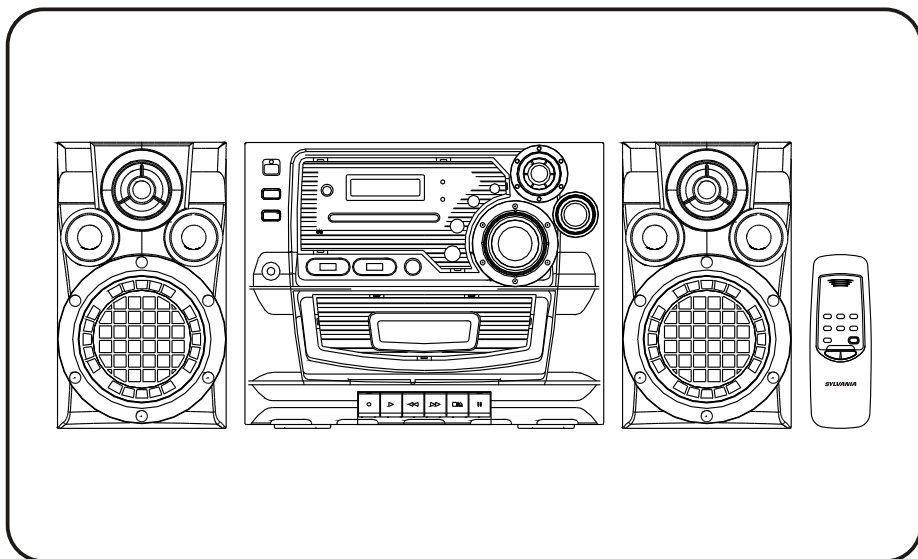

INSTRUCTION MANUAL

WARNINGS

TO Prevent fire or shock hazard, do not use this plug with an extension cord, receptacle or add other outlet unless the blades can be fully inserted to prevent blade exposure. To prevent fire or shock hazard, do not expose this appliance to rain or moisture.



The lightning flash with arrowhead symbol, within an equilateral triangle is intended to alert the user to the presence of 'uninsulated' dangerous voltage' within the product's enclosure that may be of sufficient magnitude to constitute a risk of electric shock to persons.

WARNING

**RISK OF ELECTRICSHOCK
DO NOT OPEN**



CAUTION : TO REDUCE THE RISK OF ELECTRIC SHOCK DO NOT REMOVE COVER (OR BACK),NO USER SERVICEABLE PARTS INSIDE REFER SERVICING TO QUALIFIED SERVICE PERSONNEL

The exclamation point within an equilateral triangle is intended to alert the user to the presence of important operating and maintenance (servicing) instructions in the literature accompanying the appliance

IMPORTANT SAFETY INSTRUCTIONS

- 1 Read these instruction.
- 2 keep these instructions.
- 3 heed all warnings.
- 4 Follow all instructions.
- 5 Do not use this product near water (swimming pool, beach, lake etc.).
- 6 Clean only with a dry cloth.
- 7 Do not block any of the ventilation openings. Install in accordance with the manufacturer's instructions .
- 8 Do not install near any heat sources such as radiators, heat registers . Stoves or other apparatus (including amplifiers) that produce heat.
- 9 Do not defeat the safety purpose of the polarized or grounding-type plug, A polarized plug has two blades with one wider than the other. A grounding type plug has two blades and a third grounding prong. The wide blade or the third prong is provided for your safety. If the provided plug does not fit into your outlet, consult an electrician for replacement of the obsolete outlet.
- 10 Protect the power cord from being walked on or pinched particularly at receptacles and the point where they exit from the stereo.
- 11 Only use attachments/accessories specified by the manufacturer.
- 12 Unplug this apparatus during lightning storms or when unused for long periods of time
- 13 Refer all servicing to qualified service personnel. Servicing is required when the system has been damaged in any way, such as a damaged power-supply cord or plug . Has been exposed to rain or moisture , does not operate normally , or has been dropped.
- 14 This appliance should not be exposed to dripping water or splashing water and objects filled with water, such as vases, should not be placed on this unit

IMPORTANT NOTES

- Avoid installing this unit in places exposed to direct sunlight or close to heat radiating appliances such as electric heaters, on top of other stereo equipment that radiates too much heat, places lacking ventilation or dusty areas, places subject to constant vibration and/or humid or moist areas.
- Do not attempt to clean this unit with chemical solvents as this might damage the finish. Use a clean dry cloth.
- Operate controls and switches as described in the manual.
- Before turning 'On' the power, make certain that power cord is properly installed.
- Store your CDs, in a cool area to avoid damage from heat.
- When moving the set, be sure to first disconnect the power cord.

CLASS 1 LASER PRODUCT

CLASS 1 LASER PRODUCT
APPAREIL À LASER DE CLASSE 1
PRODUCTO LASER DE CLASE 1

CAUTION
INVISIBLE LASER RADIATION
WHEN OPEN AND INTERLOCKS
DEFEATED.
AVOID EXPOSURE TO BEAM



This product contains a low power Laser Device.

FCC INFORMATION

This equipment has been tested and found to comply with the limits for a Class B digital device, pursuant to Part 15 of the FCC Rules. These limits are designed to provide reasonable protection against harmful interference in a residential installation. This equipment generates, uses, and can radiate radio frequency energy and, if not installed and used in accordance with the instructions, may cause harmful interference to radio communications. However, there is no guarantee that interference will not occur in a particular installation. If this equipment does cause harmful interference to radio or television reception, which can be determined by turning the equipment off and on, the user is encouraged to try to correct the interference by one or more of the following measures:

- Reorient or relocate the receiving antenna.
- Increase the separation between the equipment and receiver.
- Connect the equipment into an outlet on a circuit different from that to which the receiver is connected.
- Consult the dealer or an experienced radio/TV technician for help.

This device complies with Part 15 of the FCC Rules. Operation is subject to the following two conditions:

- (1) This device may not cause harmful interference, and
- (2) This device must accept any interference received, including interference that may cause undesired operation.

UNPACKING AND SET-UP

- Carefully remove the unit from the carton and remove all packing material from the unit.
- Remove any labels or stickers which may be on the front or top of the set, but do not remove any labels from the back or bottom.
- We suggest that you retain the original carton and packing materials in case it ever becomes necessary to return your unit for service. This is the only sure way to protect the unit from damage in transit.
- Remove any small strips of tape that may have been used to prevent the CD door from opening in transit.
- Unwind the lead wire FM antenna on the back of the unit and extend it to its full length.
- The unit is shipped with a dummy CD display card in the CD player. This dummy CD card must be removed before you can use the CD player.

SPEAKER CONNECTION

Connect each speaker to the corresponding speaker jack on the back panel of the main unit. Make sure that the left speaker plug is connected to the left (L) speaker jack and the right speaker plug is connected to the right (R) speaker jack.

POWER SOURCE

This system is designed to operate on 120V 60Hz AC house current. Connecting this system to any other power supply could result in damage to the unit which is not covered by your warranty. You will note that this system is equipped with a polarized AC power plug having one blade wider than the other. This is a safety feature. If this plug does not fit into your existing AC outlet, do not try to defeat this safety feature by filing the wide blade to make it fit into your outlet. If this plug will not fit into your outlet, you probably have an out-dated non-polarized AC outlet. You should have your outlet changed by a qualified licensed electrician.

AC OPERATION

- 1.) Unwind the AC Power Cord completely.
- 2.) Insert the plug into any convenient 120V 60Hz AC outlet.

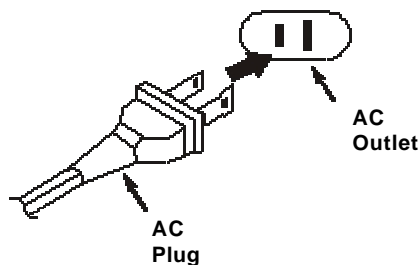

PROTECT YOUR FURNITURE

This model is equipped with non-skid rubber 'feet' to prevent the product from moving when you operate the controls. These 'feet' are made from non-migrating rubber material specially formulated to avoid leaving any marks or stains on your furniture. However certain types of oil based furniture polishes, wood preservatives, or cleaning sprays may cause the rubber 'feet' to soften, and leave marks or a rubber residue on the furniture. To prevent any damage to your furniture we strongly recommend that you purchase small self-adhesive felt pads, available at hardware stores and home improvement centers everywhere, and apply these pads to the bottom of the rubber 'feet' before you place the product on fine wooden furniture.

LOCATION OF CONTROLS

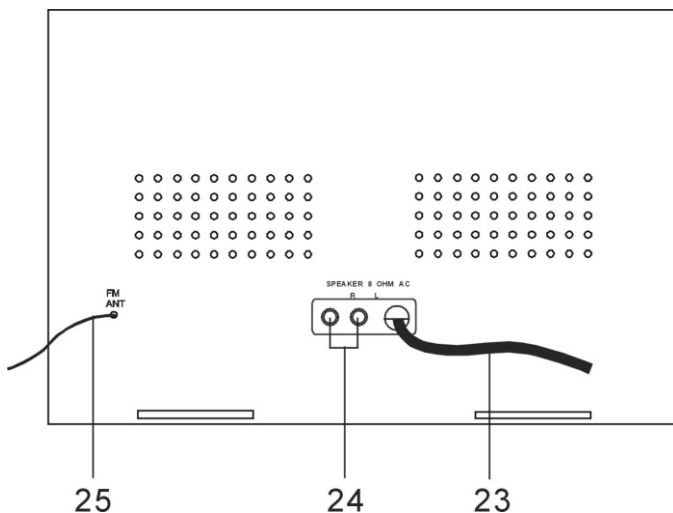
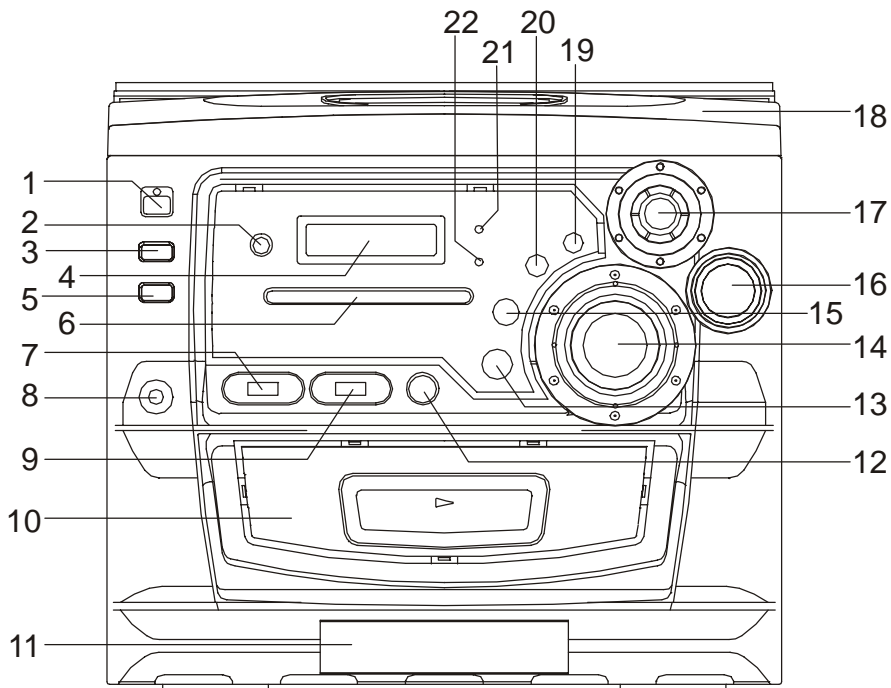

LOCATION OF CONTROLS

- | | |
|--|---------------------|
| 1. STANDBY Button | Rear of Unit |
| 2. REMOTE Sensor | 23. AC Main Lead |
| 3. PROGRAM Button | 24. Speaker Sockets |
| 4. LCD Display | 25. FM Antenna wire |
| 5. CD REPEAT Button | |
| 6. Radio Dial Scale | |
| 7. FUNCTION Selector | |
| 8. HEADPHONES Socket | |
| 9. RADIO BAND Selector | |
| 10. CASSETTE Compartment | |
| 11. CASSETTE keys
RECORD, PLAY , FAST REWIND,
FAST FORWARD, STOP / EJECT,
PAUSE | |
| 12. DISC Button | |
| 13. CD PLAY/PAUSE Button. | |
| 14. TUNING Knob | |
| 15. CD STOP Button | |
| 16. BASS BOOST Button | |
| 17. VOLUME Control Buttons | |
| 18. CD Tray | |
| 19. CD SKIP/SEARCH
Forwards Button | |
| 20. CD SKIP/SEARCH Backwards
Button | |
| 21. FM Stereo Indicator | |
| 22. MUTE Indicator | |

PREPARATION FOR USE

Remove the stereo carefully from the box, retaining the packaging for future use.
Read these instructions carefully before use.

CONNECTIONS

Before switching on your stereo system, be sure that it is connected as follows:

SPEAKERS

Connect the speakers to the speaker sockets on the back of the music system.

- Connect the left speaker to the left speaker socket and the right speaker to the right speaker socket.
- Connect the Mains Lead to an AC outlet.
- Insert two R03S (AAA or equivalent) batteries into the battery compartment of the remote control (Batteries are not included).

You are now ready to switch on the power.

LISTENING TO THE RADIO

OPERATION

- Press the STANDBY Button to turn the unit on, the Stand-By indicator will go out.
- Select the Function Selector to TUNER and turn the radio band selector to AM or FM STEREO position.
- Tune into the station using the TUNING knob.
- Adjust the VOLUME to the desired level using the VOLUME Control Button.
- To turn off the radio, press the STANDBY Button.

HANDLING COMPACT DISCS

To remove a disc from its storage case, press down on the center of the case and lift the

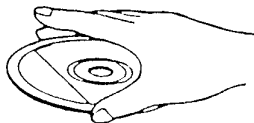
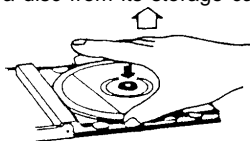

disc out, holding it carefully by the edges.

Fingerprints and dust should be carefully wiped off the disc's recorded surface with a soft cloth. Unlike conventional records, compact discs have no grooves to collect dust and microscopic debris so gently wiping with a soft cloth should remove most particles. Wipe in a straight line from the inside to the outside of the disc. Small dust particles and light stains will have absolutely no effect on reproduction quality.

Never use chemicals such as record sprays, antistatic sprays, benzene, or thinners to clean compact discs. These chemicals can irreparably damage the disc's surface.

Discs should be returned to their cases after use. This avoids serious scratches that could cause the Laser pickup to skip.

Do not expose discs to direct sunlight, high humidity, or high temperatures for extended periods. Long exposure to high temperatures can warp the disc.

LOADING DISCS

LOADING AND UNLOADING COMPACT DISCS

- Set the FUNCTION Selector to the CD position.
- Open the disc compartment.
- Once the CD cover has opened, remove a disc from its case and place it carefully in one of the indentations in the compartment with the label side facing up. Smaller, 3" discs, may also be used with this CD player.
- To load additional CD's press the DISC button to rotate the CD tray. Up to 3 discs can be placed in the tray at any one time. Smaller 3 inch discs can be used in this unit.
- Close the disc compartment.
- The unit will go through a cycle to find the first CD there is in the tray. This may take up to 15 seconds.
- The disc compartment may be opened at any time.

CAUTION

- Do not put anything except a compact disc into the compartment. Foreign objects can damage the mechanism.
- Do not force the compartment by hand during the opening and closing operations.
- Keep the disc compartment closed when not in use to prevent dirt and dust from entering the mechanism.

SUPER BASS

To enhance Bass effect to the desired level using the Bass Control Button.

PLAYING DISCS

- Open the disc compartment, and load a CD.
- Close the disc compartment and the unit will search for the first tray to contain a CD and the display will show the total playing time of the CD.
- Press the CD DISC Button to select the CD of your choice.
- Press the PLAY/PAUSE Button and disc play will begin from the beginning of the first track.
A particular track can be selected by pressing the ◀ & ▶ Buttons. If this is done before pressing the PLAY/PAUSE Button, disc play will start with the selected track when the PLAY/PAUSE Button is pressed.
- At the end of the disc, the unit will switch to stop mode

*Notes: If the disc is deeply scratched, or too dirty, disc play may not start.
If an improperly centered disc is played, noise can be heard in the mechanism. The use of such discs should be avoided.*

IMPORTANT INFORMATION

This compact disc player has built-in error compensation circuits to correct minor defects in a disc. There are limits, however, to the amount of corrections available.

In some cases, the CD player may skip some tracks on a disc during disc play. This problem may be caused by defects (such as scratches) in the disc being played which are too large for the error compensation circuits to handle. If you encounter this problem, check the CD player's operation as follows, before having the unit serviced.

Play a new disc. If the CD player operates normally, the skipping problem is probably due to a defective disc.

TO STOP A CD PART WAY THROUGH

- Press the STOP Button. Disc play will stop, the display will show the total number of tracks and the total playing time of the CD.
- To temporarily stop disc play (pause mode), press the PLAY/PAUSE Button. Disc play will pause at the current play position.
- To resume disc play, press the PLAY/PAUSE Button again. The Play indicator will be displayed.

TRACK SKIP

TO SKIP TO THE NEXT TRACK ON A DISC

- For example, to skip ahead to the beginning of track 5 while track 4 is playing:
- Press the ►► Button once. Disc play will resume at the beginning of track 5.

The CD player will skip ahead to the next track each time the ►► Button is pressed. Repeatedly pressing the Forward Skip Track Button makes the CD player skip ahead through the disc track by track. Once the beginning of the last track is reached the CD player will not advance any further.

TO SKIP BACK TO THE PREVIOUS TRACK ON A DISC

- For example to skip back to the beginning of track 3 while track 4 is playing:
- Press the ◄◄ Button twice. Disc play will resume at the beginning of track 3.

The CD player will skip back one track each time the ◄◄ Button is pressed. If this Button is pressed once in the middle of a track, the CD player will skip back to the beginning of that track. To make it skip back to the previous track press the ◄◄ Button twice.

Repeatedly pressing the ◄◄ Button makes the CD player skip back through the disc track by track. Once the beginning of the first track is reached, the CD player will not go back any further.

Notes: The **⏮** & **⏭** Buttons can be used to select a desired track to play before disc play starts. In this case the number of the selected track will be displayed until the Play/Pause Button is pressed.

DISC SKIP

- To skip to the next disc simply press the DISC SKIP Button. The unit will cycle through position 1 - 2 - 3 - 1 - 2etc

REPEAT DISC PLAY

If the REPEAT Button is pressed during normal or programmed disc play the following repeat functions are displayed in sequence in the CD Display.

REPEAT ALL DISC	Repeats All the Tracks on All the Discs
REPEAT 1 DISC	Repeats all the tracks on the Current disc.
REPEAT 1	Repeats the current track on the Current disc.

To cancel a repeat mode, keep pressing the REPEAT Button until the REPEAT Indicator disappears.

PROGRAMMED DISC PLAY

It is not possible to enter programs during disc play. Press the STOP Button first, then follow the instructions below.

ENTERING A PROGRAM

1. Press the PROGRAM Button and the CD Display will display the word Program edit and 01 d:--
2. Select the disc that the first track is on using the Disc Skip Button.
3. Select the desired track using the Track skip buttons until the desired track is reached and the display will show Program edit and 01 d2:04.
4. Press the PROGRAM Button once again and the selected disc and track number is then stored in memory. The CD Display will change to Program edit and 02 d2:--
5. Repeat steps 2 - 4 to enter additional tracks. You can store up to 32 programs in memory.

Notes: *If the PLAY/PAUSE Button is pressed before the PROGRAM Button is pressed to store a track, the track will not be programmed and the disc will start playing from the first selected track.*

Any track can be programmed to play more than once.

If you press the STOP Button during PROGRAM mode, the entire program will be erased from memory.

LISTENING TO PROGRAMMED TRACKS

Program your selection of tracks by following the procedure shown above.

Press the PLAY/PAUSE Button.

Disc play will start at the beginning of the first programmed track.

TO CLEAR THE PROGRAMMED MEMORY

If the disc is playing, press the STOP Button.

Press the STOP Button again. All the programs will then be erased from memory.

The program memory will also be cleared if the Function Selector is changed to another function, or if the power is switched off.

LISTENING TO TAPE

INSERTION AND REMOVAL OF CASSETTES

- Press the Stop/Eject Button to open the Cassette Door.
- Slip your cassette tape into the cassette door with the exposed section of tape at the bottom and the playback side facing you.
- Close the Cassette Door securely before starting.
- When finished, press the STOP/EJECT Key to open the Cassette Door, and retrieve your cassette tape.

PLAYING TAPES

- Select the TAPE Option using the FUNCTION Selector.
- Insert your cassette tape.
- Press the PLAY Key to start the tape.
- Use the PAUSE Key whenever you want to suspend playback.
- Press the STOP/EJECT Key when finished.

RECORDING

RECORDING FROM THE RADIO

- Select the AM or FM STEREO Option using the FUNCTION Selector.
- Tune in your station and insert a cassette tape into tape deck.
- Press the RECORD Key and the PLAY Key at the same time to start recording.
- Press the STOP/EJECT Key when finished.

RECORDING FROM CD

- Select the CD Option using the FUNCTION Selector, and insert your disc.
- Press the RECORD Key and the PLAY Key at the same time to start recording.
- Press the CD PLAY/PAUSE Button to start the disc.
- Press the STOP/EJECT Key when finished.

COPYRIGHT NOTICE WARNING

Most records, compact discs, audio and video cassettes, radio and television broadcasts contain material which is subject to copyright laws. It is unlawful to record such material in any form whatsoever, whether on disc or tape, without the permission of the copyright owner concerned. Any person who makes a recording of such material without the consent of the copyright owner infringes on copyright laws and may be liable to pay substantial damages to the copyright owner, and in some cases subject to criminal prosecution.

HEADPHONES

Headphones should have a 3.5 mm diameter stereo plug with an impedance of 8-32 ohms. When headphones are connected, the speakers are automatically disconnected.

REMOTE CONTROL

1. STANDBY Button
2. STOP Button
3. PLAY / PAUSE Button
4. CD SKIP Buttons
5. PROGRAM Button
6. DISC SKIP Button
7. MUTE Button
8. VOLUME UP/DOWN Buttons.

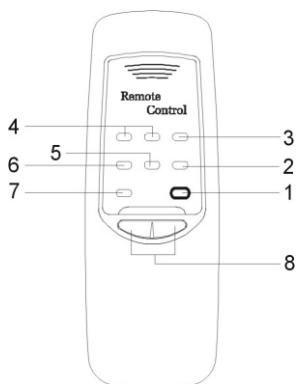

BATTERY INSTALLATION

Insert 2 R03S (AAA or equivalent) size batteries into the battery compartment of the remote control and replace the cover (Batteries are not included).

BATTERY REPLACEMENT

When the batteries become too weak, the operating distance of the remote control is greatly reduced and you will need to replace the batteries.

Note: To maintain the accuracy and long life of the transmitter, do not press two or more Buttons simultaneously.

If the remote control is not to be used for a long time, remove the batteries to prevent possible damage through leaking batteries.

Do not mix different types of batteries, or old batteries with new ones.

USING THE REMOTE CONTROL CORRECTLY

Point the remote control at the Remote Sensor.

The functions of the Buttons on the remote control are the same as the corresponding controls on the main unit.

When there is a strong ambient light source, the performance of the infrared Remote Sensor may be degraded, causing unreliable operation.

The maximum effective distance for remote control operation is about 5 metres (16.5 feet).

MUTE

- Press the MUTE Button on the remote control to switch off the sound, (the MUTE indicator will light up).
- Press MUTE again to restore the sound to the previous level (the MUTE indicator will go off).

CASSETTE CARE

Two common causes of trouble experienced when using cassettes are:—

- (a) Tape jamming - Leading to uneven speed in playback, and
- (b) Tape tangling - Where the tape wraps itself around vital parts of the mechanism.

To reduce the likelihood of these problems occurring, the following precautions should be observed.

Check that there are no loose layers of tape visible through the cassette center window (see Fig. 1). Take up any loose layers, using a pencil or hexagonal barrelled ballpoint pen, before inserting the cassette into the machine (see Fig. 2).

If the cassette feels "tight" while performing operation shown in Fig. 2, the tape may be jamming due to "ridges" formed in the winding of the tape (visible through the center window). These may be removed, in most cases, by fast winding of the cassette from one end to the other and back again.

Use only well-known brands of tape.

Avoid use of C-120 cassettes.

Furthermore, do not expose cassettes to direct sunlight, dust or oil, and do not touch the tape surfaces.

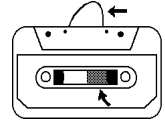

Fig.1

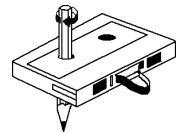
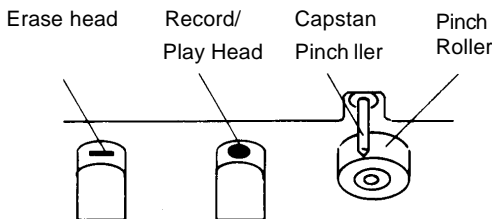

Fig.2

HEAD CLEANING

The tape heads, pinch roller and capstan require periodic cleaning. This removes particles of the metal oxide coating that wear off the tape and accumulate on these parts and impair performance. Switch off the power, press the STOP/EJECT Button to open the cassette door, and press the PLAY Button. Clean the tape heads, pinch roller and capstan with a soft cloth or cotton bud dampened in isopropylalcohol or special tape head cleaner.



PREVENTION AGAINST ACCIDENTAL ERASURE

To prevent a recording on a cassette tape being erased accidentally, break off the tab on the rear of the tape, as in the diagram. Now recording on this side is no longer possible. You can render this protection ineffective by covering the hole with a piece of adhesive tape.

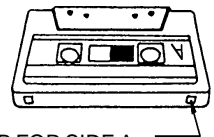

TAB FOR SIDE A

MAINTENANCE AND CARE

Electronic products of this kind should never be subjected to extreme temperatures or high humidity. For instance, this set should not be placed in bathing areas or around stoves and radiators.

If necessary, clean the unit with a piece of cloth dampened with water only (Be sure the AC Power Cord is disconnected from the Mains). Never use a polish or a strong detergent as this will damage the finish of the cabinet.

This equipment has been designed and manufactured to meet the highest international standards, but, like any electrical apparatus which is operated at mains voltage, care must be taken if you are to obtain the best results and safety is to be assured. This is particularly important with audio equipment.

- DO. . . Read the operating instructions before you attempt to use the equipment.
- DO. . . Ensure that all electrical connections (including the mains plug, extension leads and interconnections between pieces of equipment) are properly made and in accordance with the manufacturer's instructions. Check that the mains fuse rating is correct.
- DO. . . Always consult your dealer if you are ever in doubt about the installation, operation or safety of your equipment. He is the best person to advise you.
- DON'T. . . Obstruct the necessary ventilation - especially DON'T stand the set close to curtains or on soft furnishing such as carpets. Overheating can cause unnecessary damage and shorten the life of the set.

Remember that to obtain the best performance and lasting satisfaction from your equipment, have it regularly checked by a reliable service organization. Ensure that it is correctly used by all family members.

ABOVE ALL. . .

Never let children push anything into holes or slots in the case - this could result in an electric shock.

SPECIFICATIONS

Power Supply

AC: 120V ~ 60 Hz

Radio Frequency Coverage

FM: 88 - 108 MHz

AM: 530 - 1710 kHz

Recording System

Recording System: DC Bias

Erasing System: Magnetic Erase

General

Speaker Impedance 8 Ohms

Headphones: 3.5mm stereo jack plug, 8-32 Ohms

CD Player

Pick Up: 3-Beam, Semiconductor Laser

Encoding: 16-Bit Linear 2x Oversampling

Due to continuing improvements, the features and design are subject to change without notice.

For service assistance and product information, please call: 1-800-968-9853.

MADE IN CHINA

Free Manuals Download Website

<http://myh66.com>

<http://usermanuals.us>

<http://www.somanuals.com>

<http://www.4manuals.cc>

<http://www.manual-lib.com>

<http://www.404manual.com>

<http://www.luxmanual.com>

<http://aubethermostatmanual.com>

Golf course search by state

<http://golfingnear.com>

Email search by domain

<http://emailbydomain.com>

Auto manuals search

<http://auto.somanuals.com>

TV manuals search

<http://tv.somanuals.com>