

**SYLVANIA
LIMITED WARRANTY**

FUNAI CORP. will repair this SYLVANIA product, free of charge in the USA in the event of defect in materials or workmanship as follows:

- DURATION:**
PARTS: FUNAI CORP. will provide parts to replace defective parts without charge for one (1) year from the date of original retail purchase. Two (2) years for Picture Tube. Certain parts are excluded from this warranty.
LABOR: FUNAI CORP. will provide the labor without charge for a period of ninety (90) days from the date of original retail purchase.

LIMITS AND EXCLUSIONS:

THIS WARRANTY IS EXTENDED ONLY TO THE ORIGINAL RETAIL PURCHASER. A PURCHASE RECEIPT OR OTHER PROOF OF ORIGINAL RETAIL PURCHASE WILL BE REQUIRED TOGETHER WITH THE PRODUCT TO OBTAIN SERVICE UNDER THIS WARRANTY.

This warranty shall not be extended to any other person or transferee.

This warranty is void and of no effect if any serial numbers on the product are altered, replaced, defaced, missing or if service was attempted by an unauthorized service center. This SYLVANIA Limited warranty does not apply to any product not purchased and used in the United States.

This warranty only covers failures due to defects in material or workmanship which occurs during normal use. It does not cover damage which occurs in shipment, or failures which are caused by repairs, alterations or product not supplied by FUNAI CORP., or damage which results from accident, misuse, abuse, mishandling, misapplication, alteration, faulty installation, improper maintenance, commercial use such as hotel, rental or office use of this product or damage which results from fire, flood, lightning or other acts of God.

THIS WARRANTY DOES NOT COVER PACKING MATERIALS, ANY ACCESSORIES (EXCEPT REMOTE CONTROL), ANY COSMETIC PARTS, COMPLETE ASSEMBLY PARTS, DEMO OR FLOOR MODELS.

FUNAI CORP. AND ITS REPRESENTATIVES OR AGENTS SHALL IN NO EVENT BE LIABLE FOR ANY GENERAL, INDIRECT OR CONSEQUENTIAL DAMAGES ARISING OUT OF OR OCCASIONED BY THE USE OF OR THE INABILITY TO USE THIS PRODUCT. THIS WARRANTY IS MADE IN LIEU OF ALL OTHER WARRANTIES, EXPRESS OR IMPLIED, AND OF ALL OTHER LIABILITIES ON THE PART OF FUNAI. ALL OTHER WARRANTIES INCLUDING THE WARRANTY OF MERCHANTABILITY, AND FITNESS FOR A PARTICULAR PURPOSE, ARE HEREBY DISCLAIMED BY FUNAI AND ITS REPRESENTATIVES IN THE UNITED STATES.

ALL WARRANTY INSPECTIONS AND REPAIRS MUST BE PERFORMED BY FUNAI AUTHORIZED SERVICE CENTER. THIS WARRANTY IS VALID WHEN THE UNIT IS CARRIED-IN TO FUNAI AUTHORIZED SERVICE FACILITY.

THE PRODUCT MUST BE ACCOMPANIED BY A COPY OF THE ORIGINAL RETAIL PURCHASE RECEIPT. IF NO PROOF OF PURCHASE IS ATTACHED, THE WARRANTY WILL NOT BE HONORED AND REPAIRS COSTS WILL BE CHARGED.

IMPORTANT:

THIS LIMITED WARRANTY GIVES YOU SPECIFIC LEGAL RIGHTS. YOU MAY HAVE OTHER RIGHTS THAT VARY FROM STATE TO STATE. IF, AT ANY TIME DURING THE WARRANTY PERIOD, YOU ARE UNABLE TO OBTAIN SATISFACTION WITH THE REPAIR OF THIS PRODUCT, PLEASE CONTACT FUNAI CORP.

ATTENTION:

FUNAI CORP. RESERVES THE RIGHT TO MODIFY ANY DESIGN OF THIS PRODUCT WITHOUT PRIOR NOTICE.

To locate your nearest SYLVANIA Authorized Service Center or general service procedure, please call 1-800-968-3429 or write to the following:

FUNAI CORPORATION
Customer Service
100 North Street, Teterboro, NJ 07608
Tel :1-800-968-3429
<http://www.funai-corp.com>

PLEASE DO NOT SHIP YOUR UNIT TO THE TETERBORO ADDRESS.

OEMN02197

Printed in Malaysia
L6610UA * * * * *

Owner's Manual

SYLVANIA
27 INCH
COLOR TELEVISION
6427FD

FEATURES

- **MTS/SAP Tuner**
- **181 Channel Selection-** All VHF/UHF channels plus up to 125 cable channels.
- **PLL Frequency Synthesized Tuning-** The latest PLL frequency synthesized electronic tuning system provides free and easy channel selection, and lets you tune directly to any channel using the channel number buttons (0~9 and +100-key) on the remote control.
- **On-Screen Function Display.**
- **Full-Function Remote Control**
- **Sleep Timer**
- **Closed Caption Decoder-** You may view specially labeled (cc) TV programs, movies, news, prerecorded tapes, etc. with either a dialogue caption or text display added to the program.
- **Auto Shut Off Function-** If there is no air signal input from the antenna terminal and no user operation for 15 minutes, the TV will turn itself off automatically.
- **V-CHIP-** Enables parents to prevent their children from watching inappropriate material on TV.
- **S-VIDEO Input-** Allows you to get better picture detail and clarity for the playback of S-VHS VCR tapes or Video Discs.
- **Front / Rear AV Input**
- **Component VIDEO Input**
- **Rear Audio Output**

PRECAUTIONS

- Place your TV in a room with adequate ventilation.
- Keep your TV set away from sources of direct heat, such as heat registers or direct sunlight.
- Do not place your TV on soft surfaces, such as rugs or blankets.
- Leave enough room for air to circulate around the bottom, top and back of the set.

The serial number of this product may be found on the back of the TV. No others have the same serial number as yours. You should record the number and other vital information here and retain this book as a permanent record of your purchase to aid identification in case of theft.

Date of Purchase		Dealer Phone No.	
Dealer Purchase from		Model No.	
Dealer Address		Serial No.	

This Owner's Manual is made of recycled paper.

IF YOU NEED ADDITIONAL ASSISTANCE FOR SET-UP OR OPERATING AFTER READING OWNER'S MANUAL, PLEASE CALL TOLL FREE 1-800-968-3429, OR VISIT OUR WEB SITE AT <http://www.funai-corp.com>

ANTENNA/CABLE CONNECTIONS

CAUTION: TO PREVENT ELECTRIC SHOCK, MATCH WIDE BLADE OF PLUG TO WIDE SLOT, FULLY INSERT.

ATTENTION: POUR ÉVITER LES CHOC ÉLECTRIQUES, INTRODUIRE LA LAME LA PLUS LARGE DE LA FICHE DANS LA BORNE CORRESPONDANTE DE LA PRISE ET POUSSER JUSQU'AU FOND.

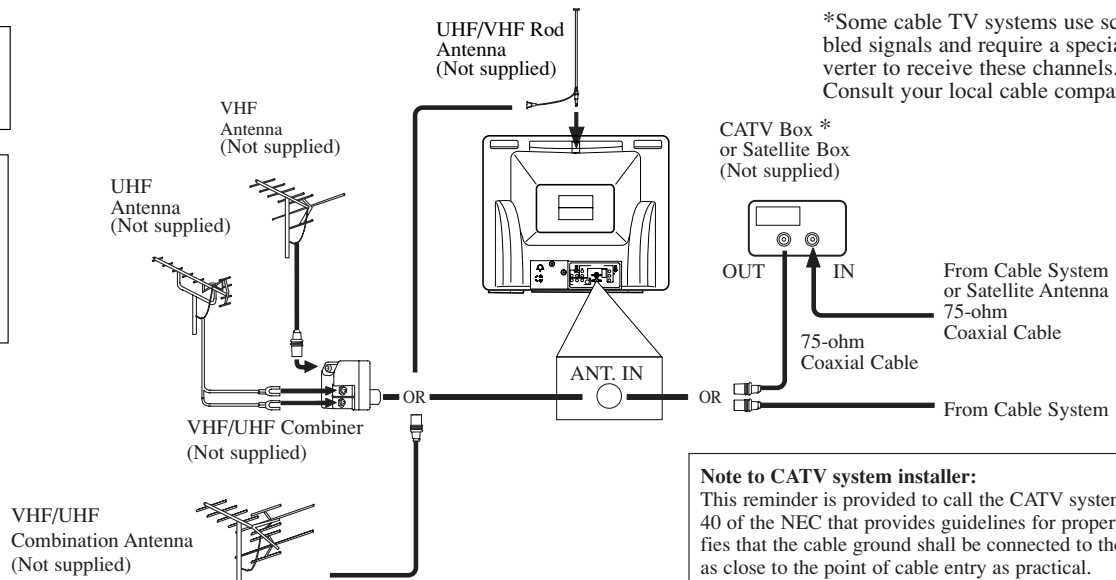

*Some cable TV systems use scrambled signals and require a special converter to receive these channels. Consult your local cable company.

FCC WARNING- This equipment may generate or use radio frequency energy. Changes or modifications to this equipment may cause harmful interference unless the modifications are expressly approved in the instruction manual. The user could lose the authority to operate this equipment if an unauthorized change or modification is made.

Note to CATV system installer:

This reminder is provided to call the CATV system installer's attention to Article 820-40 of the NEC that provides guidelines for proper grounding and, in particular, specifies that the cable ground shall be connected to the grounding system of the building as close to the point of cable entry as practical.

CLOSED CAPTION

This TV can receive C1 and C2 Caption and Text.

Caption Mode

- (1) Closed Caption Characters can be displayed on the TV screen only when the received broadcast signal contains Caption Signals.
 - (2) **Paint-on mode:** Displays input characters on the screen immediately.
Pop-on mode: Once characters are stored in memory, they are displayed all at once.
Roll-up mode: Displays the characters continuously by scrolling (max. 4 lines)
- Note:** If CAPTION C1 or C2 is selected but a Closed Caption signal is not included, characters will not be displayed.

Text Mode

- (1) Displays the text on the screen by scrolling (max. 7 lines)
- (2) If the received broadcast signal does not contain caption or text signals, no change will occur.

Notes:

- (1) When your TV receives a special effects playback signal (i.e., Search, Slow, Still) from a VCR's video output channel (CH3 or CH4), your TV may not display the correct caption or text.
- (2) Captions and texts may not match the TV voice exactly.
- (3) Interference may cause the closed caption system not to function properly.
- (4) The caption or text characters will not be displayed while the menu display or functions display is shown.
- (5) **If you see this screen:**

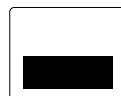

If your TV displays a black box on the screen, this means that your TV is set to TEXT mode. To clear screen, select CAPTION C1, C2 or CAPTION [OFF].

WARNING:

TO REDUCE THE RISK OF FIRE OR ELECTRIC SHOCK, DO NOT EXPOSE THIS APPLIANCE TO RAIN OR MOISTURE.

CAUTION

**RISK OF ELECTRIC SHOCK
DO NOT OPEN**

CAUTION: TO REDUCE THE RISK OF ELECTRIC SHOCK, DO NOT REMOVE COVER (OR BACK) NO USER SERVICEABLE PARTS INSIDE. REFER SERVICING TO QUALIFIED SERVICE PERSONNEL.



THIS SYMBOL INDICATES THAT DANGEROUS VOLTAGE CONSTITUTING A RISK OF ELECTRIC SHOCK IS PRESENT WITHIN THIS UNIT.



THIS SYMBOL INDICATES THAT THERE ARE IMPORTANT OPERATING AND MAINTENANCE INSTRUCTIONS IN THE LITERATURE ACCOMPANYING THE APPLIANCE.

The important note is located on the rear of the cabinet.

IMPORTANT SAFEGUARDS

1. Read instructions-All the safety and operating instructions should be read before the appliance is operated.
2. Retain Instructions-The safety and operating instructions should be retained for future reference.
3. Heed Warnings-All warnings on the appliance and in the operating instructions should be adhered to.
4. Follow Instructions-All operating and use instructions should be followed.
5. Cleaning-Unplug TV from the wall outlet before cleaning. Do not use liquid cleaners or aerosol cleaners. Use a damp cloth for cleaning.

EXCEPTION: A product that is meant for uninterrupted service and, that for some specific reason, such as the possibility of the loss of an authorization code for a CATV converter, is not intended to be unplugged by the user for cleaning or any other purpose, may exclude the reference to unplugging the appliance in the cleaning description otherwise required in item 5.

6. Attachments-Do not use attachments not recommended by the TV manufacturer as they may cause hazards.
7. Water and Moisture-Do not use this TV near water, for example, near a bath tub, wash bowl, kitchen sink, or laundry tub, in a wet basement, or near a swimming pool, and the like.

8. Accessories-Do not place this TV on an unstable cart, stand, tripod, bracket, or table. The TV may fall, causing serious injury to someone, and serious damage to the appliance. Use only with a cart, stand, tripod, bracket, or table recommended by the manufacturer, or sold with the TV. Any mounting of the appliance should follow the manufacturer's instructions and should use a mounting accessory recommended by the manufacturer. An appliance and cart combination should be moved with care. Quick stops, excessive force, and uneven surfaces may cause the appliance and cart combination to overturn.

PORTABLE CART WARNING



AMEUBLES- Cet appareil ne doit être placé que sur un meuble (avec ou sans roulettes) recommandé par le fabricant. Si vous l'installez sur un meuble à roulettes, déplacez les deux ensembles avec précaution. Un arrêt brusque, l'utilisation d'une force excessive et des surfaces irrégulières risquent de déstabiliser l'ensemble et de le renverser.



9. Ventilation-Slots and openings in the cabinet and the back or bottom are provided for ventilation and to ensure reliable operation of the TV and to protect it from overheating, these openings must not be blocked or covered. The openings should never be blocked by placing the TV on a bed, sofa, rug, or other similar surface. This TV should never be placed near or over a radiator or heat register. This TV should not be placed in a built-in installation such as a bookcase or rack unless proper ventilation is provided or the manufacturer's instructions have been adhered to.
10. Power Sources-This TV should be operated only from the type of power source indicated on the marking label. If you are not sure of the type of power supply to your home, consult your appliance dealer or local power company. For TVs intended to operate from battery power, or other sources, refer to the operating instructions.
11. Grounding or Polarization-This TV is equipped with a polarized alternating-current line plug (a plug having one blade wider than the other). This plug will fit into the power outlet only one way. This is a safety feature. If you are unable to insert the plug fully into the outlet, try reversing the plug. If the plug should still fail to fit, contact your electrician to replace your obsolete outlet. Do not defeat the safety purpose of the polarized plug.

FIGURE A
EXAMPLE OF ANTENNA GROUNDING AS PER
NATIONAL ELECTRICAL CODE

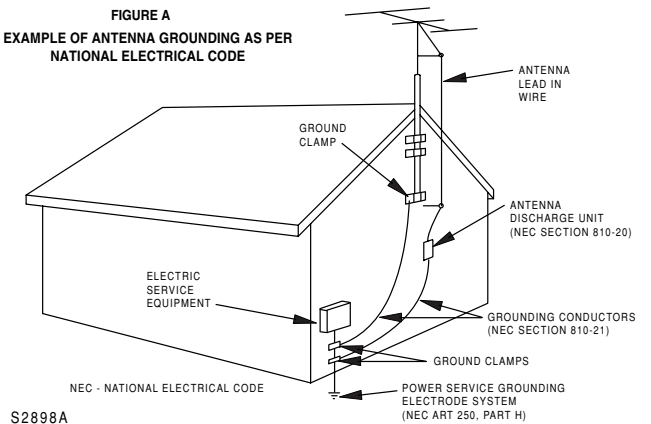

12. Power-Cord Protection-Power-supply cords should be routed so that they are not likely to be walked on or pinched by items placed upon or against them, paying particular attention to cords at plugs, convenience receptacles, and the point where they exit from the appliance.
13. Outdoor Antenna grounding-If an outside antenna or cable system is connected to the TV, be sure the antenna or cable system is grounded so as to provide some protection against voltage surges and built-up static charges. Article 810 of the National Electrical Code, ANSI/NFPA No. 70, provides information with respect to proper grounding of the mast and supporting structure, grounding of the lead-in wire to an antenna discharge unit, size of grounding conductors, location of antenna-discharge unit, connection to grounding electrodes, and requirements for the grounding electrode. (Fig. A)
14. Lightning-For added protection for this TV receiver during a lightning storm, or when it is left unattended and unused for long periods of time, unplug it from the wall outlet and disconnect the antenna or cable system. This will prevent damage to the TV due to lightning and power-line surges.
15. Power Lines-An outside antenna system should not be located in the vicinity of overhead power lines or other electric light of power circuits, or where it can fall into such power lines or circuits. When installing an outside antenna system, extreme care should be taken to keep from touching such power lines or circuits as contact with them might be fatal.
16. Overloading-Do not overload wall outlets and extension cords as this can result in a risk of fire or electric shock.
17. Object and Liquid Entry-Never push objects of any kind into this TV through openings as they may touch dangerous voltage points or short out parts that could result in a fire or electric shock. Never spill liquid of any kind on the TV.

18. Servicing-Do not attempt to service this TV yourself as opening or removing covers may expose you to dangerous voltage or other hazards. Refer all servicing to qualified service personnel.
19. Damage Requiring Service-Unplug this TV from the wall outlet and refer servicing to qualified service personnel under the following conditions:
 - a. When the power supply cord or plug is damaged or frayed.
 - b. If liquid has been spilled, or objects have fallen into the TV.
 - c. If the TV has been exposed to rain or water.
 - d. If the TV does not operate normally by following the operating instructions. Adjust only those controls that are covered by the operating instructions, as improper adjustment of other controls may result in damage and will often require extensive work by a qualified technician to restore the TV to its normal operation.
 - e. If the TV has been dropped or damaged in any way.
 - f. When the TV exhibits a distinct change in performance-this indicates a need for service.
20. Replacement Parts-When replacement parts are required, be sure the service technician uses replacement parts specified by the manufacturer that have the same characteristics as the original part. Unauthorized substitutions may result in fire, electric shock, injury to persons or other hazards.
21. Safety Check-Upon completion of any service or repairs to this TV, ask the service technician to perform routine safety checks to determine that the TV is in proper operating condition.
22. Heat-This TV product should be situated away from heat sources such as radiators, heat registers, stoves, or other products (including amplifiers) that produce heat.

OPERATING CONTROLS AND FUNCTIONS

- FRONT PANEL -

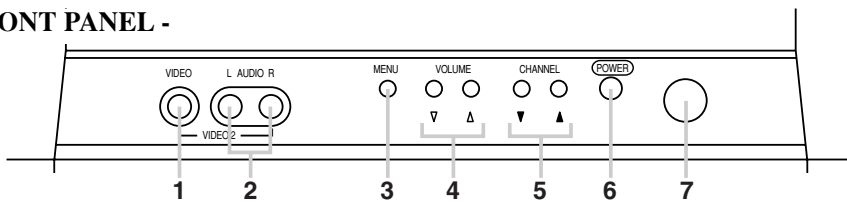

- REMOTE CONTROL -

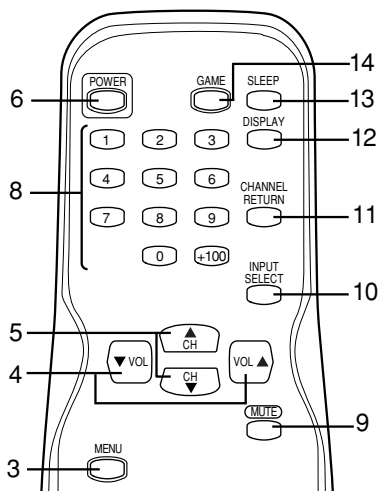

1. VIDEO (in) jack- Connect to the video output jack of a video camera or VCR.
2. AUDIO L/R IN jacks- Connect to the left/right channel audio output jacks of a video camera or VCR. **NOTE:** The AUDIO L (IN) jack is for mono input. The sound is heard from both speakers. Use this jack for monaural audio equipment to be hooked up.
3. MENU button- Press to display the menu on the TV screen.
4. VOLUME ▲/▼ buttons- Press to control the volume level. Press to determine the setting mode from the menu on the TV screen. (only the VOL ▲ button) Press to select or adjust from a particular menu. (for example: Language Selection, Channel Presetting, Closed Caption Selection, Picture Adjustment, V-CHIP Set Up)

5. CHANNEL ▲/▼ buttons- Press to select memorized channel. **NOTE:** You MUST PRESET channels BEFORE using CHANNEL ▲/▼ buttons. (See CHANNEL PRESETTING.) Press to select the setting mode from the menu on the TV screen. Press to select item you want to adjust in the picture control mode.
6. POWER button- Press to turn the TV ON and OFF.
7. Infrared Sensor Window- Receives the infrared control signals from the remote control unit.
8. CHANNEL NUMBER buttons- Press two digits to directly access the desired channel. Remember to press a "0" before a single digit channel. +100 button- Press to select cable channels higher than 99.
9. MUTE button- Press the MUTE button to turn off the sound portion of the TV program. (Volume level display turns LIGHT RED from LIGHT BLUE.) Press the MUTE button again or press the VOL(ume) ▲ or ▼ button to restore sound.
10. INPUT SELECT button- Press to select TV or the external input (VIDEO1, VIDEO2, or COMPONENT) mode. (See USING AUDIO/VIDEO INPUT JACKS.)
11. CHANNEL RETURN button- Press this button to go back to the previously viewed channel. For example, pressing the CHANNEL RETURN button once will change channel display from CH 3 (present channel) to CH 10 (previously viewed channel), and pressing it a second time will return from CH 10 to CH 3.

- REAR PANEL -

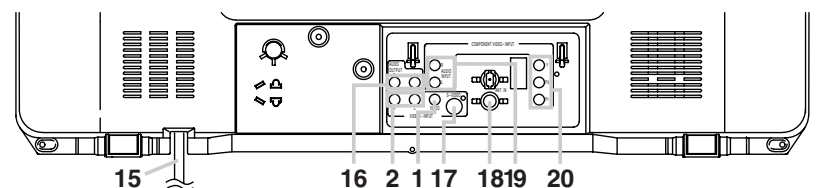

12. DISPLAY button- Press to display the channel number on the screen. If you press it again, the channel number will disappear.
13. SLEEP button- Press the SLEEP button to display the sleep timer and start the function. The shut off time can be determined by the number of times you press the button. (0, 10, 20, 30, 90, 0 minutes)
14. GAME button- Press to set the Game mode. To exit, press the INPUT SELECT button. (See USING AUDIO/VIDEO INPUT JACKS and PICTURE ADJUSTMENT.)
15. AC cord- Connect to a standard AC outlet (120V/60Hz). **NOTE:** Unwrap the AC cord completely from the backcover before plugging the cord into an AC outlet.
16. AUDIO L/R (out) jacks- Connect to the audio input of an external amplifier or decoder.
17. S-VIDEO input jack- Connect to the S-VIDEO output jack of a video camera or VCR using the S-VIDEO cable (not supplied). **NOTE:** The S-VIDEO jack on the rear panel is given priority over the VIDEO1 jack.
18. ANT(enna). IN jack- Connect to an antenna, cable system, or satellite system.
19. COMPONENT AUDIO INPUT jacks- Connect to the left/right channel audio output jacks of DVD player when using the Component Video input jacks.
20. COMPONENT VIDEO INPUT jacks- Connect to the Component Video output jacks of DVD player.

INSTALLING THE BATTERIES

- 1) Slide the battery compartment cover back on the remote unit.
- 2) Insert 2 "AA" penlight batteries into battery compartment in the direction as indicated by the polarity (+ / -) markings. Batteries installed with incorrect polarity may damage the remote unit.
- 3) Replace the cover.



USING AUDIO/VIDEO INPUT JACKS

When you use the AUDIO/VIDEO input jacks or COMPONENT VIDEO INPUT jacks, select "VIDEO1" or "VIDEO2" or "COMPONENT" mode by pressing the INPUT SELECT button on the remote control.

- To use the VIDEO1 INPUT jacks on the rear of the TV, select "VIDEO1".
- To use the jacks on the front of the TV, select "VIDEO2".
- To use the Component jacks on the rear of the TV, select "COMPONENT".

NOTES:

- You may also set the Game mode by pressing the GAME button on the remote control. "GAME" appears on the TV screen. In this case, connect the external source to the AUDIO/VIDEO jacks on the front panel. (See PICTURE ADJUSTMENT.)
- When you use the S-VIDEO connection, S-VIDEO jack on the rear panel is given priority over the VIDEO1 jack.

PREPARATION FOR USE

LANGUAGE SELECTION

If you want to change the language of the on-screen menu, follow the procedure below.

- 1) Connect the power cord to a standard AC outlet.
Note: If some digits appear in the corner of the screen, press the POWER button without unplugging the power cord.
- 2) Press the POWER button to turn on the TV.
- 3) Press the MENU button so that the menu display appears on the TV screen.
- 4) Press the CH(annel) ▲ or ▼ button to point to "[ENGLISH]".
- 5) Select "ENGLISH" or "ESPAÑOL" = Spanish by using the VOL(ume) ▲ or ▼ button.
- 6) Press the MENU button to exit the menu.

PICTURE CHANNEL SET [ENGLISH]ESPAÑOL V-CHIP SET UP CAPTION [OFF] TV SOUND [MAIN]

PICTURE CHANNEL SET [ENGLISH]ESPAÑOL V-CHIP SET UP CAPTION [OFF] TV SOUND [MAIN]

▶ ADD/DELETE AUTO MEMO

CHANNEL PRESETTING

NOTE: You MUST PRESET channels BEFORE using CHANNEL ▲ or ▼ button.

To preset a channel or to change a preset channel, follow the procedure below.

- 1) Press the POWER button to turn on the TV.
 - 2) Press the MENU button so that the menu display appears on the TV screen.
 - 3) Press the CH(annel) ▲ or ▼ button to point to "CHANNEL SET". Then, press the VOL(ume) ▲ button.
 - 4) Press the CH(annel) ▲ or ▼ button to point to "AUTO MEMO". Then, press the VOL(ume) ▲ button.
The tuner scans and memorizes all active channels in your area.
- The TV distinguishes between standard TV channels and cable (CATV) channels.
 - When AUTO MEMO action is completed, the lowest memorized channel reappears on the screen.
 - When you press the CH(annel) ▲ or ▼ button after selecting AUTO MEMO, the tuner will stop at the memorized channels only.
 - The TV may memorize TV channels as CATV channels if the reception conditions are poor. If this happens, try the AUTO MEMO action again when reception conditions are better.

PICTURE CHANNEL SET [ENGLISH]ESPAÑOL V-CHIP SET UP CAPTION [OFF] TV SOUND [MAIN]

ADD/DELETE AUTO MEMO

[ADD/DELETE FUNCTION]

- 1) Press the MENU button so that the menu display appears on the TV screen.
- 2) Press the CH(annel) ▲ or ▼ button to point to "CHANNEL SET". Then, press the VOL(ume) ▲ button.

PICTURE CHANNEL SET [ENGLISH]ESPAÑOL V-CHIP SET UP CAPTION [OFF] TV SOUND [MAIN]

OPERATIONS

WATCHING A TV PROGRAM

- 1) Press the POWER button to turn on the TV.
- 2) Select the desired channel with the CH(annel) ▲ or ▼ button.
- 3) Adjust the volume to the desired listening level using the VOL(ume) ▲ or ▼ button.
- 4) Adjust picture controls for a natural looking image. (See "PICTURE ADJUSTMENT".)

SETTING THE SLEEP TIMER

The sleep timer function allows you to have the POWER automatically turn off after a set time period.

- 1) Press the POWER button to turn on the TV and press the SLEEP button on the remote control.
- 2) You may change the sleep time by pressing the SLEEP button on the remote control repeatedly. The timer can be set up to 90 minutes, 10 minutes each time the SLEEP button is pushed. (The timer display counts up and sleep timer will be displayed on the screen when you press the SLEEP button on remote control.)

SLEEP 10

To cancel the sleep timer:
Press the SLEEP button repeatedly until "SLEEP 0" is displayed.

CLOSED CAPTION SELECTION

You may view specially labeled (cc) TV programs, movies, news, prerecorded tapes, etc. with either a dialogue caption or text display added to the program.

- 1) Press the MENU button so that the menu display appears on the TV screen.
- 2) Press the CH(annel) ▲ or ▼ button to point to "CAPTION".
- 3) Press the VOL(ume) ▲ or ▼ button to select the mode you wish.
- 4) When done, press the MENU button to exit the menu.

◀▶ : Press the VOL(ume) ▲ or ▼ button.

PICTURE CHANNEL SET [ENGLISH]ESPAÑOL V-CHIP SET UP CAPTION [OFF] TV SOUND [MAIN] ↔ PICTURE CHANNEL SET [ENGLISH]ESPAÑOL V-CHIP SET UP CAPTION [C1] TV SOUND [MAIN] ↔ PICTURE CHANNEL SET [ENGLISH]ESPAÑOL V-CHIP SET UP CAPTION [C2] TV SOUND [MAIN] ↔ PICTURE CHANNEL SET [ENGLISH]ESPAÑOL V-CHIP SET UP CAPTION [T1] TV SOUND [MAIN] ↔ PICTURE CHANNEL SET [ENGLISH]ESPAÑOL V-CHIP SET UP CAPTION [T2] TV SOUND [MAIN]

- 3) Press the VOL(ume) ▲ button so that "ADD/DELETE" is selected.

- 4) Use the CH(annel) ▲ or ▼ button to select the channel you wish to put into memory or to erase from memory.

Note: The display will return to the normal screen automatically in about 10 seconds.

- Perform "ADD/DELETE" function while this display appears on the screen.
 - Press the VOL(ume) ▲ or ▼ button to light up the channel number in LIGHT BLUE if you wish to add the channel into memory.
 - Press the VOL(ume) ▲ or ▼ button to light up the channel number in LIGHT RED if you wish to erase the channel from memory.
- 5) Press the MENU button to exit the menu.

MTS (Multi-Channel Television Sound) System

You can listen to a program in MTS stereo by following the steps below.

Menu Selection Type of broadcast	MAIN	MONO	SAP
Regular	-None-	-None-	-None-
Stereo broadcast	STEREO	MONO	STEREO
SAP	MAIN	MAIN	SAP

To show the status, press the DISPLAY button on the remote control.

SAP: Second Audio Program, which means your program, can also be received in a second language or sometimes a radio station.

[To Select STEREO, MONO or SAP in Stereo broadcast]

- 1) Press the MENU button so that the menu display appears on the TV screen.
- 2) Press the CH(annel) ▲ or ▼ button to point to "TV SOUND".
- 3) Press the VOL(ume) ▲ or ▼ button to select your desired stereo mode. ([MAIN], [MONO] or [SAP].)

◀▶ : Press the VOL(ume) ▲ or ▼ button.

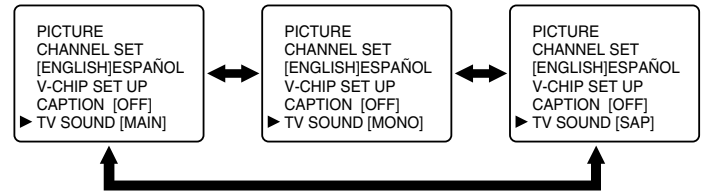

RESUME FUNCTION

If the power fails or is disconnected while the TV is powered on, the TV will turn on automatically when the power resumes.

PICTURE ADJUSTMENT

- 1) Press the MENU button so that the menu display appears on the TV screen.
- 2) Press the VOL(ume) ▲ button so that "PICTURE" is selected.
- 3) Select the feature you wish to adjust with the CH(annel) ▲ or ▼ button and adjust it with the VOL(ume) ▲ or ▼ button.

◀▶ : Press the CH(annel) ▲ or ▼ button.

	VOL(ume)▼	VOL(ume)▲
GAME MODE	OFF	ON
BRIGHT	to decrease brightness	to increase brightness
CONTRAST	to decrease contrast	to increase contrast
COLOR	to pale	to brilliant
TINT	to purple	to green
SHARPNESS	to soft	to clear

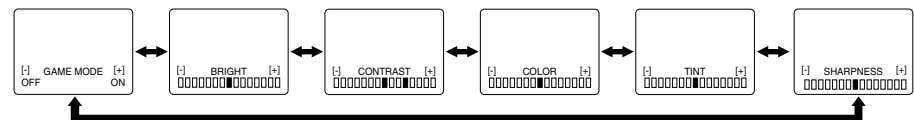

Note:

- In the above steps, the picture adjustment display will disappear from the TV screen automatically after about 10 seconds if you do not press any buttons. Press the MENU and VOL(ume) ▲ button so that "PICTURE" is selected. Then, press the CH(annel) ▲ or ▼ button repeatedly until the display returns to the screen.

[USING THE GAME BUTTON]

You can set the Game mode and front AUDIO/VIDEO input mode at the same time by pressing the GAME button on the remote control. "GAME" appears on the TV screen.

- To exit the Game mode and external input mode, press the INPUT SELECT button on the remote control.
- To cancel the Game mode only, adjust the Picture Control. In this case, "VIDEO2" instead of "GAME" appears on the TV screen.
- If you press the GAME button when the TV is off, the TV turns on and will be in the Game mode and external input mode automatically.

V-CHIP SET UP

V-CHIP enables parents to prevent their children from watching inappropriate material on TV. V-CHIP reads the ratings for programming (except for news and sports programs, unedited movies on premium cable channels, and Emergency Broadcast System signals), then denies access to programming if the program's rating meets or exceeds the limitations you select. In this case, "PROTECTED PROGRAM by ..." message appears on the TV screen.

To block certain ratings, follow the steps below.

- Programming may be rated by the Motion Picture Association of America (MPAA) or according to the Television Parental Guidelines. In order to block any inappropriate programming, set your limits in both places (MPAA RATING and TV RATING).
- You cannot access the menu when the "PROTECTED PROGRAM by ..." message appears. In this case, change to an unblocked channel, then press the MENU button.

[MPAA RATING SET UP]

- 1) Press the MENU button so that the menu display appears on the TV screen.
- 2) Press the CH(annel) ▲ or ▼ button to point to "V-CHIP SET UP". Then, press the VOL(ume) ▲ button.
- 3) Press the CH(annel) ▲ or ▼ button to point to "MPAA RATING". Then, press the VOL(ume) ▲ button.
- 4) Press the CH(annel) ▲ or ▼ button to point to your desired item. Then, press the VOL(ume) ▲ button to select [BLOCK] or [VIEW].

PICTURE CHANNEL SET [ENGLISH] ESPAÑOL
▶ V-CHIP SET UP [OFF]
CAPTION [OFF]
TV SOUND [MAIN]

TV RATING
▶ MPAA RATING

▶ G [VIEW]
PG [VIEW]
PG-13 [VIEW]
R [VIEW]
NC-17 [VIEW]
X [VIEW]

<Selection>	<Rating Category Explanations>
• G:	General Audience
• PG:	Parental Guidance suggested.
• PG-13:	Unsuitable for children under 13
• R:	Restricted; under 17 requires accompanying parent or adult guardian
• NC-17:	No one under 17 admitted
• X:	Mature audience only

- When you select the rating category and turn it to [BLOCK], the higher rating will turn [BLOCK] automatically. Also, the lower rating will turn [VIEW] automatically.
- When you turn "G" to [BLOCK] or [VIEW], the all ratings will turn to [BLOCK] or [VIEW] automatically.
- When you turn "X" to [VIEW], then all ratings will turn to [VIEW] automatically.

5) Press the MENU button to exit the menu.

[TV RATING SET UP]

- 1) Press the MENU button so that the menu display appears on the TV screen.
- 2) Press the CH(annel) ▲ or ▼ button to point to "V-CHIP SET UP". Then, press the VOL(ume) ▲ button.
- 3) Press the CH(annel) ▲ or ▼ button to point to "TV RATING". Then, press the VOL(ume) ▲ button.
- 4) Press the CH(annel) ▲ or ▼ button to point to your desired item. Then, press the VOL(ume) ▲ button to select [BLOCK] or [VIEW].

<Selection>	<Rating Category Explanations>
• TV-Y:	Appropriate for all children
• TV-Y7:	Appropriate for children seven and older
• TV-G:	General Audience
• TV-PG:	Parental Guidance suggested.
• TV-14:	Unsuitable for children under 14
• TV-MA:	Mature audience only

- When you select the rating category and turn it to [BLOCK], the higher rating will turn [BLOCK] automatically. Also, the lower rating will turn [VIEW] automatically.
- When you turn "TV-Y" to [BLOCK] or [VIEW], then all ratings will turn to [BLOCK] or [VIEW] automatically.
- When you turn "TV-MA" to [VIEW], then all ratings will turn to [VIEW] automatically.

When you select TV-Y7, TV-PG, TV-14, or TV-MA and you press the VOL(ume) ▲ button, the sub-ratings will appear on the TV screen.

If you select the rating category (example: TV-PG) and turn it to [BLOCK] or [VIEW], the sub-ratings (example: V for Violence) will turn [BLOCK] or [VIEW] automatically.

You can set the sub-ratings to [BLOCK] or [VIEW] individually when the rating category is set to [BLOCK]. To set the sub-ratings individually, follow the steps below.

• When you select [TV-Y7]:

Press the CH(annel) ▲ or ▼ button to select "FV" (Fantasy Violence). Then, press the VOL(ume) ▲ button to select [BLOCK] or [VIEW].

• When you select [TV-PG], [TV-14] or [TV-MA]:

Press the CH(annel) ▲ or ▼ button to select "D" (Suggestive Dialog), "L"(Coarse Language), "S"(Sexual Situation), or "V" (Violence). Then, press the VOL(ume) ▲ button to select [BLOCK] or [VIEW].

Notes:

- When you select [TV-MA], "D" does not appear on the TV screen.
- The sub-ratings which set to [BLOCK] appear next to the rating category in the TV RATING menu.

5) Press the MENU button to exit the menu.

PICTURE CHANNEL SET [ENGLISH] ESPAÑOL
▶ V-CHIP SET UP [OFF]
CAPTION [OFF]
TV SOUND [MAIN]

▶ TV RATING
MPAA RATING

▶ TV-Y [VIEW]
TV-Y7() [VIEW]
TV-G [VIEW]
TV-PG() [VIEW]
TV-14() [VIEW]
TV-MA() [VIEW]

TV-Y7 [BLOCK]
▶ FV [BLOCK]

TV-PG [BLOCK]
▶ D [BLOCK]
L [BLOCK]
S [BLOCK]
V [BLOCK]

▶ TV-Y [VIEW]
TV-Y7() [VIEW]
TV-G [BLOCK]
TV-PG(DLSV) [BLOCK]
TV-14(DLSV) [BLOCK]
TV-MA(LSV) [BLOCK]

TROUBLESHOOTING GUIDE

Sometimes a performance problem can be easily solved by checking seemingly apparent but often overlooked possibilities. Before arranging for service, check these items. It could save you time and money.

QUICK SERVICE CHECK LIST	PROBLEM	Remote Control Doesn't Work	Bars On Screen	Picture Distorted	Picture Rolls Vertically	No Color	Poor Reception on Some Channels	Weak Picture	Lines or Streaks in Picture	Ghosts in picture	Picture Blurred	Sound OK, Picture Poor	Picture OK, Sound Poor	No Picture or Sound	Different color marks on screen
Try a new channel, if OK, then possible station trouble.			X	X	X	X	X	X	X	X	X	X	X	X	X
Is TV plugged in? Power at outlet?		X												X	
Is TV's POWER button on?															X
Is antenna connected to terminal on the back of the set?						X	X	X		X	X	X	X	X	X
If outside antenna is being used, check for broken wire.			X	X	X	X	X	X	X	X	X	X	X	X	X
Check for local interference.		X	X	X	X	X	X	X	X	X	X	X	X	X	X
Turn off with POWER button and then turn it on after about a minute.															X
Adjust COLOR control.						X									
Adjust CONTRAST & BRIGHT control.								X				X			
Check batteries in Remote Control.		X													
Move the TV away from the nearby appliances which have Magnetism. Turn off using the POWER button, then turn it on again 30 minutes or so later.															X

Closed Caption Problem	Possible Remedy
My TV is showing captions that are misspelled.	You are watching a live broadcast and spelling errors made by the closed captioning production company may pass through uncorrected. A prerecorded program will not show any misspelled words because of the normal time available for editing the captions.
My TV will not show the text in its entirety or there is a delay of what is being said.	Captions that are delayed a few seconds behind the actual dialogue are common for live broadcasts. Most captioning production companies can display a dialogue to a maximum of 220 words per minute. If a dialogue exceeds that rate, selective editing is used to insure that the captions remain up-to-date with the current TV screen dialogue.
My captions are scrambled with white boxes on the TV screen.	Interference caused by building, power lines, thunderstorms, etc. may cause scrambled or incomplete captions to appear.
My program guide listed a TV show as being closed captioned but none of the captions were displayed.	Broadcasters may at times use a time compression process to the actual program so that additional advertising time can be given. Since the decoder cannot read the compressed information, captions will be lost.
My prerecorded videotape does not show any captions. The tape box mentions it being closed captioned.	The videotape was either an illegal copying or the tape duplicating company accidentally left out the captioning signals during the copying process.
My TV screen shows a black box on certain channels.	You are in the TEXT mode. Select CAPTION mode or CAPTION [OFF].

MAINTENANCE

CABINET CLEANING

- Wipe the front panel and other exterior surfaces of the TV with a soft cloth immersed in lukewarm water and wrung dry.
- Never use a solvent or alcohol. Do not spray insecticide liquid near the TV. Such chemicals may cause damage and discoloration to the exposed surfaces.

PICTURE TUBE CLEANING

Wipe the picture tube of the TV with a soft cloth. Before cleaning the picture tube, disconnect the power cord.

SUPPLIED ACCESSORIES

Remote control unit (NE122UD)



Owner's Manual (0EMN02197)

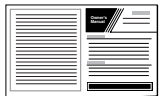

Batteries ("AA" x 2)



SPECIFICATIONS

GENERAL SPECIFICATIONS

Television system:	NTSC-M TV Standard
Closed Caption System:	\$15.119/FCC
Channel coverage	VHF: 2 ~ 13 UHF: 14 ~ 69 CATV: 2 ~ 13, A ~ W, W+1 ~ W+84, A-5 ~ A-1, 5A
Tuning System	181 channel frequency synthesized tuning system
Channel access:	Direct access keyboard, programmable scan and up/down
Terminals	
Antenna input:	VHF/UHF/CATV 75 ohm unbalanced (F-type)
S-Video input:	Mini DIN 4-pin jack
Video input:	RCA connector x 2
Audio input:	RCA connector x 6
Audio output:	RCA connector x 2
Component Video Input	
	One pin jack (Y) / Vpp (75 ohm)
	Two pin jack (Pb/Pk) / 700m Vpp (75 ohm)
Stereo Sound System	2 speakers

ELECTRICAL SPECIFICATIONS

Sound output: 3W, 8 ohm x2

OTHER SPECIFICATIONS

Remote control:	Digital encoded infrared light system
Operating temperature:	5°C to 40°C (41°F~104°F)
Power requirements:	AC120V, 60Hz
Power consumption (Maximum):	125W
Picture tube:	27"
Dimensions:	H: 24-5/16" (617mm) W: 27-1/16" (688mm) D: 19-7/8" (505mm)
Weight:	92.6 lbs. (42kg)

• Designs and specifications are subject to change without notice and without our legal obligation.
• If there is a discrepancy between languages, the default language will be English.

Free Manuals Download Website

<http://myh66.com>

<http://usermanuals.us>

<http://www.somanuals.com>

<http://www.4manuals.cc>

<http://www.manual-lib.com>

<http://www.404manual.com>

<http://www.luxmanual.com>

<http://aubethermostatmanual.com>

Golf course search by state

<http://golfingnear.com>

Email search by domain

<http://emailbydomain.com>

Auto manuals search

<http://auto.somanuals.com>

TV manuals search

<http://tv.somanuals.com>