

# SYLVANIA

## 13" Digital / Analog Television

Owner's Manual

# CR130SL8

INTRODUCTION

CONNECTION

INITIAL SETTING

WATCHING TV

OPTIONAL SETTING

TROUBLESHOOTING

INFORMATION



**TO RECEIVE DIGITAL/ANALOG SIGNAL,  
YOU MUST CONNECT ANTENNA.**



IF YOU NEED ADDITIONAL ASSISTANCE WITH SETUP OR OPERATING AFTER  
READING OWNER'S MANUAL, PLEASE CALL TOLL FREE **1-800-968-3429**, OR  
VISIT OUR WEB SITE AT **<http://www.SylvaniaConsumerElectronics.com>**

**WARNING: TO REDUCE THE RISK OF FIRE OR ELECTRIC SHOCK, DO NOT EXPOSE THIS APPLIANCE TO RAIN OR MOISTURE.**



**CAUTION**  
**RISK OF ELECTRIC SHOCK**  
**DO NOT OPEN**



**CAUTION:** TO REDUCE THE RISK OF ELECTRIC SHOCK, DO NOT REMOVE COVER (OR BACK). NO USER SERVICEABLE PARTS INSIDE. REFER SERVICING TO QUALIFIED SERVICE PERSONNEL.



THIS SYMBOL INDICATES THAT DANGEROUS VOLTAGE CONSTITUTING A RISK OF ELECTRIC SHOCK IS PRESENT WITHIN THIS UNIT.



THIS SYMBOL INDICATES THAT THERE ARE IMPORTANT OPERATING AND MAINTENANCE INSTRUCTIONS IN THE LITERATURE ACCOMPANYING THE APPLIANCE.

The important note is located on the rear of the cabinet.

## Important Safeguards

- 1. READ INSTRUCTIONS** - All the safety and operating instructions should be read before the appliance is operated.
- 2. RETAIN INSTRUCTIONS** - The safety and operating instructions should be retained for future reference.
- 3. HEED WARNINGS** - All warnings on the appliance and in the operating instructions should be adhered to.
- 4. FOLLOW INSTRUCTIONS** - All operating and use instructions should be followed.
- 5. CLEANING** - Unplug TV from the wall outlet before cleaning. Do not use liquid cleaners or aerosol cleaners. Use a damp cloth for cleaning.  
EXCEPTION: A product that is meant for uninterrupted service and, that for some specific reason, such as the possibility of the loss of an authorization code for a CATV converter, is not intended to be unplugged by the user for cleaning or any other purpose, may exclude the reference to unplugging the appliance in the cleaning description otherwise required in item 5.
- 6. ATTACHMENTS** - Do not use attachments not recommended by the TV manufacturer as they may cause hazards.
- 7. WATER AND MOISTURE** - Do not use this TV near water, for example, near a bath tub, wash bowl, kitchen sink, or laundry tub, in a wet basement, or near a swimming pool, and the like.
- 8. ACCESSORIES** - Do not place this TV on an unstable cart, stand, tripod, bracket, or table. The TV may fall, causing serious injury to someone, and serious damage to the appliance. Use only with a cart, stand, tripod, bracket, or table recommended by the manufacturer, or sold with the TV.  
Any mounting of the appliance should follow the manufacturer's instructions and should use a mounting accessory recommended by the manufacturer. An appliance and cart combination should be moved with care. Quick stops, excessive force, and uneven surfaces may cause the appliance and cart combination to overturn.  
**AMEUBLES** - Cet appareil ne doit être placé que sur un meuble (avec ou sans roulettes) recommandé par le fabricant. Si vous l'installez sur un meuble à roulettes, déplacez les deux ensembles avec précaution. Un arrêt brusque, l'utilisation d'une force excessive et des surfaces irrégulières risquent de déstabiliser l'ensemble et de le renverser.
- 9. VENTILATION** - Slots and openings in the cabinet and the back or bottom are provided for ventilation and to ensure reliable operation of the TV and to protect it from overheating, these openings must not be blocked or covered. The openings should never be blocked by placing the TV on a bed, sofa, rug, or other similar surface. This TV should never be placed near or over a radiator or heat register. This TV should not be placed in a built-in installation such as a bookcase or rack unless proper ventilation is provided or the manufacturer's instructions have been adhered to.
- 10. POWER SOURCES** - This TV should be operated only from the type of power source indicated on the marking label. If you are not sure of the type of power supply to your home, consult your appliance dealer or local power company. For TVs intended to operate from battery power, or other sources, refer to the operating instructions.



- 11. GROUNDING OR POLARIZATION** - This TV is equipped with a polarized alternating-current line plug (a plug having one blade wider than the other). This plug will fit into the power outlet only one way. This is a safety feature. If you are unable to insert the plug fully into the outlet, try reversing the plug. If the plug should still fail to fit, contact your electrician to replace your obsolete outlet. Do not defeat the safety purpose of the polarized plug.
- 12. POWER-CORD PROTECTION** - Power-supply cords should be routed so that they are not likely to be walked on or pinched by items placed upon or against them, paying particular attention to cords at plugs, convenience receptacles, and the point where they exit from the appliance.
- 13. OUTDOOR ANTENNA GROUNDING** - If an outside antenna or cable system is connected to the TV, be sure the antenna or cable system is grounded so as to provide some protection against voltage surges and built-up static charges. Article 810 of the National Electrical Code, ANSI/NFPA No. 70, provides information with respect to proper grounding of the mast and supporting structure, grounding of the lead-in wire to an antenna discharge unit, size of grounding conductors, location of antenna-discharge unit, connection to grounding electrodes, and requirements for the grounding electrode. (Fig. A)

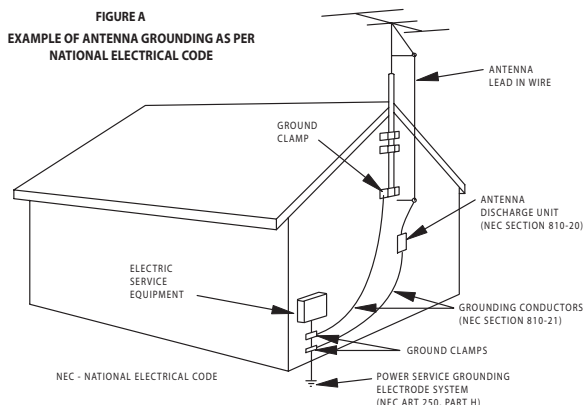

- 14. LIGHTNING** - For added protection for this TV receiver during a lightning storm, or when it is left unattended and unused for long periods of time, unplug it from the wall outlet and disconnect the antenna or cable system. This will prevent damage to the TV due to lightning and power-line surges.
- 15. POWER LINES** - An outside antenna system should not be located in the vicinity of overhead power lines or other electric light of power circuits, or where it can fall into such power lines or circuits. When installing an outside antenna system, extreme care should be taken to keep from touching such power lines or circuits as contact with them might be fatal.
- 16. OVERLOADING** - Do not overload wall outlets and extension cords as this can result in a risk of fire or electric shock.

- 17. OBJECT AND LIQUID ENTRY** - Never push objects of any kind into this TV through openings as they may touch dangerous voltage points or short out parts that could result in a fire or electric shock. Never spill liquid of any kind on the TV.
- 18. SERVICING** - Do not attempt to service this TV yourself as opening or removing covers may expose you to dangerous voltage or other hazards. Refer all servicing to qualified service personnel.
- 19. DAMAGE REQUIRING SERVICE** - Unplug this TV from the wall outlet and refer servicing to qualified service personnel under the following conditions:
- When the power supply cord or plug is damaged or frayed.
  - If liquid has been spilled, or objects have fallen into the TV.
  - If the TV has been exposed to rain or water.
  - If the TV does not operate normally by following the operating instructions. Adjust only those controls that are covered by the operating instructions, as improper adjustment of other controls may result in damage and will often require extensive work by a qualified technician to restore the TV to its normal operation.
  - If the TV has been dropped or damaged in any way.
  - When the TV exhibits a distinct change in performance, this indicates a need for service.
- 20. REPLACEMENT PARTS** - When replacement parts are required, be sure the service technician uses replacement parts specified by the manufacturer that have the same characteristics as the original part. Unauthorized substitutions may result in fire, electric shock, injury to persons or other hazards.
- 21. SAFETY CHECK** - Upon completion of any service or repairs to this TV, ask the service technician to perform routine safety checks to determine that the TV is in proper operating condition.
- 22. HEAT** - This TV product should be situated away from heat sources such as radiators, heat registers, stoves, or other products (including amplifiers) that produce heat.

## ☑ Precautions

<b>CAUTION:</b>	TO PREVENT ELECTRIC SHOCK, MATCH WIDE BLADE OF PLUG TO WIDE SLOT, FULLY INSERT.
<b>ATTENTION:</b>	POUR ÉVITER LES CHOCS ÉLECTRIQUES, INTRODUIRE LA LAME LA PLUS LARGE DE LA FICHE DANS LA BORNE CORRESPONDANTE DE LA PRISE ET POUSSER JUSQU'AU FOND.

<b>FCC WARNING</b>	This equipment may generate or use radio frequency energy. Changes or modifications to this equipment may cause harmful interference unless the modifications are expressly approved in the manual. The user could lose the authority to operate this equipment if an unauthorized change or modification is made.
--------------------	--

## RADIO-TV INTERFERENCE

This equipment has been tested and found to comply with the limits for a Class B digital device, pursuant to Part 15 of the FCC Rules. These limits are designed to provide reasonable protection against harmful interference in a residential installation. This equipment generates, uses, and can radiate radio frequency energy and, if not installed and used in accordance with the instructions, may cause harmful interference to radio communications. However, there is no guarantee that interference will not occur in a particular installation. If this equipment does cause harmful interference to radio or television reception, which can be determined by turning the equipment off and on, the user is encouraged to try to correct the interference by one or more of the following measures:

- 1) Reorient or relocate the receiving antenna.
- 2) Increase the separation between the equipment and receiver.
- 3) Connect the equipment into an outlet on a circuit different from that to which the receiver is connected.
- 4) Consult the dealer or an experienced radio/TV technician for help.

**This Class B digital apparatus complies with Canadian ICES-003.**

**Cet appareil numérique de la classe B est conforme à la norme NMB-003 du Canada.**

### **Note to CATV system installer:**

*This reminder is provided to call the CATV system installer's attention to Article 820-40 of the NEC that provides guidelines for proper grounding and, in particular, specifies that the cable ground should be connected to the grounding system of the building as close to the point of cable entry as practical.*



**Manufactured under license from Dolby Laboratories. "Dolby" and the double-D symbol are trademarks of Dolby Laboratories.**

## LOCATION

For safe operation and satisfactory performance of the unit, keep the following in mind when selecting a place for its installation:

- Shield it from direct sunlight and keep it away from sources of intense heat.
- Avoid dusty or humid places.
- Avoid places with insufficient ventilation for proper heat dissipation. Do not block the ventilation holes at the top and bottom of the unit. Do not place the unit on a carpet because this will block the ventilation holes.
- Install the unit in a horizontal position.
- Avoid locations subject to strong vibration.
- Do not place the unit near strong magnetic fields.
- Avoid moving the unit to locations where temperature differences are extreme.
- Be sure to unplug the AC power cord from the outlet before carrying the unit.

## TO AVOID THE HAZARDS OF ELECTRICAL SHOCK AND FIRE

- Do not handle the power cord with wet hands.
- Do not pull on the power cord when disconnecting it from an AC outlet. Grasp it by the plug.
- If, by accident, water is spilled on the unit, unplug the power cord immediately and take the unit to our authorized service center for servicing.
- Do not place anything directly on top of the unit.

The serial number of this product may be found on the back of the unit. No others have the same serial number as yours. You should record the number and other vital information here and retain this book as a permanent record of your purchase to aid identification in case of theft.

date of purchase	dealer phone No.	serial No.
dealer purchase from	model No.	dealer address

### Note about recycling:

*This product's packaging materials are recyclable and can be reused. Please dispose of any materials in accordance with your local recycling regulations.*

*Batteries should never be thrown away or incinerated but disposed of in accordance with your local regulations concerning chemical wastes.*

## ✓ Supplied Accessories

owner's manual  
(1EMN22134)



remote control  
(NE601UE)



batteries  
(AA x 2)

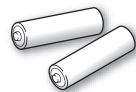

- If you need to replace these accessories, please refer to the part No. with the illustrations and call our toll free customer support line found on the cover of this manual.
- Depending on your antenna system, you may need different types of combiners (mixers) or separators (splitters). Contact your local electronics store for these items.

## ✓ Symbols Used in this Manual

The following is the description for the symbols used in this manual.

Description refers to:

**DTV** : Digital TV operation

**TV** : Analog TV operation

- If neither symbol appears under the function heading, operation is applicable to both.

## ✓ Features

- **DTV/TV/CATV**
  - You can use your remote control to select channels which are broadcast in digital, conventional analog, standard definition, and high definition formats. Also, cable subscribers can access their cable TV channels.
- **Program Information Display (DTV only)**
  - You can display the title, contents and other information of the current DTV program on the TV screen.
- **Auto Channel Scan**
  - This unit automatically scans and memorizes channels available in your area, eliminating difficult setup procedures.
- **V-chip**
  - This feature allows you to block children's access to inappropriate programs.
- **Closed Caption Decoder**
  - Built-in closed caption decoder displays text for closed caption supported programming.
- **Auto Shut Off Function**
  - If there is no signal input from the antenna terminal and no operation for 15 minutes, the unit will turn itself off automatically.
- **Sleep Timer**
  - This feature will automatically turned off the power of the unit at a specific time.
- **Choices for On-screen Language**
  - Select your on-screen language: English, Spanish or French.
- **PLL Frequency Synthesized Tuning**
  - Provides free and easy channel selection and lets you tune directly to any channel using the channel number buttons on the remote control.
- **AV Input**
- **Digital Audio Coaxial Output**

## ✓ Contents

### INTRODUCTION

Important Safeguards .....	2
Precautions .....	3
Supplied Accessories .....	4
Symbols Used in this Manual .....	4
Features .....	5
Remote Control Function .....	6
Installing the Batteries .....	6
Control Panel .....	7
Rear Panel .....	7

### CONNECTION

Basic Connection .....	8
External Device Connection .....	9

### INITIAL SETTING

Initial Setup .....	10
Main Menu .....	10
Auto Channel Scan .....	11
Language Selection .....	11

### WATCHING TV

Channel Selection .....	12
Volume Adjustment .....	12
Switching Digital / Analog Mode .....	13
Accessing External Devices .....	13
Screen Information .....	13
TV Screen Display Mode .....	14
Sleep Timer .....	14

### OPTIONAL SETTING

Channel Add/Delete .....	15
Picture Adjustment .....	16
Closed Caption .....	16
DTV Closed Caption .....	17
DTVCC Style .....	18
V-chip .....	19

### TROUBLESHOOTING

Troubleshooting Guide .....	22
Maintenance .....	23

### INFORMATION

Glossary .....	24
Cable Channel Designations .....	24
General Specifications .....	24
Electrical Specification .....	24
Other Specifications .....	24

Limited Warranty .....	Back cover
------------------------	------------

## ✓ Remote Control Function

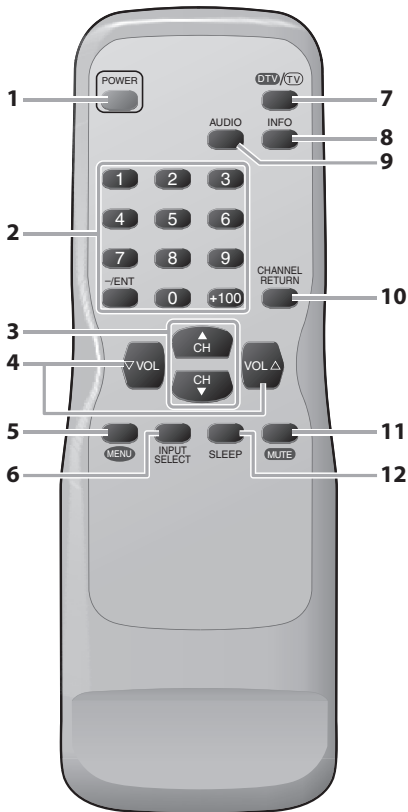

1. **POWER button** (p10)  
Press to turn the unit on and off.
2. **Number buttons** (p12)  
• Press to select channels.  
• Press to shift the minor channel from the major channel.  
**-/ENT button**  
• Press to select 100 or higher channels. (CATV)  
**+100 button**  
• Press to search if there are minor channels on the currently selected major channel. (DTV)
3. **CH ▲/▼ buttons** (p12)  
Press to select channels and the external input mode or move up/down through the main menu items.
4. **VOL ▲/▼ buttons** (p12)  
Press to adjust the volume or move right(▲)/left(▼) through the main menu items.
5. **MENU button** (p10)  
Press to display the main menu.
6. **INPUT SELECT button** (p13)  
Press to access a connected external device like a DVD player or a VCR.
7. **DTV/TV button** (p13)  
Press to switch between the digital mode (DTV) and analog mode (TV).
8. **INFO button** (p13)  
**Digital Mode (DTV)**  
• Press to display channel number and program information.  
**Analog Mode (TV)**  
• Press to display the channel number.
9. **AUDIO button** (p13)  
**Digital Mode (DTV only)**  
Press to select the audio language.
10. **CHANNEL RETURN button** (p12)  
Press to return to previous channel.
11. **MUTE button** (p12)  
Press to turn the sound on and off.
12. **SLEEP button** (p14)  
Press to activate the sleep timer.

## ✓ Installing the Batteries

Install the batteries (AA x 2) matching the polarity indicated inside battery compartment of the remote control.

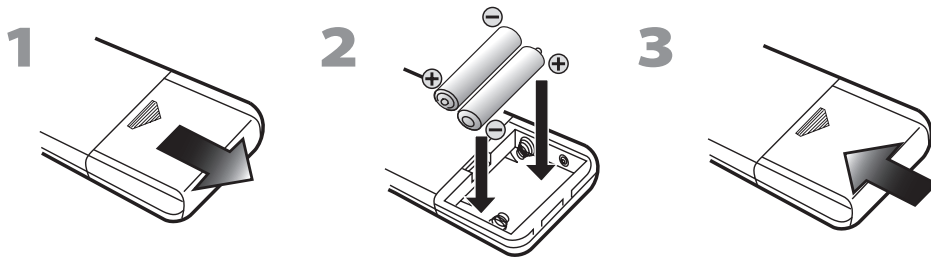

### Battery Precautions:

- Be sure to follow the correct polarity as indicated in the battery compartment. Reversed batteries may cause damage to the device.
- Do not mix different types of batteries together (e.g., Alkaline and Carbon-Zinc) or old batteries with fresh ones.
- If the device is not to be used for a long period of time, remove the batteries to prevent damage or injury from possible battery leakage.
- Do not try to recharge batteries; they can overheat and rupture.

## ✓ Control Panel

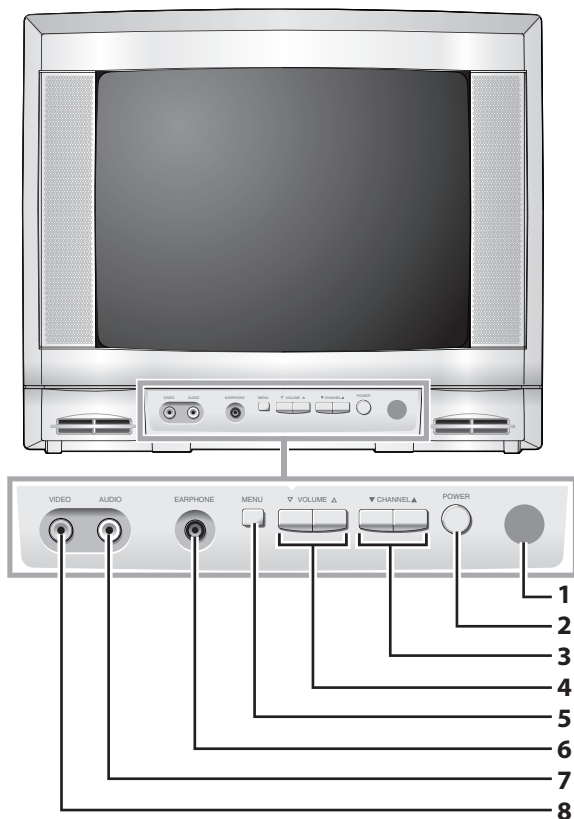

1. **Infrared Sensor Window**  
Receives infrared rays transmitted from the remote control.
2. **POWER button** (p10)  
Press to turn the unit on and off.
3. **CHANNEL ▲/▼ buttons** (p12)  
Press to select channels or move up/down through the main menu items.
4. **VOLUME ▲/▼ buttons** (p12)  
Press to adjust the volume or move right(▲)/left(▼) through the main menu items.
5. **MENU button** (p10)  
Press to display the main menu.
6. **EARPHONE jack**  
Earphone connection for personal listening.
7. **AUDIO (L) input jack** (p9)  
RCA audio cable connection for an external device.
8. **VIDEO input jack** (p9)  
RCA video cable connection for an external device.

## ✓ Rear Panel

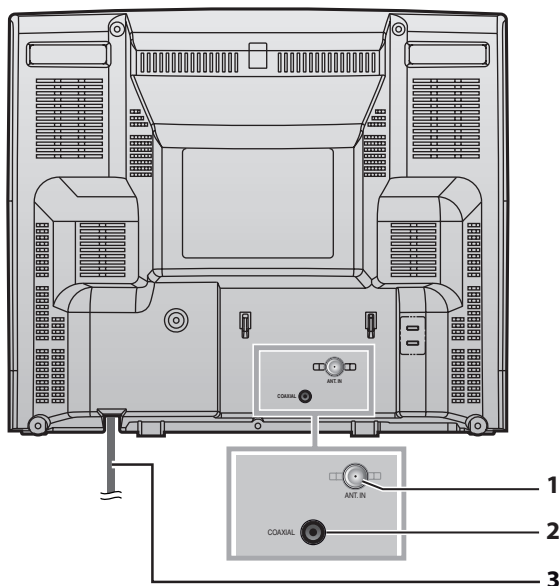

1. **ANT. IN jack** (p8)  
RF coaxial cable connection for your antenna or cable/satellite box.
2. **COAXIAL (digital audio) output jack** (p9)  
Digital audio coaxial cable connection for a decoder or an audio receiver.  
Use digital audio input jack of an external device.
3. **AC power cord**  
Connect to a standard AC outlet to supply power to this unit.

## Cables not included.

Please purchase the necessary cables at your local store.

### ✓ Basic Connection

This section describes how to connect the unit to an antenna, cable/satellite box, etc.

#### Note:

- Be sure your antenna or other device is connected properly before plugging in the power cord.

#### [Antenna Cable Connection]

When connecting the unit to an antenna or cable TV company (without cable/satellite box)

Connect the RF coaxial cable on your home outlet to the antenna input jack of this unit.

e.g.)

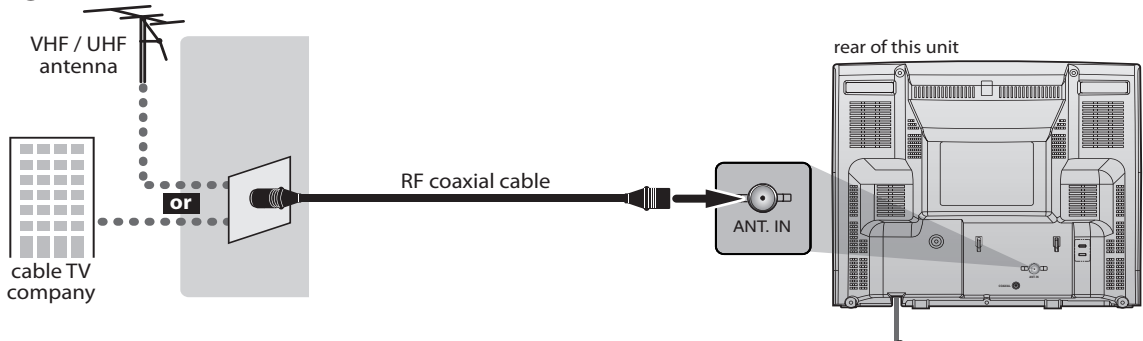

\*Once connections are completed, turn on the unit and begin initial setup.

Channel scanning is necessary for the unit to memorize all available channels in your area.

(Refer to "Initial Setup" on page 10.)

#### Note:

- For your safety and to avoid damage to device, please unplug the RF coaxial cable from the antenna input jack before moving the unit.
- If you use an antenna to receive analog TV, it should also work for DTV reception. Outdoor or attic antennas will be more effective than set-top versions.
- To easily switch your reception source between antenna and cable, install an antenna selector.
- If you connect to the cable system directly, contact the CATV installer.

#### [Connection to Cable Box or Satellite Box]

Connect the RF coaxial cable on your home outlet to the input jack of the cable/satellite box.

Use another RF coaxial cable to connect the antenna input jack of the unit to the output jack of the cable/satellite box.

e.g.)

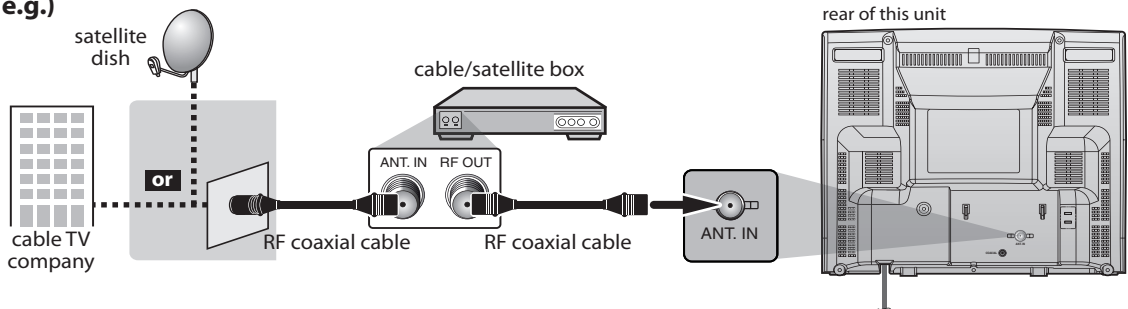

\*Required cables and connecting methods differ depending on the cable/satellite box.

For more information, please contact your cable/satellite provider.



**Cables not included.**

Please purchase the necessary cables at your local store.

**External Device Connection****[Video Connection]**

Video connection offers standard picture quality for video devices connected to the unit. Make the connection as illustrated below.

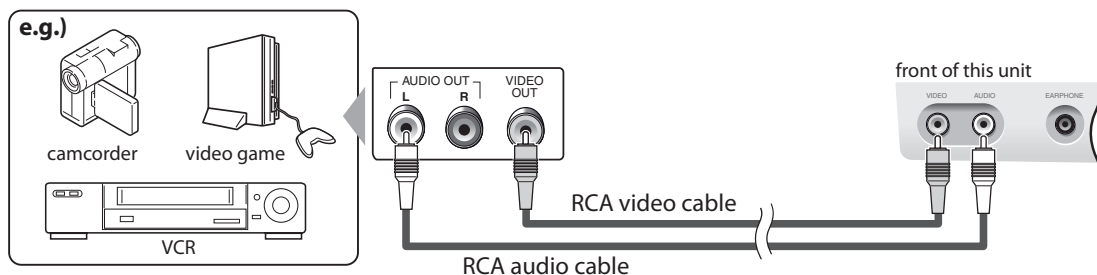
**[Digital Audio Output Connection]**

If you connect this unit to an external digital audio device, you can enjoy multi-channel audio like 5.1ch digital broadcasting sound.

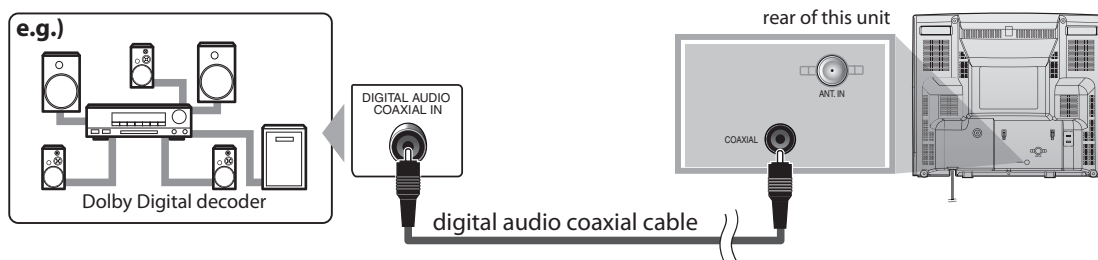

*These operations are accessible by remote control. Some may also be accessible by controls on the main unit.*

## ✓ Initial Setup

This section will guide you through the unit's initial setting which includes selecting a language for your on-screen menu and "AUTO PRESET CH", which automatically scans and memorizes viewable channels.

### Before you begin:

Make sure if the unit is connected to antenna or cable.

- 1 After making all the necessary connections, press **[POWER]** to turn on the unit.



- This operation may take a few moments.

- 2 Use **[CH ▲/▼]** or **[VOL ▲]** to select the on-screen language from the choices on the left side of the TV screen. (ENGLISH / ESPAÑOL / FRANÇAIS)

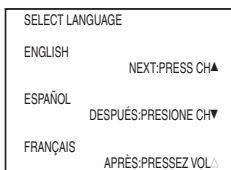

- Press **[CH ▲]** for English.
- Press **[CH ▼]** for Spanish.
- Press **[VOL ▲]** for French.

- 3 Use **[CH ▲/▼]** to select "AUTO PRESET CH(TV/DTV)" for TV channels or "AUTO PRESET CH(CATV)" for CATV channels, then press **[VOL ▲]**.

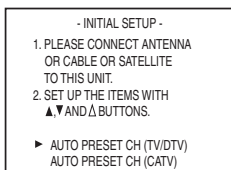

- Scanning and memorizing the channels automatically start.

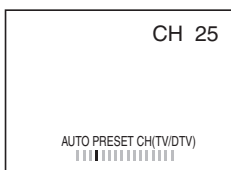

- When the scanning and memorizing are completed, the lowest memorized channel in the broadcasting will be displayed.

### Note:

- If you connect the cable system directly, contact the CATV installer.
- If you press **[POWER]** or **[MENU]** during "AUTO PRESET CH", this setting will be canceled.
- The initial auto channel scan function can be executed for either TV/DTV or CATV only once. If you want to scan both TV/DTV and CATV, you need to select "CHANNEL SETUP" in the main menu to scan and memorize other channels after initial presetting is completed. (Refer to page 11.)
- You can cancel or exit the initial "AUTO PRESET CH" menu by pressing **[MENU]**.
- When no channel can be received by "AUTO PRESET CH", "NO TV SIGNALS" is displayed on the TV screen.
- If there is no signal input from the antenna terminal and no operation for more than few seconds, "HELPFUL HINTS" appears. Follow the instructions listed on the TV screen.

- HELPFUL HINTS -  
 1. PLEASE CHECK TO SEE IF THE ANTENNA / CABLE / SATELLITE IS PROPERLY CONNECTED.  
 2. DID YOU PERFORM "AUTO PRESET CH"?  
 3. PLEASE REFER TO FRONT PAGE OF THE OWNER'S MANUAL OR REAR PANEL FOR SUPPORT LINE INFORMATION.

## ✓ Main Menu

This section describes the overview of the main menu displayed when you press **[MENU]**.

For more details, see the reference page for each item.

The main menu consists of the function setting items below.

Press **[MENU]** to display the main menu.

e.g.) digital TV mode

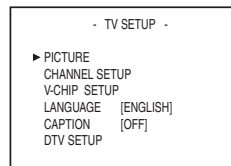

### • PICTURE

You can adjust the picture quality. (Refer to "Picture Adjustment" on page 16.)

### • CHANNEL SETUP

You can automatically scan the viewable channels and remove those that are undesired. (Refer to "Auto Channel Scan" on page 11.)

### • V-CHIP SETUP

You can set the viewing limitations. (Refer to "V-chip" on page 19.)

### • LANGUAGE

You can change the language (English, Spanish, French) displayed on the main menu. (Refer to "Language Selection" on page 11.)

### • CAPTION

You can change the display format for closed caption, which displays the dialogue of a TV program or other information across the TV screen. (Refer to "Closed Caption" on page 16.)

### • DTV SETUP

You can set the screen display or caption in the DTV mode. (Refer to "DTV Closed Caption" on page 17.)

## ✓ Auto Channel Scan

If you switch wires (e.g., between antenna and CATV) or if you move the TV to a different area after the initial setting, or if you recover the DTV channel you deleted, you will need to perform auto channel scan.

### Before you begin:

Make sure if the unit is connected to antenna or cable.

1 Press [MENU] to display the main menu.



2 Use [CH ▲/▼] to select "CHANNEL SETUP", then press [VOL ▲].



e.g.) digital TV mode

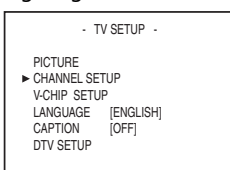

3 Use [CH ▲/▼] to select your desired preset type, then press [VOL ▲].



e.g.) digital TV mode

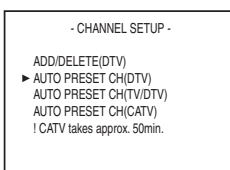

- When aerial antenna is connected, select "AUTO PRESET CH (TV)", "AUTO PRESET CH (DTV)" or "AUTO PRESET CH (TV/DTV)".
- When connected to CATV, select "AUTO PRESET CH (CATV)".
- Scanning and memorizing the channels automatically start.

e.g.) digital TV mode

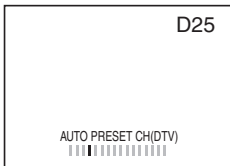

- When the scanning and memorizing are completed, the lowest memorized channel will be displayed.
- When you selected "AUTO PRESET CH (TV/DTV)", the lowest memorized analog channel will be displayed when the scanning and memorizing are completed. If there is no analog channel, the lowest memorized digital channel will be displayed.

### Note:

- If you connect the cable system directly, contact the CATV installer.
- If you press [POWER] or [MENU] during "AUTO PRESET CH", the setting will be canceled.
- When no channel can be received by "AUTO PRESET CH", "NO TV SIGNALS" is displayed on the TV screen.
- Channel setting will be saved even if the power fails.
- If you have Spanish or French menus and need English, press [MENU]. Use [CH ▲/▼] to select "IDIOMA" or "LANGAGE". Press [VOL ▲] to select "ENGLISH". Press [MENU] to remove the main menu.
- With regard only to the digital channel, even after the scanning is complete if you unplug the AC power cord before turning off the unit by pressing [POWER], the channel setting may be lost.

## ✓ Language Selection

You can choose English, Spanish, or French as your on-screen language.

1 Press [MENU] to display the main menu.



2 Use [CH ▲/▼] to select "LANGUAGE", then press [VOL ▲] repeatedly to change the setting.



e.g.) digital TV mode

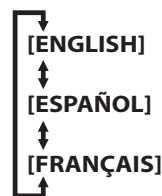
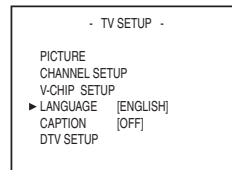

3 Press [MENU] to exit.



## ✓ Channel Selection

Select channels by pressing [CH ▲/▼] or [the Number buttons].

- To select the memorized channels, use [CH ▲/▼] or [the Number buttons].
- To select the non-memorized channels, use [the Number buttons].

### To use [the Number buttons]

**TV**

- When selecting analog channel 12

1 → 2

**DTV**

- When selecting digital channel 12-1

Be sure to press [-/ENT] before entering the minor channel number.

1 → 2 → [-/ENT] → 1

- Press [CHANNEL RETURN] to return to the previously viewed channel.
- When you select a channel larger than 100, press [+100] first. Then use [the Number buttons] to press the lower 2-digit numbers.

### About digital TV broadcasting:

With its high definition broadcast, digital broadcasting far surpasses analog broadcasting in both its picture and sound quality.

### What is the minor channel?

By using high compression technology, digital broadcasting offers a service that enables multiple signals to send simultaneously. Therefore, you can select more than one program per major channel since digital broadcasting technology distinguishes between multiple channels broadcast by a single network.

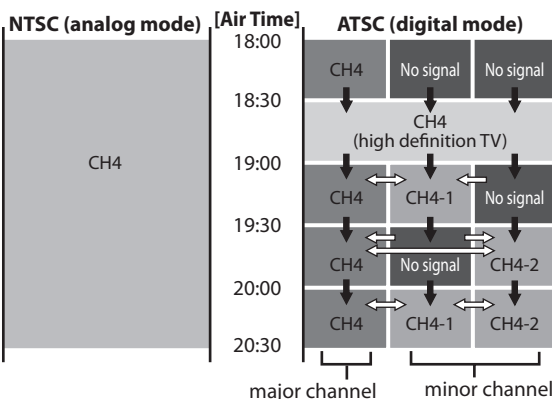

➡ : change automatically

↔ : change manually by using [CH▲/▼]

Although, you cannot watch the high definition TV (HDTV) program, the unit converts the HDTV signal down to the standard definition TV signal.

### Note:

- "NO SIGNAL" will appear on the TV screen after the minor channel broadcast is over.

## ✓ Volume Adjustment

This section describes how to adjust the volume.

The mute function, which turns the sound off and on, is also described.

Use [VOL ▲/▼] to adjust the audio volume.



- The volume bar will be displayed at the bottom of the TV screen when adjusting the volume.
- The volume bar display will automatically disappear in a few seconds.

Press [MUTE] to turn off and on the sound.

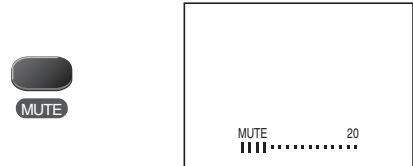

- "MUTE" is displayed on the TV screen for a few seconds.

Press [MUTE] again or [VOL ▲/▼] to recover the original volume.

## ✓ Switching Digital / Analog Mode

You can easily switch the DTV (ATSC) and TV (NTSC) with the remote control and enjoy viewing the TV programs with simple operation.

Press **[DTV/TV]** repeatedly to change the input mode.



### Note:

- When you switch the analog mode to the digital mode, it may take a while until the digital channel selection is completed. The following message is displayed while switching the mode.



## ✓ Accessing External Devices

Use your remote control to access an external device when they are connected to the unit.

Press **[INPUT SELECT]** repeatedly to cycle through analog TV, digital TV and VIDEO.



- To use the video input jack on the front of the unit, select "VIDEO".

## ✓ Screen Information

You can display the currently selected channel or other information such as the audio mode on the TV screen.

**TV**

In the analog mode, the current channel number is displayed.

Press **[INFO]**.

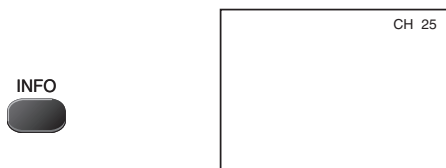

- The current channel number is displayed at the top-right corner of the TV screen.
- To clear the display, press **[INFO]** again.

**DTV**

In the digital mode, the detailed broadcasting information for the current channel such as program title, the program guides are displayed.

Press **[INFO]** repeatedly to cycle through the available display modes.

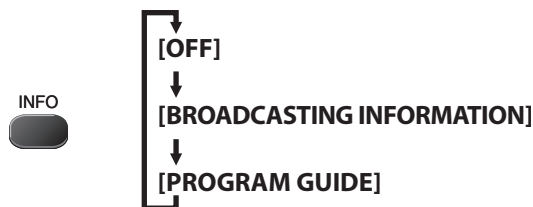

### [Broadcasting Information]

- The following information is displayed.

- 1 channel number
- 2 broadcast station
- 3 program title
- 4 audio language

Press **[AUDIO]** repeatedly to cycle through the available audio languages.

("OTHER" is displayed when the audio language cannot be acquired, or the acquired languages are other than English, Spanish or French.)

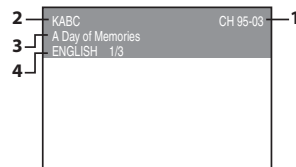

### [Program Guide]

- The program guide added to broadcasting information is displayed.

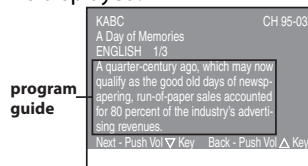

### Note:

- When the program guide consists of more than 6 lines, use **[VOL ▲/▾]** to scroll.
- "No description provided" is displayed when the program guide is not provided.
- While the program guide is displayed, the closed caption function is interrupted.
- In external input mode, the following screen is displayed; e.g.) When an external device is connected to VIDEO input jack.



- Available languages differ depending on the broadcast.
- The information display will automatically disappear in 1 minute.
- Pressing **[AUDIO]** does not control external audio source.

## ✓ TV Screen Display Mode

2 types of display modes can be selected in the digital mode.

DTV

1 Press **[MENU]** to display the main menu.



2 Use **[CH ▲/▼]** to select "DTV SETUP", then press **[VOL ▲]**.



e.g.) digital TV mode

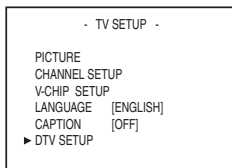

3 Use **[CH ▲/▼]** to select "DTV DISPLAY", then use **[VOL ▲/▼]** to switch the desired TV aspect ratio.

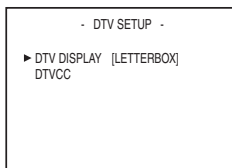
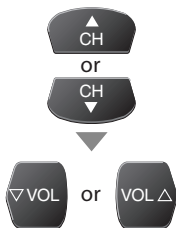

LETTERBOX

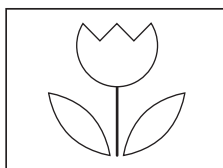

ZOOM

### [LETTERBOX]

Display the digital-supported program in full-screen. Black borders will spread in the upper and lower screen.

### [ZOOM]

Enlarge and display the center area of the digital-supported program.

The right and left side of image will be cut off.

4 Press **[MENU]** to exit.



### Note:

- You may not switch the display mode depending on the program.

## ✓ Sleep Timer

The sleep timer can be set to automatically turn off the unit after an incremental period of time.

1 Press **[SLEEP]** to set the sleep timer.

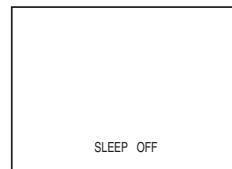

- Sleep timer display appears on the TV screen.

2 Press **[SLEEP]** repeatedly to change the amount of time until shut off.



- You can set the unit to turn off after a set period of time (from 30 to 120 minutes).
- Each press of **[SLEEP]** will increase the time by 30 minutes.
- After set up, the sleep timer display can be called up for checking by pressing **[SLEEP]**.

### To Cancel the Sleep Timer

Press **[SLEEP]** repeatedly until "SLEEP OFF" is displayed on the TV screen.

### Note:

- The sleep timer setting display will automatically disappear in 10 seconds.
- When you disconnect the unit from the AC outlet or when a power failure occurs, the sleep timer setting will be canceled.

## ✓ Channel Add/Delete

The channel add/delete function lets you add the channel that was not added by the auto channel scan due to the reception status at the initial setting. You can also delete the unnecessary channels.

**1** Press **[MENU]** to display the main menu.



**6** Press **[MENU]** to exit.



**2** Use **[CH ▲/▼]** to select "CHANNEL SETUP", then press **[VOL ▲]**.



e.g.) digital TV mode

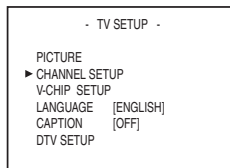

**Note:**

- "ADD/DELETE(DTV)" or "ADD/DELETE" menu will disappear automatically in about 10 seconds.
- In the digital mode (DTV), you can add or delete channels only for major channel.
- Once you delete a DTV channel, you cannot recover the channel without performing auto channel scan again. (Refer to "Auto Channel Scan" on page 11.)

**3** Use **[CH ▲/▼]** to select "ADD/DELETE(DTV)" or "ADD/DELETE", then press **[VOL ▲]**.



e.g.) digital TV mode

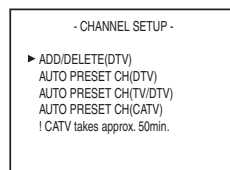

**4** Select the channel you want to add or delete. (Refer to "Channel Selection" on page 12.)

e.g.) digital TV mode



**5** Use **[VOL ▲/▼]** to select "ADD" or "DELETE".  
• To add or delete another channels, repeat steps 4 to 5.



- Color of channel number displayed at the right top of the TV screen indicates;
  - Blue: The selected channel will be added.
  - Red: The selected channel will be deleted.

## ✓ Picture Adjustment

You can adjust brightness, contrast, color, tint and sharpness.

1 Press [MENU] to display the main menu.



2 Use [CH ▲/▼] to select "PICTURE", then press [VOL ▲].

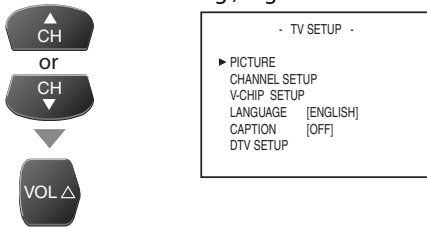

3 Use [CH ▲/▼] to select the picture quality type you want to adjust.

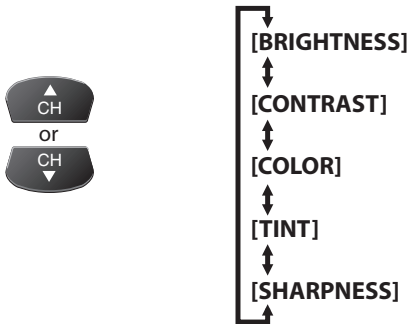

4 Use [VOL ▲/▼] to adjust the quality.



Selection	[VOL ▼]	[VOL ▲]
<b>BRIGHT</b>	to decrease brightness	to increase brightness
<b>CONTRAST</b>	to decrease contrast	to increase contrast
<b>COLOR</b>	to decrease color	to brighten color
<b>TINT</b>	to add purple	to add green
<b>SHARPNESS</b>	to make soft	to make clear

5 Press [MENU] to exit.



### Note:

- The picture adjustment setting display will automatically disappear in 10 seconds.

## ✓ Closed Caption

You can view closed captioning (cc) for TV programs, movies and news. Closed caption refer to text of dialogue or descriptions displayed on-screen for the hearing impaired.

1 Press [MENU] to display the main menu.



2 Use [CH ▲/▼] to select "CAPTION", then use [VOL ▲/▼] to change the setting.

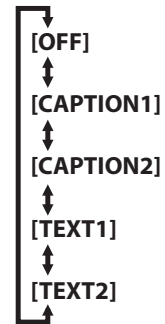
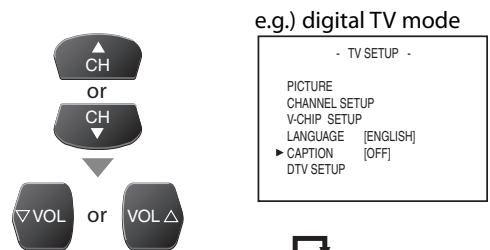

### [Caption Mode]

#### CAPTION1 (C1) and TEXT1 (T1);

are the primary caption and text services.

The captioning or text is displayed in the same language as the program's dialogue (up to 4 lines of script on the TV screen, where it does not obstruct relevant parts of the picture).

#### CAPTION2 (C2) and TEXT2 (T2);

are rarely available and broadcasters use them only in special conditions, such as when "CAPTION1" or "TEXT1" is not available.

• There are 3 display modes according to programs:

**Paint-on mode:** Displays input characters on the TV screen immediately.

**Pop-on mode:** Once characters are stored in memory, they are displayed all at once.

**Roll-up mode:** Displays the characters continuously by scrolling (max. 4 lines).



## ✓ DTV Closed Caption

DTV

In addition to the basic closed caption described on page 16, DTV has its own closed caption called DTVCC. Use this menu to change the settings for DTVCC.

3 Press [MENU] to exit.



### Note:

- To show the closed caption on your TV screen, broadcast signal must contain the closed caption data.
- Not all TV programs and commercials have the closed caption or all types of the closed caption.
- Captions and texts may not match the TV voice exactly.
- Changing channels may delay the closed caption for a few seconds.
- Adjusting or muting the volume may delay the closed caption for a few seconds.
- Abbreviations, symbols and other grammatical shortcuts may be used in order to keep pace with the on-screen action. This is not a problem with the unit.
- The caption or text characters will not be displayed while the main menu or functions display is shown.
- If a black box appears on the TV screen, this means that the closed caption is set to TEXT mode. To clear the box, select "C1", "C2" or "OFF".
- If the unit receives poor quality television signals, the captions may contain errors, or there might be no captions at all. Some possible causes of poor quality signals are:
  - Automobile ignition noise
  - Electric motor noise
  - Weak signal reception
  - Multiplex signal reception (ghosts or screen flutter)
- The unit retains the closed caption setting if the power fails.

1 Press [MENU] to display the main menu.



2 Use [CH ▲/▼] to select "DTV SETUP", then press [VOL ▲].



e.g.) digital TV mode

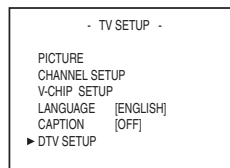

3 Use [CH ▲/▼] to select "DTVCC", then press [VOL ▲].



e.g.) digital TV mode

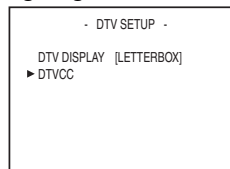

4 Use [CH ▲/▼] to select "CAPTION SERVICE", then use [VOL ▲/▼] to change the setting.

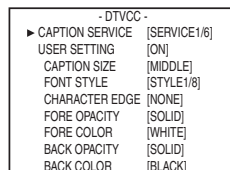
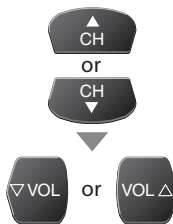

CAPTION SERVICE	OFF	Select if you do not want DTVCC. This is the default.
	SERVICE1~6	Select one of these before changing any other item in "CAPTION" menu. Choose "SERVICE1/6" under normal circumstances.

5 Press [MENU] to exit.



### Note:

- "CAPTION SERVICE" that you can switch differs depending on the broadcast description.

## ✔ DTVCC Style

DTV

You can change the style of DTV CC such as font, color or size, etc.

1 Press [MENU] to display the main menu.



2 Use [CH ▲/▼] to select "DTV SETUP", then press [VOL ▲].



e.g. digital TV mode

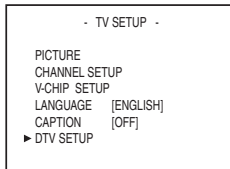

3 Use [CH ▲/▼] to select "DTVCC", then press [VOL ▲].



e.g. digital TV mode

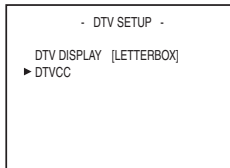

4 Use [CH ▲/▼] to select "USER SETTING", then use [VOL ▲/▼] to set to "ON".

• Items in the dotted box are available only when "USER SETTING" is "ON".

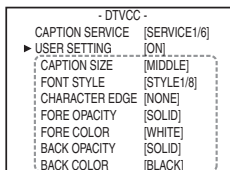
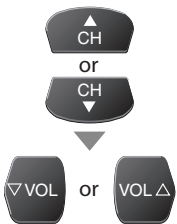

5 Use [CH ▲/▼] to select an item, then use [VOL ▲/▼] to change the setting for the item.

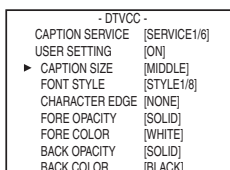
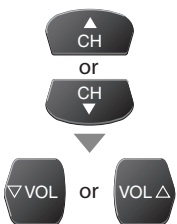

### • CAPTION SIZE

Closed captioning font size can be changed as below.

### • FONT STYLE

Font style of the displayed caption can be switched as below.

### • CHARACTER EDGE

Edge type of the displayed caption can be switched as below.

### • FORE COLOR, BACK COLOR

Font and background color of the displayed caption can be switched as below.

### • FORE OPACITY, BACK OPACITY

Text and background opacity of the displayed caption can be switched as below.

CAPTION SIZE	MIDDLE, LARGE, SMALL	
FONT STYLE	STYLE1/8	Proportional font used in the menu screen
	STYLE2/8	Monospaced with serifs
	STYLE3/8	Proportionally spaced with serifs
	STYLE4/8	Monospaced with serifs
	STYLE5/8	Proportionally spaced without serifs
	STYLE6/8	Casual font type
	STYLE7/8	Cursive font type
	STYLE8/8	Small capitals
CHARACTER EDGE	NONE, RAISED, DEPRESSED, UNIFORM, SHADOW LEFT, SHADOW RIGHT	
FORE OPACITY	SOLID, TRANSLUCENT, FLASH	
FORE COLOR	WHITE, BLACK, RED, GREEN, YELLOW, BLUE, MAGENTA, CYAN, TRANSPARENT	
BACK OPACITY	SOLID, TRANSLUCENT, FLASH	
BACK COLOR	BLACK, RED, GREEN, BLUE, YELLOW, MAGENTA, CYAN, TRANSPARENT, WHITE	

6 Press [MENU] to exit.



# ✓ V-chip

V-chip reads the ratings for programs, then denies access to the programs which exceed the rating level you set. With this function, you can block certain programming inappropriate for children.

1 Press [MENU] to display the main menu.



2 Use [CH ▲/▼] to select "V-CHIP SETUP", then press [VOL ▲].



e.g.) digital TV mode

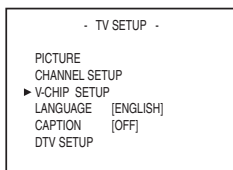

3 Use [the Number buttons] to enter the 4-digit numbers for your password.

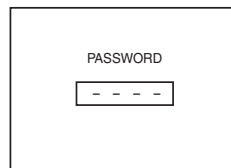
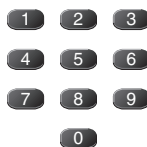

- When you have not set up your password, enter 0000.
- When the password is correct, the following "V-CHIP SETUP" menu is displayed.

See the following description for setting each item.

e.g.) digital TV mode

A... "A. TV Rating" ⇒ page 20

B... "B. MPAA Rating" ⇒ page 21

C... "C. Change Password" ⇒ page 21

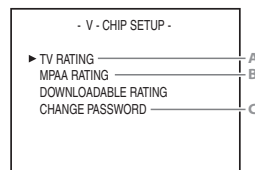

### Note:

- "DOWNLOADABLE RATING" will be available when the unit receives a digital broadcast using the new rating system.
- When you select a rating and set it to "BLOCK", the higher ratings will be blocked automatically. The lower ratings will be available for viewing.
- When you set the highest rating to "VIEW", all ratings turn to "VIEW" automatically.
- If the "PROTECTED PROGRAM" message appears during your TV viewing, change to a channel that is not blocked. Then, you can access "V-CHIP SETUP" menu and change the setting to allow all TV viewing.
- To block any inappropriate programming, set your limits in both "TV RATING" and "MPAA RATING".
- The V-chip setting will be retained after a power failure (except the access code reverts to 0000).

## A. TV Rating

- 4 Use [CH ▲/▼] to select "TV RATING", then press [VOL ▲].



e.g.) digital TV mode

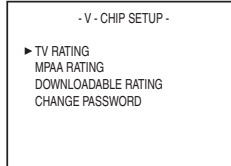

- 5 Use [CH ▲/▼] to select the desired rating, then press [VOL ▲] repeatedly to switch between "VIEW" and "BLOCK".

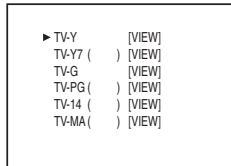

Rating	Category	
TV-Y	Appropriate for all children	lower ↑ ↓ higher
TV-Y7	Appropriate for all children 7 and older	
TV-G	General audience	
TV-PG	Parental guidance suggested	
TV-14	Unsuitable for children under 14	
TV-MA	Mature audience only	

### [To Set the Sub Ratings]

As for TV-Y7, TV-PG, TV-14 or TV-MA, you can further set the sub ratings to block specific elements of programming. To set the sub ratings, follow the steps below.

- 1 Use [CH ▲/▼] to select the desired main rating, then press [VOL ▲] twice to show its sub ratings.

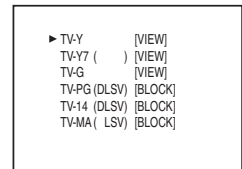

- 2 Use [CH ▲/▼], then press [VOL ▲] repeatedly to change the setting.



e.g.) TV-PG

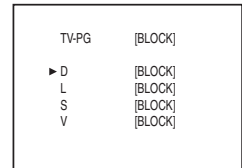

Sub Rating	Category	Rating
FV	Fantasy Violence	TV-Y7
V	Violence	TV-PG
S	Sexual Situation	TV-14
L	Coarse Language	TV-MA
D	Suggestive Dialogue	TV-PG, TV-14

- 6 Press [MENU] to exit.



### Note:

- Blocked sub ratings will appear beside the main rating category in "TV RATING" menu.
- You cannot block a sub rating (D, L, S or V) if the main rating is set to "VIEW".
- Changing the category to "BLOCK" or "VIEW" automatically changes all its sub ratings to the same ("BLOCK" or "VIEW").

## B. MPAA Rating

MPAA Rating is the rating system created by MPAA (Motion Picture Association of America).

- 4 Use [CH ▲/▼] to select "MPAA RATING", then press [VOL ▲].



e.g.) digital TV mode

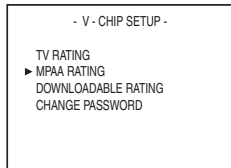

- 5 Use [CH ▲/▼], then press [VOL ▲] repeatedly to change the setting.

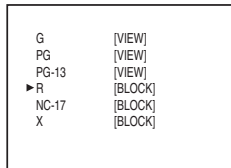

Rating	Category
<b>G</b>	General audience
<b>PG</b>	Parental guidance suggested
<b>PG-13</b>	Unsuitable for children under 13
<b>R</b>	Restricted; under 17 requires accompanying parent or adult guardian
<b>NC-17</b>	No one under 17 admitted
<b>X</b>	Mature audience only

- 6 Press [MENU] to exit.



## C. Change Password

Although the default code "0000" is supplied with the unit, you can set your own password.

- 4 Use [CH ▲/▼] to select "CHANGE PASSWORD", then press [VOL ▲].



e.g.) digital TV mode

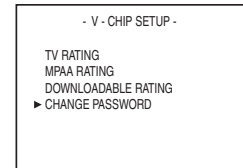

- 5 Press [the Number buttons] on the remote control to enter the new 4-digit password.

- Enter password again in "CONFIRM PASSWORD" space.

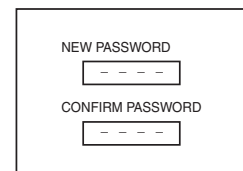
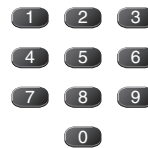

- 6 Press [MENU] to exit.



**Note:**

- Make sure new password and confirm password must be exactly the same. If they are different, the space is cleared for reentering.
- Your password will be erased and return to the default (0000) when a power failure occurs. If you forget the password, unplug the power cord for 10 seconds to restore the password to 0000.

## ✓ Troubleshooting Guide

If the unit does not perform properly when operated as instructed in this operation manual, check the following chart once before calling for service.

Symptom	Remedy
No power	<ul style="list-style-type: none"> <li>• Be sure the power cord is plugged in.</li> <li>• If a power failure occurs, unplug the power cord for 30 minutes to allow the unit to reset itself.</li> </ul>
No picture or sound	<ul style="list-style-type: none"> <li>• Check if the power is on.</li> <li>• Check the outlet connection.</li> <li>• Check the antenna or cable connection to the main unit.</li> <li>• When the outside antenna is used, check the wire condition and connection.</li> <li>• View other TV channels. The problem might be limited to the broadcasting station.</li> <li>• Turn off the power and wait for about 1 minute, then turn it on again.</li> </ul>
No color	<ul style="list-style-type: none"> <li>• Check the antenna or cable connection to the main unit.</li> <li>• When the outside antenna is used, check the wire condition and connection.</li> <li>• View other TV channels. The problem might be limited to the broadcasting station.</li> <li>• Adjust the "COLOR" in the setup screen.</li> </ul>
Sound OK, picture poor	<ul style="list-style-type: none"> <li>• Check the antenna or cable connection to the main unit.</li> <li>• When the outside antenna is used, check the wire condition and connection.</li> <li>• Electrical interference from nearby appliances may affect picture quality.</li> <li>• Adjust "CONTRAST" and "BRIGHT" in the setup screen.</li> <li>• View other TV channels. The problem might be limited to the broadcasting station.</li> </ul>
Picture distorted	<ul style="list-style-type: none"> <li>• When the outside antenna is used, check the wire condition and connection.</li> <li>• View other TV channels. The problem might be limited to the broadcasting station.</li> </ul>
Weak picture	<ul style="list-style-type: none"> <li>• Check the antenna or cable connection to the main unit.</li> <li>• When the outside antenna is used, check the wire condition and connection.</li> <li>• Adjust "CONTRAST" and "BRIGHT" in the setup screen.</li> <li>• View other TV channels. The problem might be limited to the broadcasting station.</li> </ul>
Lines or streaks in picture	<ul style="list-style-type: none"> <li>• When the outside antenna is used, check the wire condition and connection.</li> <li>• Electrical interference from nearby appliances may affect picture quality.</li> <li>• View other TV channels. The problem might be limited to the broadcasting station.</li> </ul>
Picture blurred	<ul style="list-style-type: none"> <li>• When the outside antenna is used, check the wire condition and connection.</li> <li>• View other TV channels. The problem might be limited to the broadcasting station.</li> </ul>
Ghosts in picture	<ul style="list-style-type: none"> <li>• Check the antenna or cable connection to the main unit.</li> <li>• When the outside antenna is used, check the wire condition and connection.</li> <li>• Electrical interference from nearby appliances may affect picture quality.</li> <li>• View other TV channels. The problem might be limited to the broadcasting station.</li> </ul>
Bars on screen	<ul style="list-style-type: none"> <li>• When the outside antenna is used, check the wire condition and connection.</li> <li>• Electrical interference from nearby appliances may affect picture quality.</li> </ul>
Picture rolls vertically	<ul style="list-style-type: none"> <li>• When the outside antenna is used, check the wire condition and connection.</li> <li>• Electrical interference from nearby appliances may affect picture quality.</li> <li>• View other TV channels. The problem might be limited to the broadcasting station.</li> </ul>
Different color marks on screen	<ul style="list-style-type: none"> <li>• Move the unit away from nearby electric appliances. Turn off the power and wait 30 minutes before turning it back on.</li> <li>• View other TV channels. The problem might be limited to the broadcasting station.</li> </ul>
Poor reception on some channels	<ul style="list-style-type: none"> <li>• Check the antenna or cable connection to the main unit.</li> <li>• When the outside antenna is used, check the wire condition and connection.</li> <li>• Electrical interference from nearby appliances may affect picture quality.</li> <li>• View other TV channels. The problem might be limited to the broadcasting station.</li> </ul>
Picture OK, sound poor	<ul style="list-style-type: none"> <li>• View other TV channels. The problem might be limited to the broadcasting station.</li> </ul>
No reception of digital signals	<ul style="list-style-type: none"> <li>• Make sure auto channel scan has been completed (Refer to "Auto Channel Scan" on page 11). Auto channel scan must be completed when you set up the unit for the first time or move it to a location where previously unavailable channels are broadcast.</li> <li>• The selected channel may not be broadcasting.</li> <li>• When auto channel scan is interrupted and not completed, some channels will not be received. Make sure to complete (Refer to "Auto Channel Scan" on page 11).</li> </ul>

Symptom	Remedy
The entered channel number changes automatically	<ul style="list-style-type: none"> <li>Many digital channels have alternate channel numbers. The unit changes the numbers automatically to the ones signifying the broadcasting stations. These are the numbers used for analog broadcasts.</li> </ul>
Remote control does not work	<ul style="list-style-type: none"> <li>Check the antenna or cable connection to the main unit.</li> <li>Check the batteries of the remote control.</li> <li>Check if there is an obstacle between the infrared sensor window and the remote control.</li> <li>Test the signal output. If OK, then possible infrared sensor trouble. (Refer to "IR Signal Check" on page 23.)</li> <li>Aim the remote control directly at the infrared sensor window on the front of the unit.</li> <li>Reduce the distance to the unit.</li> <li>Re-insert the batteries with their polarities (+/- signs) as indicated.</li> </ul>

### Problems with Closed Caption Feature

Misspelled captions are displayed.	<ul style="list-style-type: none"> <li>Closed captioning production companies may broadcast programs without correcting the misspelling in a live broadcast.</li> </ul>
Captions are not entirely displayed, or captions are delayed behind the dialogue.	<ul style="list-style-type: none"> <li>Captions that are delayed a few seconds behind the actual dialogue are common for live broadcasts. Most captioning production companies can display a dialogue to a maximum of 220 words per minute. If a dialogue exceeds that rate, selective editing is used to insure that the captions remain up-to-date with the current TV screen dialogue.</li> </ul>
Captions are displayed as a white box. No caption is displayed in the closed caption-supported program.	<ul style="list-style-type: none"> <li>Interference from buildings or weather conditions may cause captioning to be incomplete.</li> <li>Broadcasting station may shorten the program to insert advertisement. The closed caption decoder cannot read the information of the shortened program.</li> </ul>
No caption is displayed when playing the videotape containing captions.	<ul style="list-style-type: none"> <li>The videotape may be illegally copied, or the caption signal might not have been read during copying.</li> </ul>
Black box is displayed in the TV screen.	<ul style="list-style-type: none"> <li>Text mode is selected for caption. Select "C1", "C2" or "OFF".</li> </ul>

#### Note:

Some functions are not available in specific modes, but this is not a malfunction. Read the description in this operation manual for more details on correct operations.

## ✓ Maintenance

### Cabinet Cleaning

- Wipe the front panel and other exterior surfaces of the unit with a soft cloth immersed in lukewarm water and wrung dry.
- Never use a solvent or alcohol. Do not spray insecticide liquid near the unit. Such chemicals may cause damage and discoloration to the exposed surfaces.

### Panel Cleaning

Wipe the panel of the unit with a soft cloth. Before cleaning the panel, disconnect the power cord.

### Servicing

Should your unit become inoperative, do not try to correct the problem yourself. There are no user serviceable parts inside. Turn off the unit, unplug the power cord and call our toll free customer support line found on the cover of this manual to locate an authorized service center.

### Degaussing

A degaussing circuit in this unit clears up color errors on the TV screen. Color errors occur when there is any excess magnetism close to the unit. This circuit is designed to operate once when the unit is first plugged in. If you see minor color errors on the screen, unplug the unit for approximately 30 minutes. When you plug the unit again, the degaussing circuit will operate to clear errors. Take this step any time the TV screen is accidentally magnetized or when you move the unit.

### IR Signal Check

If the remote control is not working properly, you can use an AM radio or digital camera (including a cellular phone with built-in camera) to see if it is sending out an infrared signal.

#### • With an AM radio:

Tune the AM radio station to a non-broadcasting frequency. Point the remote control towards it, push any button and listen. If the sound from the radio flutters, it is receiving the remote control's infrared signal.

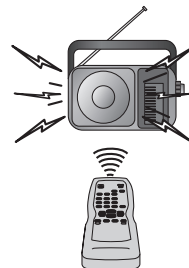

#### • With a digital camera (including built-in cell phone cameras)

Point a digital camera towards the remote control. Push any button on the remote control and look through the digital camera. If the infrared light appears through the camera, the remote control is working.



**✓ Glossary**

**ATSC**

Acronym that stands for Advanced Television Systems Committee and the name of the digital broadcasting standards.

**Aspect Ratio**

The width of a TV screen relative to its height. Conventional TVs are 4:3 (in other words, the TV screen is almost square); widescreen models are 16:9 (the TV screen is almost twice as wide as its height).

**Dolby Digital**

The system developed by Dolby Laboratories to compress digital sound. It offers stereo sound (2ch) or multi-channel audio.

**HDTV (high definition TV)**

Ultimate digital format that produces high resolution and high picture quality.

**NTSC**

Acronym that stands for National Television Systems Committee and the name of the current analog broadcasting standards.

**Password**

A stored 4-digit number that allows access to parental control features.

**SDTV (standard definition TV)**

Standard digital format that is similar to the NTSC picture quality.

**✓ Cable Channel Designations**

If you subscribe to cable TV, the channels are displayed as 1-135. Cable companies often designate channels with letters or letter-number combinations. Please check with your local cable company. The following is a chart of common cable channel designations.

CATV channel	5A	2	3	4	5	6	7	8	9	10	11	12	13	A	B	C	D	E	F	G	H
TV Display	1	2	3	4	5	6	7	8	9	10	11	12	13	14	15	16	17	18	19	20	21
CATV channel	I	J	K	L	M	N	O	P	Q	R	S	T	U	V	W	W+1	W+2	W+3	W+4	W+5	W+6
TV Display	22	23	24	25	26	27	28	29	30	31	32	33	34	35	36	37	38	39	40	41	42
CATV channel	W+7	W+8	W+9	W+10	W+11	W+12	W+13	W+14	W+15	W+16	W+17	W+18	W+19	W+20	W+21	W+22	W+23	W+24	W+25	W+26	W+27
TV Display	43	44	45	46	47	48	49	50	51	52	53	54	55	56	57	58	59	60	61	62	63
CATV channel	W+28	W+29	W+30	W+31	W+32	W+33	W+34	W+35	W+36	W+37	W+38	W+39	W+40	W+41	W+42	W+43	W+44	W+45	W+46	W+47	W+48
TV Display	64	65	66	67	68	69	70	71	72	73	74	75	76	77	78	79	80	81	82	83	84
CATV channel	W+49	W+50	W+51	W+52	W+53	W+54	W+55	W+56	W+57	W+58	A-5	A-4	A-3	A-2	A-1	W+59	W+60	W+61	W+62	W+63	W+64
TV Display	85	86	87	88	89	90	91	92	93	94	95	96	97	98	99	100	101	102	103	104	105
CATV channel	W+65	W+66	W+67	W+68	W+69	W+70	W+71	W+72	W+73	W+74	W+75	W+76	W+77	W+78	W+79	W+80	W+81	W+82	W+83	W+84	W+85
TV Display	106	107	108	109	110	111	112	113	114	115	116	117	118	119	120	121	122	123	124	125	126
CATV channel	W+86	W+87	W+88	W+89	W+90	W+91	W+92	W+93	W+94												
TV Display	127	128	129	130	131	132	133	134	135												

**✓ General Specifications**

**TV format:** ATSC / NTSC-M TV standard

**Closed caption system:** \$15.122/FCC (digital CC) \$15.119/FCC (analog CC)

**Channel coverage (ATSC/NTSC):**  
**Terrestrial VHF:** 2~13 **UHF:** 14~69  
**CATV** 2~13, A~W, W+1~W+94 (analog W+1~W+84), A-5~A-1, 5A

**Tuning system:** Channel frequency synthesized tuning system

**Channel access:** Direct access keyboard, Programmable scan, and up/down

**✓ Electrical Specification**

**Sound output:** 1W, 8Ω x 1

- Designs and specifications are subject to change without notice and without our legal obligation.
- If there is a discrepancy between languages, the default language will be English.

**✓ Other Specifications**

**Terminals:**

**Antenna input:** VHF/UHF/CATV 75Ω unbalanced (F-type)

**Video input:** RCA jack x 1 1Vp-p (75Ω)

**Audio input:** RCA jack x 1 2V rms (input impedance: more than 22kΩ)

**Coaxial digital audio output:** RCA jack x1 500mVp-p (75Ω)

**Earphone:** 1/8 inches (3.5mm)

**Remote control:**

Digital encoded infrared light system

**Operating temperature:**

41°F (5°C) to 104°F (40°C)

**Power requirements:**

120V AC +/- 10%, 60Hz +/- 0.5%

**Power consumption (maximum):**

60W

**Picture tube:** 13 inches

**Dimensions:** **W:** 15.8 inches (400mm)

**H:** 13.4 inches (340mm)

**D:** 14.6 inches (370mm)

**Weight:** 19.6 lbs. (8.9kg)





# **SYLVANIA**

## **LIMITED WARRANTY**

FUNAI CORP. will repair this product, free of charge in the USA in the event of defect in materials or workmanship as follows:

### **DURATION:**

**PARTS:** FUNAI CORP. will provide parts to replace defective parts without charge for one (1) year from the date of original retail purchase. Two (2) years for Picture Tube. Certain parts are excluded from this warranty.

**LABOR:** FUNAI CORP. will provide the labor without charge for a period of ninety (90) days from the date of original retail purchase.

### **LIMITS AND EXCLUSIONS:**

THIS WARRANTY IS EXTENDED ONLY TO THE ORIGINAL RETAIL PURCHASER. A PURCHASE RECEIPT OR OTHER PROOF OF ORIGINAL RETAIL PURCHASE WILL BE REQUIRED TOGETHER WITH THE PRODUCT TO OBTAIN SERVICE UNDER THIS WARRANTY.

This warranty shall not be extended to any other person or transferee.

This warranty is void and of no effect if any serial numbers on the product are altered, replaced, defaced, missing or if service was attempted by an unauthorized service center. This limited warranty does not apply to any product not purchased and used in the United States.

This warranty only covers failures due to defects in material or workmanship which occur during normal use. It does not cover damage which occurs in shipment, or failures which are caused by repairs, alterations or products not supplied by FUNAI CORP., or damage, which results from accident, misuse, abuse, mishandling, misapplication, alteration, faulty installation, improper maintenance, commercial use such as hotel, rental or office use of this product, or damage which results from fire, flood, lightning or other acts of God.

THIS WARRANTY DOES NOT COVER PACKING MATERIALS, ANY ACCESSORIES (EXCEPT REMOTE CONTROL), ANY COSMETIC PARTS, COMPLETE ASSEMBLY PARTS, DEMO OR FLOOR MODELS.

FUNAI CORP. AND ITS REPRESENTATIVES OR AGENTS SHALL IN NO EVENT BE LIABLE FOR ANY GENERAL, INDIRECT OR CONSEQUENTIAL DAMAGES ARISING OUT OF OR OCCASIONED BY THE USE OF OR THE INABILITY TO USE THIS PRODUCT. THIS WARRANTY IS MADE IN LIEU OF ALL OTHER WARRANTIES, EXPRESS OR IMPLIED, AND OF ALL OTHER LIABILITIES ON THE PART OF FUNAI, ALL OTHER WARRANTIES INCLUDING THE WARRANTY OF MERCHANTABILITY AND FITNESS FOR A PARTICULAR PURPOSE, ARE HEREBY DISCLAIMED BY FUNAI AND ITS REPRESENTATIVES IN THE UNITED STATES.

ALL WARRANTY INSPECTIONS AND REPAIRS MUST BE PERFORMED BY AN AUTHORIZED SERVICE CENTER. THIS WARRANTY IS ONLY VALID WHEN THE UNIT IS CARRIED-IN TO AN AUTHORIZED SERVICE CENTER.

THE PRODUCT MUST BE ACCOMPANIED BY A COPY OF THE ORIGINAL RETAIL PURCHASE RECEIPT. IF NO PROOF OF PURCHASE IS ATTACHED, THE WARRANTY WILL NOT BE HONORED AND REPAIR COSTS WILL BE CHARGED.

### **IMPORTANT:**

THIS LIMITED WARRANTY GIVES YOU SPECIFIC LEGAL RIGHTS. YOU MAY HAVE OTHER RIGHTS THAT VARY FROM STATE TO STATE. IF, AT ANY TIME DURING THE WARRANTY PERIOD, YOU ARE UNABLE TO OBTAIN SATISFACTION WITH THE REPAIR OF THIS PRODUCT, PLEASE CONTACT FUNAI CORP.

### **ATTENTION:**

FUNAI CORP. RESERVES THE RIGHT TO MODIFY ANY DESIGN OF THIS PRODUCT WITHOUT PRIOR NOTICE.

### **WARRANTY STATEMENT REGARDING NON AUTHORIZED REPAIRS:**

To obtain warranty service, you must take the product, or deliver the product freight prepaid, in either its original packaging or packaging affording an equal degree of protection, to any AUTHORIZED SERVICE CENTER. FUNAI CORP. will not reimburse you for any service done by unauthorized service providers without prior written approval.

To locate your nearest AUTHORIZED SERVICE CENTER or for general service inquiries, please contact us at:

FUNAI CORPORATION

Customer Service

**Tel : 1-800-968-3429**

**<http://www.SylvaniaConsumerElectronics.com>**

19900 Van Ness Avenue, Torrance, CA 90501

## Free Manuals Download Website

<http://myh66.com>

<http://usermanuals.us>

<http://www.somanuals.com>

<http://www.4manuals.cc>

<http://www.manual-lib.com>

<http://www.404manual.com>

<http://www.luxmanual.com>

<http://aubethermostatmanual.com>

Golf course search by state

<http://golfingnear.com>

Email search by domain

<http://emailbydomain.com>

Auto manuals search

<http://auto.somanuals.com>

TV manuals search

<http://tv.somanuals.com>