

# OWNER'S MANUAL

# SYLVANIA

## DVD PLAYER DVL100CC

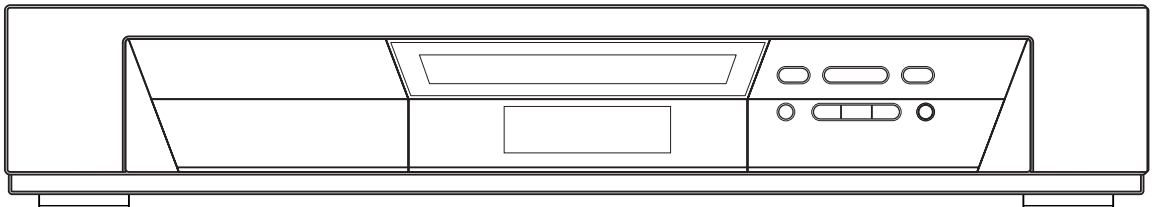

If you need additional assistance for set-up or operating  
after reading owner's manual, please call  
**TOLL FREE : 1-800-287-4871**

## WARNING:

TO REDUCE THE RISK OF FIRE OR ELECTRIC SHOCK, DO NOT EXPOSE THIS APPLIANCE TO RAIN OR MOISTURE.



### CAUTION

RISK OF ELECTRIC SHOCK  
DO NOT OPEN



#### CAUTION:

TO REDUCE THE RISK OF ELECTRIC SHOCK, DO NOT REMOVE COVER (OR BACK). NO USER SERVICEABLE PARTS INSIDE. REFER SERVICING TO QUALIFIED SERVICE PERSONNEL.



The lightning flash with arrowhead symbol, within an equilateral triangle, is intended to alert the user to the presence of uninsulated “dangerous voltage” within the product’s enclosure that may be of sufficient magnitude to constitute a risk of electric shock to persons.



The exclamation point within an equilateral triangle is intended to alert the user to the presence of important operating and maintenance (servicing) instructions in the literature accompanying the appliance.

## LASER SAFETY

This unit employs a laser. Only a qualified service person should remove the cover or attempt to service this device, due to possible eye injury.

**CAUTION:** USE OF CONTROLS OR ADJUSTMENTS OR PERFORMANCE OF PROCEDURES OTHER THAN THOSE SPECIFIED HEREIN MAY RESULT IN HAZARDOUS RADIATION EXPOSURE.

**CAUTION:** VISIBLE AND INVISIBLE LASER RADIATION WHEN OPEN AND INTERLOCK DEFEATED. DO NOT STARE INTO BEAM.

**LOCATION:** INSIDE, NEAR THE DECK MECHANISM.

**FCC WARNING-** This equipment may generate or use radio frequency energy. Changes or modifications to this equipment may cause harmful interference unless the modifications are expressly approved in the instruction manual. The user could lose the authority to operate this equipment if an unauthorized change or modification is made.

### RADIO-TV INTERFERENCE

This equipment has been tested and found to comply with the limits for a Class B digital device, pursuant to Part 15 of the FCC Rules. These limits are designed to provide reasonable protection against harmful interference in a residential installation. This equipment generates, uses, and can radiate radio frequency energy and, if not installed and used in accordance with the instructions, may cause harmful interference to radio communications. However, there is no guarantee that interference will not occur in a particular installation. If this equipment does cause harmful interference to radio or television reception, which can be determined by turning the equipment off and on, the user is encouraged to try to correct the interference by one or more of the following measures:

- 1) Reorient or relocate the receiving antenna.
- 2) Increase the separation between the equipment and receiver.
- 3) Connect the equipment into an outlet on a circuit different from that to which the receiver is connected.
- 4) Consult the dealer or an experienced radio/TV technician for help.

**This Class B digital apparatus complies with Canadian ICES-003.**

**CAUTION: TO PREVENT ELECTRIC SHOCK, MATCH WIDE BLADE OF PLUG TO WIDE SLOT, FULLY INSERT.**

# IMPORTANT SAFEGUARDS

- 1) Read Instructions - All the safety and operating instructions should be read before the product is operated.
- 2) Retain Instructions - The safety and operating instructions should be retained for future reference.
- 3) Heed Warnings - All warnings on the product and in the operating instructions should be adhered to.
- 4) Follow Instructions - All operating and use instructions should be followed.
- 5) Cleaning - Unplug this product from the wall outlet before cleaning. Do not use liquid cleaners or aerosol cleaners. Use a damp cloth for cleaning.
- 6) Attachments - Do not use attachments not recommended by the product manufacturer as they may cause hazards.
- 7) Water and Moisture - Do not use this product near water - for example, near a bath tub, wash bowl, kitchen sink, or laundry tub; in a wet basement; or near a swimming pool; and the like.
- 8) Accessories - Do not place this product on an unstable cart, stand, tripod, bracket, or table. The product may fall, causing serious injury to a child or adult, and serious damage to the product. Use only with a cart, stand, tripod, bracket, or table recommended by the manufacturer, or sold with the product. Any mounting of the product should follow the manufacturer's instructions, and should use a mounting accessory recommended by the manufacturer.
- 9) A product and cart combination should be moved with care. Quick stops, excessive force, and uneven surfaces may cause the product and cart combination to overturn.
- 10) Ventilation - Slots and openings in the cabinet are provided for ventilation and to ensure reliable operation of the product and to protect it from overheating, and these openings must not be blocked or covered. The openings should never be blocked by placing the product on a bed, sofa, rug, or other similar surface. This product should not be placed in a built-in installation such as a bookcase or rack unless proper ventilation is provided or the manufacturer's instructions have been adhered to.
- 11) Power Sources - This product should be operated only from the type of power source indicated on the marking label. If you are not sure of the type of power supply to your home, consult your product dealer or local power company. For products intended to operate from battery power, or other sources, refer to the operating instructions.
- 12) Grounding or Polarization - This product may be equipped with a polarized alternating-current line plug (a plug having one blade wider than the other). This plug will fit into the power outlet only one way. This is a safety feature. If you are unable to insert the plug fully into the outlet, try reversing the plug. If the plug should still fail to fit, contact your electrician to replace your obsolete outlet. Do not defeat the safety purpose of the polarized plug.
- 13) Power-Cord Protection - Power-supply cords should be routed so that they are not likely to be walked on or pinched by items placed upon or against them, paying particular attention to cords at plugs, convenience receptacles, and the point where they exit from the product.
- 14) Lightning - For added protection for this product during a lightning storm, or when it is left unattended and unused for long periods of time, unplug it from the wall outlet and disconnect the antenna or cable system. This will prevent damage to the product due to lightning and power-line surges.
- 15) Power lines - An outside antenna system should not be located in the vicinity of overhead power lines or other electric light or power circuits, or where it can fall into such power lines or circuits. When installing an outside antenna system, extreme care should be taken to keep from touching such power lines or circuits as contact with them might be fatal.
- 16) Overloading - Do not overload wall outlets, extension cords, or integral convenience receptacles as this can result in a risk of fire or electric shock.
- 17) Object and Liquid Entry - Never push objects of any kind into this product through openings as they may touch dangerous voltage points or short-out parts that could result in a fire or electric shock. Never spill liquid of any kind on the product.
- 18) Servicing - Do not attempt to service this product yourself as opening or removing covers may expose you to dangerous voltage or other hazards. Refer all servicing to qualified service personnel.
- 19) Damage Requiring Service - Unplug this product from the wall outlet and refer servicing to qualified service personnel under the following conditions:
  - a) When the power-supply cord or plug is damaged,
  - b) If liquid has been spilled, or objects have fallen into the product,
  - c) If the product has been exposed to rain or water,
  - d) If the product does not operate normally by following the operating instructions. Adjust only those controls that are covered by the operating instructions as an improper adjustment of other controls may result in damage and will often require extensive work by a qualified technician to restore the product to its normal operation,
  - e) If the product has been dropped or damaged in any way, and
  - f) When the product exhibits a distinct change in performance - this indicates a need for service.
- 20) Replacement Parts - When replacement parts are required, be sure the service technician has used replacement parts specified by the manufacturer or have the same characteristics as the original part. Unauthorized substitutions may result in fire, electric shock, or other hazards.
- 21) Safety Check - Upon completion of any service or repairs to this product, ask the service technician to perform safety checks to determine that the product is in proper operating condition.
- 22) Heat - The product should be situated away from heat sources such as radiators, heat registers, stoves, or other products (including amplifiers) that produce heat.

PORTABLE CART WARNING  
(Symbol provided by RETAC)



S3125A

## A NOTE ABOUT RECYCLING

This product's packaging materials are recyclable and can be reused. Please dispose of any materials in accordance with your local recycling regulations.

Batteries should never be thrown away or incinerated but disposed of in accordance with your local regulations concerning chemical wastes.

The serial number of this product may be found on the back of the DVD player. No others have the same serial number as yours. You should record the number and other vital information here and retain this book as a permanent record of your purchase to aid identification in case of theft. Serial numbers are not kept on file.



Date of Purchase	
Dealer Purchase from	
Dealer Address	
Dealer Phone No.	
Model No.	
Serial No.	

## ABOUT COPYRIGHT

Unauthorized copying, broadcasting, public performance and lending of discs are prohibited.

This product incorporates copyright protection technology that is protected by method claims of certain U.S. patents and other intellectual property rights owned by Macrovision Corporation and other rights owners. Use of this copyright protection technology must be authorized by Macrovision Corporation, and is intended for home and other limited viewing uses only unless otherwise authorized by Macrovision Corporation. Reverse engineering or disassembly is prohibited.

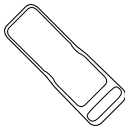
## SUPPLIED ACCESSORIES

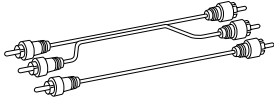
<p>Remote control</p>  <p>(N9068UD)</p>	<p>Two AA batteries</p> 	<p>A/V cables</p>  <p>(approx. 3 feet (100 cm) long) (WPZ0102TM015)</p>
--	---	---

## SYMBOLS USED IN THIS MANUAL

The following symbols appear below in some headings and notes in this manual, with the following meanings!

**DVD**

: Description refers to playback of DVD video discs.

**CD**

: Description refers to playback of audio CDs.

**MP3**

: Description refers to playback of MP3 discs.

# TABLE OF CONTENTS

■ <b>LASER SAFETY</b> .....	2
■ <b>IMPORTANT SAFEGUARDS</b> .....	3
ABOUT COPYRIGHT .....	4
SUPPLIED ACCESSORIES .....	4
SYMBOLS USED IN THIS MANUAL .....	4
■ <b>FEATURES</b> .....	6
■ <b>ABOUT THE DISCS</b> .....	7
PLAYABLE DISCS .....	7
DISC TYPES .....	7
■ <b>OPERATING CONTROLS AND FUNCTIONS</b> .....	8
DISPLAY .....	9
DISPLAYS DURING OPERATION .....	9
LOADING THE BATTERIES .....	9
■ <b>HOOKUPS</b> .....	10
CONNECTING TO A TV .....	10
CONNECTING TO A DOLBY DIGITAL DECODER OR DTS DECODER .....	11
CONNECTING TO A TV OR A STEREO TV THAT HAS COMPONENT VIDEO IN JACKS .....	11
CONNECTING TO AN AMPLIFIER EQUIPPED WITH DIGITAL INPUT JACKS SUCH AS MD DECK OR DAT DECK .....	12
■ <b>PLAYING A DISC</b> .....	13
PLAYING A DVD VIDEO OR AN AUDIO CD .....	13
USING THE DVD MENUS .....	13
USING THE TITLE MENU .....	14
PAUSING PLAYBACK OR DISPLAYING A STILL PICTURE .....	14
RESUMING PLAYBACK FROM THE POINT WHERE PLAYBACK STOPPED .....	14
STEPPING THROUGH FRAMES .....	14
FAST FORWARD/REVERSE .....	15
SLOW MOTION .....	15
STARTING FROM A DESIRED TRACK .....	15
PLAYING FROM A DESIRED TITLE OR CHAPTER .....	15
STARTING FROM A DESIRED TIME COUNT .....	16
MARKER .....	16
RANDOM (Audio CD) .....	16
REPEAT .....	17
A-B REPEAT .....	17
PROGRAM (Audio CD) .....	18
ZOOM PLAYBACK .....	18
PLAYING AN MP3 DISC .....	19
CHANGING THE ONSCREEN DISPLAY DURING MP3 DISC PLAY .....	19
PLAYING AN MP3 DISC FROM A DESIRED TRACK .....	20
PLAYING AN MP3 DISC AT RANDOM .....	20
PLAYING AN MP3 DISC IN A PROGRAMMED WAY .....	20
■ <b>SETTINGS</b> .....	21
CHANGING THE AUDIO LANGUAGE OR SOUND MODE .....	21
CHANGING THE SUBTITLE LANGUAGE .....	22
CHANGING THE CAMERA ANGLE (Multi-Angle Pictures) .....	22
CHANGING THE ON-SCREEN DISPLAY .....	23
BLACK LEVEL SETTINGS .....	23
TRUSURROUND SETTINGS .....	23
■ <b>CHANGING THE SETUP ITEMS</b> .....	24
LANGUAGE SETTINGS .....	24
DISPLAY SETTINGS .....	25
AUDIO SETTINGS .....	26
PARENTAL LOCK .....	27
■ <b>LANGUAGE CODE LIST</b> .....	28
■ <b>TROUBLESHOOTING GUIDE</b> .....	29
■ <b>HANDLING PRECAUTIONS</b> .....	30
DISC HANDLING .....	30
■ <b>SPECIFICATIONS</b> .....	31
■ <b>WARRANTY</b> .....	32

# FEATURES

## ● **Dolby Digital sound**

This player can handle Dolby Digital surround sound having 5.1 channels when connected to a Dolby Digital decoder.

## ● **Still/fast/slow/step playback**

Various playback modes are available including still pictures, fast forward/reverse, slow motion and step frames.

## ● **Random playback for audio CD and MP3**

This player can shuffle the order of tracks to play them in random order.

## ● **Program playback for audio CD and MP3**

You can program the order of tracks to play them in any desired order.

## ● **DVD menus in a desired language**

You can display DVD menus in a desired language, if available on a DVD.

## ● **Screen saver/Auto power-off functions**

The screen saver program starts when there is no input from the player for five minutes in the stop mode. When the screen saver program is activated for 35 minutes, the power is automatically turned off.

## ● **Subtitles in a desired language**

You can select a desired language for the display subtitles, if that language is available on a disc.

## ● **Selecting a camera angle**

You can select the desired camera angle, if a disc contains sequences recorded from different angles.

## ● **Choices for audio language and sound mode**

You can select the desired audio language and sound mode, if different languages and modes are available on a disc.

## ● **Parental lock**

You can set the control level to limit playback of discs which may not be suitable for children.

## ● **Automatic detection of discs**

This player automatically detects if a loaded disc is DVD, audio CD or MP3 on disc.

## ● **Playing an MP3 disc**

You can enjoy MP3 files which are recorded on CD-R/RW.

## ● **Direct Search**

You can search the desired title, chapter, and track with numeric button during playback or in stop mode.

## ● **On-screen display**

Information about the current operation can be displayed on a TV screen, allowing you to confirm the currently active functions (such as program playback), on the TV screen using the remote control.

## ● **DTS (Digital Theater System)**

You can enjoy 5.1 channel surround system developed by the Digital Theater System co. which reproduces the original sound as truthfully as possible.

## ● **Search**

Chapter search: Search for the chapter designated by user is possible.

Title search: Search for the title designated by user is possible.

Track search: Search for the track designated by user is possible.

Time search: Search for the time designated by user is possible.

## ● **Repeat**

Chapter: Repeated playback of the chapter of the disc being played is possible.

Title: Repeated playback of the title of the disc being played is possible.

Track: Repeated playback of the track of the disc being played is possible.

Disc (audio CD): Repeated playback of the entire disc being played is possible.

(MP3)  
A-B: The part between A and B designated by user is possible.

Album: Repeated playback of the folder of the MP3 disc being played is possible.

## ● **Zoom**

2-time and 4-time magnified screen can be displayed.

## ● **Marker**

The part designated by user can be called back.

## ● **Resume Play**

User can resume to playback from the part at which the play was stopped even if the power turn off.

## ● **SRS TruSurround**

You can enjoy stereophonic virtual space on your existing stereo system.

## ● **Component Video Out Jacks**

Jacks located on the back of the DVD Player which are used to send high-quality video to a TV via Component Video In Jacks.

## ● **Dimmer**

Brightness of the display can be varied.

## ● **Bit rate indication**

## ● **DRC (Dynamic range control)**

You can control the range of sound volume.

This unit employs TruSurround system

**TruSurround**<sup>™</sup> by **SRS** (●) of SRS Labs, Inc. as virtual technology.



TruSurround and the (●) symbol are trademarks of SRS Labs, Inc.

TruSurround technology is incorporated under license from SRS Labs, Inc.

# ABOUT THE DISCS

## PLAYABLE DISCS

The following discs can be played back on this DVD player.

Disc Type	Logo	Contents	Disc Size	Maximum Playback Time
DVD Video		Sound and Pictures	12 cm	Approx. 4 h (single-sided)
				Approx. 8 h (double-sided)
	8 cm		Approx. 80 min (single-sided)	
			Approx. 160 min (double-sided)	
Audio CD		Sound	12 cm	74 min
			8 cm (singles)	20 min

This player conforms to the NTSC color system. You cannot play discs recorded in other color systems such as PAL or SECAM.

- Some discs include region codes as shown below.



- The number inside the symbol refers to a region of the world, and a disc encoded in a specific region format can only be played back on DVD players with the same region code.

The following discs cannot be played back on this DVD player.

- DVD with region codes other than 1 or ALL.
- DVD-ROM
- DVD-RAM (Never play back, otherwise malfunction may result.)
- CD-ROM
- VSD
- CDV (Only plays back the audio part.)
- CD-G (Only plays back the sound.)
- CD-R/CD-RW (Only plays back the discs which audio CD and MP3 is recorded.)
- CD-I (Never play back, otherwise malfunction may result.)
- SACD
- Photo CD (Never play back, otherwise malfunction may result.)
- Video CD (Never play back, otherwise malfunction may result.)

Any other discs without compatibility indications

## DISC TYPES

### [DVD]

Data on a DVD is divided into sections called "titles", and then into subsections called "chapters", each of which is given a title or chapter number. Playback conditions are preset on some DVD video discs, and these playback conditions take priority over user operations on this player. If a function you selected do not run as desired, refer to the manual accompanying the disc.

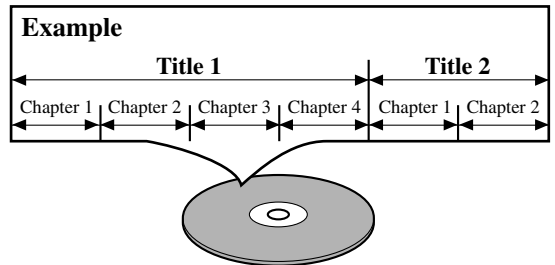

### [AUDIO CD]

Data on an audio CD is divided into sections called "tracks", each of which is given a track number.

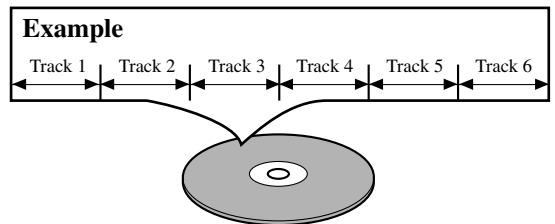

### [MP3]

Data on a MP3 is divided into sections called "albums", and then into subsections called "tracks", each of which is given an album or track number.

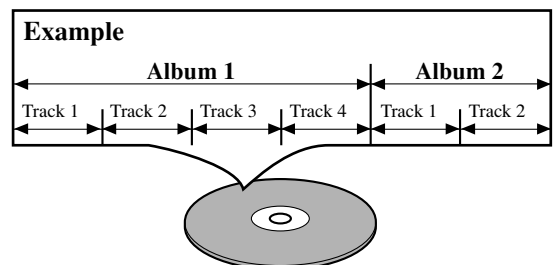

# OPERATING CONTROLS AND FUNCTIONS

## FRONT PANEL

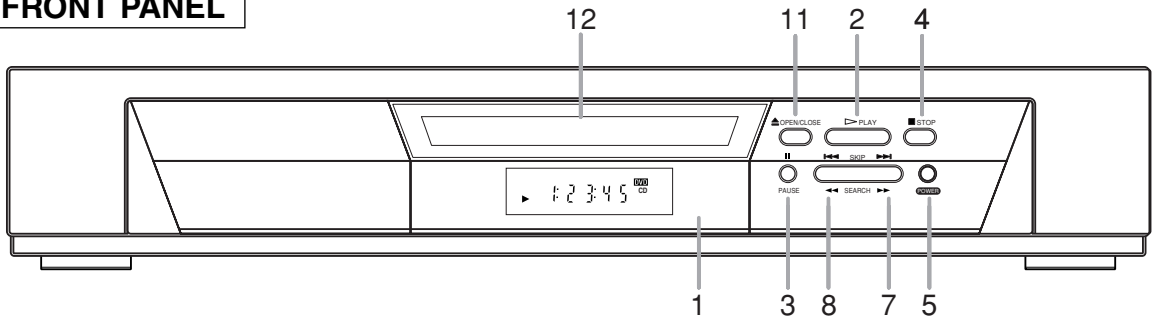

## REMOTE CONTROL

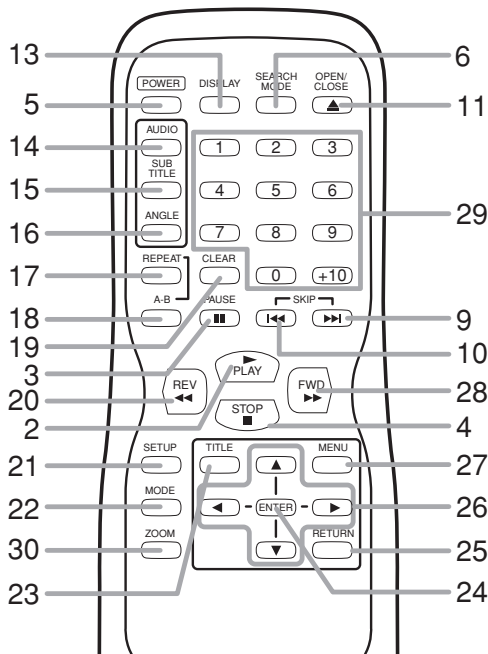

### 1. Display, Remote Sensor Window

### 2. PLAY Button [page 13]

Starts playback of the disc contents.

### 3. PAUSE Button [page 14]

Pauses the current disc operation.

### 4. STOP Button [page 14]

Stops operation of the disc.

### 5. POWER Button [page 13]

Press to turn the power on and off.

### 6. SEARCH MODE Button [pages 15,16]

Press to locate a desired point.

### 7. SKIP UP/FWD Button (main unit)

Plays back from the beginning of the next chapter or track. Hold down to fast forward playback.

### 8. SKIP DOWN/REV Button (main unit)

Plays back from the beginning of the current chapter or track. Hold down to fast reverse playback.

### 9. SKIP UP Button (remote control)

Plays back from the beginning of the chapter or track.

### 10. SKIP DOWN Button (remote control)

Plays back from the beginning of the current chapter or track.

### 11. OPEN/CLOSE Button [page 13]

Press to insert discs into or remove them from the tray.

### 12. Disc loading tray

### 13. DISPLAY Button [page 19,23]

Displays the current status on the TV screen for checking purposes.

### 14. AUDIO Button [page 21]

Press to select a desired audio language or sound mode.

### 15. SUBTITLE Button [page 22]

Press to select a desired subtitle language.

### 16. ANGLE Button [page 22]

Press to change the camera angle to see the sequence being played back from a different angle.

### 17. REPEAT Button [page 17]

Repeats playback of the current disc, title, chapter or track.

### 18. A-B REPEAT Button [page 17]

Repeats playback of a selected section.

### 19. CLEAR Button [pages 17]

Resets a setting.

### 20. REV Button

Fast reverse playback to a desired point.

### 21. SETUP Button [page 24]

Press to enter the setup mode or to change setup items.

### 22. MODE Button [pages 16]

Activates program playback or random playback mode when playing CDs or MP3. Sets Black level or SRS Tru surround.

### 23. TITLE Button [page 14]

Displays the title menu.

### 24. ENTER Button

Press to accept a setting.

### 25. RETURN Button

Returns to the previous operation.

### 26. Arrow Buttons

Use when making settings while watching the display on a TV screen.

### 27. MENU Button [page 13]

Displays the disc menus.

### 28. FWD Button [page 15]

Fast forwards playback to a desired point.

### 29. Numeric Buttons [page 15]

Enlarges part of a DVD-reproduced image.



## REAR VIEW

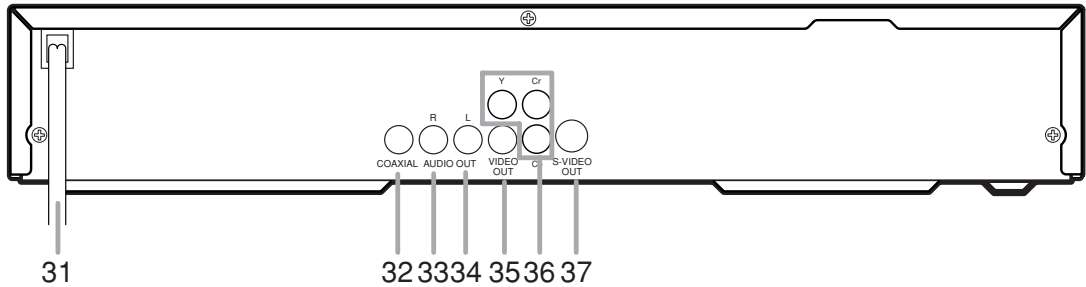

- 31. Power Cord
- 32. COAXIAL DIGITAL AUDIO OUT Jack
- 33. Right AUDIO OUT Jack
- 34. Left AUDIO OUT Jack

- 35. VIDEO OUT Jack
- 36. Component Video Out Jacks
- 37. S-VIDEO OUT Jack

## DISPLAY

Stays on when the A-B repeat function is on.

Stays on when the repeat function is on.

Lights up when a DVD is inserted on the tray.

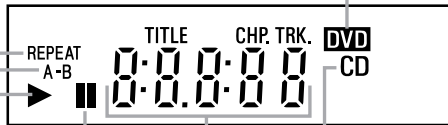

Lights up when the inserted disc comes to a pause.

Stays on when the inserted disc is being played back.

Displays how long a current title or track has been played back. When a chapter or track has switched, the number of a new title, chapter or track is displayed.

## DISPLAYS DURING OPERATION

	Power on
	No disc inserted
	Tray open
	Tray closed
	Loading the Disc
	Power off

## LOADING THE BATTERIES

1. Open the battery compartment cover.
2. Insert two AA batteries, with each one oriented correctly.
3. Close the cover.

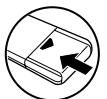
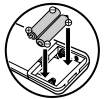

### Notes

- Do not mix alkaline and manganese batteries.
- Do not mix old and new batteries.

# HOOKUPS

## CONNECTING TO A TV

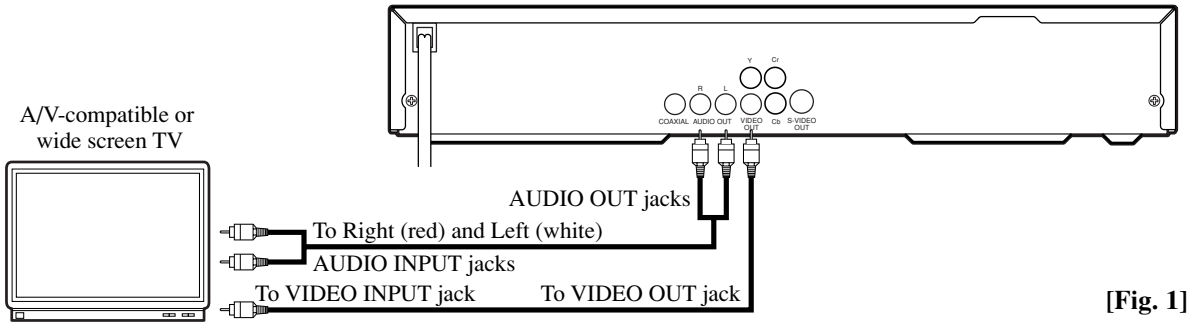

### FOR TVs WITH S-VIDEO INPUT JACK

Use an S-Video cable (commercially available) in place of the yellow video cable to enjoy pictures at higher quality.

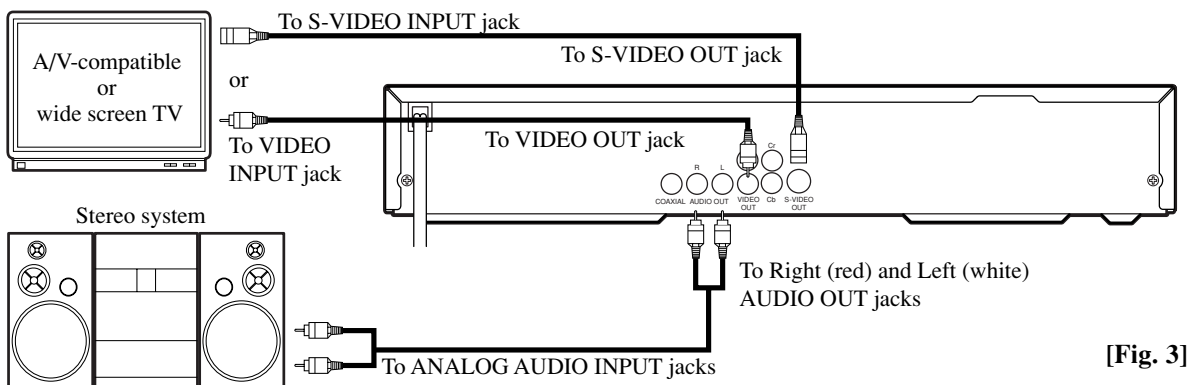
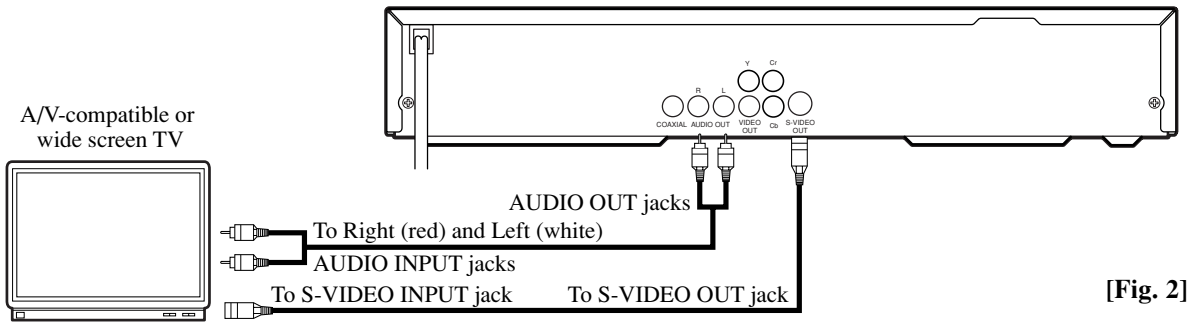

### Notes

- Connect the DVD player directly to a TV. If the A/V cables are connected to a VCR, pictures may be distorted due to the copy protection system.
- Be sure to turn off the power to all components in the system before connecting another component.
- Refer to the Owner's Manuals for your TV, stereo system and any other components to be connected to the DVD player.

## CONNECTING TO A DOLBY DIGITAL DECODER OR DTS DECODER

If using this DVD player to playback a DVD in a 5.1 channel Dolby Digital surround, DTS surround format, the DVD player outputs a Dolby Digital, or DTS data stream from its COAXIAL DIGITAL AUDIO OUT jack. By hooking the player up to a Dolby Digital or DTS decoder, you can enjoy a more convincing, realistic ambience with powerful and high-quality surround sound of a professional standard such as can be heard in movie theaters.

Use an audio coaxial digital cables (not included) for the audio connections.

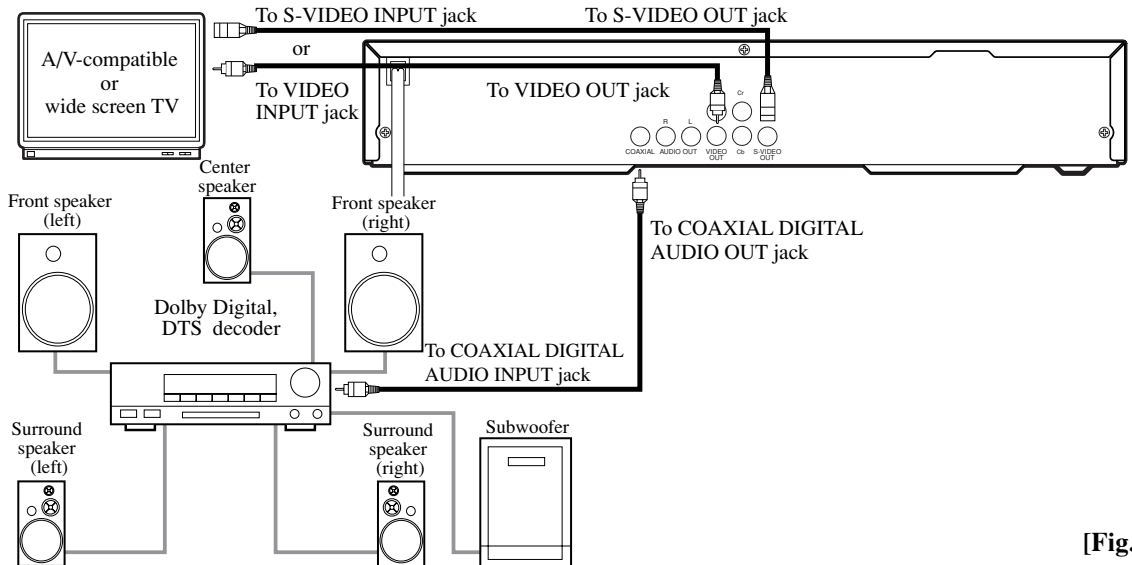

[Fig. 4]

### Notes

- Be sure to turn off the power to all components in the system before connecting another component.
- Refer to the Owner's Manuals for the components to be connected to the DVD player.
- If output Dolby Digital audio, connect to a Dolby Digital decoder, and set Dolby Digital to on for audio output in the setup mode.
- If output DTS audio, connect to a DTS decoder, and set DTS to ON for audio output in the setup mode.
- Unless connected to a Dolby Digital decoder, or a DTS decoder, set Dolby Digital or DTS to off for audio output in the setup mode. Playing a DVD using incorrect settings may generate noise distortion, and may also damage the speakers.

**“DTS” and “DTS Digital Out” are trademarks of Digital Theater Systems Inc.**

**Manufactured under license from Dolby Laboratories. “Dolby” and the double-D symbol are trademarks of Dolby Laboratories.**

## CONNECTING TO A TV OR A STEREO TV THAT HAS COMPONENT VIDEO IN JACKS

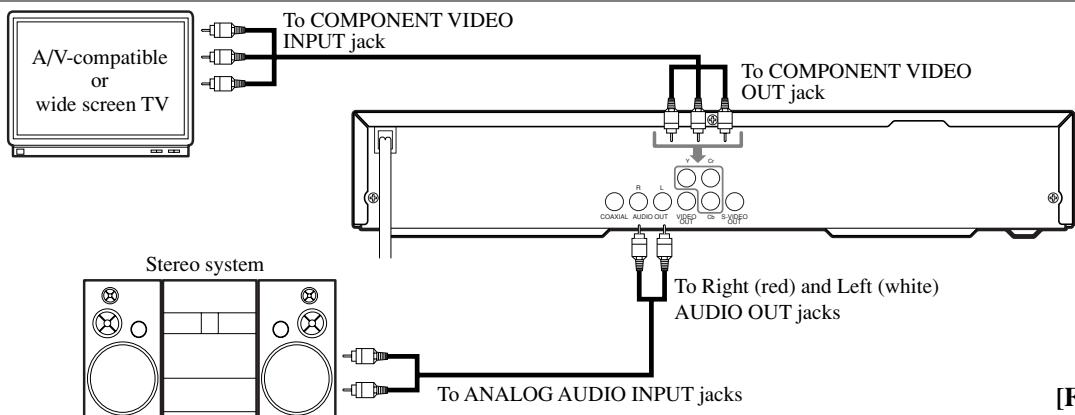

[Fig. 5]

## CONNECTING TO AN AMPLIFIER EQUIPPED WITH DIGITAL INPUT JACKS SUCH AS MD DECK OR DAT DECK

Use an audio coaxial digital cables (not included) for the audio connections.

Connecting to an amplifier equipped with digital input jacks such as MD Deck or Dat Deck.

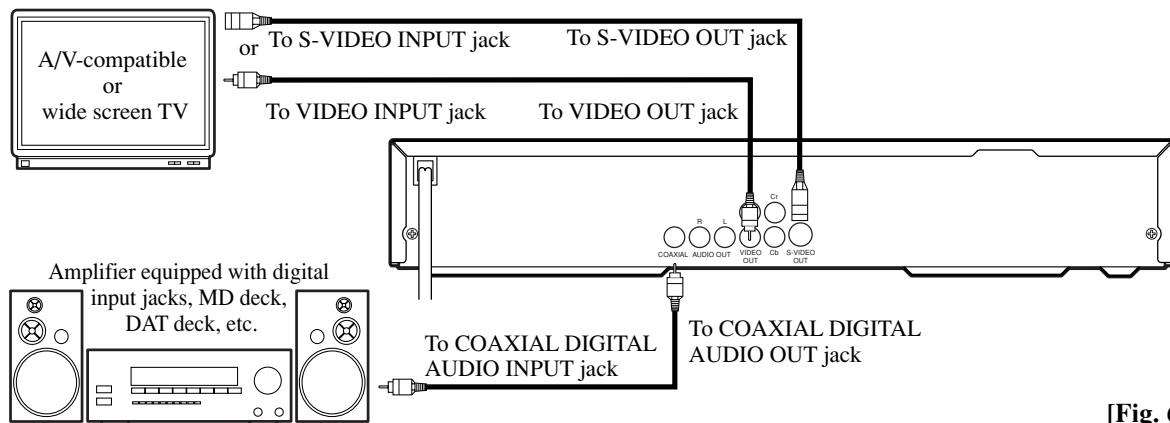

[Fig. 6]

### Notes

- The audio source on a disc in a 5.1 channel Dolby Digital surround format cannot be recorded as digital sound by an MD or DAT deck.
- Be sure to turn off the power to all components in the system before connecting another component.
- Refer to the Owner's Manuals for the components to be connected to the DVD player.
- Set Dolby Digital and DTS to off for audio output in the setup mode. Playing a DVD using incorrect settings may generate noise distortion, and may also damage the speakers. (See page 26 to set ON for Dolby Digital and DTS)

### **HOW TO CONNECT TO A TV WITHOUT AUDIO/VIDEO INPUT JACKS**

If your TV does not have RCA type audio and video input jacks it is still possible to connect this DVD player to your TV's 75-ohm coaxial antenna terminal using a commercially available Stereo Audio/Video RF Modulator. Connect the audio and video outputs of the DVD player to the audio and video inputs on the RF Modulator, and then connect the coaxial output of the RF Modulator (usually marked "TO TV") to the 75 ohm coaxial antenna terminal on your TV. Follow the instruction supplied with the RF Modulator for more details.

If your TV's 75 ohm coaxial antenna terminal is already occupied by an antenna or cable box connection, remove that cable from your TV's antenna terminal and reconnect it to the coaxial antenna input terminal of the RF Modulator (usually marked "ANT IN"), then connect the RF modulator to your TV's antenna terminal as described above.

### Note

- The picture quality from DVD discs will not be as good if the DVD player is connected to the TV's antenna terminal through an RF Modulator.

# PLAYING A DISC

## PLAYING A DVD VIDEO OR AN AUDIO CD

DVD

CD

### Getting started

Turn on the power of the TV, amplifier and any other components which are connected to the DVD player. (Change the input system to suit the DVD player, and check that the sound volume is correct.)

#### 1 Press the POWER button.

- The power will turn on.

#### 2 Press the OPEN/CLOSE button.

- The disc loading tray will open.

#### 3 Place a disc into the tray.

- Make sure the disc is sitting properly in the correct recess, with the label side up.

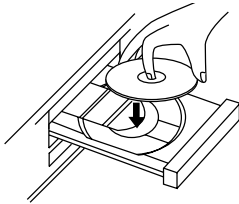

#### 4 Press the PLAY button.

- The tray will close automatically, and playback will then start from the first chapter or track of the disc. You need to press the PLAY button only when the tray has been closed by pressing the OPEN/CLOSE button.
- When you playback the DVD which a title menu is recorded, it may appear on the screen. In this case, refer to "USING THE TITLE MENU".

#### 5 Press the STOP button to stop play.

### Notes

- A "prohibited icon" may appear at the top-right on the TV screen during operation, warning that a prohibited operation has been encountered by the DVD player or the disc.
- If a disc is dirty or has scratches, the pictures may appear distorted and the playback operation may stop. In such cases, clean the disc and unplug the power cord and then plug it again before resuming playback.
- With DVDs that use some titles for playback program signals, playback may start from the second title, or it may skip these titles.
- During the playback of two layered disc, pictures may stop for a moment. This happens when the 1st layer switches to the 2nd layer. This is not a malfunction.

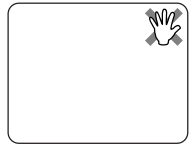

## USING THE DVD MENUS

DVD

Some DVDs contain their own menus, such as a guidance menu which describes the contents of the disc or a selection menu for sound, language and other customized settings.

#### 1 Press the MENU button.

- The DVD menu will appear.

#### 2 Select the desired title.

- Press the arrow buttons (▼/▲/▶/◀) to change the setting, and then press the ENTER button.

#### 3 Playback will start from the selected title.

## USING THE TITLE MENU

DVD

With a DVD containing a title menu, you can select desired titles from the menu.

### 1 Press the TITLE button.

- The title menu will appear.

### 2 Select the desired title.

- Press the arrow buttons (▼/▲/▶/◀) to change the setting, and then press the ENTER button.

## CALLING UP A MENU SCREEN DURING PLAYBACK

### For DVDs

- Press the MENU button to call up the DVD menu.
- Press the TITLE button to call up the title menu.

### Note

- Contents of menus and corresponding menu operations may vary between discs. Refer to the manual accompanying the disc for details.

## RESUMING PLAYBACK FROM THE POINT WHERE PLAYBACK STOPPED

DVD

CD

### 1 Press the STOP button during playback.

- Playback will stop, and then appear the resuming message at the center.

Press 'PLAY' to play from here.  
To play the beginning, press 'STOP' first  
and then 'PLAY'.

- ### 2 Press the PLAY button. Playback will start from the point where the previous playback session was stopped.

### Note

- The resume function can be reset by pressing the STOP button twice or by opening the disc loading tray.

## PAUSING PLAYBACK OR DISPLAYING A STILL PICTURE

DVD

CD

### 1 Press the PAUSE button during playback.

- Playback will pause, with sound muted.



### 2 Press the PLAY button to resume playback.



## STEPPING THROUGH FRAMES

DVD

### 1 Press the PAUSE button while playback is paused.

- The next picture frame is displayed with sound muted each time the button is pressed.



### 2 Press the PLAY button to resume playback.



## FAST FORWARD/REVERSE

DVD

CD

1 Press the FWD ►► or REV ◀◀ button during playback.

- For DVDs, pressing the FWD ►► or REV ◀◀ button cycles the playback speed in four steps. In case of DVDs, the sound will mute.
- For audio CDs, the playback speed is ×16 fixed.

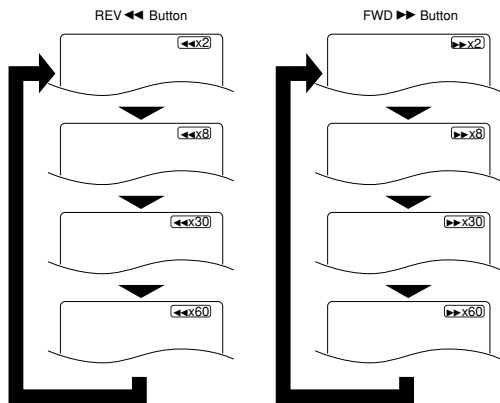

2 Press the PLAY button to return to normal playback speed.

## SLOW MOTION

DVD

1 Press the FWD ►► button while playback is paused. (Sound remains muted.)

- Slow motion mode will be activated.
- Pressing the FWD ►► button cycles the playback speed in three steps. Select an appropriate speed while referring to the speed indication on the screen.

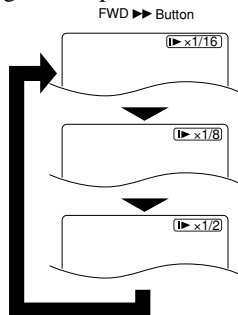

2 Press the PLAY button to return to normal playback speed.

### Notes

- Slow playback is not available with audio CDs.
- The reverse of slow playback is not available.

## STARTING FROM A DESIRED TRACK

CD

1 Press the numeric buttons to enter the desired track number.

- The selected track will be located, and playback will start.

You can also press the SEARCH MODE button, use the numeric buttons to enter the track number.



When the track number is entered in the entry box, playback of the desired track will start automatically.

### TRICKS WITH THE SKIP BUTTONS (◀◀, ►►)

If the SKIP button ►► is pressed during playback or while playback is paused, the current track will be skipped and the next track will be played. When the SKIP button ◀◀ is pressed once, the top of the current track will be located for replaying. When the SKIP button ◀◀ is pressed again within 2-seconds after playback begins, the previous track will be located.

## PLAYING FROM A DESIRED TITLE OR CHAPTER

DVD

1 Press the SEARCH MODE button and then press the numeric buttons to select a title or a chapter.

- Perform the title search and the chapter search after setting them on the same screen at the same time. Changeover by ▲/▼ buttons.
- During playback, press the numeric buttons to select a Chapter. The Chapter will be located and playback will start.
- When playback is stopped, press the numeric buttons to select a Title. The Title will be located and playback will start.

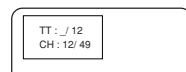
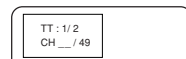

### Notes

- Playback from a desired title or chapter is not available with some DVDs.
- Some discs which the chapter number isn't displayed cannot playback from a desired chapter.

### TRICKS WITH THE SKIP BUTTONS (◀◀, ►►)

If the SKIP button ►► is pressed during playback or while playback is paused, the current chapter will be skipped and the next chapter will be played. When the SKIP button ◀◀ is pressed once, the top of the current chapter will be located for replaying. When the SKIP button ◀◀ is pressed again within 2-seconds after playback begins, the previous chapter will be located.

## STARTING FROM A DESIRED TIME COUNT

DVD

CD

1 Press the SEARCH MODE button twice.

2 Press the numeric buttons to set the desired time count.

- **Example:** 1 hour, 23 minutes and 30 seconds  
1 → 2 → 3 → 3 → 0

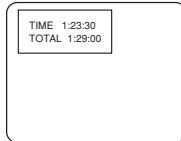

### Notes

- In the case of DVD, Time Search in Title is effective. (But Time Search in Chapter is ineffective.)
- In the case of CD, Time Search in Track is effective. (But Time Search in the entire disc is ineffective.)
- Playback from a desired time count is not available with some discs or if the unit is in stop mode.
- If wrong numbers are entered, press the CLEAR button and re-enter the correct numbers.

## MARKER

DVD

CD

You can define the part to be called back.

1 Press the SEARCH MODE button three times during playback.

### Set the marker

- Using the cursor (◀/▶) button, position the cursor on to the marker number shown as “NOT SET”. Press the ENTER button when the screen to be reviewed appears. The marked time will be displayed. Up to 5 points can be marked.

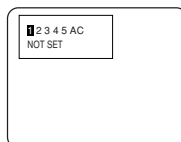

### Call back the marker

- Using the cursor (◀/▶) button, position the cursor on to the marker number to be called back and press the ENTER button.

### Clear the marker

- Using the cursor (◀/▶) button, position the cursor on to the marker number to be cleared and press the CLEAR button.  
To clear all markers, place the cursor on “AC” (All clear markers) and press the ENTER button.

2 Press the SEARCH MODE button or the RETURN button to exit the display.

## RANDOM (Audio CD)

CD

1 Press the MODE button in stop mode.

- The program setting menu screen will appear.

2 Press the MODE button again.

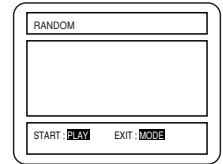

3 Press the PLAY button. Random playback will then start.

### Note

- Program playback is not available during random playback.



# REPEAT

DVD

CD

## 1 Press the REPEAT button.

### For DVDs

- A single title or chapter is played back repeatedly.
- Pressing the REPEAT button cycles the display on the screen as follows.

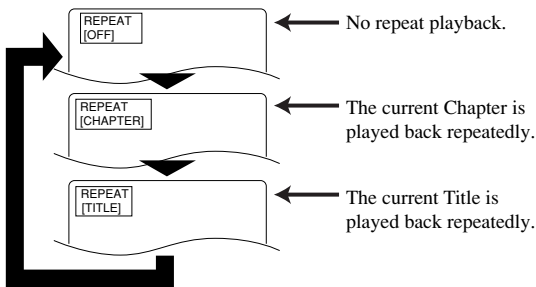

### For audio CDs

- The whole disc or a single track is played back repeatedly.
- Pressing the REPEAT button cycles the display on the screen through **Off, Track and All**.

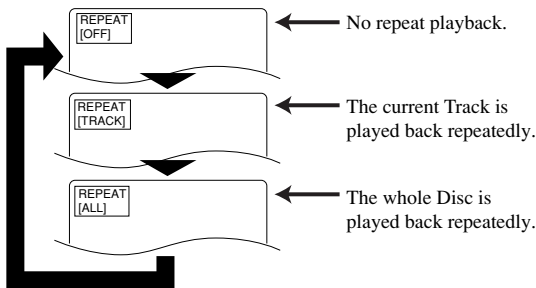

**If the REPEAT button is pressed once during program/random playback, the current track is played back repeatedly.**

**If the REPEAT button is pressed again, the program/random playback is performed repeatedly.**

### Notes

- Repeat playback is not available with some discs.
- The REPEAT setting will be cleared when moving to other title, chapter or track.
- Repeat playback does not function during A-B repeat playback.

# A-B REPEAT

DVD

CD

You can define a section to be played back repeatedly.

## 1 Press the A-B REPEAT button during playback.

- The starting point (A) will then be selected.

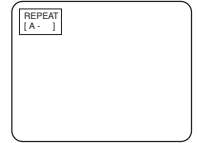

## 2 Press the A-B REPEAT button again at the end point (B) of the desired section.

- The selected section will be played back repeatedly.

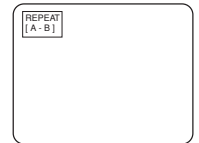

## 3 To exit A-B repeat playback, press the A-B REPEAT button and set it to OFF.

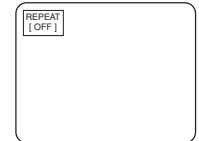

### Notes

- With DVDs, the A-B repeat section can be set only within the current title.
- With audio CDs, the A-B repeat section can be set within the current track.
- A-B repeat is not available with some scenes in DVD.
- To cancel the A point which was set, press the CLEAR button.
- A-B repeat playback is not function during title, chapter, track or all repeat playback had set.

## PROGRAM (Audio CD)

CD

### 1 Press the MODE button in stop mode.

- The program screen will appear.

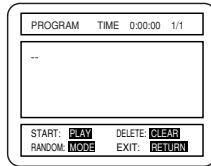

### 2 Press the numeric buttons to enter the desired track numbers.

- 50 programs can be displayed at once on the screen. Press “▼” to go to the next page.

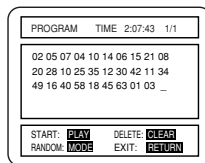

### 3 Press the PLAY button.

- Playback will start in the programmed order.
- While the program is being played back, the STOP button works as follows.
- Press the STOP button once and then the PLAY button again, playback will restart from the point where the STOP button was pressed. (Program continued)
- Press the STOP button twice and then the PLAY button again, playback will restart from the track in the usual way. (Program cleared)

### Notes

- Adding programs is not possible during program playback. You must stop the current playback before such operations can be carried out.
- Press the CLEAR button to cancel a program. The most recently entered program will then be deleted.
- Up to 99 programs can be entered.
- Playback from a desired track and random playback are not available during program playback.
- Program settings are cleared when the power is turned off or the disc loading tray is opened.
- Press the MODE button to check the programmed setting.

## ZOOM PLAYBACK (enlargement onscreen)

DVD

Images can be enlarged on the screen to your taste.

### 1 Press the ZOOM button during playback.

- An image will be enlarged at the center of the screen.
- Pressing the ZOOM button cycles the zooming images in two steps.



2 When the cursor (▲/▼/◀/▶) button is pressed during zoom play, the part to be zoomed moves.

- The zooming frame can be moved from the center .... 4 steps to the right. 4 steps to the left. 4 steps to the top. 4 steps to the bottom when 2time zooming. The frames will move 6steps when 4 time zooming.
- Current position will be displayed on the right-bottom of the screen. Press the ENTER button, and the display disappears.

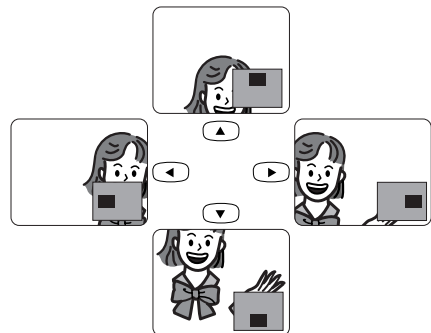

### Note

- Zooming function does not work while disc menu is shown.

# PLAYING AN MP3 DISC

MP3

## 1 Insert an MP3 file-recorded disc.

- The MP3 menu screen shows up.
- Folders are referred to as “ALBUMS” and files are referred to as “TRACKS”.
- “+” appears at the beginning of the album name.

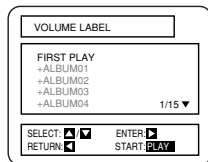

- If all the TRACKS cannot be displayed at once on the screen, “▼” appears to go to the next page. If there is a previous page, “▲” appears on-screen. On the left of “▼”, the current page and the total number of pages are displayed.
- The player can recognize 255 ALBUMS and TRACKS altogether.

## 2 Using the ▲/▼ buttons, select a ALBUM or TRACKS to be played.

### [When TRACKS are selected]

The TRACKS will be played in the order of selection.

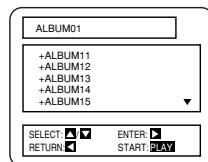

### [When an ALBUM is selected]

Press the ► button. The TRACK selection screen shows up. Using the ▲/▼ buttons, select TRACKS to be played.

- Choose “FIRST PLAY”, and the ALBUMS and TRACKS will be played from the beginning of the disc.
- Press the TITLE button, and the top hierarchy will be called back.
- ALBUMS can be played up to the 8th hierarchy.

## 3 Press the PLAY button.

- Playback will start.

## 4 To stop play, press the STOP button.

# CHANGING THE ONSCREEN DISPLAY DURING MP3 DISC PLAY

MP3

The information on an MP3 disc in play can be checked.

## 1 Press the DISPLAY button during playback.

- The TRACK currently in play will be highlighted.

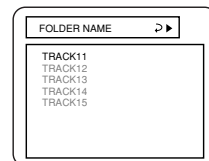

## 2 Press the DISPLAY button again.

- The ALBUM name being displayed will be replaced by the elapsed time of the track.
- [Repeat icon] will be displayed when the repeat play has been selected.

- ▶ A : Album (folder) repeat
- ▶ T : Track repeat
- ▶ D : Disc repeat

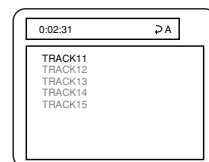

## 3 Press the DISPLAY button again, and the display screen disappears.

## PLAYING AN MP3 DISC FROM A DESIRED TRACK

MP3

1 Press the **SEARCH MODE** button during play back.

- The **SEARCH** menu shows up.
- The Track currently in play or under **RESUME ON** will be highlighted. In the case of **RESUME OFF**, the first track of the disc will be highlighted.
- Press the **RETURN** button, and the **SEARCH** menu disappears.

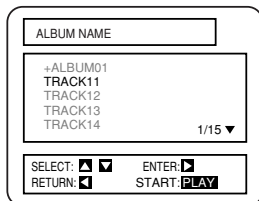

2 Using the **▲/▼** buttons, select a track to be played. Then press the **PLAY** button to start playing.

### Notes

- During play, a desired track can be directly searched. Just type in the **TRACK** number with the numeric buttons.
- If the typed **TRACK** number is not available, the “disable” symbol appears and the direct search mode is cancelled.
- Playback cannot be started from a desired time count.

## PLAYING AN MP3 DISC AT RANDOM

MP3

1 Press the **MODE** button twice in **STOP** mode.

- The random setting menu screen will appear.

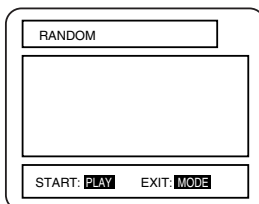

2 Press the **PLAY** button.

- Random play starts.

## PLAYING AN MP3 DISC IN A PROGRAMMED WAY

MP3

1 Press the **MODE** button in **STOP** mode.

- The program screen shows up.

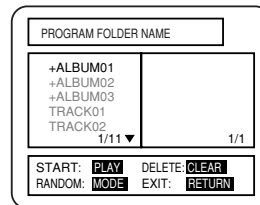

2 Using the **▲/▼** buttons, select a track. Then press the **ENTER** button to save it in a program.

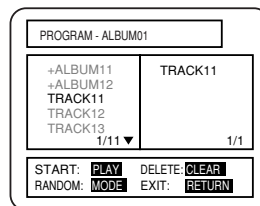

- The programmed track is displayed in the right-hand screen.
- When the **◀** button is pressed, the album atop in the current left-hand screen will be highlighted.
- If the entire program cannot be displayed at once on the screen, “▼” appears to go to the next page.

3 When the disc has been programmed, press the **PLAY** button.

- Programmed play starts.

### Notes

- Press the **CLEAR** button, and the last-programmed entry will be deleted.
- Press the **RETURN** button, and the **STOP** screen will show up with the program contents in memory.
- The program settings will be cancelled when the power is turned off or the disc tray is opened.

# SETTINGS

## CHANGING THE AUDIO LANGUAGE OR SOUND MODE

DVD CD

The DVD player has a function which allows you to select the desired audio language and sound mode.

### For DVDs

Press the **AUDIO** button during playback, and then press the **AUDIO** button to select the desired audio language.

- The audio language can be changed if multiple languages are recorded on the DVD being played.

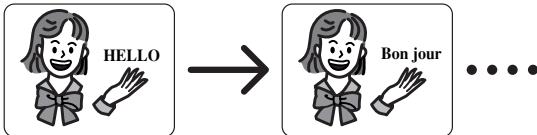
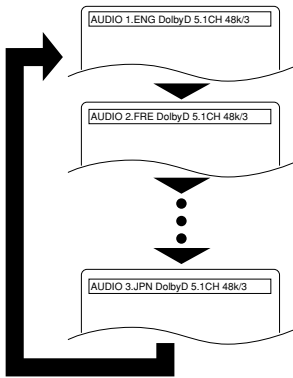

### Notes

- Pressing the Audio button may not work on some DVDs with multiple audio languages (e.g. DVDs which allow audio language setting on the disc menu). Operation varies between discs, so refer to the manual accompanying the disc.
- Current audio language and sound mode will be displayed when you press the **AUDIO** button at first.
- If a desired language is not shown after pressing the Audio button several times, the disc does not have an audio source in that language.
- The audio language resets to the one which has been selected in the setup mode, every time the power is turned on or discs are replaced. If that language is not available on a disc, a language defined by the disc is selected.
- The screen display will disappear after about 5 seconds.
- If you use **DIGITAL AUDIO OUT** jack, the sound mode of audio CDs can not be changed.

### For audio CDs

Press the **AUDIO** button during playback.

- Pressing the **AUDIO** button cycles the sound mode through **STEREO**, **L-CH** and **R-CH**.

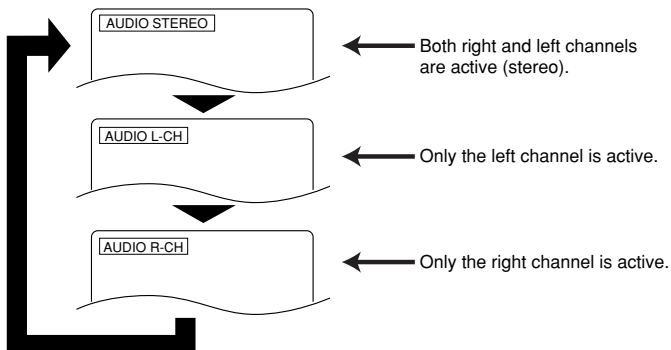

# CHANGING THE SUBTITLE LANGUAGE

DVD

The DVD player has a function which allows you to select the desired language for subtitles.

1 Press the **SUBTITLE** button during playback, and then press the **SUBTITLE** button to select the desired subtitle language.

- The subtitle language can be changed if the subtitles are recorded in multiple languages on the DVD being played.
- The subtitle language cannot be changed if the subtitles are recorded in a single language on the DVD being played.

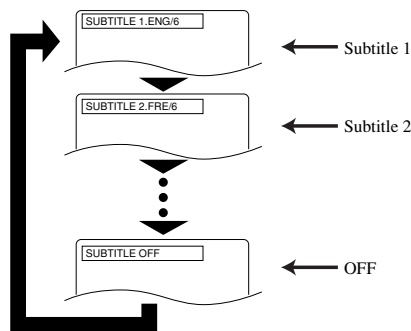

- Pressing the **SUBTITLE** button cycles the subtitle language from **SUBTITLE 1**, **SUBTITLE 2** and all the languages recorded.
- Current subtitle mode will be displayed when you press the **SUBTITLE** button at first.
- Press the **SUBTITLE** button, and then press the cursor (**◀/▶**) button to set it to on or off.

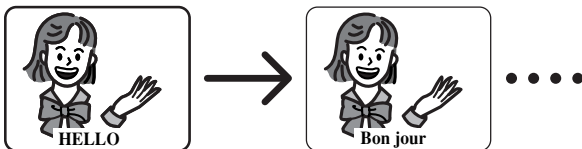

## Notes

- Some discs allow subtitle language setting on the disc menu. (Operation varies between discs, so refer to the manual accompanying the disc.)
- If the desired language is not shown after pressing the **SUBTITLE** button several times, the disc does not have subtitles in that language.
- The subtitle language resets to the one which has been selected in the setup mode, every time the power is turned on or discs are replaced. If that language is not available on a disc, a language defined by the disc is selected.

- It may take time to display the subtitles in the selected language.
- The screen display will disappear after about 5 seconds.
- When “**SUBTITLE NOT Available**” appears on-screen, it means no subtitle is recorded on the scene.

# CHANGING THE CAMERA ANGLE (Multi-Angle Pictures)

DVD

The DVD player has a function which allows you to select the desired camera angle.

1 Press the **ANGLE** button during playback.

- If the disc contains sequences recorded from different camera angles, the angle icon (  ) will appear at the top-right of the screen. You can change the camera angle when the icon appears on the screen.
- The camera angle cannot be changed if the disc does not contain sequences recorded from different camera angles.

2 Press the **ANGLE** button while the angle number is shown on the screen.

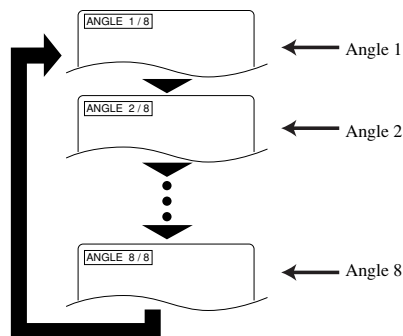

## Notes

- The screen display will disappear after about 5 seconds.
- Current camera angle will be displayed when you press the **ANGLE** button at first.

# CHANGING THE ON-SCREEN DISPLAY

DVD

CD

You can check the information about the disc by pressing the DISPLAY button on the remote control.

## For DVDs

1 Press the DISPLAY button during playback.

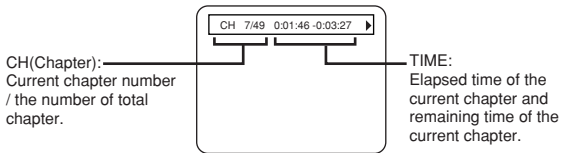

2 Press the DISPLAY button again.

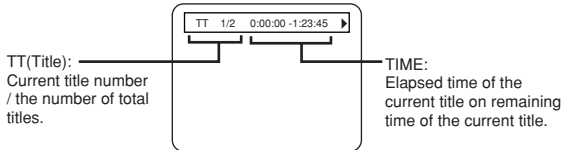

• Use the number button to start from a desired chapter.

3 Press the DISPLAY button again.

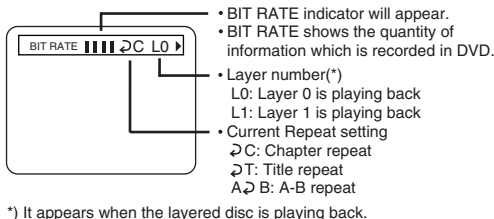

4 Press the DISPLAY button or the RETURN button to exit the display.

## For audio CDs, video CDs

1 Press the DISPLAY button during playback.

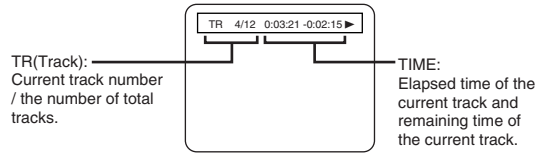

2 Press the DISPLAY button again.

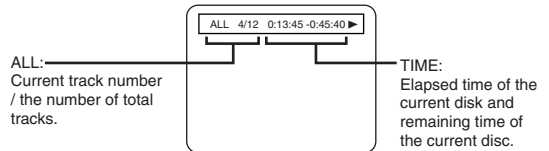

• Use the number button to start from a desired track.

3 Press the DISPLAY button or the RETURN button to exit the display.

## BLACK LEVEL SETTINGS

DVD

You can set to make the black parts of the picture brighter.

1 Press the MODE button during playback.

• The setup screen will appear.

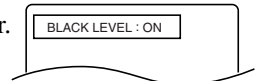

2 Press the ENTER button to set it on or off.

- ON : It makes the dark parts brighter.(Default : ON)
- OFF : Original picture which is recorded on the disc will be shown.
- Press the RETURN button to exit the display.

## TruSurround SETTINGS

You can enjoy stereophonic sound system when you playback Dolby Digital and PCM 48kHz sound.

1 Press the MODE button twice during playback.

• The setup screen will appear.

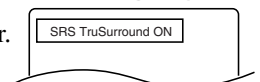

2 Press the ENTER button to turn it on or off.

- ON : TruSurround On. (Default : off)
- OFF : TruSurround Off.
- Press the DISPLAY button or the RETURN button to exit the display.

# CHANGING THE SETUP ITEMS

## LANGUAGE SETTINGS

1 Press the **SETUP** button in **STOP** mode.

- The setup screen will appear.

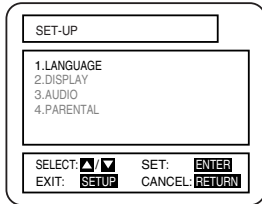

2 Press the **▲/▼** buttons to select Language, and then press the **ENTER** button.

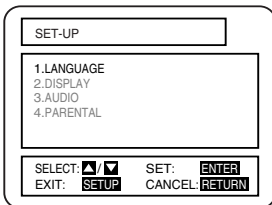

3 Press the **▲/▼** buttons to select an item, and then press the **ENTER** button.

### AUDIO:

(Voice is played back in selected language.)

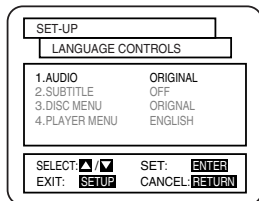

### SUBTITLE:

(Subtitles are shown in selected language.)

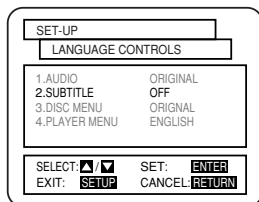

### DISC MENU:

(The disc menu appears in selected language.)

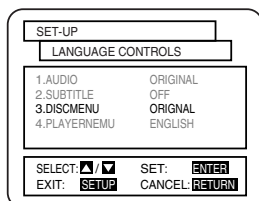

### PLAYER MENU:

(The on-screen display appears in selected language.)

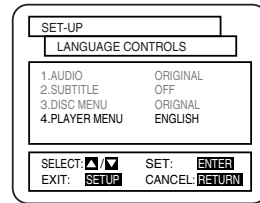

4 Press the **▲/▼** buttons to select a desired item, and then press the **ENTER** button.

- If "OTHER" is selected on the Audio, Subtitle or Disc Menu setting screen, the Language Code setting screen will appear. Press the numeric buttons to enter the desired language code while referring to the list on page 28.

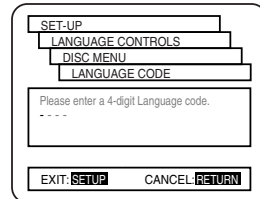

5 Press the **SETUP** button.

- The setup mode will be canceled and the ordinary screen will appear.

### Notes

- Be sure to press the **SETUP** button, or the setting will not work.
- Language Setting for Audio and Subtitle is not available with some discs. Then use the Audio and Subtitle button. Details are on pages 21 and 22.
- You can also select the item by pressing the numbers which displayed with the item.
- When you change the setup items, press the **STOP** button if you are in playback mode.



# DISPLAY SETTINGS

## 1 Press the SETUP button in STOP mode.

- The setup screen will appear.

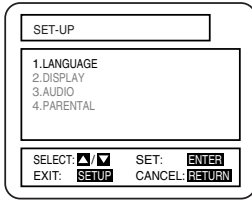

## 2 Press the ▲/▼ buttons to select DISPLAY and then press the ENTER button.

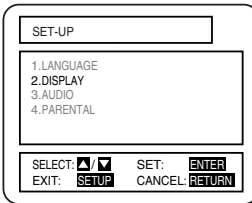

## 3 Press the ▲/▼ buttons to select an item, and then press the ENTER button.

### TV ASPECT (Default : 4:3 LETTER BOX)

4:3 LETTER BOX : Wide screen with black bars on top and bottom

4:3 PAN & SCAN : Full height picture, trimmed both sides

16:9 WIDE : If wide screen TV is connected

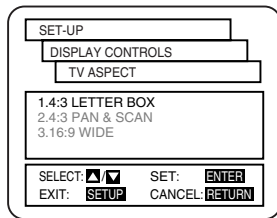
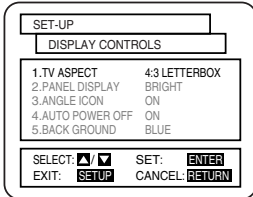

### PANEL DISPLAY (Default : Bright)

Adjust the brightness of the display of the unit.

Auto: Stays dim only during playback.

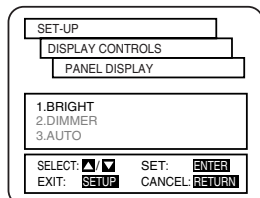
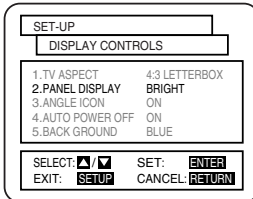

### ANGLE ICON (Default : ON)

Display or not display the Angle icon on the screen.

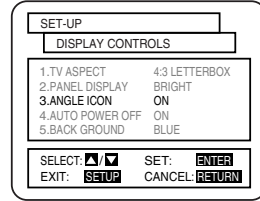

### AUTO POWER OFF (Default : ON)

Set or not set to turn off after the screen saver is started and no keys are pressed for 35 minutes.

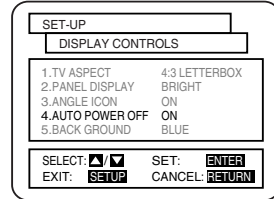

### BACKGROUND COLOR (Default : BLUE)

Select blue or gray.

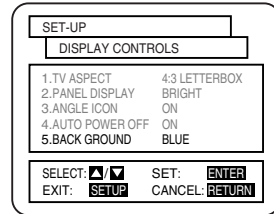

## 4 Press the ▲/▼ buttons to select a desired item, and then press the ENTER button.

## 5 Press the SETUP button.

- The setup mode will be canceled and the ordinary screen will appear.

### Notes

- Be sure to press the SETUP button, or the setting will not work.
- You can also choose the item by pressing the numbers.

# AUDIO SETTINGS

## 1 Press the **SETUP** button in **STOP** mode.

- The setup screen will appear.

## 2 Press the **▲/▼** buttons to select **Audio** and then press the **ENTER** button.

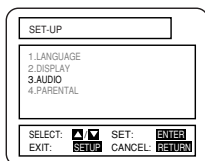

## 3 Press the **▲/▼** buttons to select an item, and then press the **ENTER** button.

### DRC (Default : OFF)

On : DRC

(Dynamic Range Control)

- This function is for controlling the range of sound volume. By compressing the range of sound volume, it is possible not only to suppress the output of loud sound at night and but also to raise the volume of low sound.
- This function is effective only for the sound recorded by Dolby Digital recording.

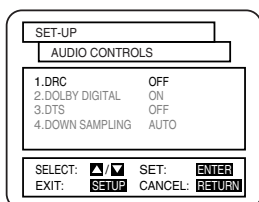

### Dolby Digital (default : ON)

On : Output by Dolby Digital

Set to On when the unit is connected to Dolby Digital Decoder.

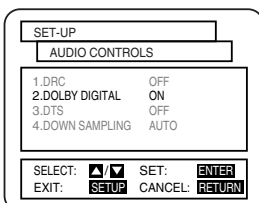

### DTS (Default : Off)

On : Output DTS sound

Set to On when the unit is connected to DTS Decoder.

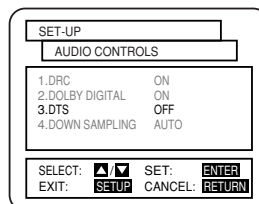

### Down Sampling (Default : Auto)

Set the output for the DVD recorded in PCM 96kHz (96kHz or 48kHz)

- Press the **▲/▼** buttons to select an item, and then press the **ENTER** button.

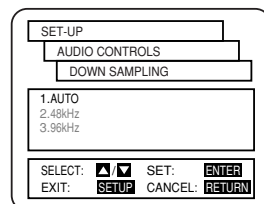
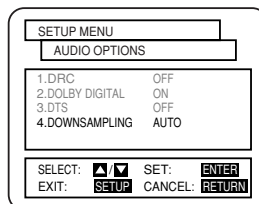

### When playing a disc with copyright protection

- If you select 96KHz, copyright protection will be activated and no sound will come out. If you select AUTO, sound will be down sampled at 48KHz.

## 4 Press the **SETUP** button.

- The setup mode will be canceled and the ordinary screen will appear.

# PARENTAL LOCK

## 1 Press the SETUP button in STOP mode.

- The setup screen will appear.

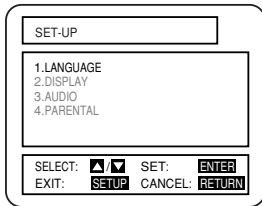

## 2 Press the ▲/▼ buttons to select PARENTAL, and then press the ENTER button.

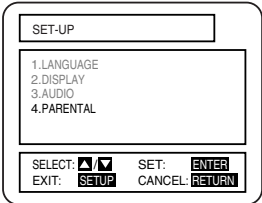

## 3 Press the numeric buttons to enter the 4-digit password, and then press the ENTER button.

- When doing this for the first time, enter any 4 digits. (except for 4737) That number will be used as the password from the second time onward.
- By entering the password, you can then change the control level and password settings.
- When CHANGE is selected, press the numeric buttons to enter the 4 digit password. Then press the ENTER button.

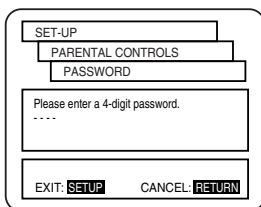

## 4 Press the ▲/▼ buttons to select an item, and then press the ENTER button.

## When Parental Level is selected

- Press the ▲/▼ buttons to select an item from “ALL” or 8 to 1 and then press the ENTER button.

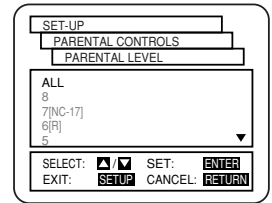
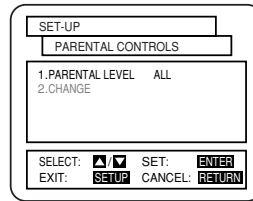

## 5 Press the SETUP button.

- The setup mode will be canceled and the ordinary screen will appear.

## CONTROL LEVELS

- **ALL**  
All parental lock is cancelled.
- **Level 8**  
DVD software of any grade (adult/general/children) can be played back.
- **Levels 7 to 2**  
Only DVD software intended for general use and children can be played back.
- **Level 1**  
Only DVD software intended for children can be played back, with those intended for adult and general use prohibited.

## Notes

- With some DVDs, it may be difficult to find if they are compatible with parental lock. Be sure to check if the parental lock function operates in the way that you have set.
- Record the password in case you forget it.

## IF YOU FORGET THE PASSWORD

- 1) Press the 4, 7, 3, 7 at step 3.
- Password will be cleared and parental level will be set to ALL.
- 2) Proceed the above steps 3-5 again.

# LANGUAGE CODE LIST

No.	Language	Country code	No.	Language	Country code
1	Afar	4 7 4 7	69	Latvian;Lettish	5 8 6 8
2	Abkhazian	4 7 4 8	70	Malagasy	5 9 5 3
3	Afrikaans	4 7 5 2	71	Maori	5 9 5 5
4	Amharic	4 7 5 9	72	Macedonian	5 9 5 7
5	Arabic	4 7 6 4	73	Malayalam	5 9 5 8
6	Assamese	4 7 6 5	74	Mongolian	5 9 6 0
7	Aymara	4 7 7 1	75	Moldavian	5 9 6 1
8	Azerbaijani	4 7 7 2	76	Marathi	5 9 6 4
9	Bashkir	4 8 4 7	77	Malay	5 9 6 5
10	Byelorussian	4 8 5 1	78	Maltese	5 9 6 6
11	Bulgarian	4 8 5 3	79	Burmese	5 9 7 1
12	Bihari	4 8 5 4	80	Nauru	6 0 4 7
13	Bislama	4 8 5 5	81	Nepali	6 0 5 1
14	Bengali;Bangla	4 8 6 0	82	Dutch	6 0 5 8
15	Tibetan	4 8 6 1	83	Norwegian	6 0 6 1
16	Breton	4 8 6 4	84	Occitan	6 1 4 9
17	Catalan	4 9 4 7	85	(Afan)Oromo	6 1 5 9
18	Corsican	4 9 6 1	86	Oriya	6 1 6 4
19	Czech	4 9 6 5	87	Panjabi	6 2 4 7
20	Welsh	4 9 7 1	88	Polish	6 2 5 8
21	Danish	5 0 4 7	89	Pashto;Pushto	6 2 6 5
22	German	5 0 5 1	90	Portuguese	6 2 6 6
23	Bhutani	5 0 7 2	91	Quechua	6 3 6 7
24	Greek	5 1 5 8	92	Rhaeto-Romance	6 4 5 9
25	English	5 1 6 0	93	Kirundi	6 4 6 0
26	Esperanto	5 1 6 1	94	Romanian	6 4 6 1
27	Spanish	5 1 6 5	95	Russian	6 4 6 7
28	Estonian	5 1 6 6	96	Kinyarwanda	6 4 6 9
29	Basque	5 1 6 7	97	Sanskrit	6 5 4 7
30	Persian	5 2 4 7	98	Sindhi	6 5 5 0
31	Finnish	5 2 5 5	99	Sangho	6 5 5 3
32	Fiji	5 2 5 6	100	Serbo-Croatian	6 5 5 4
33	Faroese	5 2 6 1	101	Singhalese	6 5 5 5
34	French	5 2 6 4	102	Slovak	6 5 5 7
35	Frisian	5 2 7 1	103	Slovenian	6 5 5 8
36	Irish	5 3 4 7	104	Samoan	6 5 5 9
37	Scots Gaelic	5 3 5 0	105	Shona	6 5 6 0
38	Galician	5 3 5 8	106	Somali	6 5 6 1
39	Guarani	5 3 6 0	107	Albanian	6 5 6 3
40	Gujarati	5 3 6 7	108	Serbian	6 5 6 4
41	Hausa	5 4 4 7	109	Siswat	6 5 6 5
42	Hindi	5 4 5 5	110	Sesotho	6 5 6 6
43	Croatian	5 4 6 4	111	Sundanese	6 5 6 7
44	Hungarian	5 4 6 7	112	Swedish	6 5 6 8
45	Armenian	5 4 7 1	113	Swahili	6 5 6 9
46	Interlingua	5 5 4 7	114	Tamil	6 6 4 7
47	Interlingue	5 5 5 1	115	Telugu	6 6 5 1
48	Inupiak	5 5 5 7	116	Tajik	6 6 5 3
49	Indonesian	5 5 6 0	117	Thai	6 6 5 4
50	Icelandic	5 5 6 5	118	Tigrinya	6 6 5 5
51	Italian	5 5 6 6	119	Turkmen	6 6 5 7
52	Hebrew	5 5 6 9	120	Tagalog	6 6 5 8
53	Japanese	5 6 4 7	121	Setswana	6 6 6 0
54	Yiddish	5 6 5 5	122	Tonga	6 6 6 1
55	Javanese	5 6 6 9	123	Turkish	6 6 6 4
56	Georgian	5 7 4 7	124	Tsonga	6 6 6 5
57	Kazakh	5 7 5 7	125	Tatar	6 6 6 6
58	Greenlandic	5 7 5 8	126	Twi	6 6 6 9
59	Cambodian	5 7 5 9	127	Ukrainian	6 7 5 7
60	Kannada	5 7 6 0	128	Urdu	6 7 6 4
61	Korean	5 7 6 1	129	Uzbek	6 7 7 2
62	Kashmiri	5 7 6 5	130	Vietnamese	6 8 5 5
63	Kurdish	5 7 6 7	131	Volapuk	6 8 6 1
64	Kirghiz	5 7 7 1	132	Wolof	6 9 6 1
65	Latin	5 8 4 7	133	Xhosa	7 0 5 4
66	Lingala	5 8 6 0	134	Yoruba	7 1 6 1
67	Laothian	5 8 6 1	135	Chinese	7 2 5 4
68	Lithuanian	5 8 6 6	136	Zulu	7 2 6 7

# TROUBLESHOOTING GUIDE

If the DVD player does not perform properly when operated as instructed in this Owner's Manual, check the player, consulting the following checklist.

Symptom	Cause	Remedy
No power	<ul style="list-style-type: none"> <li>● Loose power plug.</li> </ul>	<ul style="list-style-type: none"> <li>● Insert the power plug firmly into the wall outlet.</li> </ul>
The player does not respond to the remote control.	<ul style="list-style-type: none"> <li>● The remote control is not aimed at the sensor on the player.</li> <li>● Obstacles present between the remote control and the sensor.</li> <li>● The remote control is too far away from the player.</li> <li>● Dead batteries.</li> </ul>	<ul style="list-style-type: none"> <li>● Aim the remote control directly at the sensor on the player.</li> <li>● Remove the obstacles from the signal path.</li> <li>● Use the remote control within 7m of the player.</li> <li>● Replace the batteries.</li> </ul>
No picture	<ul style="list-style-type: none"> <li>● Loose video connection.</li> <li>● Wrong disc.</li> </ul>	<ul style="list-style-type: none"> <li>● Connect the video cables firmly.</li> <li>● Insert a correct video disc that plays on this player.</li> </ul>
Disc cannot be played	<ul style="list-style-type: none"> <li>● No disc.</li> <li>● Dirty disc.</li> <li>● Disc is placed upside down.</li> <li>● Parental lock is active.</li> </ul>	<ul style="list-style-type: none"> <li>● Insert a disc.</li> <li>● Clean the disc.</li> <li>● Place the disc correctly, with the label side up.</li> <li>● Cancel the parental lock or change the control level.</li> </ul>
No sound	<ul style="list-style-type: none"> <li>● Loose audio connection.</li> <li>● The power of the connected audio component is off.</li> <li>● Wrong audio output settings.</li> <li>● Wrong input settings on the connected audio component.</li> </ul>	<ul style="list-style-type: none"> <li>● Connect the audio cables firmly.</li> <li>● Turn the power of the audio component on.</li> <li>● Correct the audio output settings.</li> <li>● Correct the input settings on the audio component.</li> </ul>
Distorted picture	<ul style="list-style-type: none"> <li>● Copy protection is active.</li> <li>● Immediately after playing, press fast forward or in reverse.</li> <li>● The 1st layer is switching to the 2nd layer, when playing a two layered disc.</li> </ul>	<ul style="list-style-type: none"> <li>● Connect the player directly to the TV.</li> <li>● There are some cases where pictures may be slightly distorted, which are not a sign of a malfunction.</li> <li>● Although Pictures may stop for a moment, this is not a malfunction.</li> </ul>
Audio or subtitle language does not match the setup.	<ul style="list-style-type: none"> <li>● The selected language is not available for audio or subtitles on the DVD.</li> </ul>	<ul style="list-style-type: none"> <li>● No malfunction.</li> </ul>
The camera angle cannot be changed.	<ul style="list-style-type: none"> <li>● The DVD does not contain sequences recorded from different camera angles.</li> </ul>	<ul style="list-style-type: none"> <li>● No malfunction.</li> </ul>
Audio or subtitle language cannot be changed.	<ul style="list-style-type: none"> <li>● The DVD does not contain audio source or subtitles in the selected language.</li> </ul>	<ul style="list-style-type: none"> <li>● No malfunction.</li> </ul>
“Prohibited icon” appears on the screen, prohibiting an operation.	<ul style="list-style-type: none"> <li>● That operation is prohibited by the player or disc.</li> </ul>	<ul style="list-style-type: none"> <li>● No malfunction.</li> </ul>

## Notes

Some functions are not available in specific modes, but this is not a malfunction. Read the description in this Owner's Manual for details on correct operations.

- Playback from a desired track and random playback are not available during program playback.

# HANDLING PRECAUTIONS

## SERVICING

Should your DVD player become inoperative, do not try to correct the problem by yourself. There are no user-serviceable parts inside. Turn off, unplug the power cord, and please call our help line at 1-800-287-4871, to locate an Authorized Service Center.

## CABINET CLEANING

- Wipe the front panel and other exterior surfaces of the DVD player with a soft cloth immersed in lukewarm water and wrung dry.
- Never use a solvent or alcohol. Do not spray insecticide liquid near the DVD player. Such chemicals may cause damage and discoloration to the exposed surfaces.

## IF THE LASER OPTICAL PICKUP UNIT IS DIRTY

- If the player still does not perform properly when it is operated while referring to the relevant sections and to “TROUBLESHOOTING GUIDE” in this Owner’s Manual, the laser optical pickup unit may be dirty. Consult your dealer or an Authorized Service Center for inspection and cleaning of the laser optical pickup unit.

## DISC HANDLING

- Use discs which have the following logos on them. (Optical audio digital discs.)



- Handle the discs so that fingerprints and dust do not adhere to the surfaces of the discs.

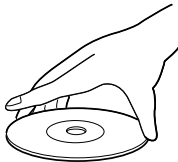
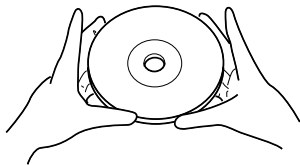

- Always store the disc in its protective case when it is not used.

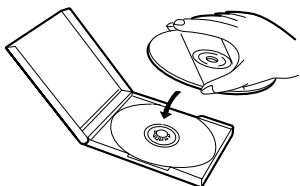

- To clean-off, use a soft cloth.
- Do not use a hard cloth since this will mar the disc.
- Wipe the disc in a straight line from center to edge.
- Never wipe with a circular motion.

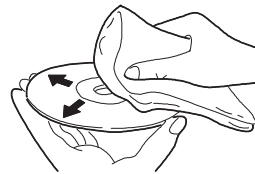

- Do not use detergent or abrasive cleaning agents.

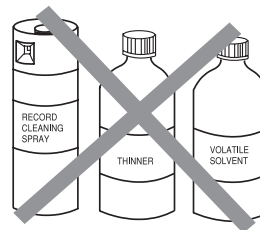

# SPECIFICATIONS

---

Product type :	DVD Player
Discs :	DVD video Audio CD
Output signal format :	NTSC color
Frequency response	
DVD (linear sound) :	20 Hz to 22 kHz (sample rate: 48 kHz) 20 Hz to 44 kHz (sample rate: 96 kHz)
CD :	20 Hz to 20 kHz
Signal-to-noise ratio (S/N ratio)	
CD :	110 dB (EIAJ)
Dynamic range	
DVD (linear sound) :	95 dB
CD :	94 dB (EIAJ)
Total distortion factor	
CD :	0.005% (EIAJ)
Wow and flutter :	Below the measurement limitation (+/-0.001% W PEAK) (EIAJ)
Connections	
S-Video output :	Mini DIN 4-pin jack (75 ohm)
Video output :	One RCA connector, 1 V <sub>pp</sub> (75 ohm)
Coaxial digital audio output :	One pin jack, 500mV <sub>pp</sub> (75 ohm)
Analog audio output :	Two RCA connectors (one left channel, one right channel) 2 V <sub>rms</sub> (47 kilo-ohm)
Component video output :	One pin jack (Y), 1 V <sub>pp</sub> (75 ohm) Two pin jacks (CB)/(CR), 700mV <sub>pp</sub> (75 ohm)
Power source :	120 V AC +/- 10%, 60 Hz +/- 0.5%
Power consumption :	14 W (standby: 2.2W)
Operating temperature :	5°C to 40°C
Dimensions :	W 17-1/8" (435mm) H 3" (75mm) D 8-5/16" (211mm)
Weight :	4.63 lbs (2.1kg)

- Designs and specifications are subject to change without notice.
- If there is a discrepancy between languages, the default language will be English.

## SYLVANIA HOME ENTERTAINMENT WARRANTY

We appreciate your purchase of a SYLVANIA Home Entertainment product. We take pride in the quality of our products and have manufactured your new Home Entertainment unit to exacting quality standards. We feel confident that in normal use, it will provide you with satisfactory performance. However, should you experience difficulty, you are protected under the provisions of this warranty.

SYLVANIA Home Entertainment products are warranted against manufacturing defects in materials and workmanship in normal use for the following period from the date of purchase by the original user, and is conditional upon the unit being installed and used as directed in the instruction manual.

Product	Parts and Labour
D.V.D. Players	1 year
Remote Control	90 days

SYLVANIA's obligation under this warranty shall be limited to the repair, including all necessary parts and the cost of the labour connected therewith, or at our option the exchange of any Home Entertainment product which shows evidence of a manufacturing defect within the warranty period.

Replacement parts, furnished in connection with this warranty shall be warranted for a period equal to the unexpired portion of the original equipment warranty.

### CUSTOMER OBLIGATIONS

This warranty applies to the product from the original date of purchase at retail. Therefore, the owner must provide a copy of the original, dated bill of sale. No warranty service will be performed without a bill of sale. Transportation to and from the service depot is the responsibility of the owner.

### WARRANTY EXCLUSIONS

This warranty is extended to SYLVANIA Home Entertainment products purchased and used in Canada. This warranty shall not apply to appearance or accessory items including but not limited to: antenna, cabinet, cabinet parts, knobs, batteries, connecting cables, cassette tapes, compact discs. This warranty shall, in addition, not apply to damages due to handling, transportation, unpacking, set-up, installation, customer adjustments that are covered in the instruction book, repair or replacement of parts supplied by other than the SYLVANIA authorized service depot, any malfunction or failure caused by or resulting from abnormal environmental conditions, improper unauthorized service, improper maintenance, modifications or repair by the consumer, abuse, misuse, neglect, accident, fire, flood, or other Acts of God, and incorrect line voltage.

This Home Entertainment product is only warranted to the original retail purchaser. This warranty becomes void in the event of commercial or rental use. This warranty becomes void in the event serial numbers are altered, defaced or removed.

SYLVANIA reserves the right to make changes in design or to make additions to or improvements upon this product without incurring any obligation to install the same on products previously manufactured. The foregoing is in lieu of all other warranties expressed or implied and SYLVANIA neither assumes nor authorizes any person to assume for it any other obligation or liability in connection with the sale or service of this product. In no event shall SYLVANIA or its SYLVANIA dealers be liable for special or consequential damage arising from the use of this product, or for any delay in the performance of this warranty due to cause beyond our control.

The purchaser may have other rights under existing provincial or federal laws, and where any terms of this warranty are prohibited by such laws, they are deemed null and void, but the remainder of the warranty shall remain in effect.

### HOW TO OBTAIN SERVICE

Should this product require service, you may obtain specific information on how to obtain service by contacting the SYLVANIA Dealer from whom this product was purchased, or by contacting us directly:

#### **SYLVANIA SERVICE**

300 Alden Road  
Markham, Ontario  
L3R 4C1

PHONE: (905) 940-5089 FAX: (905) 940-2303  
1-800-287-4871



## Free Manuals Download Website

<http://myh66.com>

<http://usermanuals.us>

<http://www.somanuals.com>

<http://www.4manuals.cc>

<http://www.manual-lib.com>

<http://www.404manual.com>

<http://www.luxmanual.com>

<http://aubethermostatmanual.com>

Golf course search by state

<http://golfingnear.com>

Email search by domain

<http://emailbydomain.com>

Auto manuals search

<http://auto.somanuals.com>

TV manuals search

<http://tv.somanuals.com>