

SYLVANIA

SDVD8791



USER'S MANUAL



Table Of Contents

Safety Precaution	1
Introduction	2
Package	2
Main Unit Controls	3
The Remote Control	4
System Connection	7
Basic operation	10
Unit A System Setup	14
Unit B System Setup	17
Specification	20
Troubleshooting	21

Safety Precaution

Thank you for choosing our portable DVD player. It includes a 7" wide screen and a DVD player. The unit applies the latest state of art electronics and is designed for use at home, in hotels and in offices etc for relaxation. The compact size makes carrying easier as well as installation. Please read the manual carefully prior to use and keep it well for later consultation.



Warning: To reduce the risk of fire or electric shock, do not expose this apparatus to rain or moisture.

- 1) Please read the instruction manual carefully and follow all the requirements of safe operation to operate the device.
- 2) Do not use this unit near water. Do not place over the unit any container with liquid inside.
- 3) Do not install near any heat sources such as radiators, heat registers, stoves, or other apparatus (including amplifiers) that produce heat.
- 4) Unplug this unit during lightning storms or when unused for long time.
- 5) About Cleaning: Unplug the system, use only wet cloth to clean. Do not use liquid detergent or aerosol.
- 6) Only use accessories specified by the manufacturer.
- 7) Refer all servicing to qualified service personnel, servicing is required when the unit has been damaged in any way, such as power supply cord or plug is damaged, liquid has been spilled or objects have fallen into the unit, exposed to moisture, does not operate normally. Don't try to repair the machine by yourself because of the danger of high voltage and electric shock.
- 8) Do not use irregular shaped discs such as heart or star-shaped discs as they may cause the unit to malfunction.

Introduction

Your portable DVD player plays digital video discs that conform to the universal DVDVideo standard. With it, you can play movies with true cinema picture quality and stereo or multi-channel sound (depending on disc and play back set-up). You can also select sound track, subtitle languages, and different angle of view (again depending on DVD disc). Besides, you can restrict the play of discs that are not suitable for children.

You can play the following discs on the DVD player (including CD-R,

CD-RW, DVD±R and DVD±RW)

- DVD-Video
- Video CD
- Audio CD
- MP3 CD
- Discs with JPEG files

Package

7 " DVD Players	2
Remote Control with battery	2
AV Cable(DVD to DVD)	1
AC/DC Power Adapter	2
Cigarette Lighter Adapter	1
User Manual	1
Earphone	2
AV Cable (DVD to TV)	1

Unit A Control

Overview of A Unit

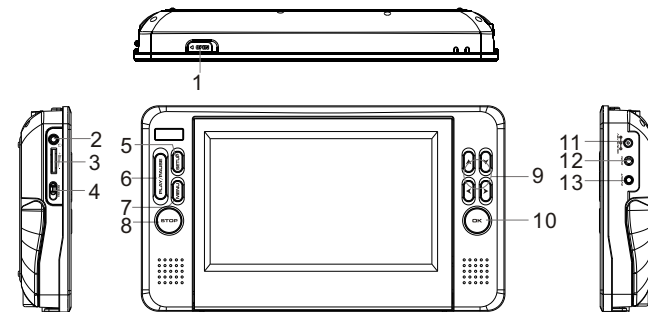

1. Open knob
2. Earphone jack
3. Volume knob
4. Power ON/OFF switch
5. SETUP button
6. Play/Pause
7. MENU button

8. STOP button
9. ▲▼◀▶
10. OK button
11. DCIN 9-12V
12. AV IN
13. AV OUT

Overview of B Unit

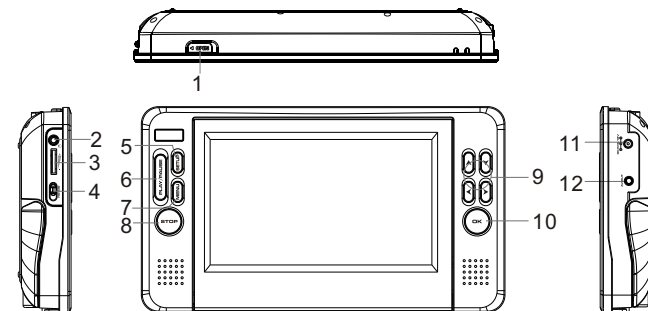

1. Open knob
2. Earphone jack
3. Volume knob
4. Power ON/OFF switch
5. SETUP button
6. Play/Pause

7. MENU button
8. STOP button
9. ▲▼◀▶
10. OK button
11. DCIN 9-12V
12. AV OUT

The Remote Control

Remote control for A unit

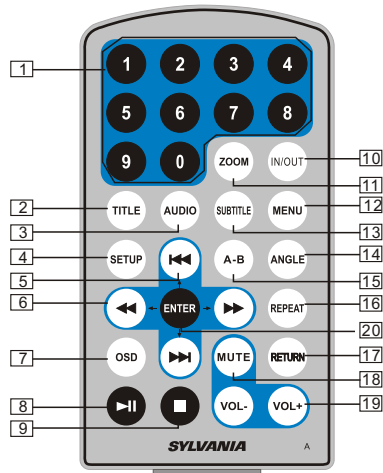

- | | |
|--|--|
| 1. Number button | 11. Zoom (To zoom in or zoom out the scene when playing) |
| 2. TITLE (To display title information) | 12. Menu (To enter or exit menu page) |
| 3. AUDIO (To select audio language) | 13. Subtitle (To select subtitle language when playing DVD disc) |
| 4. SETUP (To go to or exit setup menu) | 14. Angle (To change viewing angle when playing disc with multi-angle) |
| 5. Previous/Next button (To go to previous/next chapter or scene during playing) | 15. A-B (Repeat a specific portion from point A to B, press it again to cancel repeat playing) |
| 6. Fast forward/backward button (To scan forward/backward at 2, 4, 8, 16, or 32 times) | 16. Repeat (To repeat playing title, chapter or track) |
| 7. OSD (To display disc information during playing) | 17. Return (To return to the main menu) |
| 8. Play/Pause | 18. Mute (To turn mute) |
| 9. Stop (First time: Stop at the present playing point; Press ► to continue to play; press it again to stop playing) | 19. VOL +/- (To adjust the volume) |
| 10. IN/OUT (To input or output signal) | 20. Enter (To confirm) |

Remote control for B unit

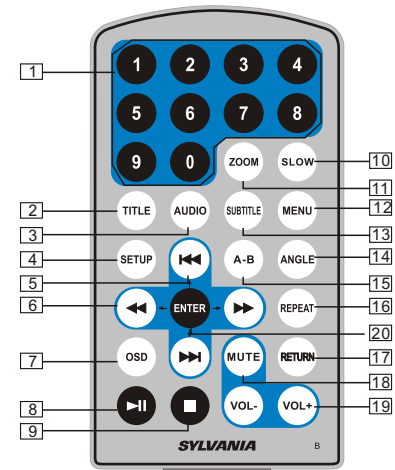

- | | |
|---|--|
| 1. Number button | 10. SLOW |
| 2. TITLE (To display title information) | 11. ZOOM (To zoom in/out the image during playback) |
| 3. AUDIO (To select audio language) | 12. MENU (To enter or exit menu root) |
| 4. SETUP (To go to or exit setup menu) | 13. SUBTITLE (To select subtitle language when playing DVD disc) |
| 5. ◀▶ button (To go to Previous/next chapter or scene during playing) | 14. ANGLE (To change viewing angle when playing disc with multi-angle) |
| 6. ◀▶ button (To scan forward /backward at 2, 4, 8, 16 or 32 times) | 15. A-B (Repeat a specific portion from point A to B, press it again to cancel repeat playing) |
| 7. OSD (To display disc information during playing such as elapsed and remaining) | 16. REPEAT (To Repeat playing title, chapter or track) |
| 8. Play/pause | 17. RETURN (To return to the main menu) |
| 9. STOP (press once to stop playback, then press ► to resume playback from the point where you stopped; press stop button twice to stop playback completely). | 18. MUTE (To turn mute) |
| | 19. VOL +/- (To adjust the volume) |
| | 20. ENTER (To confirm) |

The Use of Remote Control

Please put the battery into the remote control as per below illustration

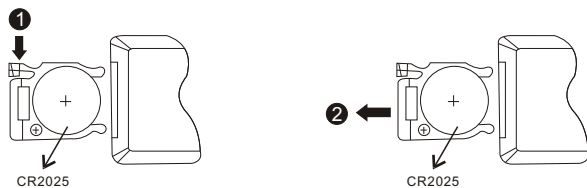

When using remote control, make sure the infrared window is pointed to infrared receiving window of the machine. The distance between machine and remote control must be within 3 metres. Please refer to the following illustration.

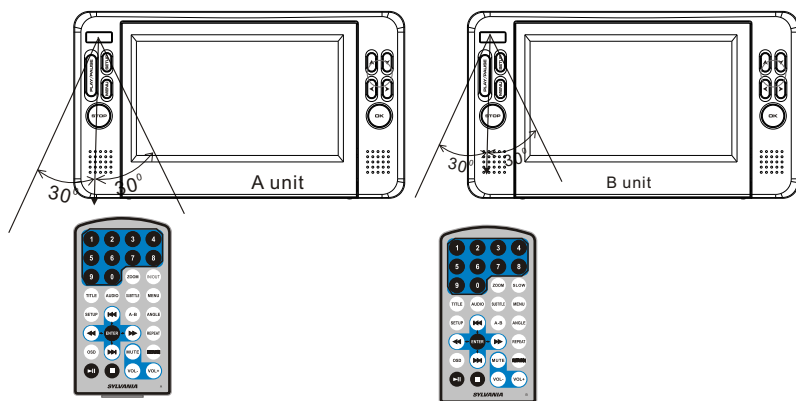

Notice

1. To avoid falling off or place near damp environment.
2. To avoid infrared receiving window of the unit being under direct sunlight
3. Please use a new battery to replace old one if the remote control doesn't work.

System Connection

Connect A unit

Caution: turn off your player before you connect A unit

1. Connect the supplied AV cable to:

- the AV out jack on B unit.
- the AV IN jack on A unit.

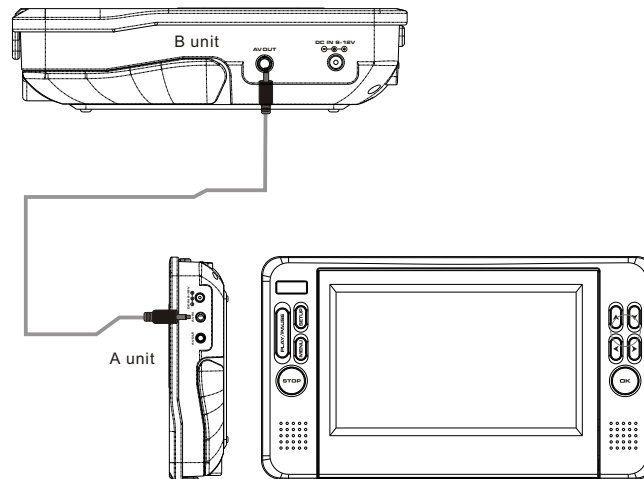

Connect power

Caution:

1. Risk of product damage! Ensure that the power supply voltage corresponds to the voltage pointed on the back or the underside of the player.
2. Risk of electric shock ! When you unplug the AC adapter, always pull the plug from the socket. Never pull the cable.
3. connect one end of the double-connector end of the AC cable to the DC IN jack on A unit.
4. connect the other end of the double-connector end of the AC cable to the DC IN jack on B unit.
5. connect the one-connector end to the car cigarette lighter socket.

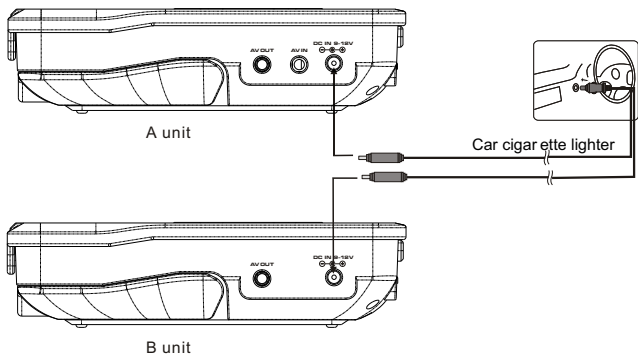

Connecting DC Adaptor

1. Connect the AC adapter cable to:
 - the DC IN jack on the A unit or B unit .
 - The power outlet

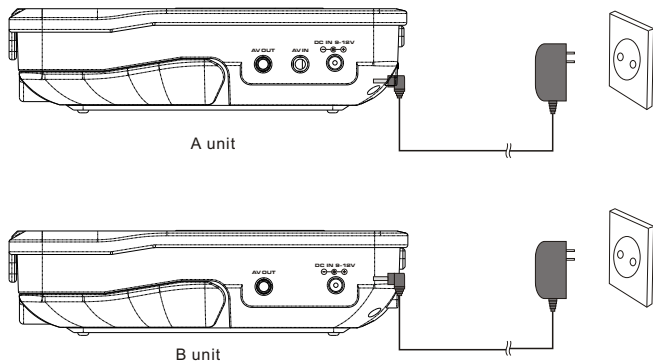

Connect additional equipment

Caution: turn off your player before connecting to any additional equipment. You can connect the player to a TV or an amplifier to enjoy DV Ds or Karaoke. Match the color of the AV cables with the jacks: the yellow cable is for the yellow video jack, the red/white cable is for the red/white audio jacks.

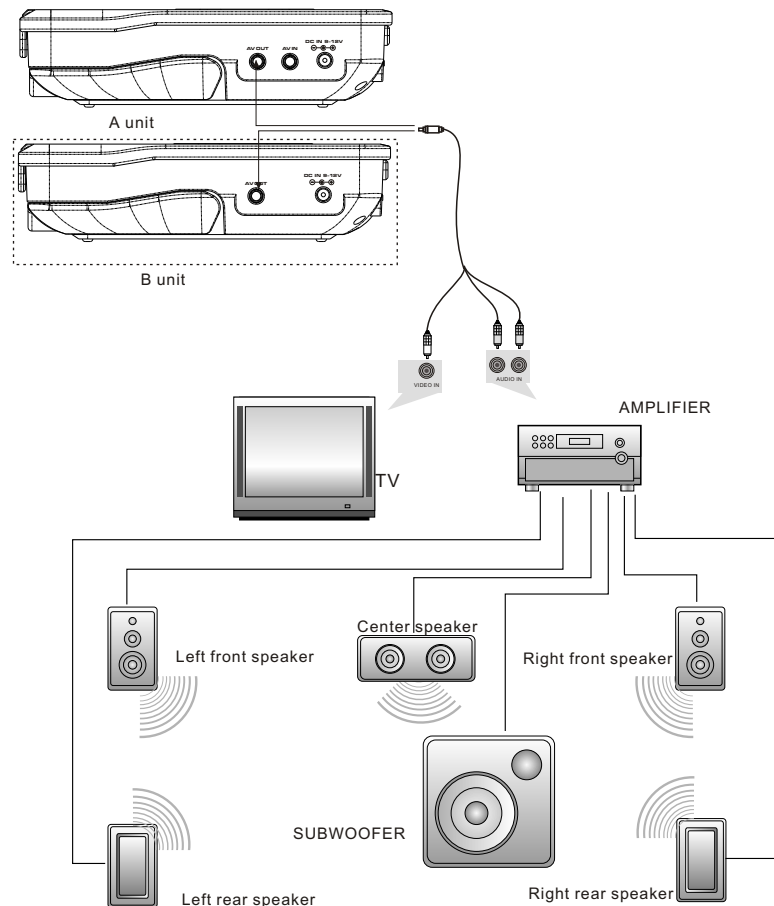

Notice: There is no 5.1 channel in the unit, however, after connecting to APM it is available to output audio in 5.1 channel

Basic Operation



Playing disc of DVD, MPEG4, SVCD, VCD, CD, Mp3

1. After connecting power to the unit, turn on the unit with the ON/OFF switch.
2. Open the disc tray and place a disc into the tray with the label side facing up.
3. Close the tray. The unit will load the disc and start playing.
4. Press ■ to stop playing at the present point; Press ►|| To continue to play; press ■ again to stop playing).
6. During playback press ►|| to pause; press it again to continue to play.
6. When the playing is finished, please turn off the power.
7. For some DVD disc with Title or Chapter menu, press " MENU" button to enter menu page, select programme by number buttons or ◀▶ or ▶▶▶▶ .

Notice: When at pause, stop, or no disc, in about 3 minutes the unit will be protected. Press any button to exit.

Pause during playback



During playback, press [►||] to pause; press it again to resume playback

Note

When at PAUSE, STOP, or no disc, in about 3 minutes the unit will be protected; press any button to exit.

Play DVD disc with title or chapter menu

For some DVD disc with Title or chapter menu, press MENU button to enter menu page, and use direction button to select, Press " ENTER" to confirm.

Fast forward and fast backward



When playing disc of DVD, MPEG4, SVCD, VCD, CD, the unit can search forward or backward.

1. Press ►►, the unit will search forward. Press it repeatedly, the unit will play at 2, 4, 8, 16, 32 times of speed.

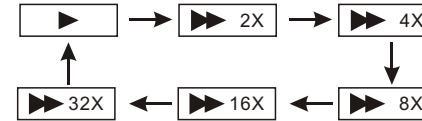

2. Press ◀◀, the unit will search backward. Press it repeatedly, the unit will play at 2, 4, 8, 16, 32 times of speed.

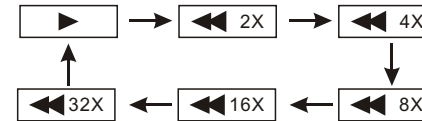

Repeat playing



When playing disc of DVD, MPEG4, SVCD, VCD, CD, user can repeat playing one chapter, title or the whole disc.

For DVD disc, press repeat button to repeat playing one Chapter, press it again to repeat playing Title; press it third time to repeat playing the whole disc; Press it again to cancel repeat function.

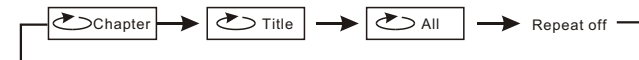

For CD/VCD disc, press Repeat repeatedly to repeat the track and the whole disc



For Mp3 disc, press REPEAT to repeat playing current file; press it again to repeat playing the folder; press it third time to cancel repeat function.



Repeat playing of favorite scene



When playing disc of DVD, MPEG4, SVCD, VCD, CD, Mp3, user can repeatedly play a specific section.

During playback, press "A-B" button at a point A, then press this button again in point B, the unit will automatically repeat playing the part between A-B



Press it the third time, the unit will return to normal playback.



Angle

During playing DVD disc with multi-angle, press "Angle" button, the followings will be displayed on screen:



Press number buttons to select the angle you desire



To return to normal playing, please press "Angle". The unit will play the disc in the default angle.



Notice

The function is available only for discs with multi-angle.

Zoom in/ out



When playing disc of DVD, MPEG4, SVCD, VCD, user can zoom in or zoom out the image.

During playback, press "Zoom" button, the image will be enlarged; press it again the image will be enlarged again; press it fourth time, the image will zoom out, press it repeatedly and the image will return to normal status.

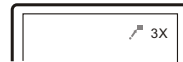

When the image is enlarged, user can press ◀▶ to move the image

Playing JPG file

1. Place a JPG disc into the tray, the unit will start reading and play.
2. Press "MENU" to browse JPG file.
3. When viewing JPG file, press [■], pictures will be displayed in thumbnail mode, press [▲▼◀▶] or OK button to select one picture to view.
4. Press [▲▼] and OK button to select a JPG file from the menu.
5. To browse JPG file selected, press [▶] or OK button.
6. To rotate the picture counter-clockwise, press [◀]; Press [▶] to rotate the picture clockwise.
7. Press [▼] to reverse the picture horizontally and press [▲] to reverse the picture vertically.
8. Press OSD button when viewing pictures, you can select different refresh mode as follows:
 - ①. from top to bottom
 - ②. from bottom to top
 - ③. from left side to right side
 - ④. from right side to left side
 - ⑤. from left top to right bottom
 - ⑥. from right top to left bottom
 - ⑦. from left bottom to right top
 - ⑧. from right bottom to left top
 - ⑨. from horizontal centre to both sides
 - ⑩. from vertical centre to both sides
 - ⑪. from top and bottom to centre
 - ⑫. from right and left to centre
 - ⑬. from four window top side to bottom side
 - ⑭. from four window left side to right side
 - ⑮. from four edges to centre
9. During viewing files, "O" may appear when pressing "Angle" or "Subtitle" or "Audio" or "A-B" or "Title" etc; in this situation these options are unavailable to operate.

Play Mp3 file

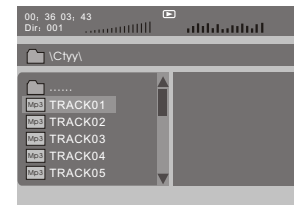

1. Place Mp3 disc into the disc door.
2. Press [▲▼] or OK button to select a Mp3 file; Press [▶] or OK button to play the file selected.

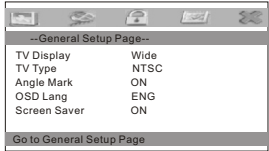

Unit A System Setup

	<p>Press "Setup" button, the main menu will be displayed on the screen</p> <p>In the General Setup Page, Press ◀▶ button to highlight this item.</p> <p>Press OK button to access.</p> <p>Press ▲▼ button to select the setting.</p> <p>Press OK button to confirm your selection.</p> <p>Press ◀ button to exit.</p>
---	---

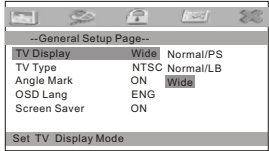
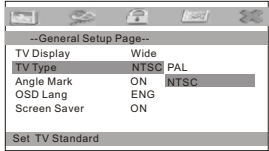
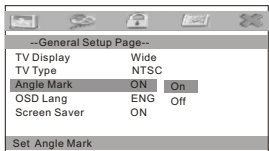
General setup page

	<p>TV display:</p> <p>Enter this option, user can set screen display format (Normal/PS, Normal/LB, Wide)</p> <p>The default is "Wide"</p> <p>Note:</p> <ul style="list-style-type: none"> ☆ The function depends on the display ratio with which the DVD disc is recorded. ☆ Please choose "Wide(16:9)" when using a 16:9 widescreen TV set 16:9
	<p>TV Type:</p> <p>Enter this option to select TV type (PAL, NTSC)</p> <p>The default is NTSC.</p>
	<p>Angle Mark:</p> <p>When available, a camera symbol will appear on the screen when various angle are available on the DVD. Select "OFF" and the camera symbol will disappear</p>
	<p>OSD Language:</p> <p>In the option user can set OSD menu language (English, French, German, Italian).</p> <p>The default: English</p>

Video Setup Page

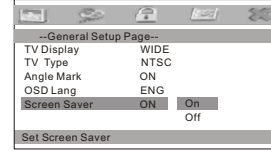
	<p>Screen Saver:</p> <p>Select On to activate the screen saver function, when you activate this function, a moving DVD symbol appears on the screen when the unit is stopped or when it shows a still picture for several minutes. This feature saves the screen from being damaged by a static image remaining on the LCD screen for long periods of time.</p> <p>Select Off to cancel this function.</p>
---	---

Video setup page

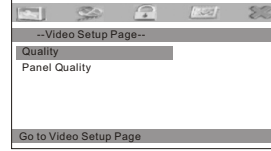
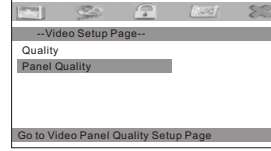
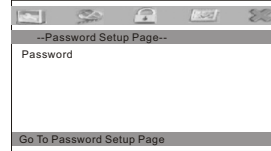
	<p>Enter this option, user can adjust picture quality of video output. There are items available to be adjusted: Brightness, contrast, Hue and Saturation.</p> <p>For all these items the default is 00</p>
	<p>Enter this option, user can adjust picture quality of unit screen. There are items available to be adjusted: Brightness, contrast, Hue and Saturation.</p> <p>For all these items the default is 00</p>
	<p>Enter this option, you can set a password (four numbers). All parental Control features are password protected. This function allows you to change the password. The default password is 8888.</p>

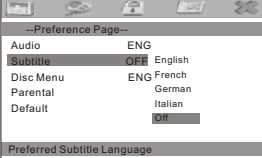
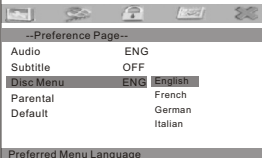
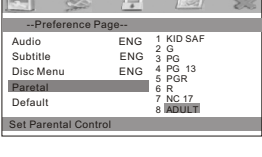
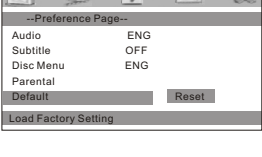

Preference page

 <p>--Preference Page--</p> <p>Audio ENG English</p> <p>Subtitle OFF French</p> <p>Disc Menu ENG German</p> <p>Parental German Italian</p> <p>Default</p> <p>Preference Audio Language</p>	<p>Audio: Enter this option, user can select your preferred audio language for DVDs, The default is English.</p> <p>Note: ☆ The audio language depends on the material on each disc. ☆ User can also change the audio language during playback by pressing the Audio button.</p>
 <p>--Preference Page--</p> <p>Audio ENG</p> <p>Subtitle OFF English</p> <p>Disc Menu ENG French German</p> <p>Parental German Italian</p> <p>Default</p> <p>Preferred Subtitle Language</p>	<p>Subtitle: Select your preferred language to show the subtitles on the screen. The subtitle languages depend on the information available on each disc, You can also change the subtitle language during playback by pressing the SUBTITLE button.</p>
 <p>--Preference Page--</p> <p>Audio ENG</p> <p>Subtitle OFF</p> <p>Disc Menu ENG English</p> <p>Parental French</p> <p>Default German Italian</p> <p>Preferred Menu Language</p>	<p>Disc Menu: This function allows you to choose the menu language stored on the disc.</p>
 <p>--Preference Page--</p> <p>Audio ENG 1 KID SAF</p> <p>Subtitle ENG 2 G</p> <p>Disc Menu ENG 3 PG</p> <p>Parental 4 PG 13</p> <p>Default 5 PGR</p> <p>7 NC 17</p> <p>8 ADULT</p> <p>Set Parental Control</p>	<p>Parental: DVD discs equipped with the child lock function are rated according to their content. The content authorized by a parental lock level and the way a disc can be controlled may vary from disc to disc. If the disc allows, you can edit out violent scenes and replace them or lock out playback of the disc altogether. press the number button on the remote control to enter the password and press the OK button to return to the previous menu. The default is ADULT.</p>
 <p>--Preference Page--</p> <p>Audio ENG</p> <p>Subtitle OFF</p> <p>Disc Menu ENG</p> <p>Parental</p> <p>Default Reset</p> <p>Load Factory Setting</p>	<p>Default: Select this item and press OK button to reset all settings to the original factory settings.</p>

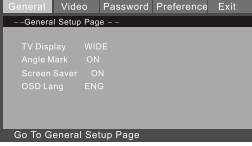
Unit B System Setup

 <p>General Video Password Preference Exit</p> <p>--General Setup Page--</p> <p>TV Display WIDE</p> <p>Angle Mark ON</p> <p>Screen Saver ON</p> <p>OSD Lang ENG</p> <p>Go To General Setup Page</p>	<p>Press "Setup" button, the main menu will be displayed on the screen In the General Setup Page, Press ◀ button to highlight this item. Press OK button to access. Press ▲▼ button to select the setting. Press OK button to confirm your selection. Press ▶ button to exit.</p>
--	---

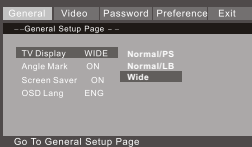
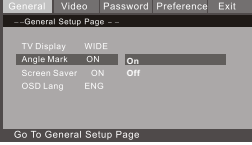
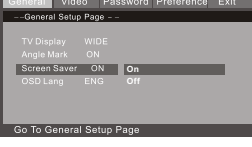
General Setup Page

 <p>General Video Password Preference Exit</p> <p>--General Setup Page--</p> <p>TV Display WIDE Normal/PS</p> <p>Angle Mark ON Normal/LB</p> <p>Screen Saver ON Wide</p> <p>OSD Lang ENG</p> <p>Go To General Setup Page</p>	<p>TV display: Enter this option, user can set screen display format (Normal/PS, Normal/LB, Wide) The default is "Wide" Note: ☆ The function depends on the display ratio with which the DVD disc is recorded. ☆ Please choose "Wide(16:9)" when using a 16:9 widescreen TV set</p>
 <p>General Video Password Preference Exit</p> <p>--General Setup Page--</p> <p>TV Display WIDE</p> <p>Angle Mark ON On</p> <p>Screen Saver ON Off</p> <p>OSD Lang ENG</p> <p>Go To General Setup Page</p>	<p>Angle Mark: Enter this option to set the angle during playback. Optional setting: ON, OFF The default is: ON</p>
 <p>General Video Password Preference Exit</p> <p>--General Setup Page--</p> <p>TV Display WIDE</p> <p>Angle Mark ON</p> <p>Screen Saver ON On</p> <p>OSD Lang ENG Off</p> <p>Go To General Setup Page</p>	<p>Screen Saver: Enter this option to set whether to activate the screen saver function. The default is ON.</p>
 <p>General Video Password Preference Exit</p> <p>--General Setup Page--</p> <p>TV Display WIDE</p> <p>Angle Mark ON</p> <p>Screen Saver ON</p> <p>OSD Lang ENG English</p> <p>French German Italian</p> <p>Go To General Setup Page</p>	<p>OSD Language: In the option user can set OSD menu language (English, French, German, Italian). The default: English</p>

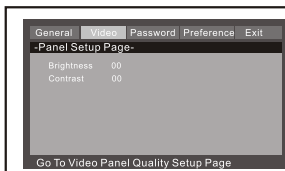

Enter this option, user can adjust picture quality of video output. There are items available to be adjusted: Brightness, contrast, Hue and Saturation. For all these items the default is 00

Password Setup Page



Enter this option, you can set a password (four numbers). All parental control features are password protected.

The default is 8888.

Preference Page

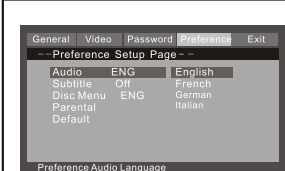

Audio:

Enter this option, user can select your preferred audio language for DVDs.

The default is English.

Note:

- ☆ The audio language depends on the material on each disc.
- ☆ User can also change the audio language during playback by pressing the Audio button.

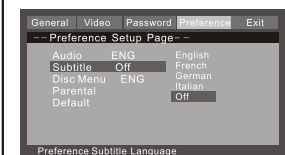

Subtitle:

Select your preferred language to show the subtitles on the screen.

The default is OFF

The subtitle languages depend on the information available on each disc. You can also change the subtitle language during playback by pressing the SUBTITLE button.



Disc Menu:

This function allows you to choose the menu language stored on the disc.

The default is English.

Note: the disc menu languages depend on the information available on the disc.

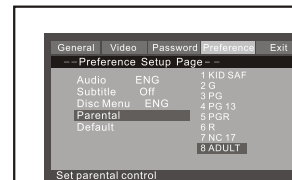

Parental:

Enter this option to set the parental control level to some unsuitable disc scenes being watched by the children. Optional parental control levels: KID SAFE, G, PG, PG 13, PGR, R, NC17, ADULT.

The default of this option is ADULT.

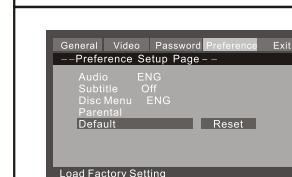

Default:

Select this item and press OK button to reset all settings to the original factory settings.

Specification

Compatible disc: DVD/VCD/CD/Mp3/MPEG4

Signal system: PAL/NTSC

Panel size: 7 inch

Frequency response: 20 Hz to 20 kHz

Video output: 1 Vp-p/75 Ohm, unbalanced

Audio output: 1.4Vrms/10kOhm

Audio S/N: Better than 80 dB

Dynamic range: Better than 85 dB

Laser: Semiconductor Laser, Wave Length: 650 nm/795 nm

Power source: DC 9-12V

Power consumption: 10 W

Operating temperature: 0~40°C

Weight(A unit/B unit): 0.7/0.7kg

Dimensions (A unit/B unit)(W x D x H): 255x 146x 36/255x 146x 36mm

Note:

1. The quality and speed for reading JPEG photos depend on the resolution and compression ratio of the photos. Some JPEG photo may not be played due to the disc quality and the formats.
2. Some DVD+R/RW, DVD-R/RW, CD-R/RW disc may not be played due to the quality on burning conditions.

Rechargeable battery use

The unit utilizes long-life Li polymer battery for portable power supply. The battery has no Memory Effect and thus can be recharged safely regardless of whether the battery is fully or partially discharged. It is enough to recharge no longer than 6H each time. fully recharged battery can last about 2 hours.

Precautions related to Battery Recharge

The battery can be only recharged when turning power to OFF state, and keep continuous power supply, the red light will be on, and the light will turn yellow when it is fully charged.

Using and Maintaining Rechargeable Battery

1. The normal working temperature is: 0°C ~40°C ;
2. Always unplug AC/DC power supply for the unit when not in use;
3. Heat will create during playing, it's normal, while avoid long time playing and unattended;
4. Avoid having the unit collide with any objects, and place away from all possible heat sources or damp areas.

Troubleshooting

PROBLEM	SOLUTION
No sound or distorted sound	Make sure the machine is connected properly. Make sure all cables are securely inserted into the appropriate jacks.
Can't advance through a movie	You can't advance through the opening credits and warning information that appears at the beginning of movies because the disc is programmed to prohibit that action.
The icon  appears on screen	The feature or action cannot be completed at this time because: <ol style="list-style-type: none"> 1. The disc's software restricts it. 2. The disc's software doesn't support the feature (e.g., angles) 3. The feature is not available at the moment. 4. You've requested a title or chapter number that is out of range.
Picture is distorted	The disc might be damaged. Try another disc; It is normal for some distortion to appear during forward or reverse scan.
No forward or reverse scan	Some discs have sections that prohibit rapid scanning or chapterskip; If you try to skip through the warning information and credits at the beginning of a movie, you won't be able to. This part of the movie is often programmed to prohibit skipping through it.



If at any time in the future you should need to dispose of this product please note that waste electrical products should not be disposed of with household waste. Please recycle where facilities exist. Check with your Local Authority or retailer for recycling advice. (Waste Electrical and Electronic equipment Directive)

Owing to continuous improvement, no prior notice will be given regarding changes on above feature and spec.

Free Manuals Download Website

<http://myh66.com>

<http://usermanuals.us>

<http://www.somanuals.com>

<http://www.4manuals.cc>

<http://www.manual-lib.com>

<http://www.404manual.com>

<http://www.luxmanual.com>

<http://aubethermostatmanual.com>

Golf course search by state

<http://golfingnear.com>

Email search by domain

<http://emailbydomain.com>

Auto manuals search

<http://auto.somanuals.com>

TV manuals search

<http://tv.somanuals.com>