

OWNER'S MANUAL

SYLVANIA

DVD PLAYER SRDV100

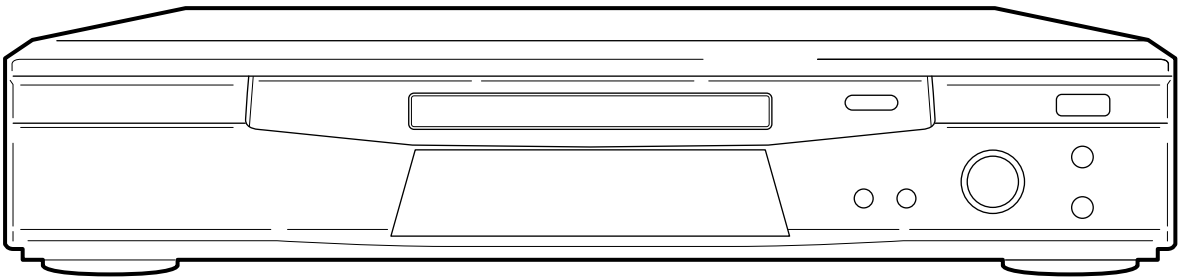

INSTRUCCIONES EN ESPAÑOL INCLUIDAS.

If you need additional assistance for set-up or operating
after reading owner's manual, please call
TOLL FREE : 1-800-968-3429

WARNING:

TO REDUCE THE RISK OF FIRE OR ELECTRIC SHOCK, DO NOT EXPOSE THIS APPLIANCE TO RAIN OR MOISTURE.

**CAUTION**

**RISK OF ELECTRIC SHOCK
DO NOT OPEN**

**CAUTION:**

TO REDUCE THE RISK OF ELECTRIC SHOCK, DO NOT REMOVE COVER (OR BACK). NO USER SERVICEABLE PARTS INSIDE. REFER SERVICING TO QUALIFIED SERVICE PERSONNEL.



The lightning flash with arrowhead symbol, within an equilateral triangle, is intended to alert the user to the presence of uninsulated "dangerous voltage" within the product's enclosure that may be of sufficient magnitude to constitute a risk of electric shock to persons.



The exclamation point within an equilateral triangle is intended to alert the user to the presence of important operating and maintenance (servicing) instructions in the literature accompanying the appliance.

LASER SAFETY

This unit employs a laser. Only a qualified service person should remove the cover or attempt to service this device, due to possible eye injury.

CAUTION: USE OF CONTROLS OR ADJUSTMENTS OR PERFORMANCE OF PROCEDURES OTHER THAN THOSE SPECIFIED HEREIN MAY RESULT IN HAZARDOUS RADIATION EXPOSURE.

CAUTION: VISIBLE AND INVISIBLE LASER RADIATION WHEN OPEN AND INTERLOCK DEFEATED. DO NOT STARE INTO BEAM.

LOCATION: INSIDE, NEAR THE DECK MECHANISM.

FCC WARNING- This equipment may generate or use radio frequency energy. Changes or modifications to this equipment may cause harmful interference unless the modifications are expressly approved in the instruction manual. The user could lose the authority to operate this equipment if an unauthorized change or modification is made.

RADIO-TV INTERFERENCE

This equipment has been tested and found to comply with the limits for a Class B digital device, pursuant to Part 15 of the FCC Rules. These limits are designed to provide reasonable protection against harmful interference in a residential installation. This equipment generates, uses, and can radiate radio frequency energy and, if not installed and used in accordance with the instructions, may cause harmful interference to radio communications. However, there is no guarantee that interference will not occur in a particular installation. If this equipment does cause harmful interference to radio or television reception, which can be determined by turning the equipment off and on, the user is encouraged to try to correct the interference by one or more of the following measures:

- 1) Reorient or relocate the receiving antenna.
- 2) Increase the separation between the equipment and receiver.
- 3) Connect the equipment into an outlet on a circuit different from that to which the receiver is connected.
- 4) Consult the dealer or an experienced radio/TV technician for help.

This Class B digital apparatus complies with Canadian ICES-003.

Cet appareil numérique de la classe B est conforme à la norme NMB-003 du Canada.

CAUTION: TO PREVENT ELECTRIC SHOCK, MATCH WIDE BLADE OF PLUG TO WIDE SLOT, FULLY INSERT.

ATTENTION: POUR ÉVITER LES CHOC ÉLECTRIQUES, INTRODUIRE LA LAME LA PLUS LARGE DE LA FICHE DANS LA BORNE CORRESPONDANTE DE LA PRISE ET POUSSER JUSQU'AU FOND.

IMPORTANT SAFEGUARDS

- 1) Read Instructions - All the safety and operating instructions should be read before the product is operated.
- 2) Retain Instructions - The safety and operating instructions should be retained for future reference.
- 3) Heed Warnings - All warnings on the product and in the operating instructions should be adhered to.
- 4) Follow Instructions - All operating and use instructions should be followed.
- 5) Cleaning - Unplug this product from the wall outlet before cleaning. Do not use liquid cleaners or aerosol cleaners. Use a damp cloth for cleaning.
- 6) Attachments - Do not use attachments not recommended by the product manufacturer as they may cause hazards.
- 7) Water and Moisture - Do not use this product near water - for example, near a bath tub, wash bowl, kitchen sink, or laundry tub; in a wet basement; or near a swimming pool; and the like.
- 8) Accessories - Do not place this product on an unstable cart, stand, tripod, bracket, or table. The product may fall, causing serious injury to a child or adult, and serious damage to the product. Use only with a cart, stand, tripod, bracket, or table recommended by the manufacturer, or sold with the product. Any mounting of the product should follow the manufacturer's instructions, and should use a mounting accessory recommended by the manufacturer.
- 9) A product and cart combination should be moved with care. Quick stops, excessive force, and uneven surfaces may cause the product and cart combination to overturn.
- 10) Ventilation - Slots and openings in the cabinet are provided for ventilation and to ensure reliable operation of the product and to protect it from overheating, and these openings must not be blocked or covered. The openings should never be blocked by placing the product on a bed, sofa, rug, or other similar surface. This product should not be placed in a built-in installation such as a bookcase or rack unless proper ventilation is provided or the manufacturer's instructions have been adhered to.
- 11) Power Sources - This product should be operated only from the type of power source indicated on the marking label. If you are not sure of the type of power supply to your home, consult your product dealer or local power company. For products intended to operate from battery power, or other sources, refer to the operating instructions.
- 12) Grounding or Polarization - This product may be equipped with a polarized alternating-current line plug (a plug having one blade wider than the other). This plug will fit into the power outlet only one way. This is a safety feature. If you are unable to insert the plug fully into the outlet, try reversing the plug. If the plug should still fail to fit, contact your electrician to replace your obsolete outlet. Do not defeat the safety purpose of the polarized plug.
- 13) Power-Cord Protection - Power-supply cords should be routed so that they are not likely to be walked on or pinched by items placed upon or against them, paying particular attention to cords at plugs, convenience receptacles, and the point where they exit from the product.
- 14) Lightning - For added protection for this product during a lightning storm, or when it is left unattended and unused for long periods of time, unplug it from the wall outlet and disconnect the antenna or cable system. This will prevent damage to the product due to lightning and power-line surges.
- 15) Power lines - An outside antenna system should not be located in the vicinity of overhead power lines or other electric light or power circuits, or where it can fall into such power lines or circuits. When installing an outside antenna system, extreme care should be taken to keep from touching such power lines or circuits as contact with them might be fatal.
- 16) Overloading - Do not overload wall outlets, extension cords, or integral convenience receptacles as this can result in a risk of fire or electric shock.
- 17) Object and Liquid Entry - Never push objects of any kind into this product through openings as they may touch dangerous voltage points or short-out parts that could result in a fire or electric shock. Never spill liquid of any kind on the product.
- 18) Servicing - Do not attempt to service this product yourself as opening or removing covers may expose you to dangerous voltage or other hazards. Refer all servicing to qualified service personnel.
- 19) Damage Requiring Service - Unplug this product from the wall outlet and refer servicing to qualified service personnel under the following conditions:
 - a) When the power-supply cord or plug is damaged,
 - b) If liquid has been spilled, or objects have fallen into the product,
 - c) If the product has been exposed to rain or water,
 - d) If the product does not operate normally by following the operating instructions. Adjust only those controls that are covered by the operating instructions as an improper adjustment of other controls may result in damage and will often require extensive work by a qualified technician to restore the product to its normal operation,
 - e) If the product has been dropped or damaged in any way, and
 - f) When the product exhibits a distinct change in performance - this indicates a need for service.
- 20) Replacement Parts - When replacement parts are required, be sure the service technician has used replacement parts specified by the manufacturer or have the same characteristics as the original part. Unauthorized substitutions may result in fire, electric shock, or other hazards.
- 21) Safety Check - Upon completion of any service or repairs to this product, ask the service technician to perform safety checks to determine that the product is in proper operating condition.
- 22) Heat - The product should be situated away from heat sources such as radiators, heat registers, stoves, or other products (including amplifiers) that produce heat.

PORTABLE CART WARNING
(Symbol provided by RETAC)



A NOTE ABOUT RECYCLING

This product's packaging materials are recyclable and can be reused. Please dispose of any materials in accordance with your local recycling regulations.

Batteries should never be thrown away or incinerated but disposed of in accordance with your local regulations concerning chemical wastes.

The serial number of this product may be found on the back of the DVD player. No others have the same serial number as yours. You should record the number and other vital information here and retain this book as a permanent record of your purchase to aid identification in case of theft. Serial numbers are not kept on file.

Date of Purchase	
Dealer Purchase from	
Dealer Address	
Dealer Phone No.	
Model No.	
Serial No.	

ABOUT COPYRIGHT

Unauthorized copying, broadcasting, public performance and lending of discs are prohibited.

This product incorporates copyright protection technology that is protected by method claims of certain U.S. patents and other intellectual property rights owned by Macrovision Corporation and other rights owners. Use of this copyright protection technology must be authorized by Macrovision Corporation, and is intended for home and other limited viewing uses only unless otherwise authorized by Macrovision Corporation. Reverse engineering or disassembly is prohibited.

SUPPLIED ACCESSORIES

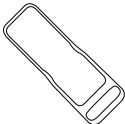
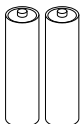
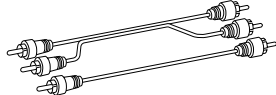
<p>Remote control</p>  <p>(N9150UD)</p>	<p>Two AA batteries</p> 	<p>A/V cables</p>  <p>(approx. 3 feet (100 cm) long) (WPZ0102TM015)</p>
--	---	---

SYMBOLS USED IN THIS MANUAL

The following symbols appear below in some headings and notes in this manual, with the following meanings!

DVD

: Description refers to playback of DVD video discs.

CD

: Description refers to playback of audio CDs.

TABLE OF CONTENTS

■ LASER SAFETY	2
■ IMPORTANT SAFEGUARDS	3
ABOUT COPYRIGHT	4
SUPPLIED ACCESSORIES	4
SYMBOLS USED IN THIS MANUAL	4
■ FEATURES	6
■ ABOUT THE DISCS	7
PLAYABLE DISCS	7
DISC TYPES	7
■ OPERATING CONTROLS AND FUNCTIONS	8
DISPLAY	9
DISPLAYS DURING OPERATION	9
LOADING THE BATTERIES	9
■ HOOKUPS	10
CONNECTING TO A TV	10
CONNECTING TO A STEREO SYSTEM	10
CONNECTING TO AN AMPLIFIER EQUIPPED WITH DIGITAL INPUT JACKS, MD DECK OR DAT DECK	11
CONNECTING TO A TV OR A STEREO TV THAT HAS COMPONENT VIDEO IN JACKS	11
CONNECTING TO A DOLBY DIGITAL DECODER OR DTS DECODER	12
■ PLAYING A DISC	13
PLAYING A DVD VIDEO OR AN AUDIO CD	13
USING THE DVD MENUS	13
USING THE TITLE MENU	14
PAUSING PLAYBACK OR DISPLAYING A STILL PICTURE	14
RESUMING PLAYBACK FROM THE POINT WHERE PLAYBACK STOPPED	14
STEPPING THROUGH FRAMES	14
FAST FORWARD/REVERSE	15
SLOW MOTION	15
STARTING FROM A DESIRED TRACK	15
STARTING FROM A DESIRED TIME COUNT	15
PLAYING FROM A DESIRED TITLE OR CHAPTER	16
RANDOM (Audio CD)	16
REPEAT	16
A-B REPEAT	17
PROGRAM (Audio CD)	17
■ SETTINGS	18
ZOOM PLAYBACK	18
CHANGING THE AUDIO LANGUAGE OR SOUND MODE	18
CHANGING THE SUBTITLE LANGUAGE	19
CHANGING THE CAMERA ANGLE (Multi-Angle Pictures)	19
CHANGING THE ON-SCREEN DISPLAY	20
■ CHANGING THE SETUP ITEMS	21
LANGUAGE SETTINGS	21
DISPLAY SETTINGS	22
AUDIO SETTINGS	23
PARENTAL LOCK	24
■ LANGUAGE CODE LIST	25
■ TROUBLESHOOTING GUIDE	26
■ HANDLING PRECAUTIONS	27
DISC HANDLING	27
■ SPECIFICATIONS	28
■ WARRANTY	BACK COVER

INDICE

■ CONTROLES DE OPERACIÓN Y FUNCIONES	29
■ CONEXIONES	31
■ REPRODUCCIÓN DE UN DISCO	31

FEATURES

- **Dolby Digital sound**

This player can handle Dolby Digital surround sound having 5.1 channels when connected to a Dolby Digital decoder.

- **Still/fast/slow/step playback**

Various playback modes are available including still pictures, fast forward/reverse, slow motion and step frames.

- **Random playback for audio CD**

This player can shuffle the order of tracks to play them in random order.

- **Program playback for audio CD**

You can program the order of tracks to play them in any desired order.

- **DVD menus in a desired language**

You can display DVD menus in a desired language, if available on a DVD.

- **Screen saver/Auto power-off functions**

The screen saver program starts when there is no input from the player for five minutes in the stop mode. When the screen saver program is activated for 30 minutes, the power is automatically turned off.

- **Subtitles in a desired language**

You can select a desired language for the display subtitles, if that language is available on a disc.

- **Selecting a camera angle**

You can select the desired camera angle, if a disc contains sequences recorded from different angles.

- **Choices for audio language and sound mode**

You can select the desired audio language and sound mode, if different languages and modes are available on a disc.

- **Parental lock**

You can set the control level to limit playback of discs which may not be suitable for children.

- **Automatic detection of discs**

This player automatically detects if a loaded disc is DVD or audio CD.

- **On-screen display**

Information about the current operation can be displayed on a TV screen, allowing you to confirm the currently active functions (such as program playback), on the TV screen using the remote control.

- **DTS (Digital Theater System)**

Sound system different from Dolby Digital sound system

- **Search**

Chapter search: Search for the chapter designated by user is possible.

Title search: Search for the title designated by user is possible.

Track search: Search for the track designated by user is possible.

Time search: Search for the time designated by user is possible.

- **Repeat**

Chapter: Repeated playback of the chapter of the disc being played is possible.

Title: Repeated playback of the title of the disc being played is possible.

Track: Repeated playback of the track of the disc being played is possible.

Disc(audio CD): Repeated playback of the entire disc being played is possible.

A-B: The part between A and B designated by user is possible.

- **Zoom**

4-time magnified screen can be displayed.

- **Marker**

The part designated by user can be called back.

- **Resume Play**

User can resume to playback from the part at which the play was stopped.

- **SRS TruSurround**

You can enjoy stereophonic virtual space on your existing stereo system.

- **Component Video Out Jacks**

Jacks located on the back of the DVD Player which are used to send high-quality video to a TV switch Component Video In Jacks.

- **Dimmer**

Brightness of the display can be varied.

- **Bit rate indication**

- **Dynamic range control**

This unit employs TruSurround system

TruSurround[™] by **SRS** (●) of SRS Labs, Inc. as virtual technology.



TruSurround and the (●)[®] symbol are trademarks of SRS Labs, Inc.

TruSurround technology is incorporated under license from SRS Labs, Inc.

ABOUT THE DISCS

PLAYABLE DISCS

The following discs can be played back on this DVD player.

Disc Type	Logo	Contents	Disc Size	Maximum Playback Time
DVD Video		Sound and Pictures	12 cm	Approx. 4 h (single-sided) Approx. 8 h (double-sided)
			8 cm	Approx. 80 min (single-sided) Approx. 160 min (double-sided)
Audio CD		Sound	12 cm	74 min
			8 cm (singles)	20 min

This player conforms to the NTSC color system. You cannot play discs recorded in other color systems such as PAL or SECAM.

- Some discs include region codes as shown below.



- The number inside the symbol refers to a region of the world, and a disc encoded in a specific region format can only be played back on DVD players with the same region code.

The following discs cannot be played back on this DVD player.

- DVD with region codes other than 1 or ALL.
- DVD-ROM
- DVD-RAM (Never play back, otherwise malfunction may result.)
- CD-ROM
- VSD
- CDV (Only plays back the audio part.)
- CD-G (Only plays back the sound.)
- CD-R (Never play back, otherwise malfunction may result.)
- CD-I (Never play back, otherwise malfunction may result.)

- Photo CD (Never play back, otherwise malfunction may result.)
- Video CD (Never play back, otherwise malfunction may result.)

Any other discs without compatibility indications

DISC TYPES

[DVD]

Data on a DVD is divided into sections called "titles", and then into subsections called "chapters", each of which is given a title or chapter number. Playback conditions are preset on some DVD video discs, and these playback conditions take priority over user operations on this player. If a function you selected does not run as desired, refer to the manual accompanying the disc.

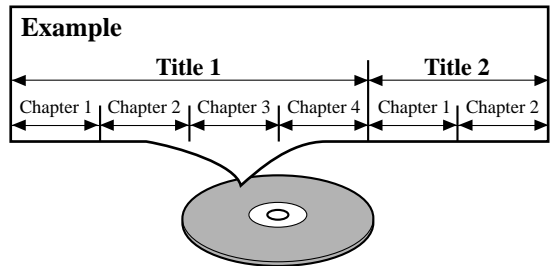

[AUDIO CD]

Data on an audio CD is divided into sections called "tracks", each of which is given a track number.

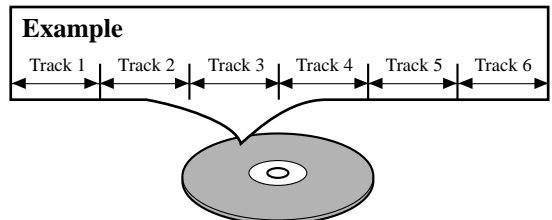

OPERATING CONTROLS AND FUNCTIONS

FRONT PANEL

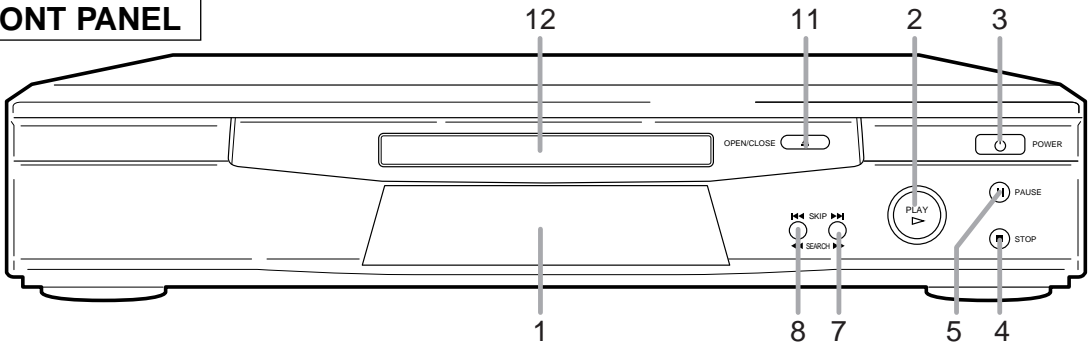

REMOTE CONTROL

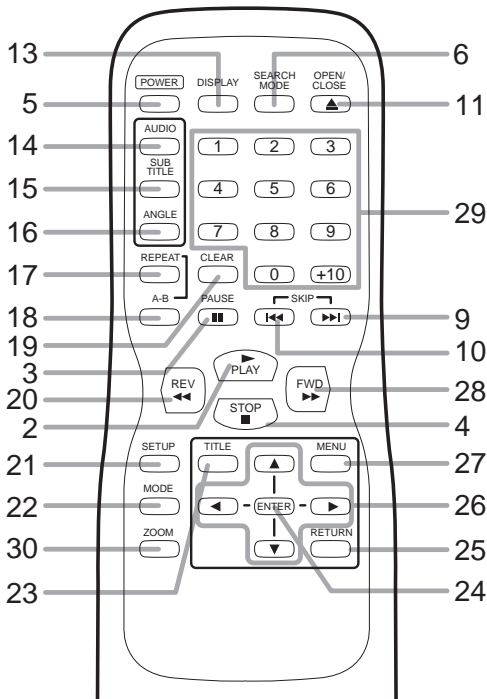

1. Display, Remote Sensor Window

2. PLAY Button [page 13]

Starts playback of the disc contents.

3. PAUSE Button [page 14]

Pauses the current disc operation.

4. STOP Button [page 14]

Stops operation of the disc.

5. POWER Button [page 13]

Press to turn the power on and off.

6. SEARCH MODE Button [pages 15,16]

Press to locate a desired point.

7. SKIP UP/FWD Button (main unit)

Plays back from the beginning of the next chapter or track. Hold down to fast forward playback.

8. SKIP DOWN/REV Button (main unit)

Plays back from the beginning of the current chapter or track. Hold down to fast reverse playback.

9. SKIP UP Button (remote control)

Plays back from the beginning of the chapter or track.

10. SKIP DOWN Button (remote control)

Plays back from the beginning of the current chapter or track.

11. OPEN/CLOSE Button [page 13]

Press to insert discs into or remove them from the tray.

12. Disc loading tray

13. DISPLAY Button [page 20]

Displays the current status on the TV screen for checking purposes.

14. AUDIO Button [page 18]

Press to select a desired audio language or sound mode.

15. SUBTITLE Button [page 19]

Press to select a desired subtitle language.

16. ANGLE Button [page 19]

Press to change the camera angle to see the sequence being played back from a different angle.

17. REPEAT Button [page 16]

Repeats playback of the current disc, title, chapter or track.

18. A-B REPEAT Button [page 17]

Repeats playback of a selected section.

19. CLEAR Button [pages 17]

Resets a setting.

20. REV Button

Fast reverse playback to a desired point.

21. SETUP Button [page 21]

Press to enter the setup mode or to change setup items.

22. MODE Button [pages 16,17]

Activates program playback or random playback mode.

23. TITLE Button [page 14]

Displays the title menu.

24. ENTER Button

Press to accept a setting.

25. RETURN Button

Returns to the previous operation.

26. Arrow Buttons

Use when making settings while watching the display on a TV screen.

27. MENU Button [page 13]

Displays the DVD menus.

28. FWD Button [page 15]

Fast forwards playback to a desired point.

29. Numeric Buttons [page 16]

30. ZOOM Button

Enlarges part of a DVD-reproduced image.

REAR VIEW

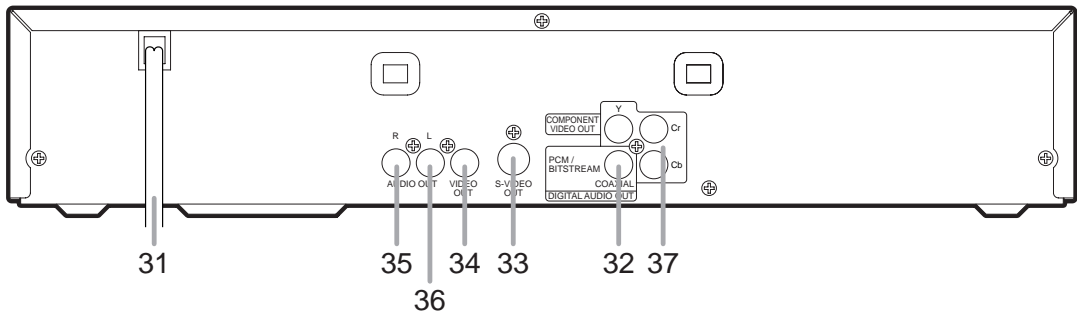

- 31. Power Cord
- 32. COAXIAL DIGITAL AUDIO OUT Jack
- 33. S-VIDEO OUT Jack
- 34. VIDEO OUT Jack

- 35. Right AUDIO OUT Jack
- 36. Left AUDIO OUT Jack
- 37. Component Video Out Jacks

DISPLAY

Stays on when the A-B repeat function is on.

Stays on when the repeat function is on.

Lights up when a DVD is inserted on the tray.

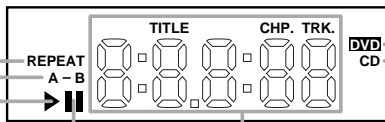

Lights up when the inserted disc comes to a pause.

Lights up when a CD is inserted on the tray.

Stays on when the inserted disc is being played back.

Displays how long a current title or track has been played back. When a chapter or track has switched, the number of a new title, chapter or track is displayed. (in the search mode or when the skip up/down button is pressed.)

DISPLAYS DURING OPERATION

	Power on
	No disc inserted
	Tray open
	Tray closed
	Loading the Disc
	Power off

LOADING THE BATTERIES

1. Open the battery compartment cover.
2. Insert two AA batteries, with each one oriented correctly.
3. Close the cover.

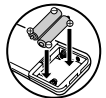

Notes

- Do not mix alkaline and manganese batteries.
- Do not mix old and new batteries.

HOOKUPS

CONNECTING TO A TV

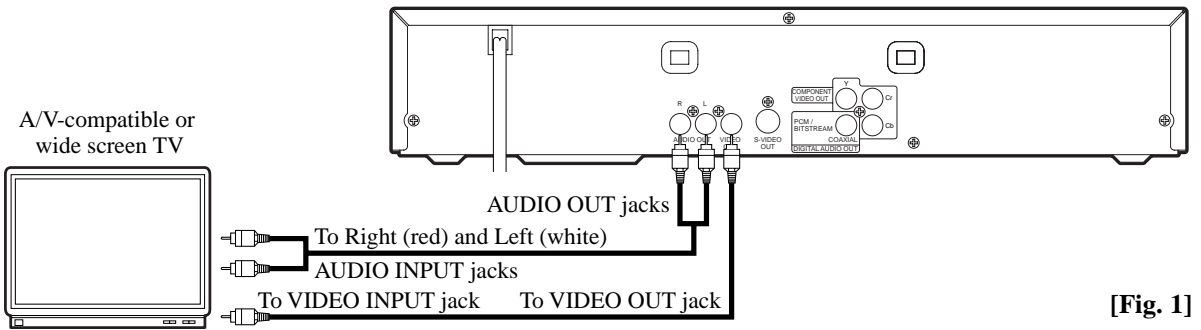

FOR TVs WITH S-VIDEO INPUT JACK

Use an S-Video cable (commercially available) in place of the yellow video cable to enjoy pictures at higher quality.

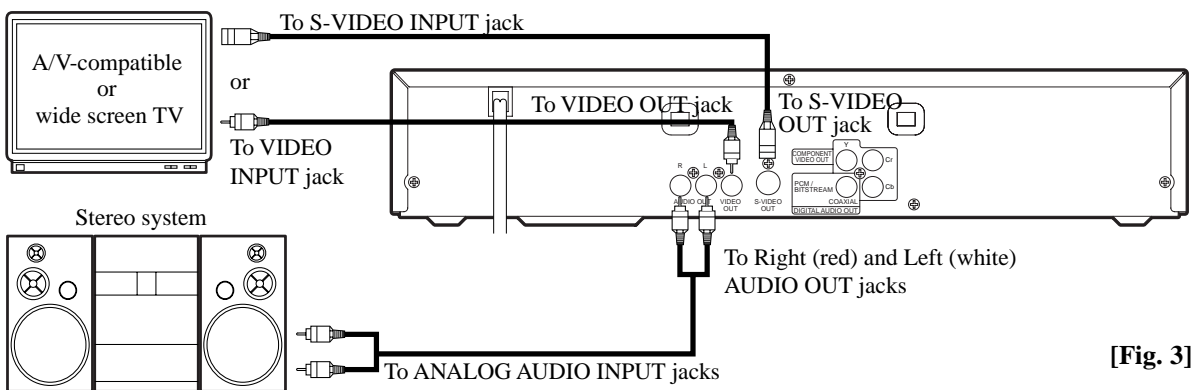
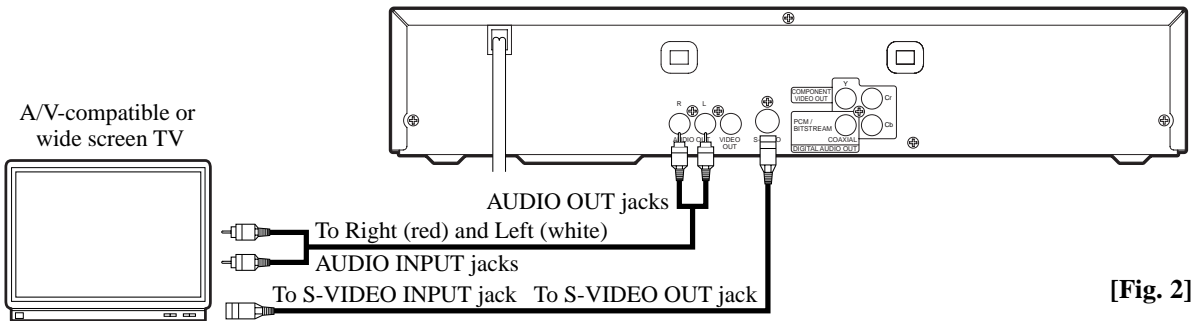

Notes

- Connect the DVD player directly to a TV. If the A/V cables are connected to a VCR, pictures may be distorted due to the copy protection system.
- Be sure to turn off the power to all components in the system before connecting another component.
- Refer to the Owner's Manuals for your TV, stereo system and any other components to be connected to the DVD player.

CONNECTING TO AN AMPLIFIER EQUIPPED WITH DIGITAL INPUT JACKS, MD DECK OR DAT DECK

Use audio coaxial digital cables (commercially available) for the audio connections.

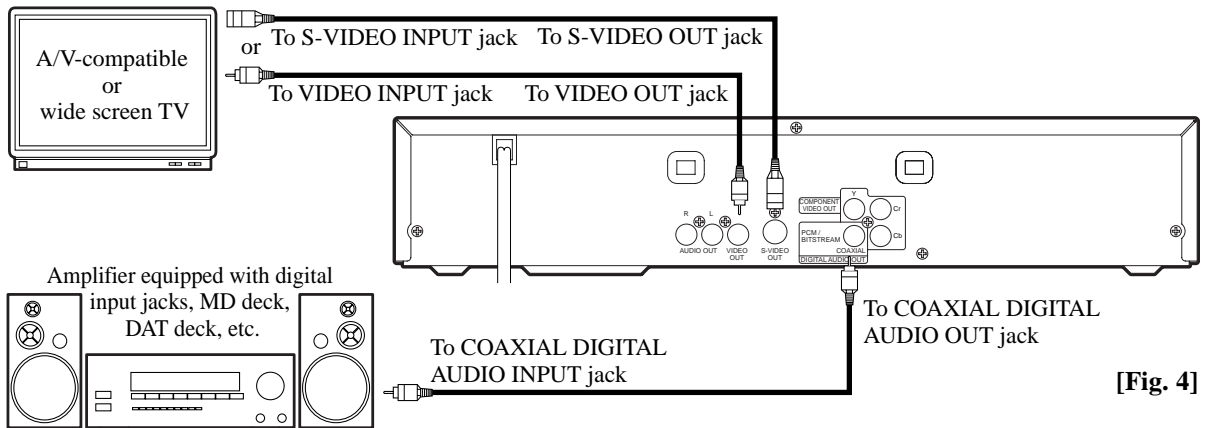

CONNECTING TO A TV OR A STEREO TV THAT HAS COMPONENT VIDEO IN JACKS

Set Dolby Digital and DTS to OFF on the DVD Player. If you play a DVD when the settings are wrong, the sound will be distorted or you may damage the speakers.

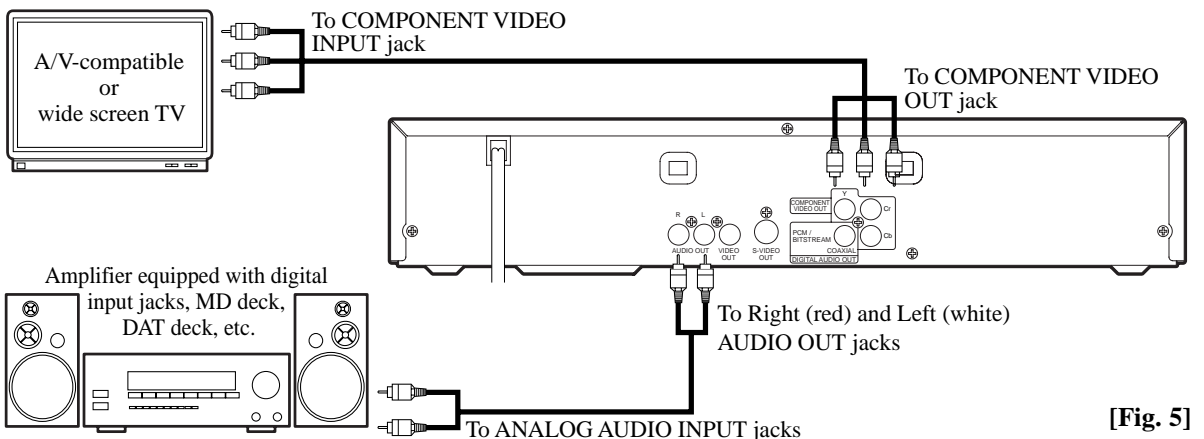

Notes

- The audio source on a disc in a 5.1 channel Dolby Digital surround format cannot be recorded as digital sound by an MD or DAT deck.
- Be sure to turn off the power to all components in the system before connecting another component.
- Refer to the Owner's Manuals for the components to be connected to the DVD player.
- Set Dolby Digital and DTS to off for audio output in the setup mode. Playing a DVD using incorrect settings may generate noise distortion, and may also damage the speakers.

HOW TO CONNECT TO A TV WITHOUT AUDIO/VIDEO INPUT JACKS

If your TV does not have RCA type audio and video input jacks it is still possible to connect this DVD player to your TV's 75-ohm coaxial antenna terminal using an optional Stereo Audio/Video RF Modulator, not included. Connect the audio and video outputs of the DVD player to the audio and video inputs on the RF Modulator, and then connect the coaxial output of the RF Modulator (usually marked "TO TV") to the 75 ohm coaxial antenna terminal on your TV. Follow the instruction supplied with the RF Modulator for more details.

If your TV's 75 ohm coaxial antenna terminal is already occupied by an antenna or cable box connection, remove that cable from your TV's antenna terminal and reconnect it to the coaxial antenna input terminal of the RF Modulator (usually marked "ANT IN"), then connect the RF modulator to your TV's antenna terminal as described above.

Note

- The picture quality from DVD discs will not be as good if the DVD player is connected to the TV's antenna terminal through an RF Modulator.

CONNECTING TO A DOLBY DIGITAL DECODER OR DTS DECODER

If using this DVD player to play back a DVD in a 5.1 channel Dolby Digital surround or DTS surround format, the DVD player outputs a Dolby Digital or DTS data stream from its COAXIAL DIGITAL AUDIO OUT jack. By hooking the player up to a Dolby Digital or DTS decoder, you can enjoy a more convincing, realistic ambience with powerful and high-quality surround sound of a professional standard such as can be heard in movie theaters.

Use audio coaxial digital cables (commercially available) for the audio connections.

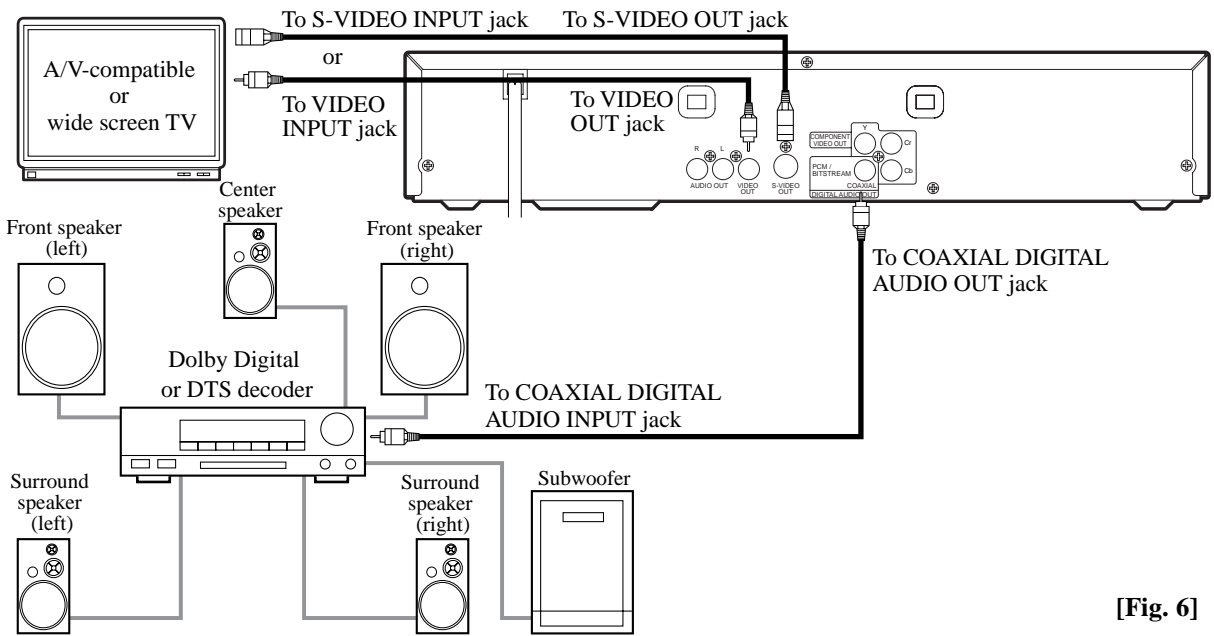

[Fig. 6]

Notes

- Be sure to turn off the power to all components in the system before connecting another component.
- Refer to the Owner's Manuals for the components to be connected to the DVD player.
- If connected to a Dolby Digital decoder, set Dolby Digital to on for audio output in the setup mode.
- If connected to a DTS decoder, set DTS to ON for audio output in the setup mode.
- Unless connected to a Dolby Digital decoder or a DTS decoder, set Dolby Digital and DTS to off for audio output in the setup mode. Playing a DVD using incorrect settings may generate noise distortion, and may also damage the speakers.

Manufactured under license from Dolby Laboratories. "Dolby" and the double-D symbol are trademarks of Dolby Laboratories. Confidential Unpublished Works. ©1992-1997 Dolby Laboratories, Inc. All rights reserved.

DTS is a trademark of Digital Theater Systems Inc. in the United States of America.

PLAYING A DISC

PLAYING A DVD VIDEO OR AN AUDIO CD

DVD

CD

Getting started

Turn on the power of the TV, amplifier and any other components which are connected to the DVD player. (Change the input system to suit the DVD player, and check that the sound volume is correct.)

1 Press the POWER button.

- The power will turn on.

2 Press the OPEN/CLOSE button.

- The disc loading tray will open.

3 Place a disc into the tray.

- Make sure the disc is sitting properly in the correct recess, with the label side up.

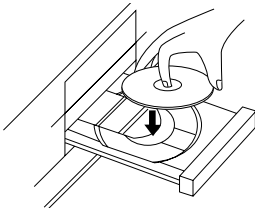

4 Press the PLAY button.

- The tray will close automatically, and playback will then start from the first chapter or track of the disc. You need to press the PLAY button only when the tray has been closed by pressing the OPEN/CLOSE button.
- When you play back the DVD which a title menu is recorded, the menu may appear on the screen. In this case, refer to "USING THE TITLE MENU".

5 Press the STOP button to stop play.

Notes

- A "prohibited icon" may appear at the top-right on the TV screen during operation, warning that a prohibited operation has been encountered by the DVD player or the disc. 
- If a disc is dirty or has scratches, the pictures may appear distorted and the playback operation may stop. In such cases, clean the disc and unplug the power cord and then plug it again before resuming playback.
- With DVDs that use some titles for playback program signals, playback may start from the second title, or it may skip these titles.

USING THE DVD MENUS

DVD

Some DVDs contain their own menus, such as a guidance menu which describes the contents of the disc or a selection menu for sound, language and other customized settings.

1 Press the MENU button.

- The DVD menu will appear.

2 Select the desired title.

- Press the arrow buttons (▼/▲/▶/◀) to change the setting, and then press the ENTER button.

3 Playback will start from the selected title.

USING THE TITLE MENU

DVD

With a DVD containing a title menu, you can select desired titles from the menu.

1 Press the TITLE button.

- The title menu will appear.

2 Select the desired title.

- Press the arrow buttons (▼/▲/▶/◀) to change the setting, and then press the ENTER button.

CALLING UP A MENU SCREEN DURING PLAYBACK

For DVDs

- Press the MENU button to call up the DVD menu.
- Press the TITLE button to call up the title menu.

Note

- Contents of menus and corresponding menu operations may vary between discs. Refer to the manual accompanying the disc for details.

RESUMING PLAYBACK FROM THE POINT WHERE PLAYBACK STOPPED

DVD

CD

1 Press the STOP button during playback.

- Playback will stop, and then appear the resuming message at the center.

Press 'PLAY' to play from here
To play beginning, press 'STOP' first
and then 'PLAY'.

2 Press the PLAY button. Playback will start from the point where the previous playback session was stopped.

Play ▶

Note

- The resume function can be reset by pressing the STOP button twice or by opening the disc loading tray.

PAUSING PLAYBACK OR DISPLAYING A STILL PICTURE

DVD

CD

1 Press the PAUSE button during playback.

- Playback will pause, with sound muted.

Pause ||

2 Press the PLAY button to resume playback.

Play ▶

STEPPING THROUGH FRAMES

DVD

1 Press the PAUSE/STILL button while playback is paused.

- The next picture frame is displayed with sound muted each time the button is pressed.

Pause ||

2 Press the PLAY button to resume playback.

Play ▶

FAST FORWARD/REVERSE

DVD

CD

1 Press the FWD ►► or REV ◀◀ button during playback.

- For DVDs, pressing the FWD ►► or REV ◀◀ button cycles the playback speed in three steps.
- For audio CDs, the playback speed is ×16 fixed.

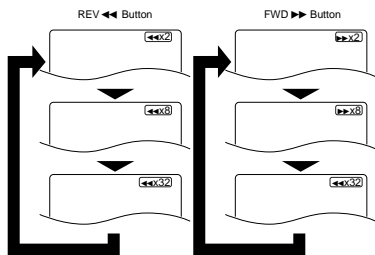

2 Press the PLAY button to return to normal playback speed.

SLOW MOTION

DVD

1 Press the FWD ►► button while playback is paused. (Sound remains muted.)

- Slow motion mode will be activated.
- Pressing the FWD ►► button cycles the playback speed in three steps. Select an appropriate speed while referring to the speed indication on the screen.

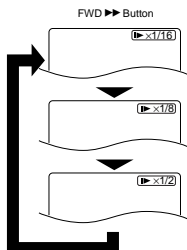

2 Press the PLAY button to return to normal playback speed.

Notes

- Slow playback is not available with audio CDs.
- The reverse of slow playback is not available.

STARTING FROM A DESIRED TRACK

CD

1 Press the numeric buttons to enter the desired track number.

- The selected track will be located, and playback will start. You can also press the SEARCH MODE button, use the numeric buttons to enter the track number, when the track number is entered in the entry box, playback of the desired track will start automatically.

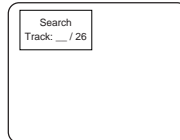

TRICKS WITH THE SKIP BUTTONS (◀◀, ►►)

If the SKIP button ►► is pressed during playback or while playback is paused, the current track is skipped and the next track is played. When the SKIP button ◀◀ is pressed once, the top of the current track is located for replaying. When the SKIP button ◀◀ is pressed again while Within 2-second playback, the previous track is located.

STARTING FROM A DESIRED TIME COUNT

DVD

CD

1 Press the SEARCH MODE button.

- Press the button twice for DVDs or two times for audio CDs.

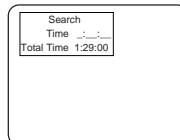

2 Press the numeric buttons to set the desired time count.

- **Example:** 1 hour, 23 minutes and 30 seconds
1 → 2 → 3 → 3 → 0

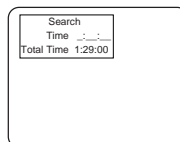

Notes

- In the case of DVD, Time Search in Title is effective. (But Time Search in Chapter is ineffective.)
- In the case of CD, Time Search in Track is effective. (But Time Search in the entire disc is ineffective.)
- Playback from a desired time count is not available with some discs.
- Specific time playback is not available with some discs or if the unit is in stop mode.

PLAYING FROM A DESIRED TITLE OR CHAPTER

DVD

You can also press the SEARCH MODE button, use the numeric buttons to enter the chapter number.

- Perform the title search and the chapter search after setting them on the same screen at the same time. Changeover by ▲/▼ buttons.

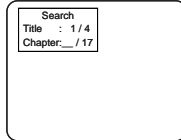
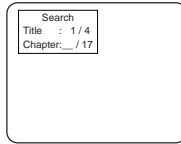

Note

- Playback from a desired title or chapter is not available with some DVDs.

RANDOM (Audio CD)

CD

1 Press the MODE button in stop mode.

- The program setting menu screen will appear.

2 Press the MODE button again.

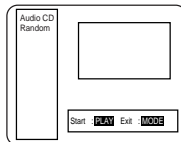

3 Press the PLAY button. Random playback will then start.

Note

- Program playback is not available during random playback.

REPEAT

DVD

CD

1 Press the REPEAT button.

For DVDs

- A single title or chapter is played back repeatedly.
- Pressing the REPEAT button cycles the display on the screen as follows.

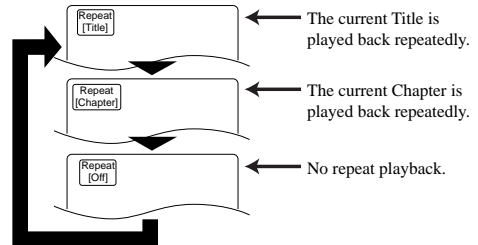

For audio CDs

- The whole disc or a single track is played back repeatedly.
- Pressing the REPEAT button cycles the display on the screen through **All**, **Repeat Track** and **Off**.

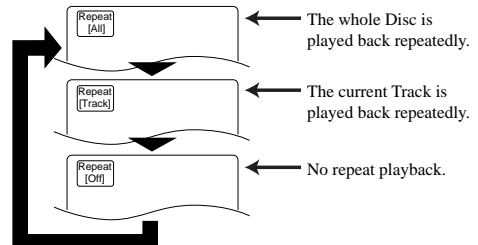

If the REPEAT button is pressed once during program/random playback, the program/random playback is performed repeatedly.

If the REPEAT button is pressed again, the current track is played back repeatedly.

Notes

- Repeat playback is not available with some discs.
- If the REPEAT setting will be cleared when moving to other title, chapter or track.

A-B REPEAT

DVD

CD

You can define a section to be played back repeatedly.

1 Press the A-B REPEAT button during playback.

- The starting point (A) will then be selected.

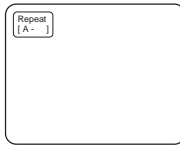

2 Press the A-B REPEAT button again at the end point (B) of the desired section.

- The selected section will be played back repeatedly.

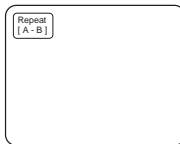

3 To exit A-B repeat playback, press the A-B REPEAT button and set it to OFF.

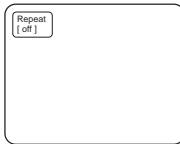

Notes

- With DVDs, the A-B repeat section can be set only within the current title.
- With audio CDs, the A-B repeat section can be set within the current track.
- A-B repeat is not available with some scenes in DVD.
- To cancel the A point which was set, press RETURN button.

PROGRAM (Audio CD)

CD

1 Press the MODE button in stop mode.

- The program screen will appear.

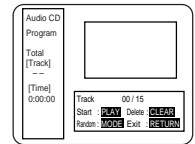

2 Press the numeric buttons to enter the desired track numbers.

- The total playback time for the selected tracks will appear on the TOTAL line.

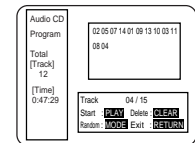

3 Press the PLAY button.

- Playback will start in the programmed order.
- While the program is being played back, the STOP button works as follows.
- Press the STOP button once and then the PLAY button again, playback will restart from the point where the STOP button was pressed. (Program continued)
- Press the STOP button twice and then the PLAY button again, playback will restart from the first tune in the program in the usual way. (Program continued)
- Press the STOP button three times and then the PLAY button again, playback will restart from the track in the usual way. (Program cleared)

Notes

- Adding programs is not possible during program playback. You must stop the current playback before such operations can be carried out.
- Press the CLEAR button to cancel a program. The most recently entered program will then be deleted.
- Numbers which exceed the number of tracks on the disc in the tray are not accepted.
- Playback from a desired track and random playback are not available during program playback.
- Program settings are cleared when the power is turned off or the disc loading tray is opened.
- If the track no. is once set in the program, the setting cannot be changed.

SETTINGS

ZOOM PLAYBACK (enlargement onscreen)

DVD

Images can be enlarged four times on the screen to your taste.

Press the **ZOOM** button during playback.

- An image will be enlarged at the center of the screen.
- Press the **ZOOM** button again, and the image will be back to the previous size.

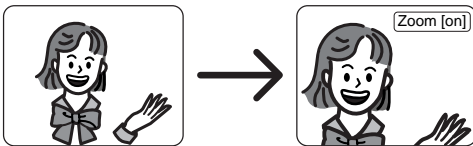

When the cursor (**▲/▼/◀/▶**) button is pressed during zoom play, the part to be zoomed moves.

- The zooming frame can be moved from the center 4 steps to the right. 4 steps to the left. 4 steps to the top. 4 steps to the bottom.

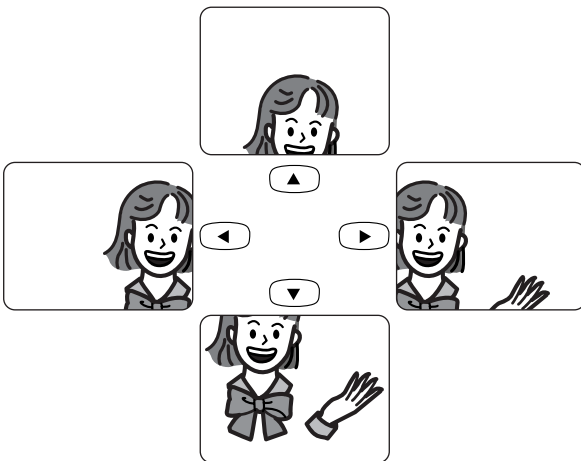

Note

- Zooming function does not work while operation display screen is shown.

CHANGING THE AUDIO LANGUAGE OR SOUND MODE

DVD

The DVD player has a function which allows you to select the desired audio language and sound mode.

For DVDs

Press the **AUDIO** button during playback, and then press the **AUDIO** button to select the desired audio language.

- The audio language can be changed if multiple languages are recorded on the DVD being played.

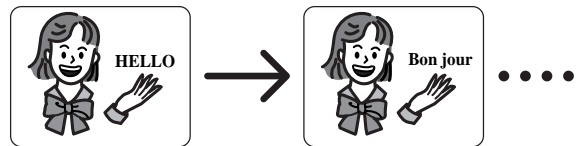
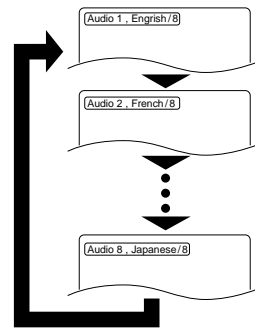

Notes

- Pressing the Audio button may not work on some DVDs with multiple audio languages (e.g. DVDs which allow audio language setting on the disc menu). Operation varies between discs, so refer to the manual accompanying the disc.
- If a desired language is not shown after pressing the Audio button several times, the disc does not have an audio source in that language.
- The audio language resets to the one which has been selected in the setup mode, every time the power is turned on or discs are replaced. If that language is not available on a disc, a language defined by the disc is selected.
- The screen display will disappear after about 5 seconds.

CHANGING THE SUBTITLE LANGUAGE

DVD

The DVD player has a function which allows you to select the desired language for subtitles.

Press the **SUBTITLE** button during playback, and then press the **SUBTITLE** button to select the desired subtitle language.

- The subtitle language can be changed if the subtitles are recorded in multiple languages on the DVD being played.
- The subtitle language cannot be changed if the subtitles are recorded in a single language on the DVD being played.

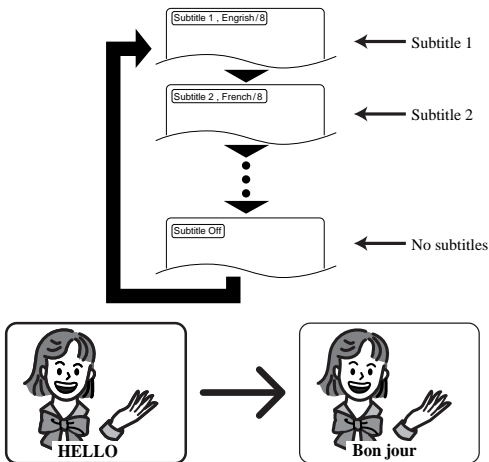

- Pressing the **SUBTITLE** button cycles the subtitle language from **SUBTITLE 1**, **SUBTITLE 2** and all the languages recorded through to off.

Notes

- Some discs allow subtitle language setting on the disc menu. (Operation varies between discs, so refer to the manual accompanying the disc.)
- If the desired language is not shown after pressing the **SUBTITLE** button several times, the disc does not have subtitles in that language.
- The subtitle language resets to the one which has been selected in the setup mode, every time the power is turned on or discs are replaced. If that language is not available on a disc, a language defined by the disc is selected.
- It may take time to display the subtitles in the selected language.
- The screen display will disappear after about 5 seconds.
- When “Subtitle Not Available” appears onscreen, it means no subtitle is recorded on the scene.

CHANGING THE CAMERA ANGLE (Multi-Angle Pictures)

DVD

The DVD player has a function which allows you to select the desired camera angle.

1 Press the **ANGLE** button during playback.

- If the disc contains sequences recorded from different camera angles, the angle icon (⏏) will appear at the top-right of the screen. You can change the camera angle when the icon appears on the screen.
- The camera angle cannot be changed if the disc does not contain sequences recorded from different camera angles.

2 Press the **ANGLE** button while the angle number is shown on the screen.

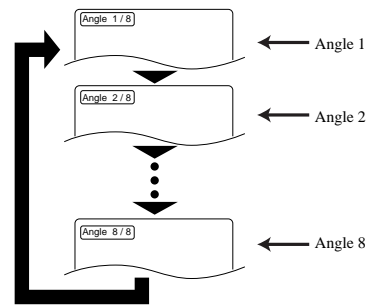

Note

- The screen display will disappear after about 5 seconds.

CHANGING THE ON-SCREEN DISPLAY

DVD

CD

You can check the information about the disc by pressing the DISPLAY button on the remote control.

For audio CDs and DVDs

1

Press the DISPLAY button, the display on the screen.

2

For the selecting the item of the Playback Setup Window, press the ▲/▼ button to select the item, then press the ENTER button.

For audio CDs

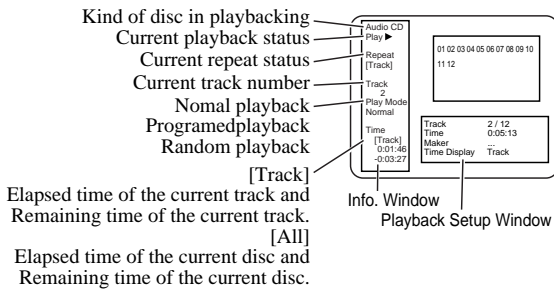

Playback Setup Window (CD)

ITEM	DISPLAY CONTENTS
Track	Current track number / the number of total tracks
Time	Total time of the current track
Marker	Place the cursor and press the ENTER button to activate the Marker function. [Set the marker] Using ▲/▼ button, position the cursor on to the marker number shown as "Not Set". Press the ENTER button when the screen to be reviewed appears. Up to 5 points can be marked. [Call back the marker] Using ▲/▼ button, position the cursor on to the marker number to be called back and press the ENTER button. [Clear the marker] Using ▲/▼ button, position the cursor on to the marker number to be cleared and press the CLEAR button. To clear all markers, place the cursor on "All Clear Markers" and press the ENTER button.
Time Display	The time informations displays on the left side of the screen (Track/All)

For DVDs

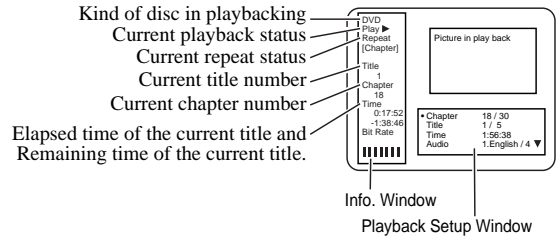

Playback Setup Window (DVD)

ITEM	DISPLAY CONTENTS
Chapter	Current chapter number / the number of total chapters
Title	Current title number / the number of total titles
Time	Total time of the current title
Audio	Audio No., audio language / the number of available audio languages in the disc
Subtitle	Subtitle No., subtitle language / the number of available subtitle languages in the disc Off : Subtitle is not displays. Not Available : Subtitle is not included.
Angle	Angle No. / total number of the angles 1/1 : Multi angle is not included in the disc.
Marker	Place the cursor and press the ENTER button to activate the Marker function. [Set the marker] Using ▲/▼ button, position the cursor on to the marker number shown as "Not Set". Press the ENTER button when the screen to be reviewed appears. Up to 5 points can be marked. [Call back the marker] Using ▲/▼ button, position the cursor on to the marker number to be called back and press the ENTER button. [Clear the marker] Using ▲/▼ button, position the cursor on to the marker number to be cleared and press the CLEAR button. To clear all markers, place the cursor on "All Clear Markers" and press the ENTER button.
SRS TruSurround	The current setting (On/Off) is displayed.

To exit the display (DVD and CD):

Press the RETURN button.

In the playback Setup Window, press the RETURN button to change the present indication to the former one.

CHANGING THE SETUP ITEMS

Note

- When you change the setup items, press the STOP button if you are in playback mode.

LANGUAGE SETTINGS

1 Press the SETUP button.

- The setup screen appears.

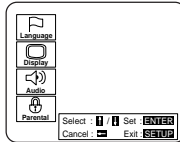

2 Press the ▲/▼ buttons to select Language, and then press the ENTER button.

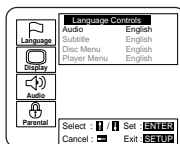

3 Press the ▲/▼ buttons to select an item, and then press the ENTER button.

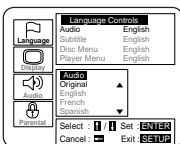

(Voice is played back in selected language.)

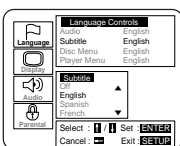

(Subtitles are shown in selected language.)

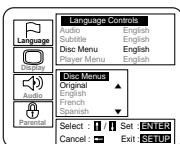

(The disc menu appears in selected language.)



(The on-screen display appears in selected language.)

4 Press the ▲/▼ buttons to select a desired item, and then press the ENTER button.

- If Other is selected on the Audio, Subtitle or Disc Menu setting screen, the Language Code setting screen will appear. Press the numeric buttons to enter the desired language code while referring to the list on page 25.

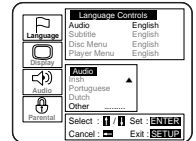

5 Press the SETUP button.

- The setup mode will be canceled and the ordinary screen will appear.

Note

- Language Setting for Audio and Subtitle is not available with some discs. Then use the Audio and Subtitle button. Details are on pages 18 and 19.

DISPLAY SETTINGS

1 Press the SETUP button.

- The setup screen will appear.

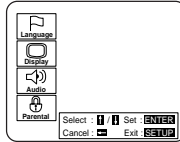

2 Press the ▲/▼ buttons to select Display and then press the ENTER button.

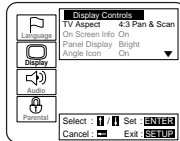

3 Press the ▲/▼ buttons to select an item, and then press the ENTER button.

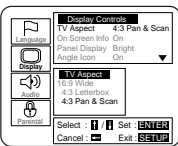

TV Aspect
(Default : 4:3 Pan & Scan)
4:3 Pan & Scan : Full height picture, trimmed both sides
4:3 Letter Box : Wide screen with black bars on top and bottom
16:9 wide : If wide screen TV is connected

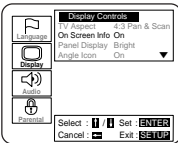

On Screen Info (Default : On)
Display or not display the disc status (Example "PLAY▶").

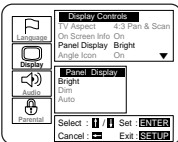

Panel Display (Default : Bright)
Adjust the brightness of the display of the unit.
* Auto: Stays dim only during playback.

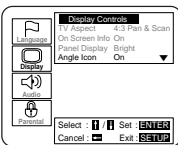

Angle Icon (Default : On)
Display or not display the Angle icon on the screen.

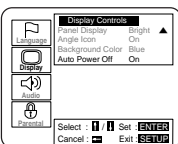

Auto Power Off (Default : On)
Set or not set to turn off after the screen saver is started and no keys are pressed for 30 minutes.

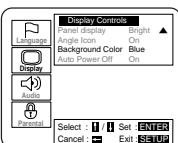

Background Color (Default : Blue)
Select blue or gray.

- 4 Press the ▲/▼ buttons to select a desired item, and then press the ENTER button.

5 Press the SETUP button.

- The setup mode will be canceled and the ordinary screen will appear.

AUDIO SETTINGS

1 Press the SETUP button.

- The setup screen will appear.

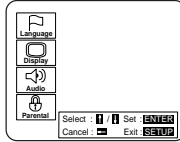

2 Press the ▲/▼ buttons to select Audio and then press the ENTER button.

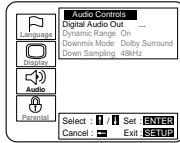

3 Press the ▲/▼ buttons to select an item, and then press the ENTER button.

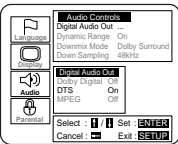

Digital audio out setting
(Next step)

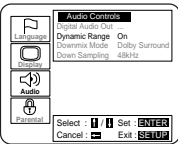

Dynamic Range (Default : Off)
On : Dynamic range is available

- This function is for controlling the range of sound volume. By compressing the range of sound volume, it is possible not only to suppress the output of loud sound at night and but also to raise the volume of low sound.
- However, this function is effective only for the sound recorded by Dolby Digital recording. When the sound recorded by Dolby Digital 5.1ch is outputted, the sound is compressed automatically even with this function being set at "Off".

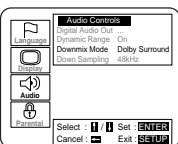

Downmix Mode
(Default: Dolby Surround)

Dolby Surround: When the player is connected to an audio component that conforms to
Dolby Surround Pro Logic
Stereo: When the player is connected to a normal audio component

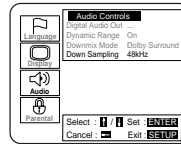

Down Sampling
(Default : 48kHz)
Set the output for the DVD recorded in PCM 96kHz (96kHz or 48kHz)

4 Press the ▲/▼ buttons to select a desired item, and then press the ENTER button.

- If PCM, Dolby Digital or DTS MPEG is selected on the Digital Audio Out setting screen, press the ▲/▼ buttons again to select a further item, and then press the ENTER button.

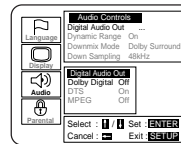

Dolby Digital (Default : Off)
On : Output by Dolby Digital

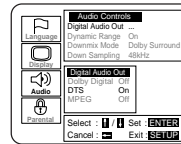

DTS (Default : Off)
On : Output DTS sound

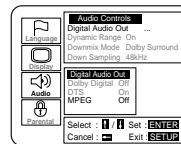

MPEG (Default : Off)
On : Output by MPEG
Off : Convert the MPEG to PCM

5 Press the SETUP button.

- The setup mode will be canceled and the ordinary screen will appear.

PARENTAL LOCK

1 Press the SETUP button.

- The setup screen will appear.

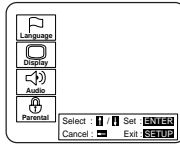

2 Press the ▲/▼ buttons to select Parental, and then press the ENTER button.

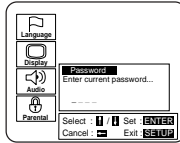

3 Press the numeric buttons to enter the 4-digit password, and then press the ENTER button.

- When doing this for the first time, enter any 4 digits. That number will be used as the password from the second time onward.
- By entering the password, you can then change the control level and password settings.

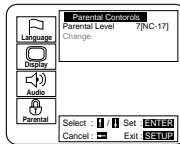

4 Press the ▲/▼ buttons to select an item, and then press the ENTER button.

When Parental Level is selected

- Press the ▲/▼ buttons to select an item from 8 to 1 and then press the ENTER button.
- When Change is selected, press the numeric buttons to enter the four digits password. Then press the ENTER button.

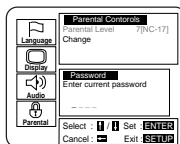
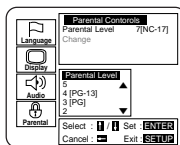

5 Press the RETURN button.

- The setup screen will appear.

CONTROL LEVELS

- **Level 8**
DVD software of any grade (adult/general/children) can be played back.
- **Levels 7 to 2**
Only DVD software intended for general use and children can be played back.
- **Level 1**
Only DVD software intended for children can be played back, with those intended for adult and general use prohibited.

Notes

- With some DVDs, it may be difficult to find if they are compatible with parental lock. Be sure to check if the parental lock function operates in the way that you have set.
- Record the password in case you forget it.

IF YOU FORGET THE PASSWORD

- 1) Open the tray.
- 2) Press the 1, 2, 3, 4, then DISPLAY button on the remote control. the default setup screen will appear. Then, press the ENTER button.
- 3) Disconnect the power once and reconnect, then proceed the step 1 to 4 of the PARENTAL LOCK again.

Note: If you proceed the above steps, ALL the settings of the DVD player will be cleared. To use the DVD player under the previous settings, set each setting item all over again.

LANGUAGE CODE LIST

No.	Language	Country code	No.	Language	Country code
1	Afar	4 7 4 7	69	Latvian;Lettish	5 8 6 8
2	Abkhazian	4 7 4 8	70	Malagasy	5 9 5 3
3	Afrikaans	4 7 5 2	71	Maori	5 9 5 5
4	Amharic	4 7 5 9	72	Macedonian	5 9 5 7
5	Arabic	4 7 6 4	73	Malayalam	5 9 5 8
6	Assamese	4 7 6 5	74	Mongolian	5 9 6 0
7	Aymara	4 7 7 1	75	Moldavian	5 9 6 1
8	Azerbaijani	4 7 7 2	76	Marathi	5 9 6 4
9	Bashkir	4 8 4 7	77	Malay	5 9 6 5
10	Byelorussian	4 8 5 1	78	Maltese	5 9 6 6
11	Bulgarian	4 8 5 3	79	Burmese	5 9 7 1
12	Bihari	4 8 5 4	80	Nauru	6 0 4 7
13	Bislama	4 8 5 5	81	Nepali	6 0 5 1
14	Bengali;Bangla	4 8 6 0	82	Dutch	6 0 5 8
15	Tibetan	4 8 6 1	83	Norwegian	6 0 6 1
16	Breton	4 8 6 4	84	Occitan	6 1 4 9
17	Catalan	4 9 4 7	85	(Afan)Oromo	6 1 5 9
18	Corsican	4 9 6 1	86	Oriya	6 1 6 4
19	Czech	4 9 6 5	87	Panjabi	6 2 4 7
20	Welsh	4 9 7 1	88	Polish	6 2 5 8
21	Danish	5 0 4 7	89	Pashto;Pushto	6 2 6 5
22	German	5 0 5 1	90	Portuguese	6 2 6 6
23	Bhutani	5 0 7 2	91	Quechua	6 3 6 7
24	Greek	5 1 5 8	92	Rhaeto-Romance	6 4 5 9
25	English	5 1 6 0	93	Kirundi	6 4 6 0
26	Esperanto	5 1 6 1	94	Romanian	6 4 6 1
27	Spanish	5 1 6 5	95	Russian	6 4 6 7
28	Estonian	5 1 6 6	96	Kinyarwanda	6 4 6 9
29	Basque	5 1 6 7	97	Sanskrit	6 5 4 7
30	Persian	5 2 4 7	98	Sindhi	6 5 5 0
31	Finnish	5 2 5 5	99	Sangho	6 5 5 3
32	Fiji	5 2 5 6	100	Serbo-Croatian	6 5 5 4
33	Faroese	5 2 6 1	101	Singhalese	6 5 5 5
34	French	5 2 6 4	102	Slovak	6 5 5 7
35	Frisian	5 2 7 1	103	Slovenian	6 5 5 8
36	Irish	5 3 4 7	104	Samoan	6 5 5 9
37	Scots Gaelic	5 3 5 0	105	Shona	6 5 6 0
38	Galician	5 3 5 8	106	Somali	6 5 6 1
39	Guarani	5 3 6 0	107	Albanian	6 5 6 3
40	Gujarati	5 3 6 7	108	Serbian	6 5 6 4
41	Hausa	5 4 4 7	109	Siswat	6 5 6 5
42	Hindi	5 7 5 5	110	Sesotho	6 5 6 6
43	Croatian	5 4 6 4	111	Sundanese	6 5 6 7
44	Hungarian	5 4 6 7	112	Swedish	6 5 5 8
45	Armenian	5 4 7 1	113	Swahili	6 5 6 9
46	Interlingua	5 5 4 7	114	Tamil	6 6 4 7
47	Interlingue	5 5 5 1	115	Telugu	6 6 5 2
48	Inupiak	5 5 5 7	116	Tajik	6 6 5 3
49	Indonesian	5 5 6 0	117	Thai	6 6 5 4
50	Icelandic	5 5 6 5	118	Tigrinya	6 6 5 5
51	Italian	5 5 6 6	119	Turkmen	6 6 5 7
52	Hebrew	5 5 6 9	120	Tagalog	6 6 5 8
53	Japanese	5 6 4 7	121	Setswana	6 6 6 0
54	Yiddish	5 6 5 5	122	Tonga	6 6 6 1
55	Javanese	5 6 6 9	123	Turkish	6 6 6 4
56	Georgian	5 7 4 7	124	Tsonga	6 6 6 5
57	Kazakh	5 7 5 7	125	Tatar	6 6 6 6
58	Greenlandic	5 7 5 8	126	Twi	6 6 6 9
59	Cambodian	5 7 5 9	127	Ukrainian	6 7 5 7
60	Kannada	5 7 6 0	128	Urdu	6 7 6 4
61	Korean	5 7 6 1	129	Uzbek	6 7 7 2
62	Kashmiri	5 7 6 5	130	Vietnamese	6 8 5 5
63	Kurdish	5 7 6 7	131	Volapuk	6 8 6 1
64	Kirghiz	5 7 7 1	132	Wolof	6 9 6 1
65	Latin	5 8 4 7	133	Xhosa	7 0 5 4
66	Lingala	5 8 6 0	134	Yoruba	7 1 6 1
67	Laothian	5 8 6 1	135	Chinese	7 2 5 4
68	Lithuanian	5 8 6 6	136	Zulu	7 2 6 7

[Fig. 6]

TROUBLESHOOTING GUIDE

If the DVD player does not perform properly when operated as instructed in this Owner's Manual, check the player, consulting the following checklist.

Symptom	Cause	Remedy
No power	<ul style="list-style-type: none"> ● Loose power plug. 	<ul style="list-style-type: none"> ● Insert the power plug firmly into the wall outlet.
The player does not respond to the remote control.	<ul style="list-style-type: none"> ● The remote control is not aimed at the sensor on the player. ● Obstacles present between the remote control and the sensor. ● The remote control is too far away from the player. ● Dead batteries. 	<ul style="list-style-type: none"> ● Aim the remote control directly at the sensor on the player. ● Remove the obstacles from the signal path. ● Use the remote control within 7m of the player. ● Replace the batteries.
No picture	<ul style="list-style-type: none"> ● Loose video connection. ● Wrong disc. 	<ul style="list-style-type: none"> ● Connect the video cables firmly. ● Insert a correct video disc that plays on this player.
Disc cannot be played	<ul style="list-style-type: none"> ● No disc. ● Dirty disc. ● Disc is placed upside down. ● Parental lock is active. 	<ul style="list-style-type: none"> ● Insert a disc. ● Clean the disc. ● Place the disc correctly, with the label side up. ● Cancel the parental lock or change the control level.
No sound	<ul style="list-style-type: none"> ● Loose audio connection. ● The power of the connected audio component is off. ● Wrong audio output settings. ● Wrong input settings on the connected audio component. 	<ul style="list-style-type: none"> ● Connect the audio cables firmly. ● Turn the power of the audio component on. ● Correct the audio output settings. ● Correct the input settings on the audio component.
Distorted picture	<ul style="list-style-type: none"> ● Copy protection is active. ● Immediately after playing, press fast forward or in reverse. 	<ul style="list-style-type: none"> ● Connect the player directly to the TV. ● There are some cases where pictures may be slightly distorted, which are not a sign of a malfunction.
Audio or subtitle language does not match the setup.	<ul style="list-style-type: none"> ● The selected language is not available for audio or subtitles on the DVD. 	<ul style="list-style-type: none"> ● No malfunction.
The camera angle cannot be changed.	<ul style="list-style-type: none"> ● The DVD does not contain sequences recorded from different camera angles. 	<ul style="list-style-type: none"> ● No malfunction.
Audio or subtitle language cannot be changed.	<ul style="list-style-type: none"> ● The DVD does not contain audio source or subtitles in the selected language. 	<ul style="list-style-type: none"> ● No malfunction.
“Prohibited icon” appears on the screen, prohibiting an operation.	<ul style="list-style-type: none"> ● That operation is prohibited by the player or disc. 	<ul style="list-style-type: none"> ● No malfunction.

Notes

Some functions are not available in specific modes, but this is not a malfunction. Read the description in this Owner's Manual for details on correct operations.

- Playback from a desired track and random playback are not available during program playback.

HANDLING PRECAUTIONS

SERVICING

Should your DVD player become inoperative, do not try to correct the problem by yourself. There are no user-serviceable parts inside. Turn off, unplug the power cord, and please call our help line at 1-800-968-3429, to locate an Authorized Service Center.

CABINET CLEANING

- Wipe the front panel and other exterior surfaces of the DVD player with a soft cloth immersed in lukewarm water and wrung dry.
- Never use a solvent or alcohol. Do not spray insecticide liquid near the DVD player. Such chemicals may cause damage and discoloration to the exposed surfaces.

IF THE LASER OPTICAL PICKUP UNIT IS DIRTY

- If the player still does not perform properly when it is operated while referring to the relevant sections and to "TROUBLESHOOTING GUIDE" in this Owner's Manual, the laser optical pickup unit may be dirty. Consult your dealer or an Authorized Service Center for inspection and cleaning of the laser optical pickup unit.

DISC HANDLING

- Use discs which have the following logos on them. (Optical audio digital discs.)



- Handle the discs so that fingerprints and dust do not adhere to the surfaces of the discs.

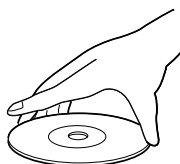
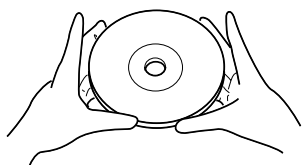

- Always store the disc in its protective case when it is not used.

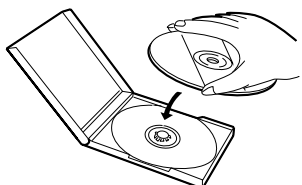

- To clean-off, use a soft cloth.
- Do not use a hard cloth since this will mar the disc.
- Wipe the disc in a straight line from center to edge.
- Never wipe with a circular motion.

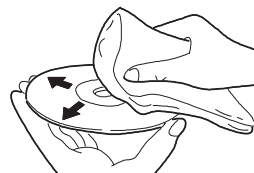

- Do not use detergent or abrasive cleaning agents.

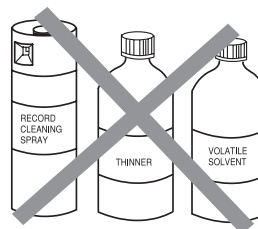

SPECIFICATIONS

Product type :	DVD Player
Discs :	DVD video Audio CD
Output signal format :	NTSC color
Frequency response	
DVD (linear sound) :	20 Hz to 22 kHz (sample rate: 48 kHz) 20 Hz to 44 kHz (sample rate: 96 kHz)
CD :	20 Hz to 20 kHz
Signal-to-noise ratio (S/N ratio)	
CD :	110 dB (EIAJ)
Dynamic range	
DVD (linear sound) :	95 dB
CD :	94 dB (EIAJ)
Total distortion factor	
CD :	0.007% (EIAJ)
Wow and flutter :	Below the measurement limitation (+/-0.001% W PEAK) (EIAJ)
Connections	
S-Video output :	Mini DIN 4-pin jack (75 ohm)
Video output :	One RCA connector, 1 Vpp (75 ohm)
Coaxial digital audio output :	One pin jack, 500mVpp (75 ohm)
Analog audio output :	Two RCA connectors (one left channel, one right channel) 2 Vrms (47 kilo-ohm)
Component video output :	One pin jack (Y), 1 Vpp (75 ohm) Two pin jacks (CB)/(CR), 700mVpp (75 ohm)
Power source :	120 V AC +/- 10%, 60 Hz +/- 0.5%
Power consumption :	17 W (standby: 5 W)
Operating temperature :	5°C to 40°C
Dimensions :	W 17-1/8" (435mm) H 3-11/32" (85mm) D 8-5/16" (211mm)
Weight :	5.07 lbs (2.3kg)

- **Designs and specifications are subject to change without notice.**
- **If there is a discrepancy between languages, the default language will be English.**

CONTROLES DE OPERACIÓN Y FUNCIONES

PANEL DELANTERO

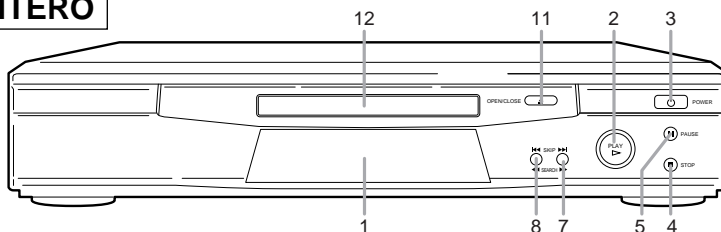

MANDO A DISTANCIA

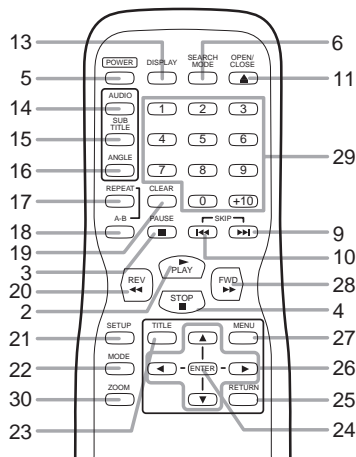

- 1. Visualizador, ventana del sensor del mando a distancia**
- 2. Botón de reproducción (PLAY)**
Inicie la reproducción del contenido del disco.
- 3. Botón de pausa (PAUSE)**
Hace una pausa en la operación del disco actual.
- 4. Botón de parada (STOP)**
Detiene la operación del disco.
- 5. Botón de la alimentación**
Púlselo para conectar y desconectar la alimentación.
- 6. Botón del modo de búsqueda (SEARCH MODE)**
Púlselo para localizar un punto deseado.
- 7. Botón de salto ascendente/avance rápido (SKIP UP/FWD) (Unidad principal)**
Inicia la reproducción desde el principio del capítulo o pista siguiente. Manténgalo pulsado para que la reproducción avance rápidamente.
- 8. Botón de salto descendente/retroceso rápido (SKIP DOWN/REV) (Unidad principal)**
Inicia la reproducción desde el principio del capítulo o pista actual. Manténgalo pulsado para que la reproducción retroceda rápidamente.
- 9. Botón de salto ascendente (SKIP UP) (Mando a distancia)**
Inicia la reproducción desde el principio del capítulo o pista.
- 10. Botón de salto descendente (SKIP DOWN) (Mando a distancia)**
Inicia la reproducción desde el principio del capítulo o pista actual.
- 11. Botón de apertura/cierre (OPEN/CLOSE)**

Púlselo para introducir discos en la bandeja o sacarlos de ella.

- 12. Bandeja de disco**
- 13. Botón de visualización (DISPLAY)**
Muestra el estado actual en la pantalla del televisor con fines de comprobación.
- 14. Botón de AUDIO**
Púlselo para seleccionar el modo de sonido o el idioma de audio deseado.
- 15. Botón de subtítulos (SUBTITLE)**
Púlselo para seleccionar el idioma de subtítulos deseado.
- 16. Botón de ángulos (ANGLE)**
Púlselo para cambiar el ángulo de la cámara y ver desde un ángulo diferente la secuencia que está siendo reproducida.
- 17. Botón de repetición (REPEAT)**
Repite la reproducción del disco, título, capítulo o pista actual.
- 18. Botón de repetición A-B (A-B REPEAT)**
Repite la reproducción de una sección seleccionada.
- 19. Botón de cancelación (CLEAR)**
Repone un ajuste.
- 20. Botón de retroceso (REV)**
Hace que la reproducción retroceda rápidamente hasta un punto deseado.
- 21. Botón de preparación (SETUP)**
Púlselo para entrar en el modo de preparación o para cambiar elementos de preparación.
- 22. Botón de modo (MODE)**
Activa el modo de reproducción programada o el modo de reproducción aleatoria.
- 23. Botón de titulación (TITLE)**
Visualiza el menú de títulos.
- 24. Botón de introducción (ENTER)**
Púlselo para aceptar un ajuste.
- 25. Botón de retorno (RETURN)**
Púlselo para volver a la operación anterior.
- 26. Botones de flechas**
Utilícelos cuando haga ajustes mientras ve la visualización en una pantalla de televisión.
- 27. Botón de MENU** Visualiza los menús DVD.
- 28. Botón de avance (FWD)**
Hace que la reproducción avance rápidamente hasta un punto deseado.
- 29. Botones numéricos**
- 30. Botón del ZOOM**
Amplia parte de una imagen de DVD reproducida.

VISTA TRASERA

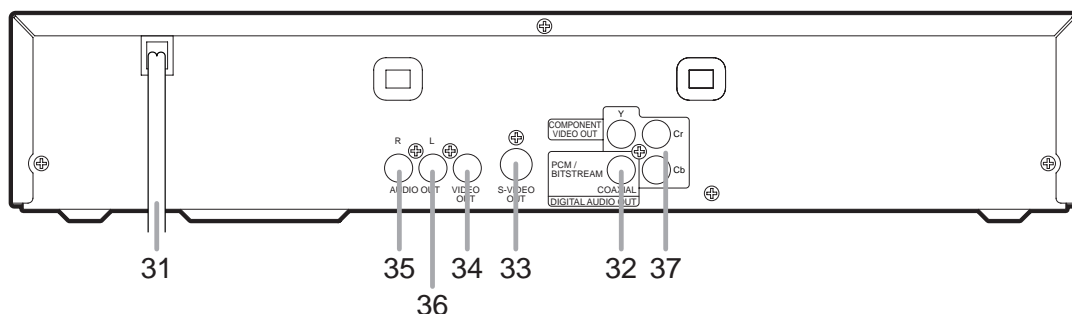

31. Cable de alimentación
 32. Toma de salida de audio digital coaxial (COAXIAL DIGITAL AUDIO OUT)
 33. Toma de salida de vídeo S (S-VIDEO OUT)
 34. Toma de salida de vídeo (VIDEO OUT)
 35. Toma de salida de audio derecha (AUDIO OUT)
 36. Toma de salida de audio izquierda (AUDIO OUT)
 37. Tomas de salida de video componentes

VISUALIZACIÓN

Permanece encendido cuando está activada la función de repetición A-B.

Permanece encendido cuando está activada la función de repetición.

Se enciende cuando se inserta un DVD en la bandeja.

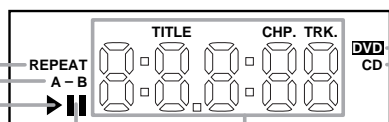

Se enciende cuando el disco insertado hace una pausa.

Se enciende cuando se inserta un CD en la bandeja.

Permanece encendido cuando el disco insertado está siendo reproducido.

Visualiza el tiempo de reproducción del título o de la pista actual.
 Cuando se cambia un capítulo o una pista, se visualiza el número del nuevo título, capítulo o pista. (en el modo de búsqueda o cuando se pulsa el botón de salto ascendente/descendente).

VISUALIZACIONES DURANTE LA OPERACIÓN

	Conexión de alimentación
	No hay disco insertado
	Bandeja abierta
	Bandeja cerrada
	Carga del disco
	Desconexión de alimentación

INSTALACIÓN DE LAS PILAS

1. Abra la tapa del compartimiento de las pilas.
2. Introduzca dos pilas AA con las polaridades colocadas correctamente.
3. Cierre la tapa.

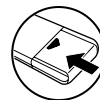
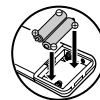
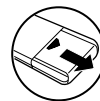

Notas

- No mezcle pilas alcalinas y de manganeso.
- No mezcle pilas viejas y nuevas.

CONEXIONES

CONEXIÓN A UN TELEVISOR

Consulte la figura 1 de la página 10

PARA TELEVISORES CON TOMA DE ENTRADA DE VÍDEO S

Utilice un cable de vídeo S (de venta en el comercio) en lugar del cable de vídeo amarillo para disfrutar de imágenes de más alta calidad.

Consulte la figura 2 de la página 10

Consulte la figura 3 de la página 10

CONEXIÓN A UN AMPLIFICADOR EQUIPADO CON TOMAS DE ENTRADA DIGITAL, PLATINA MD O PLATINA DAT

Para hacer las conexiones de audio utilice cables digitales coaxiales de audio (de venta en el comercio).

Consulte la figura 4 de la página 11

CONEXIÓN A UN DESCODIFICADOR DOLBY DIGITAL O A UN DESCODIFICADOR DTS

Si utiliza este reproductor DVD para reproducir un DVD en un formato de sonido ambiental DTS o sonido ambiental Dolby Digital de 5,1 canales, el reproductor DVD dará salida a un flujo de datos Dolby Digital o DTS desde su toma COAXIAL DIGITAL AUDIO OUT. Conectando el reproductor a un decodificador Dolby Digital o DTS, usted podrá disfrutar de un ambiente más convincente y real, con un sonido ambiental potente y de alta calidad de estándar profesional como el que puede oírse en los cines.

Para hacer las conexiones de audio utilice cables digitales coaxiales de audio (de venta en el comercio).

Consulte la figura 4 de la página 11

CONEXIÓN A UN TELEVISOR O A UN TELEVISOR ESTÉREO QUE TENGA TOMAS COMPONENT VIDEO IN

Ponga Dolby Digital y DTS en OFF en el reproductor DVD. Si reproduce un DVD cuando los ajustes están mal hechos, el sonido se distorsionará o usted tal vez estropee los altavoces.

Consulte la figura 5 de la página 11

REPRODUCCIÓN DE UN DISCO

REPRODUCCIÓN DE UN DVD DE VÍDEO O UN CD DE AUDIO

DVD

CD

Para empezar

Conecte la alimentación del televisor, amplificador y cualquier otro componente que esté conectado al reproductor DVD. (Cambie el sistema de entrada para adaptarlo al reproductor DVD, y compruebe que el volumen del sonido sea correcto.)

1 Pulse el botón POWER.

- La alimentación se conectará.

2 Pulse el botón OPEN/CLOSE.

- La bandeja de carga del disco se abrirá.

3 Ponga un disco en la bandeja.

- Asegúrese de que el disco esté correctamente asentado en el hueco correcto, con el lado de la etiqueta hacia arriba.

4 Pulse el botón PLAY.

- La bandeja se cerrará automáticamente y la reproducción empezará desde el primer capítulo o pista del disco. Necesitará pulsar el botón PLAY sólo cuando la bandeja haya sido cerrada pulsando el botón OPEN/CLOSE.
- Cuando reproduzca un DVD que tenga grabado un menú de títulos, el menú tal vez aparezca en la pantalla. En este caso, consulte "UTILIZACIÓN DEL MENÚ DE TÍTULOS".

5 Pulse el botón STOP para detener la reproducción.

SYLVANIA

LIMITED WARRANTY

Funai Corporation will exchange or repair this product, at its option, in the event of defect in materials or workmanship as follows:

EXCHANGE DURATION:

1-90 DAYS: FUNAI CORPORATION will exchange for a new unit without charge for a period of ninety (90) days from the date of original retail purchase.

91-365 DAYS: FUNAI CORPORATION will exchange for a factory-service-to-new-condition unit for a charge of \$49.00 for the period of ninety one (91) days to three hundred sixty five (365) days from the date of original retail purchase.

REPAIR DURATION:

LABOR: FUNAI CORPORATION will provide the labor without charge for a period of ninety (90) days from the date of original retail purchase.

PARTS: FUNAI CORPORATION will provide parts to replace defective parts without charge for a period of one (1) year from the date of original retail purchase. Certain parts are excluded from this warranty.

LIMITS AND EXCLUSIONS:

This warranty is extended only to the original retail purchaser. A purchase receipt or other proof of original retail purchase will be required together with the product to obtain exchange or service under this warranty.

This warranty shall not be extended to any other person or transferee.

This warranty is void and of no effect if any serial numbers on the product are altered, replaced, defaced or missing. This SYLVANIA Limited warranty applies only to product purchased and used in the United States.

This warranty only covers failures due to defects in material or workmanship, which occur during normal use. It does not cover damage which occurs in shipment, or failures which are caused by repairs, alterations, or parts not supplied by FUNAI CORPORATION, or damage which results from accident, misuse, abuse, mishandling, misapplication, alteration, faulty installation, improper maintenance, commercial use such as hotel, rental or office use of this product, or damage which results from fire, flood, lightning or other acts of God.

THIS WARRANTY DOES NOT COVER PACKING MATERIALS, ANY ACCESSORIES (EXCEPT REMOTE CONTROL UNITS), ANY COSMETIC PARTS, COMPLETE ASSEMBLY PARTS, DEMONSTRATION OR FLOOR MODELS.

FUNAI CORPORATION AND ITS REPRESENTATIVES OR AGENTS SHALL IN NO EVENT BE LIABLE FOR ANY GENERAL, INDIRECT OR CONSEQUENTIAL DAMAGES ARISING OUT OF OR OCCASIONED BY THE USE OF OR THE INABILITY TO USE THIS PRODUCT. THIS WARRANTY IS MADE IN LIEU OF ALL OTHER WARRANTIES INCLUDING THE WARRANTY OF MERCHANT ABILITY, AND FITNESS FOR A PARTICULAR PURPOSE, THAT ARE HEREBY DISCLAIMED BY FUNAI CORPORATION AND ITS REPRESENTATIVES OR AGENTS IN THE UNITED STATES.

ALL WARRANTY INSPECTIONS AND REPAIRS MUST BE PERFORMED BY A FUNAI AUTHORIZED CENTER. THIS WARRANTY IS VALID WHEN THE PRODUCT IS DELIVERED PREPAID TO A FUNAI AUTHORIZED SERVICE FACILITY.

PRIOR TO RETURNING THIS PRODUCT TO THE FACTORY SERVICE CENTER FOR REPAIR, CONTACT THE FUNAI SERVICE DEPARTMENT TO RECEIVE A RETURN FOR REPAIR AUTHORIZATION. ANY POSTAGE, INSURANCE, AND SHIPPING COSTS INCURRED IN PRESENTING PRODUCT FOR REPAIR ARE THE SHIPPER'S RESPONSIBILITIES.

CAREFULLY PACK WITH PROPER PACKING MATERIALS, PREFERABLY IN THE ORIGINAL CARTON OR PACKING MATERIALS AND CARTON OBTAINED FROM FUNAI CORPORATION.

ENCLOSE WRITTEN DOCUMENTATION DETAILING THE COMPLAINT. PLACE INSIDE THE CARTON OR IN A PACKING SLIP ENVELOPE ON THE OUTSIDE OF THE CARTON.

A COPY OF THE ORIGINAL RETAIL PURCHASE RECEIPT MUST ACCOMPANY THE PRODUCT. IF NO PROOF OF PURCHASE IS INCLUDED, THE WARRANTY WILL NOT BE HONORED.

IMPORTANT:

THIS LIMITED WARRANTY GIVES YOU SPECIFIC LEGAL RIGHTS, YOU MAY HAVE OTHER RIGHTS THAT VARY FROM STATE TO STATE, IF AT ANY TIME DURING THE WARRANTY PERIOD YOU ARE UNABLE TO OBTAIN SATISFACTION WITH THE EXCHANGE OR REPAIR OF THIS PRODUCT, PLEASE CONTACT FUNAI CORPORATION.

ATTENTION:

FUNAI CORPORATION RESERVES THE RIGHT TO MODIFY ANY DESIGN OF THIS PRODUCT WITHOUT PRIOR NOTICE. For information about your product, or for information on how to exchange or repair your product, telephone or write to the following:

FUNAI CORPORATION, INC.

Customer Service

100 North Street; Teterboro, NJ 07608

Telephone (800)968-3429

PLEASE DO NOT SHIP YOUR UNIT TO TETERBORO ADDRESS.

Free Manuals Download Website

<http://myh66.com>

<http://usermanuals.us>

<http://www.somanuals.com>

<http://www.4manuals.cc>

<http://www.manual-lib.com>

<http://www.404manual.com>

<http://www.luxmanual.com>

<http://aubethermostatmanual.com>

Golf course search by state

<http://golfingnear.com>

Email search by domain

<http://emailbydomain.com>

Auto manuals search

<http://auto.somanuals.com>

TV manuals search

<http://tv.somanuals.com>