

Owner's Manual

DVD Recorder

DVR90DG

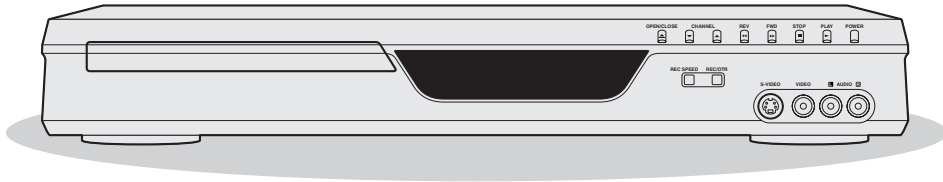

INSTRUCCIONES EN ESPAÑOL INCLUIDAS

Please read before using this equipment.
If you need additional operating assistance after reading this owner's manual or to order replacement accessories, please call

TOLL FREE : 1-800-605-8453

or visit our web site at <http://www.SylvaniaConsumerElectronics.com>

Connection to a TV (Before you use this unit, you need to complete connections.)

If your TV has AUDIO/VIDEO input jacks, see the section "Connections" on pages 13–15. If not, it is still possible to connect this unit to your TV by using a Stereo Audio/Video RF modulator. In this case, follow the instructions below.

- 1) The antenna input jack of your TV may have been already occupied. If so, disconnect the RF cable from your TV, and then connect the RF cable to the ANTENNA IN jack of this unit.
 - 2) Connect the ANTENNA OUT jack of this unit to your RF modulator (usually marked "ANT IN") by the RF cable.
 - 3) Connect your RF modulator to your TV by another RF cable.
 - 4) Connect the AUDIO/VIDEO output jacks of this unit to the AUDIO/VIDEO input jacks of your RF modulator by Audio/Video cables.
 - 5) Set your RF modulator's channel 3/4 switch to either 3 or 4, whichever the TV channel is least used in your area. If your RF modulator has a Modulator/Antenna switch, set it according to your RF modulator's manual.
 - 6) Turn on your TV and choose the same channel as you set the RF modulator's channel 3/4 switch to.
- For more details, follow the instructions supplied with the RF modulator.

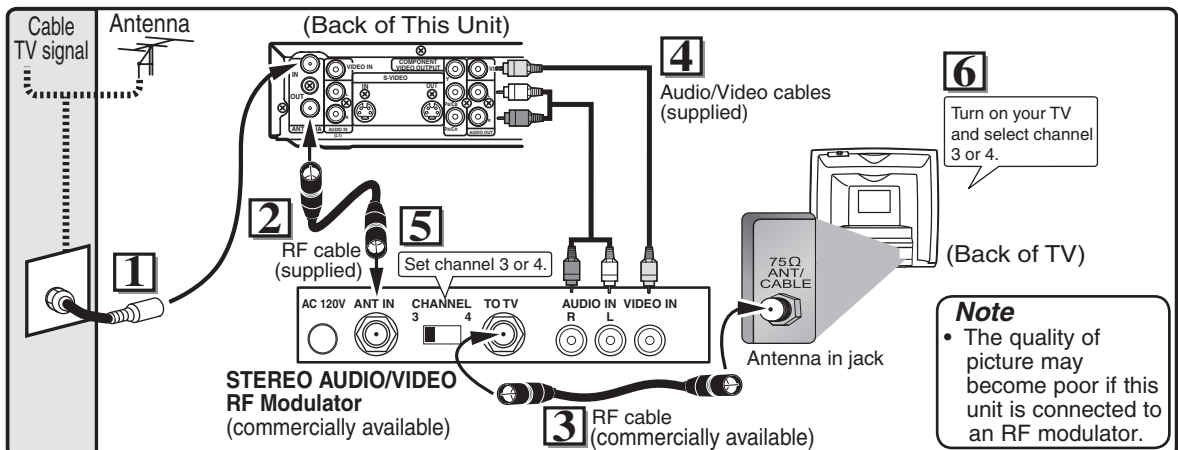

To record a program easily, refer to "Easy DVD recording" on pages 16-17 after connections are completed.

(You CANNOT record on any copyright protected DVD discs with this unit.)

Before you start

Precautions

WARNING: TO REDUCE THE RISK OF FIRE OR ELECTRIC SHOCK, DO NOT EXPOSE THIS APPLIANCE TO RAIN OR MOISTURE.



CAUTION
RISK OF ELECTRIC SHOCK
DO NOT OPEN



CAUTION:

TO REDUCE THE RISK OF ELECTRIC SHOCK, DO NOT REMOVE COVER (OR BACK). NO USER SERVICEABLE PARTS INSIDE. REFER SERVICING TO QUALIFIED SERVICE PERSONNEL.



The lightning flash with arrowhead symbol, within an equilateral triangle, is intended to alert the user to the presence of uninsulated "dangerous voltage" within the product's enclosure that may be of sufficient magnitude to constitute a risk of electric shock to persons.



The exclamation point within an equilateral triangle is intended to alert the user to the presence of important operating and maintenance (servicing) instructions in the literature accompanying the appliance.

Laser Safety

This unit employs a laser. Only a qualified service person should remove the cover or attempt to service this device, due to possible eye injury.

CAUTION: USE OF CONTROLS OR ADJUSTMENTS OR PERFORMANCE OF PROCEDURES OTHER THAN THOSE SPECIFIED HEREIN MAY RESULT IN HAZARDOUS RADIATION EXPOSURE.

CAUTION: VISIBLE AND INVISIBLE LASER RADIATION WHEN OPEN AND INTERLOCK DEFEATED. DO NOT STARE INTO BEAM.

LOCATION: INSIDE, NEAR THE DECK MECHANISM.

FCC WARNING- This equipment may generate or use radio frequency energy. Changes or modifications to this equipment may cause harmful interference unless the modifications are expressly approved in the manual. The user could lose the authority to operate this equipment if an unauthorized change or modification is made.

RADIO-TV INTERFERENCE

This equipment has been tested and found to comply with the limits for a Class B digital device, pursuant to Part 15 of the FCC Rules. These limits are designed to provide reasonable protection against harmful interference in a residential installation. This equipment generates, uses, and can radiate radio frequency energy and, if not installed and used in accordance with the instructions, may cause harmful interference to radio communications. However, there is no guarantee that interference will not occur in a particular installation. If this equipment does cause harmful interference to radio or television reception, which can be determined by turning the equipment off and on, the user is encouraged to try to correct the interference by one or more of the following measures:

- 1) Reorient or relocate the receiving antenna.
- 2) Increase the separation between the equipment and receiver.
- 3) Connect the equipment into an outlet on a circuit different from that to which the receiver is connected.
- 4) Consult the dealer or an experienced radio/TV technician for help.

This Class B digital apparatus complies with Canadian ICES-003.

Cet appareil numérique de la classe B est conforme à la norme NMB-003 du Canada.

CAUTION: TO PREVENT ELECTRIC SHOCK, MATCH WIDE BLADE OF PLUG TO WIDE SLOT, FULLY INSERT.

ATTENTION:POUR ÉVITER LES CHOC ÉLECTRIQUES, INTRODUIRE LA LAME LA PLUS LARGE DE LA FICHE DANS LA BORNE CORRESPONDANTE DE LA PRISE ET POUSSER JUSQU'AU FOND.

A NOTE ABOUT RECYCLING

This product's packaging materials are recyclable and can be reused. Please dispose of any materials in accordance with your local recycling regulations.

Batteries should never be thrown away or incinerated but disposed of in accordance with your local regulations concerning chemical wastes.

Make your contribution to the environment!!!

- Used up batteries do not belong in the dust bin.
- You can dispose of them at a collection point for used up batteries or special waste. Contact your council for details.



For Customer Use:

Read carefully the information located at the back of this unit and enter below the Model No. and Serial No. Retain this information for future reference.

Model No. _____

Serial No. _____

IMPORTANT SAFEGUARDS

1. Read Instructions - All the safety and operating instructions should be read before the appliance is operated.
2. Retain Instructions- The safety and operating instructions should be retained for future reference.
3. Heed Warnings - All warnings on the appliance and in the operating instructions should be adhered to.
4. Follow Instructions - All operating and use instructions should be followed.
5. Cleaning - Unplug this product from the wall outlet before cleaning. Do not use liquid cleaners or aerosol cleaners. Use a damp cloth for cleaning.

EXCEPTION: A product that is meant for uninterrupted service and, that for some specific reason, such as the possibility of the loss of an authorization code for a CATV converter, is not intended to be unplugged by the user for cleaning or any other purpose, may exclude the reference to unplugging the appliance in the cleaning description otherwise required in item 5.

6. Attachments - Do not use attachments not recommended by the product manufacturer as they may cause hazards.
7. Water and Moisture- Do not use this product near water, for example, near a bath tub, wash bowl, kitchen sink, or laundry tub, in a wet basement, or near a swimming pool, and the like.
8. Accessories - Do not place this product on an unstable cart, stand, tripod, bracket, or table. The product may fall, causing serious injury to a child or adult, and serious damage to the appliance. Use only with a cart, stand, tripod, bracket, or table recommended by the manufacturer, or sold with the product. Any mounting of the appliance should follow the manufacturer's instructions and should use a mounting accessory recommended by the manufacturer. An appliance and cart combination should be moved with care. Quick stops, excessive force, and uneven surfaces may cause the appliance and cart combination to overturn.
9. Ventilation - Slots and openings in the cabinet are provided for ventilation and to ensure reliable operation of the product and to protect it from overheating, and these openings must not be blocked or covered. The openings should never be blocked by placing the product on a bed, sofa, rug, or other similar surface. This product should not be placed in a built-in installation such as a bookcase or rack unless proper ventilation is provided or the manufacturer's instructions have been adhered to.
10. Power Sources - This product should be operated only from the type of power source indicated on the marking label. If you are not sure of the type of power supply to your home, consult your appliance dealer or local power company. For products intended to operate from battery power, or other sources, refer to the operating instructions.

PORTABLE CART WARNING
(Symbol provided by RETAC)



11. Grounding or Polarization - This product is equipped with a polarized alternating-current line plug (a plug having one blade wider than the other). This plug will fit into the power outlet only one way. This is a safety feature. If you are unable to insert the plug fully into the outlet, try reversing the plug. If the plug should still fail to fit, contact your electrician to replace your obsolete outlet. Do not defeat the safety purpose of the polarized plug.
12. Power Cord Protection - Power supply cords should be routed so that they are not likely to be walked on or pinched by items placed upon or against them, paying particular attention to cords at plugs, convenience receptacles, and the point where they exit from the appliance.
13. Outdoor Antenna Grounding - If an outside antenna or cable system is connected to the product, be sure the antenna or cable system is grounded so as to provide some protection against voltage surges and built-up static charges. Article 810 of the National Electrical Code, ANSI/

NFPA No. 70, provides information with regard to proper grounding of the mast and supporting structure, grounding of the lead-in wire to an antenna discharge unit, size of grounding conductors, location of antenna-discharge unit, connection to grounding electrodes, and requirements for the grounding electrode. (Fig. A)

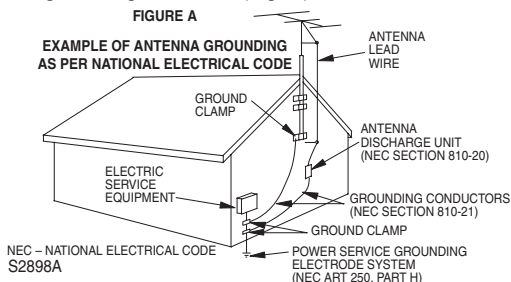

14. Lightning - For added protection for this product during a lightning storm, or when it is left unattended and unused for long periods of time, unplug it from the wall outlet and disconnect the antenna or cable system. This will prevent damage to the product due to lightning and power-line surges.
15. Power Lines - An outside antenna system should not be located in the vicinity of overhead power lines or other electric light or power circuits, or where it can fall into such power lines or circuits. When installing an outside antenna system, extreme care should be taken to keep from touching such power lines or circuits as contact with them might be fatal.
16. Overloading - Do not overload wall outlets and extension cords as this can result in a risk of fire or electric shock.
17. Object and Liquid Entry - Never push objects of any kind into this product through any openings as they may touch dangerous voltage points or short-out parts that could result in a fire or electric shock. Never spill liquid of any kind on the product.
18. Servicing - Do not attempt to service this product yourself as opening or removing covers may expose you to dangerous voltage or other hazards. Refer all servicing to qualified service personnel.
19. Damage Requiring Service - Unplug this product from the wall outlet and refer servicing to qualified service personnel under the following conditions:
 - a. When the power-supply cord or plug is damaged,
 - b. If liquid has been spilled, or objects have fallen into the product,
 - c. If the product has been exposed to rain or water,
 - d. If the product does not operate normally by following the operating instructions. Adjust only those controls that are covered by the operating instructions as an improper adjustment of other controls may result in damage and will often require extensive work by a qualified technician to restore the product to its normal operation,
 - e. If the product has been dropped or damaged in any way, and
 - f. When the product exhibits a distinct change in performance this indicates a need for service.
20. Replacement Parts - When replacement parts are required, be sure the service technician has used replacement parts specified by the manufacturer or have the same characteristics as the original part. Unauthorized substitutions may result in fire, electric shock or other hazards.
21. Safety Check - Upon completion of any service or repairs to this product, ask the service technician to perform safety checks to determine that the product is in proper operating condition.
22. Heat - This product should be situated away from heat sources such as radiators, heat registers, stoves, or other products (including amplifiers) that produce heat.

Before you start

Precautions (cont'd)

Installation Location

For safety and optimum performance of this unit:

- Install the unit in a horizontal and stable position. Do not place anything directly on top of the unit. Do not place the unit directly on top of the TV.
- Shield it from direct sunlight and keep it away from sources of intense heat. Avoid dusty or humid places. Avoid places with insufficient ventilation for proper heat dissipation. Do not block the ventilation holes on the sides of the unit. Avoid locations subject to strong vibration or strong magnetic fields.

Avoid the Hazards of Electrical Shock and Fire

- Do not handle the power cord with wet hands.
- Do not pull on the power cord when disconnecting it from AC wall outlet. Grasp it by the plug.
- If, by accident, water is spilled on this unit, unplug the power cord immediately and take the unit to our Authorized Service Center for servicing.

Moisture Condensation Warning

Moisture condensation may occur inside the unit when it is moved from a cold place to a warm place or after heating a cold room or under conditions of high humidity. Do not use this unit at least for 2 hours until its inside gets dry.

About Copyright

Unauthorized copying, broadcasting, public performance and lending of discs are prohibited. This product incorporates copyright protection technology that is protected by U.S. patents and other intellectual property rights. Use of this copyright protection technology must be authorized by Macrovision, and is intended for home and other limited viewing uses only unless otherwise authorized by Macrovision. Reverse engineering or disassembly is prohibited.

Notice for progressive scan output

Consumers should note that not all high definition television sets are fully compatible with this product and may cause artifacts to be displayed in the picture. In case of picture problems with 525 progressive scan output, it is recommended that the user switch the connection to the 'standard definition' output. If there are questions regarding your TV set compatibility with this 525p DVD recorder, please contact our customer service center.

Supplied Accessory

- Remote control (NB075UD) with two AA batteries
- RF cable (WPZ0901CAB01 or WPZ0901TM002)
- Audio/Video cables (WPZ0102TM015 or WPZ0102LTE01)
- Owner's Manual (1VMN21672)
- Quick Use Guide (1VMN21673)

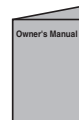
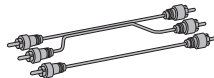

Before you start

Precautions (cont'd)

Maintenance

SERVICING

- Please refer to relevant topics on “Troubleshooting” on pages 72-75 before returning the product.
- If this unit becomes inoperative, do not try to correct the problem by yourself. There are no user-serviceable parts inside. Turn off, unplug the power plug and please call our help line mentioned on the front page to locate an Authorized Service Center.

CLEANING THE CABINET

- Use a soft cloth slightly moistened with a mild detergent solution. Do not use a solution containing alcohol, spirits, ammonia or abrasive.

CLEANING DISCS

- When a disc becomes dirty, clean it with a cleaning cloth. Wipe the disc from the center to out. Do not wipe in a circular motion.
- Do not use solvents such as benzine, thinner, commercially available cleaners, detergent, abrasive cleaning agents or antistatic spray intended for analogue records.

CLEANING THE DISC LENS

- If this unit still does not perform properly although you refer to the relevant sections and to “Troubleshooting” in this Owner’s Manual, the laser optical pickup unit may be dirty. Consult your dealer or an Authorized Service Center for inspection and cleaning of the laser optical pickup unit.

DISC HANDLING

- Handle the discs so that fingerprints and dust do not adhere to the surfaces of the discs.
- Always store the disc in its protective case when it is not used.

Manufactured under license from Dolby Laboratories. “Dolby” and the double-D symbol are trademarks of Dolby Laboratories.

Dolby Digital Recording

“Dolby® Digital Recording enables consumers to record high-quality video with stereo sound on recordable DVD discs. The technology, when utilized instead of PCM recording, also saves recordable disc space, allowing for higher video resolution or extended recording time on each DVD. DVDs created using Dolby Digital Recording will play back on all DVD-Video players.”

Note: This is true when the players are compatible with actual recordable DVD discs.

Before you start

Table of contents

Before you start	2	Fast forward / Fast reverse	41
Precautions	2	Skipping TV commercials during play	41
Table of contents	6	Rapid Play	42
Features	7	Step by step playback	42
Symbol in this Owner's Manual	7	Slow forward / Slow reverse play	42
Functional overview	8	Zoom	43
Installing batteries in the remote control	10	Marker Setup	43
Using a remote control	10	Search	44
Display menu	10	Title/Chapter search	44
Setup menus	11	Track search	45
Connections	13	Time search	45
Connection to a TV	13	Repeat/Random/Program playback	46
Connection to a cable box or satellite box	14	Repeat play	46
Connection to an Audio System	15	Random playback	46
Getting started	16	Program play	47
Easy DVD recording	16	Selecting the format of audio and video	47
Initial setting	18	Switching subtitles	47
Channel setting	18	Switching audio soundtrack	48
Getting channels automatically	18	Switching virtual surround system	48
Adding/deleting channels	19	Switching camera angles	49
Selecting the TV stereo or SAP	20	Reducing block noise	49
Setting the clock	21	Editing	50
Auto Clock Setting	21	Information on disc editing	50
Manual Clock Setting	22	Guide to a title list	50
Setting the Daylight Saving Time	23	Editing discs in Video mode	50
Selecting the TV aspect ratio	23	Editing discs in VR mode	50
Recording	24	Editing discs in Video mode	51
Information on DVD recording	24	Deleting titles	51
Information	24	Putting names on titles	52
Recordable disc	24	Setting or clearing chapter markers	53
Recording speed	24	Editing discs in VR mode (Original)	54
Restrictions on recording	25	Deleting titles	54
Information on copy control	25	Setting titles to protect	55
Making discs playable in other DVD player (Finalize)	25	Releasing titles from protecting	56
Formatting a disc	26	Editing discs in VR mode (Playlist)	57
Choosing the recording format of a blank disc	26	Deleting titles	57
Reformatting a disc	27	Dividing a title	58
Setting for Auto Chapter	27	Combining titles	59
Basic recording	28	Adding titles to a Playlist	60
One-touch Timer Recording	29	Deleting a Playlist	60
Timer Recording	30	Editing discs in VR mode (Original / Playlist)	61
Hints for Timer Recording	32	Deleting parts of titles	61
Settings for an external source	33	Putting names on titles	62
Connection to an external source	33	Setting or clearing chapter markers	63
Recording from an external source	34	Setting pictures for thumbnails	64
Setting a disc to protect	34	Changing the Setup menu	65
Finalizing the discs	35	Tour of the Setup menu	65
Auto finalize	36	Language setting	66
Playing discs	37	Display setting	67
Information on DVD play	37	Audio setting	68
Guide to displays	37	Settings for Parental lock level	70
Basic playback	38	Others	72
Playback	38	Troubleshooting	72
Playing MP3 disc	39	Language code	75
Playing discs using the Disc menu	40	Glossary	76
Playing discs using the Title menu	40	Frequently Asked Questions	76
Pause	40	Specifications	77
Special playback	41	Español	78
Resume play	41		

Before you start

Features

This DVD unit not only plays DVDs and CDs but also offers features for you to record to DVD discs and edit them after that.

The following features are offered with this unit.

Recording

This unit is compatible with both DVD-RW, which is rewritable repeatedly and DVD-R, which is available for recording once. You can choose either one for your convenience.

Up to 8 program recording:

You can program the unit to record up to 8 programs, with in a month in advance. Daily or weekly program recordings are also available.

One-touch Timer Recording:

You can easily set a recording time as you prefer. Every time [REC/OTR] is pressed during recording, the recording time will be increased by 30 minutes up to 8 hours. The recording automatically stops when the recording time you set is reached.

Automatic Chapter marker setting:

Chapter markers will be put on recordings as you set in the Setup menu before attempting to record.

Automatic Title menu making:

The unit makes title menus automatically when finalizing the disc which are recorded in Video mode.

Automatic Playlist making (VR mode):

A Playlist will be prepared from an Original title, so that you can edit titles in a Playlist as you prefer. An Original title is kept as it is.

Automatic finalizing (Video mode):

You can finalize discs after finishing all Timer Recordings and at the end of the disc space automatically as you set in the Setup menu.

Left channel stereo recording:

This unit can record the sound of the Left channel monaural input as Left and Right channels automatically (the input from the LINE 2 only).

Play

Theater surround sound in your home:

When connecting the unit to an amplifier or a decoder which is compatible with Dolby Digital, you are allowed to experience the theater surround sound from discs with surround sound system.

Quick search for what you want to watch:

You can easily find the part you want to watch using the search function. Search for a desired point on a disc by title, chapter or time.

Start to play from Original and Playlist:

Title playing is available from either an Original title or Playlist.

Virtual Surround System:

You can enjoy stereophonic space through your exciting 2 channel stereo system.

Playing back on MP3 disc:

You can enjoy MP3 files which are recorded on CD-R/RW.

Editing

Deleting titles:

You can delete titles which you do not need anymore.

Making your own Playlist:

With the original remains as it is, you can edit titles on various Playlist as you prefer.

Putting names on titles

Setting pictures for thumbnails

Setting / clearing chapter markers

Dividing / combining titles

Deleting parts of titles, etc.

Protecting titles:

To avoid editing or erasing titles, the protect function is useful when it is ON in the Original titles.

Compatibility

Available for playing discs recorded in Video mode on a regular DVD player (Video mode):

Discs recorded in Video mode can be played on regular DVD players, including computer DVD drives compatible with DVD-Video playback*. You will need to finalize the discs recorded in Video mode to play in other DVD players.

** DVD-Video Format (Video mode) is a new format for recording on DVD-RW/R discs that was approved by the DVD Forum in 2000. Adoption of this format is optional for manufactures of DVD playback devices and there are DVD-Video players, DVD-ROM drives or other DVD playback devices that do not play DVD-RW/R discs recorded in the DVD-Video Format.*

Others







Progressive Scan system

Unlike conventional interlace scanning, the progressive scan system provides less flickering and images in higher resolution than that of traditional television signals.

Symbol in this Owner's Manual

Many functions of this unit are depending on the disc type or the recording mode.

To specify for what disc type or recording mode each function is, we put the following symbols at the beginning of each item to operate.

Symbol	Description
	Available to DVD-Video discs
	Available to DVD-RW in Video mode
	Available to DVD-RW in VR mode
	Available to DVD-R discs
	Available to Audio CDs
	Available to CD-RW/R discs with MP3 files

Before you start

Functional overview

Front Panel

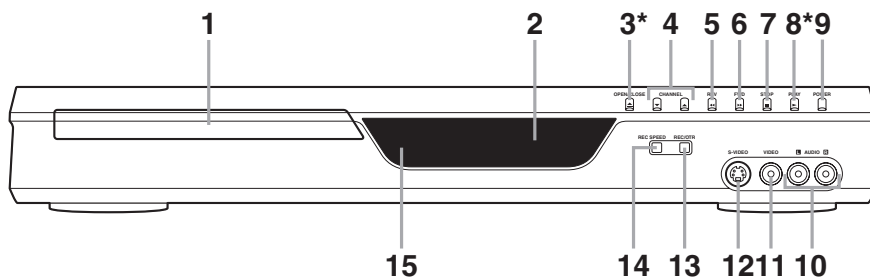

(* The unit can also be turned on by pressing these buttons.

1. **Disc tray**
Place a disc when open.
2. **Display**
Refer to "Front Panel Display Guide" on page 12.
3. **OPEN/CLOSE ▲ button***
Press to open or close the disc tray.
4. **CHANNEL ▼ / ▲ button**
Press to change the channel up and down.
5. **REV ◀◀ button**
During playback, press to skip to the previous chapter or track.
During playback, press and hold for 1.5 seconds to fast reverse.
When playback is paused, press repeatedly to slow reverse.
6. **FWD ▶▶ button**
During playback, press to skip to the next chapter or track.
During playback, press and hold for 1.5 seconds to fast forward.
When playback is paused, press repeatedly to slow forward.
7. **STOP ■ button**
Press to stop play or recording.
8. **PLAY ▶ button***
Press to start or resume play.
9. **POWER button**
Press to turn the unit on and off.
If timer programmings have been set, press to set the unit in timer-standby mode.
10. **AUDIO input jacks (LINE2)**
Use to connect external equipment with standard audio cable.
11. **VIDEO input jack (LINE2)**
Use to connect external equipment with a standard video cable.
12. **S-VIDEO input jack (LINE2)**
Use to connect the S-Video output of external equipment with an S-Video cable.
13. **REC/OTR button**
Press once to start a recording. Press repeatedly to start a One-touch Timer Recording.
14. **REC SPEED button**
Press to switch the recording speed.
15. **Remote control sensor**
Receive signals from your remote control so that you can control the unit from a distance.

Rear Panel

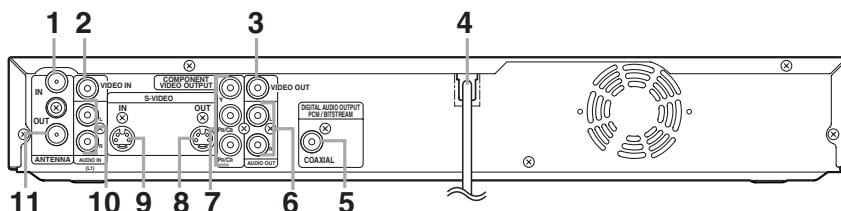

1. **ANTENNA IN jack**
Use to connect an antenna.
2. **VIDEO IN jack (LINE1)**
Use to connect external equipment with a standard video cable.
3. **VIDEO OUT jack**
Use to connect a TV monitor, AV receiver or other equipment with a standard video cable.
4. **AC Power Cord**
Connect to a standard AC outlet to supply power to this unit.
5. **COAXIAL DIGITAL AUDIO OUTPUT jack**
Use to connect an AV receiver, Dolby Digital decoder or other equipment with a coaxial digital input jack with a digital coaxial cable.
6. **AUDIO OUT jacks**
Use to connect a TV monitor, AV receiver or other equipment with standard audio cable.
7. **COMPONENT VIDEO OUTPUT jacks**
Use to connect a TV monitor with component video inputs with component video cables.
8. **S-VIDEO OUT jack**
Use to connect the S-Video input of a TV monitor, AV receiver or other equipment with an S-Video cable.
9. **S-VIDEO IN jack (LINE1)**
Use to connect the S-Video output of external equipment with an S-Video cable.
10. **AUDIO IN jacks (LINE1)**
Use to connect external equipment with standard audio cable.
11. **ANTENNA OUT jack**
Use to connect an antenna cable to pass the signal from the TV ANTENNA IN to your TV monitor.

Note

- Do not touch the inner pins of the jacks on the rear panel. Electrostatic discharge may cause permanent damage to the unit.
- This unit does not have the RF modulator.

Before you start

Functional overview (cont'd)

Remote Control

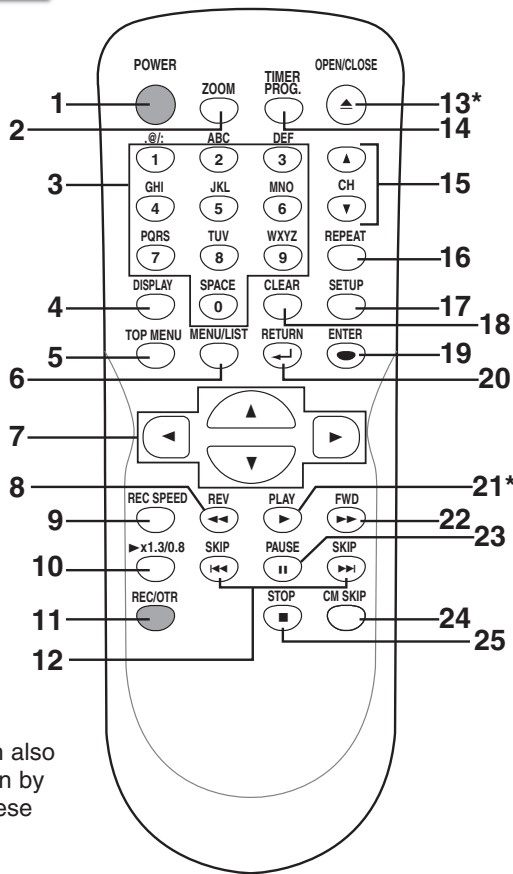

(*) The unit can also be turned on by pressing these buttons.

1. POWER button

Press to turn the unit on and off. If timer programmings have been set, press to set the unit in timer-standby mode.

2. ZOOM button

During playback, press to enlarge the picture on the screen.

3. Number buttons

Press to select channel numbers. Press to select a title/chapter/track on display. Or press to enter values for the settings in the Setup menu.

4. DISPLAY button

Press to display the On Screen menu on or off.

5. TOP MENU button

Press to display the Top menu.

6. MENU/LIST button

Press to display the Disc menu. To change Original and Playlist on the TV screen. (VR mode only)

7. Cursor ▲/▼/◀/▶ buttons

Press to select items or settings.

8. REV ◀◀ button

During playback, press to fast reverse. Or when playback is paused, press to play slow reverse.

9. REC SPEED button

Press to switch the recording speed.

10. ▶x1.3/0.8 button

During playback, press to playback in a slightly faster/slower speed with keeping the audio quality.

11. REC/OTR button

Press once to start a recording. Press repeatedly to start a One-Touch Timer Recording.

12. SKIP ◀◀ button

During playback, press to skip to the previous chapter or track. Or when playback is paused, press to play reverse step by step.

SKIP ▶▶ button

During playback, press to skip to the next chapter or track. Or when playback is paused, press to play forward step by step.

13. OPEN/CLOSE ▲ button*

Press to open or close the disc tray.

14. TIMER PROG. button

Press to display the Timer Programming list.

15. CH ▲/▼ buttons

Press to change the channel up and down.

16. REPEAT button

Press to display the Repeat menu.

17. SETUP button

Press to display the Setup menu.

During DVD playback, press and hold for more than 5 seconds to switch the progressive scanning mode to the interlace mode.

18. CLEAR button

Press to clear the password once entered or to cancel the programming for CD or to clear the selecting marker number in the marker setup mode or to clear the program once entered in the Timer Recording setting mode, etc.

19. ENTER button

Press to confirm or select menu items.

20. RETURN ◀ button

Press to return to the previously displayed menu screen.

21. PLAY ▶ button*

Press to start or resume play.

22. FWD ▶▶ button

During playback, press to play fast forward.

Or when playback is paused, press to play slow forward.

23. PAUSE || button

Press to pause play or recording.

24. CM SKIP button

During playback, press to skip 30 seconds.

25. STOP ■ button

Press to stop play or recording.

Before you start

Functional overview (cont'd)

Installing batteries in the remote control

Install two "AA" size batteries (supplied) matching the polarity indicated inside battery compartment of the remote control.

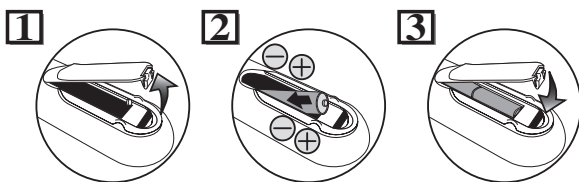

Note:

Incorrect use of batteries can result in hazards such as leakage and bursting. Please observe the following:

- Do not mix new and old batteries together.
- Do not use different kinds of batteries together, although they may look similar, different batteries may have different voltages.
- Make sure that the plus and minus ends of each battery match the indications in the battery compartment.
- Remove batteries from equipment that is not going to be used for a month or more.
- When disposing of used batteries, please comply with governmental regulations or environmental public instruction's rules that apply in your country or area.
- Do not recharge, short-circuit, heat, burn or disassemble batteries.

Using a remote control

Keep in mind the following when using the remote control:

- Make sure that there is no obstacle between the remote control and the remote sensor on the unit.
- Remote operation may become unreliable if strong sunlight or fluorescent light is shining on the remote sensor of the unit.
- Remote control for different devices can interfere with each other. Avoid using remote control for other equipment located close to the unit.
- Replace the batteries when you notice a fall off in the operating range of the remote control.
- The maximum operable ranges from the unit are as follows.
 - **Line of sight:** approx. 23 feet (7m)
 - **Either side of the center:** approx. 16 feet (5m) within 30°
 - **Above:** approx. 16 feet (5m) within 15°
 - **Below:** approx. 10 feet (3m) within 30°

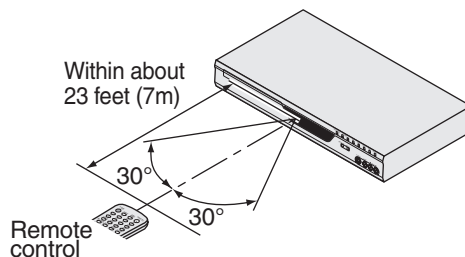

Guide to Displays the On Screen menu

This unit uses the following the On Screen menu for most operations: Setup menu, Title list, Playlist, Original and Display menu. They allow you to change the playing status of disc during play. The Display menu also gives you information on the status of the disc.

Display menu

Press **[DISPLAY]** to call up the Display menu. This menu will give you the information on the playing disc. Some operations are available while disc is playing.

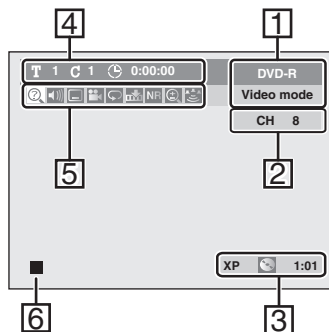

1. Indicates a disc type and a format mode.

NOTE: In some descriptions on this manual, only one disc type is indicated as an example.

2. Indicates a channel number.

3. Indicates a recording mode and possible recording time left.

4. Indicates a title number, chapter number and the time lapse of disc play.

5. Each icon means:

: Search

: Audio

: Subtitle

: Angle (except VR mode)

: Repeat

: Marker

: Noise Reduction

: Zoom

: Surround

6. Indicates current disc status.

Setup menus

Press **[SETUP]** to display the Setup menu, then press **[ENTER]** to display each menu, using **[▲ / ▼]**. These menus provide entries to all main functions of the unit.

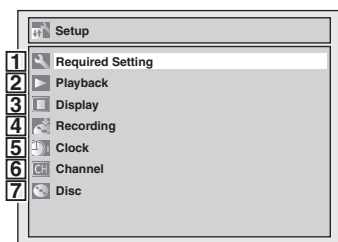

1. Required Setting:

To set up the required setting.

2. Playback:

To set up the unit to play discs as you prefer.

3. Display:

To set up the OSD screen and the front panel display of the unit as you prefer.

4. Recording:

To set up the unit to record to discs as you prefer.

5. Clock:

To set up the clock of the unit as you need.

6. Channel:

To adjust the channel setting of the unit as you prefer.

7. Disc / CD Playback Mode:

“Disc” is available only when a DVD-RW/R disc is inserted into the unit. When a DVD-Video disc (commercially available), a new DVD-R disc is inserted into the unit, you cannot select “Disc”.

“CD Playback Mode” is available only when an Audio CD disc or a CD-RW/R disc with MP3 files is inserted into the unit.

<DVD-R,DVD-RW (Video mode)>

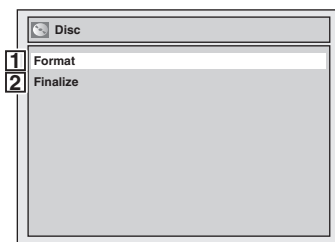

<DVD-RW (VR mode)>

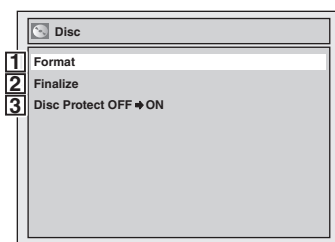

<CD, MP3>

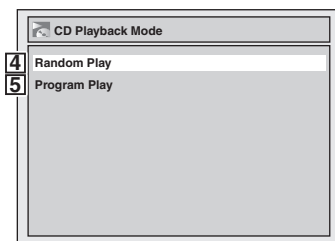

1. Format (DVD-RW only):

Allows you to erase all of the recorded content on the disc. The disc will be completely blank.

- Erased content cannot be called back.
- A DVD-RW disc formatted with this unit cannot be used in other DVD recorders without any recording using this unit.
- If you want to use a disc only formatted with this unit on another DVD recorder, you have to re-format the disc on that recorder.

2. Finalize:

Allows you to finalize a disc containing recorded titles.

3. Disc Protect (VR mode only):

Allows you to protect a disc from accidental editing or recording.

4. Random Play:

To activate the random playback feature.

5. Program Play (Audio CD only):

To activate the programmed playback feature.

Before you start

Functional overview (cont'd)

Front Panel Display Guide

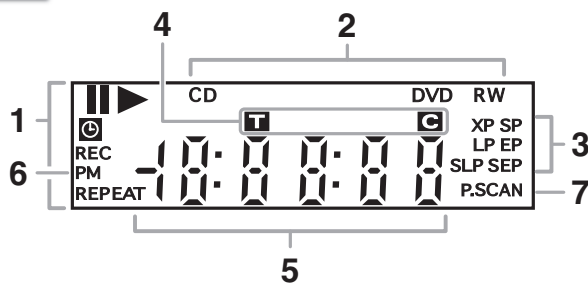

1. Current Status of the unit

- ||** :Appears when disc playback is paused.
- ▶** :Appears when playing a disc.
- ⌚** :Appears when the timer programming has been set and is proceeding. Flashes when all Timer Recordings have been finished, or when a program cannot be performed by some reason.
- REC** :Appears during recording process.
- REPEAT** :Appears during repeat play.

2. Disc type

- CD** :Appears when an Audio CD or a disc with MP3 files is inserted in the disc tray.
- DVD** :Appears when a DVD disc is inserted in the disc tray.
- DVD R** :Appears when a DVD-R disc is inserted in the disc tray.
- DVD RW** :Appears when a DVD-RW disc is inserted in the disc tray.

3. Recording speed

Indicates the recording speed of the disc.

4. Title / Track and Chapter mark

- T** :Appears when indicating a title/track number.
- C** :Appears when indicating a chapter number.

5. Displays the following

- Playing time
- Current title / chapter / track number
- Recording time/ remaining time
- Clock
- Channel number
- OTR (One-touch Timer Recording) remaining time

6. PM

:Appears in the afternoon with the clock displaying.

7. P.SCAN

:Appears when the progressive scan system is activated.

Display message



Appears when the unit is turned on.



Appears when the disc tray is closing.



Appears when the unit is turned off.



Appears when a disc is loaded on the disc tray.



Appears when the disc tray is opening.



Appears when data is being recorded on a disc.

Connections

Connection to a TV

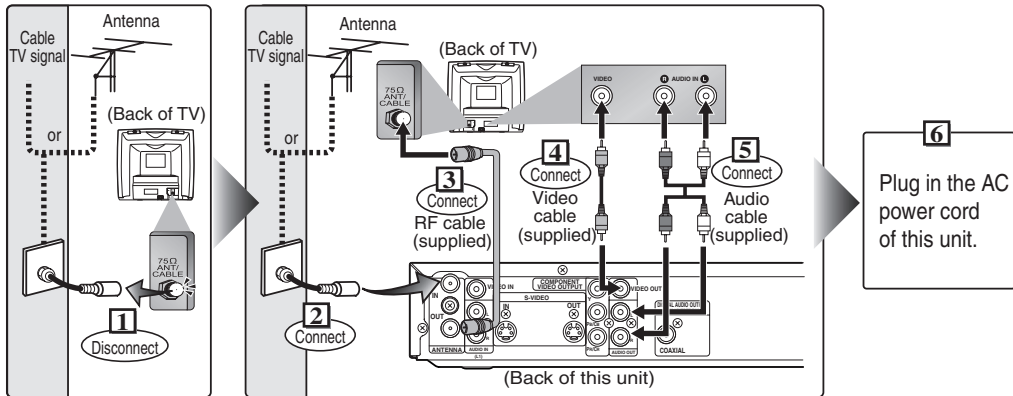

Make one of the following connections, depending on the capabilities of your existing equipment.

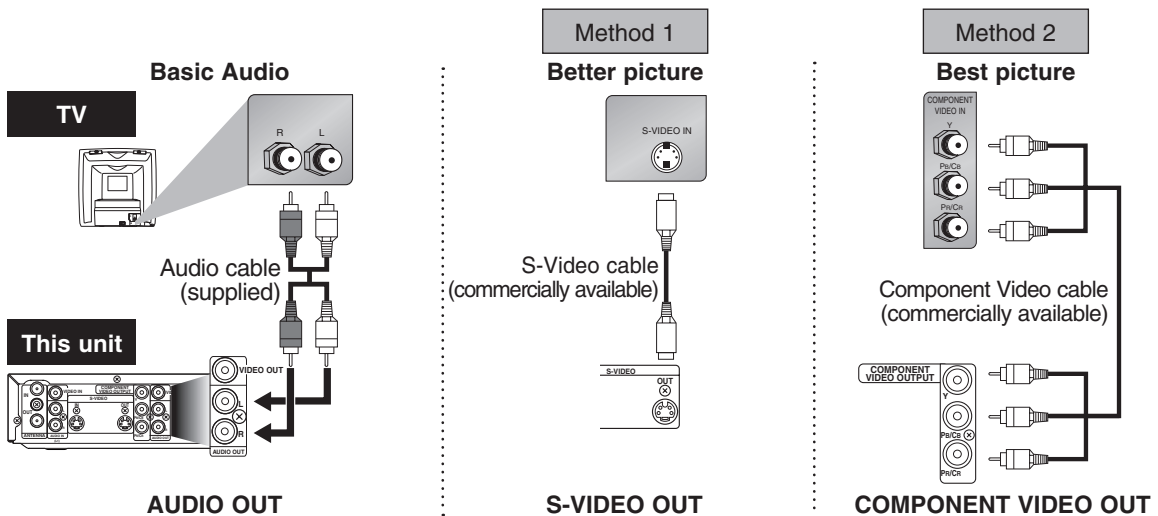

After you have completed connections

- Switch the input selector on your TV to an appropriate external input channel (usually near channel 0). Press a button on the TV's original remote control (refer to "Input Mode Names for Common TV Brands" on page 15) that selects an external input channel until the DVD recorder's picture appears. Check your TV owner's manual for details.

Note

- Connect this unit directly to the TV. If the A/V cables are connected to a VCR, pictures may be distorted due to the copy protection system.
- When Progressive Scan mode is selected, no video signal will be output from the VIDEO OUT or S-VIDEO OUT jack.

This unit is compatible with the Progressive Scan System. The feature provides you with the higher definition images than the traditional output system does. To utilize this feature, you must set Progressive Scan mode to "ON" in the Setup menu by following the steps below.

- Press **[SETUP]** to call up the Setup menu.
- Select "Playback" using **[▲ / ▼]**, then press **[ENTER]**.
- Select "Video" using **[▲ / ▼]**, then press **[ENTER]**.
- Select "Progressive" using **[▲ / ▼]**, then press **[ENTER]**.
- Select "ON" using **[▲ / ▼]**, then press **[ENTER]**.
- Select "Yes" using **[◀ / ▶]**, then press **[ENTER]**.

If your TV is compatible with Progressive Scan (525p / 480p), you must use the Component Video cable (commercially available) to connect this unit to the TV. (See Method 2 on this page.) Make sure the "P.SCAN" appears on the front panel display. If not, use the video cable and set the Progressive Scan mode to "OFF", or press and hold **[SETUP]** for more than 5 seconds, so that the "P.SCAN" on the front panel display disappears.

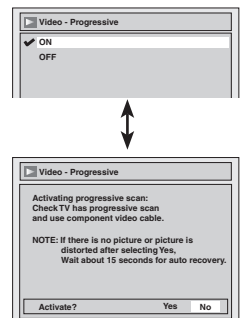

Connections

Connection to a cable box or satellite box

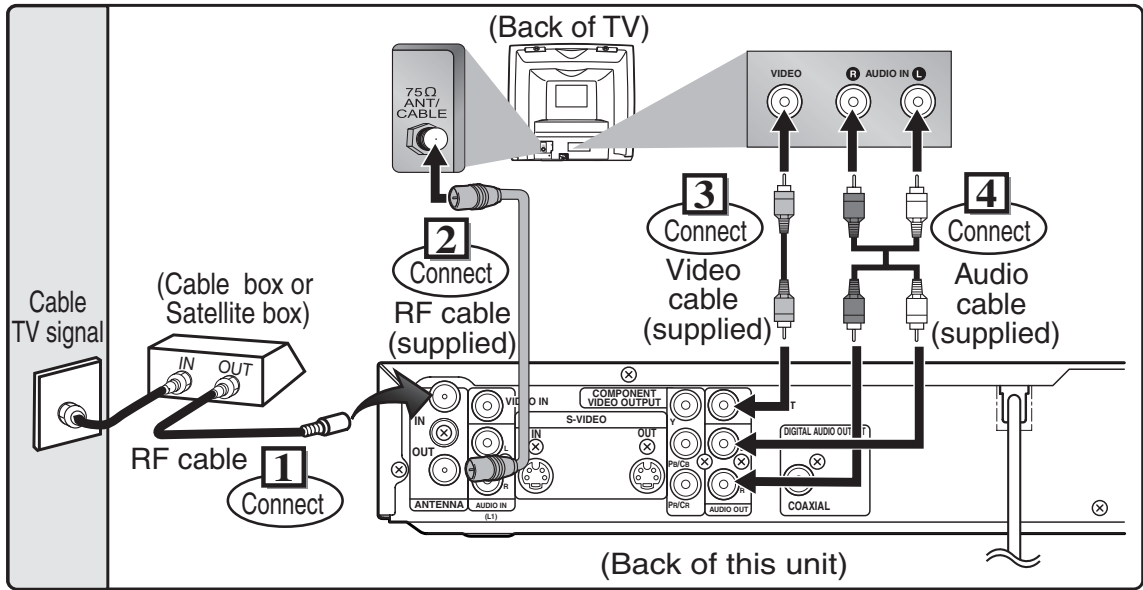

With this setup:

- You can record any unscrambled channel by selecting the channel on the cable box or satellite box. Be sure that the cable box or satellite box is turned on.
- **You cannot record one channel while watching another channel.**

Note to the Cable TV System Installer :

This reminder is provided to call the Cable TV system installer's attention to Article 820-40 of the National Electrical Code, which provides guidelines for proper grounding - in particular, specifying that the cable ground shall be connected to the grounding system of the building, as close to the point of cable entry as possible.

Connections

Connection to an Audio System

- When you change the connections, all devices should be turned off.
- Refer to the operation manual accompanying external devices for more information.

Method 1

Stereo system

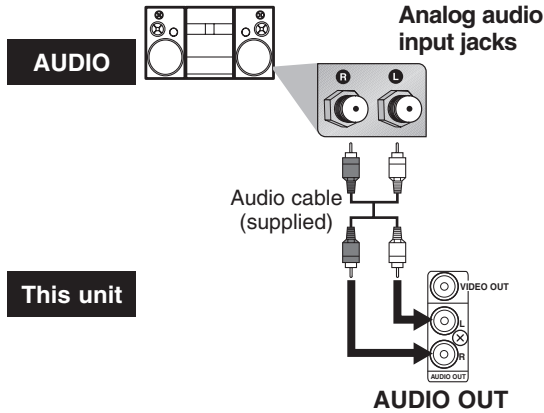

Method 2

Dolby Digital decoder, MD deck or DAT deck

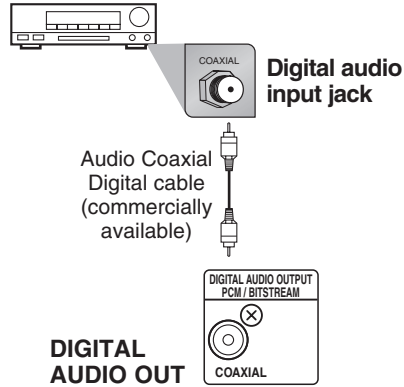

Connection	Setting	Setup > Playback > Audio > Digital Out >	
		PCM	Dolby Digital
If output is Dolby Digital encoded audio, connect to a Dolby Digital decoder.		-	STREAM
Unless connected to a Dolby Digital decoder.		-	PCM
Connecting to an MD deck or DAT deck.		-	PCM

* To complete these settings, refer to pages 68-69.

Note

- Playing a DVD using incorrect settings may generate noise distortion and may also damage the speakers.

Note

- The audio source on a disc in a Dolby Digital Multi-channel surround format cannot be recorded as digital sound by an MD or DAT deck.
- By hooking this unit up to a Multi-channel Dolby Digital decoder, you can enjoy high-quality Dolby Digital Multi-channel surround sound as heard in the movie theaters.
- Playing a DVD using incorrect settings may generate noise distortion and may also damage the speakers.

Input Mode Names for Common TV Brands

Admiral	AUX	Panasonic	TV/VIDEO
Curtis Mathis	LINE1, LINE2, 00, 90, 91, 92, 93	RCA	INPUT, TV/VCR, 00, 90, 91, 92, 93
GE	INPUT, TV/VCR, 00, 90, 91, 92, 93	Samsung	TV/VIDEO
Hitachi	INPUT, AUX	Sanyo	VIDEO
JVC	VIDEO, VIDEO1, VIDEO2, VIDEO3	Sharp	00
Kenwood	AUX	Sony	VIDEO1, VIDEO2, VIDEO3
LXI-Series	00	Toshiba	TV/GAME
Magnavox	AUX CHANNEL	Zenith	00

Getting started

Easy DVD recording

The following will help you to understand easily how to record to DVD discs.

Note:

Make sure batteries are in the remote control and you have connected this unit and the TV correctly.

Step 1: Choose a disc type.

There are several types of recordable DVD discs to choose from. Choose a recordable DVD disc type based on your playing/recording/editing requirements. See "DVD disc types" at the bottom of this page for more information on the differences between the different kinds of compatible media.

This unit can record on the following type of discs.

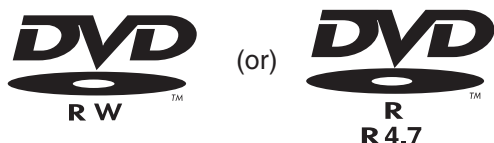

For example, when you want to record repeatedly on the same disc, or when you want to edit the disc after recording, select the rewritable DVD-RW type disc.

When you want to save recordings without any alteration, a non-rewritable DVD-R can be your choice.

Step 2: Insert a blank disc.

Remote Control

1 To turn on

2 To open

3

4 To close

This operation may take a while to be recognized.

DVD disc types

☆☆☆ : Most suitable ☆☆ : Can be used ☆ : Some functions are limited — : Cannot be used

You want to	DVD-RW VR	DVD-RW Video	DVD-R
Record TV programs	☆☆☆	☆☆☆	☆☆
Reuse by deleting unwanted contents	☆☆☆	☆☆	—
Edit recorded contents	☆☆☆	☆	☆
Edit/Record from connected equipment	☆☆☆	☆☆☆	☆☆☆
Copy discs for distribution	☆☆ ¹	☆☆☆	☆☆☆
Play on other DVD equipment	☆☆ ¹	☆☆☆	☆☆☆

Features	DVD-RW VR	DVD-RW Video	DVD-R
Recording			
Rewritable?	Yes	Yes	No
Can create chapters at fixed intervals (auto.)	Yes	Yes	Yes
Can create chapters wherever you like (manual)	Yes	No	No
Can record 16:9 size pictures	Yes	Yes	Yes
Can record Copy-Once programs	Yes	No	No
Editing			
Can perform basic edit functions	Yes	Yes	Yes
Can perform advanced edit functions (Playlist edit)	Yes	No	No

¹ DVD-RW (VR mode) can only be played on DVD equipment that is VR compatible.

Note:
For details of the above functions and implied restrictions, see the explanations inside the manual.

Format the disc

Insert the disc in the recorder. Then, format the disc from the Setup menu. Video format (Video mode) or Video recording format (VR mode) will be available depending on the disc type inserted.

This is necessary to prepare the disc for recording. Details are on pages 26-27.

- * When you format, the entire contents on that disc will be erased.
- * The unit automatically starts formatting when an unused DVD-RW disc is inserted.

Getting started

Easy DVD recording (Cont'd)

Step 3: Select the recording speed.

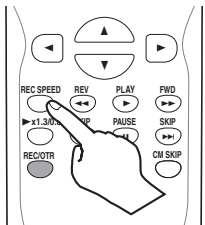

Step 4: Select the desired channel.

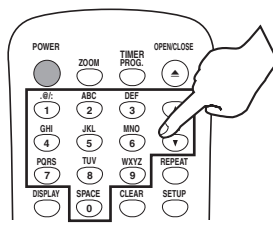

Step 5: Record on DVD disc.

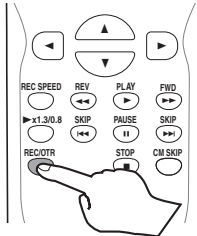

Hint 1: Play the recorded contents

You can select the title you want to play from a displayed menu, and immediately start to play. Recorded contents are easily accessible, with simple procedure of choosing a title on a chapter in the menu screen.

What are titles and chapters?

The contents of DVD disc are generally divided into titles. Titles may be further divided into chapters.

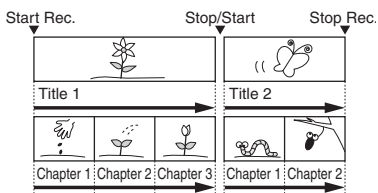

Hint 2: Edit the recorded disc

You will find editing discs is easy. This unit offers convenient edit functions which are possible only with DVD-RW/R discs.

You can edit the following from a title list.

- Putting names on titles
- Setting pictures for thumbnails
- Setting / clearing chapter markers
- Deleting titles or scenes

(Possible editing functions depend on the recording format and editing method.)

Original and Playlist (VR mode)

You can edit the recordings in Playlist without changing the original recordings. Playlist does not take up much disc space.

What "Original" or "Playlist" is for?

Throughout this manual, you will find *Original* and *Playlist* to refer to the actual content and the edited version.

- **Original** content refers to what's actually recorded on the disc.
- **Playlist** content refers to the edited version of the disc; how the Original content is to be played.

Finalizing a Disc

- This will allow a disc that is recorded on this unit to be played back on a different DVD player — without finalization it will not be playable on another player.
- After finalizing a disc if the recording was in Video mode, you cannot edit any information that is on that disc.
- If you have recorded in VR mode on DVD-RW disc then editing is still permitted after finalizing.

Step 6: Stop the recording.

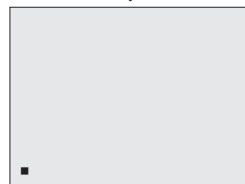
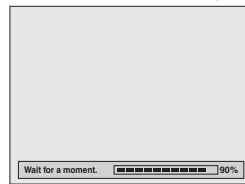
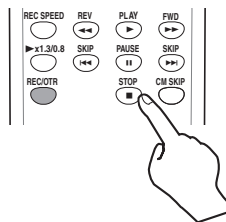

This operation may take a while to be completed.

Getting started

Initial setting

Turn on this unit for the first time, you need to follow these steps.

1
Press [POWER].

2
Turn the TV on. Select the input to which the unit is connected. Refer to the table on page 15.

“Initial Setting” will automatically appear.

3
Using [▲ / ▼], select your desired language for the OSD. Then press [ENTER] to go to next step.

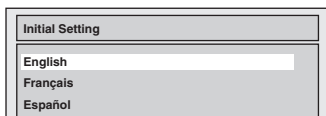

4
Press [ENTER] to Channel Preset.
The unit will start getting channels available in your area.

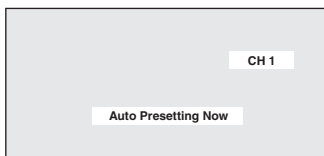

5
After finished channel setting, “Clock Setting” will appear. Then press [ENTER].

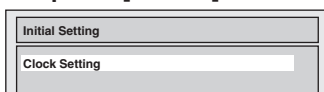

6
Follow to step 3 on page 22 to “Manual Clock Setting”.

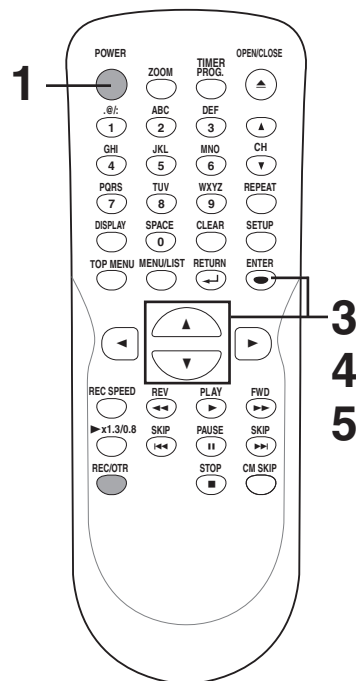

Channel setting

If you have changed antenna connection, we recommend you to program available channels in your area with the following procedures.

Getting channels automatically

1
Press [SETUP].

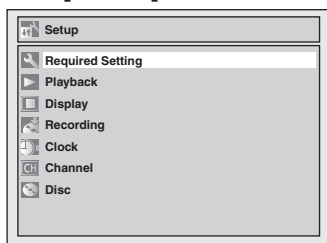

2
Using [▲ / ▼], select “Channel”. Press [ENTER].
Channel menu will appear.

3
Using [▲ / ▼], select “Auto Preset”. Press [ENTER].
The unit will start getting channels available in your area.

4
Press [SETUP] to exit.
• You can select only the channels memorized in this unit by using [CHANNEL ▲ / ▼] or [CH ▲ / ▼].

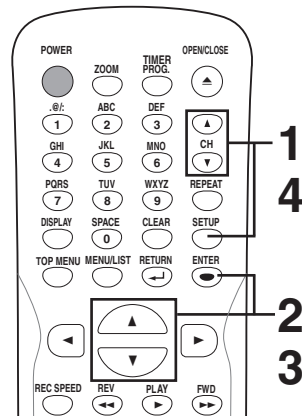

To select a channel

You can select a channel by directly entering channel using the **Number buttons** on the remote control.

Notes for using the Number buttons:

- When selecting cable channels which are higher than 99, enter channel numbers as a three-digit number. (For example: 117, press [1], [1], [7])
- You must precede single-digit channel numbers with a zero (For example: 02, 03, 04 and so on).
- You can select the line input mode (“L1” or “L2”). To select “L1” by pressing [0], [0], [1]. To select “L2” by pressing [0], [0], [2]. Details are on pages 33-34.

Note

- If the auto presetting is canceled during presetting, some channels not yet preset may not be received.
- The selection will depend on how you receive the TV channels.

Press [RETURN ←] or [SETUP] to cancel the auto presetting during scanning.

Getting started

Channel setting (cont'd)

Adding/deleting channels

The channels you no longer receive or seldom watch can be deleted from the memory. You also may add channels into memory.

1
Press [SETUP].

2
Using [▲ / ▼], select "Channel". Press [ENTER]. Channel menu will appear.

3
Using [▲ / ▼], select "Manual Preset". Press [ENTER]. Manual Preset menu will appear.

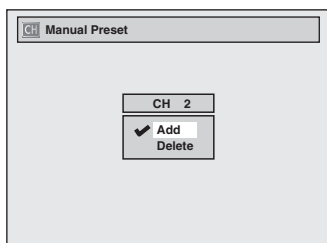

4
Select the channel number to add or delete. Press [◀] or [CH ▼] to move to a lower channel number. Press [▶] or [CH ▲] to move to a higher channel number. Press the Number buttons to select a channel number directly.

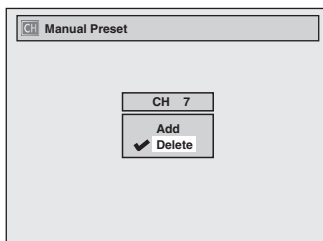

- [CH ▲ / ▼] works on the memorized channel in this unit.
- [◀ / ▶] works on all of channel numbers.

5
Using [▲ / ▼], select "Add" or "Delete". Press [ENTER]. The channel number will be added or deleted from the channel memory. Then the next channel number will appear so that you can continue adding or deleting channels.

6
Press [SETUP] to exit.

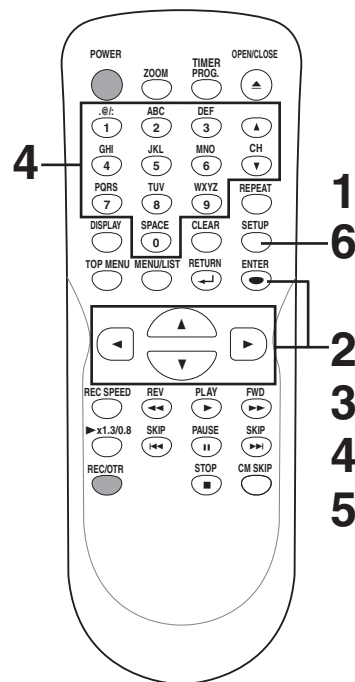

Getting started

Selecting the TV stereo or SAP

You can select a sound channel to output from TV. "Stereo" has been selected as the default.

1

Press [SETUP].

2

Using [▲ / ▼], select "Required Setting". Press [ENTER].

Required Setting menu will appear.

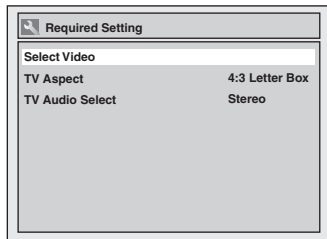

3

Using [▲ / ▼], select "TV Audio Select". Press [ENTER].

Option window will appear.

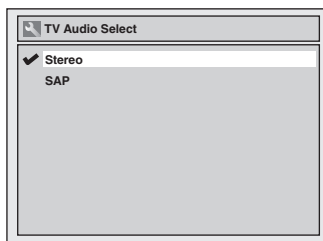

4

Using [▲ / ▼], select "Stereo" or "SAP". Press [ENTER].

Stereo:

Outputs main audio.

SAP (Secondary Audio Program):

Outputs sub audio.

5

Press [SETUP] to exit.

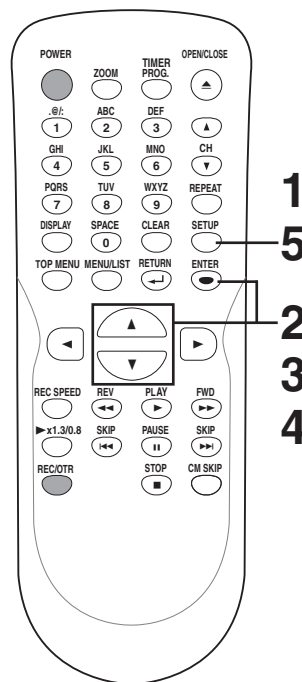

Notes on TV channel audio

- When you record a TV program available in second audio or stereo on a DVD-RW/R, you have to select either Stereo or SAP in the Channel Preset screen beforehand. Refer to the following table to check an appropriate setting.

Selected audio	Broadcast audio	Disc recording	Audio output
Stereo	STEREO+SAP	STEREO	STEREO
	STEREO	STEREO	STEREO
	MONO+SAP	MONO	MONO
	MONO	MONO	MONO
SAP	STEREO+SAP	SAP	SAP
	STEREO	STEREO	STEREO
	MONO+SAP	SAP	SAP
	MONO	MONO	MONO

- You can only play the disc in second audio if a TV program is available in second audio and you set "TV Audio Select" to "SAP".

Getting started

Setting the clock

Set the clock before you try the Timer Recording. If a Public Broadcasting Station (PBS) is available in your area, follow "Auto Clock Setting" below. If not, follow "Manual Clock Setting" on page 22.

Auto Clock Setting

Make sure

- The antenna/Cable TV connections are correct.
- If this unit is connected to a Cable Box or Satellite Box, select the local PBS station on them to set the clock automatically.

1

Press [SETUP].

2

Using [▲ / ▼], select "Clock". Press [ENTER].

Clock menu will appear.

3

Using [▲ / ▼], select "Auto Clock Setting". Press [ENTER].

Option window will appear.

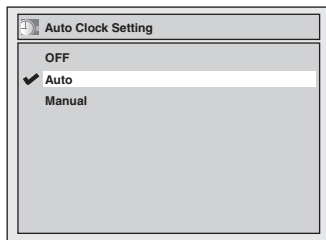

4

- If you do not know your PBS channel number: Using [▲ / ▼], select "Auto". Press [ENTER].

The setting will be activated.

- If you know your PBS channel number: Using [▲ / ▼], select "Manual". Press [ENTER].

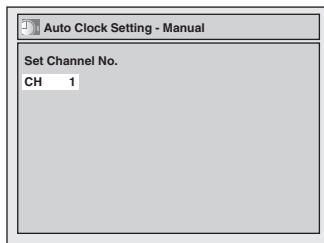

Using the Number buttons or [▲ / ▼], enter your PBS channel number. Press [ENTER].

The setting will be activated.

- If you want to set the clock manually and cancel the Auto Clock Setting function: Using [▲ / ▼], select "OFF". Press [ENTER].

The Auto Clock Setting function will be canceled.

5

Press [SETUP] to exit.

6

Press [POWER] to turn off the unit.

This unit will search for the time only when the power is off. Leave it off for several minutes to give this unit time to set the clock on the front display panel.

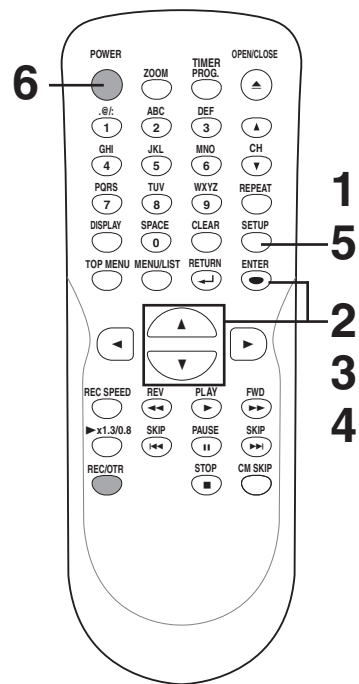

Note

- The clock may set itself automatically after you connect the antenna/cable signal to this unit and plug in the power cord. In this case, the current time will appear on the front panel display.
- If the current time is not displayed or the displayed clock is not correct, set the clock manually.

Getting started

Setting the clock (cont'd)

Manual Clock Setting

1

Press [SETUP].

2

Using [▲ / ▼], select "Clock".
Press [ENTER].

3

Using [▲ / ▼], select "Clock Setting". Press [ENTER].
Clock Setting menu will appear.

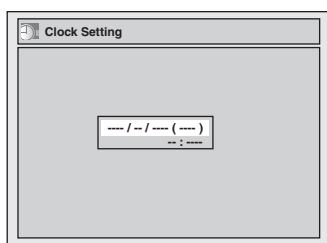

Press [ENTER] again.
Default date will appear.

4

Using [▲ / ▼], enter the date
(month / day / year).
Press [◀ / ▶] to move the cursor.

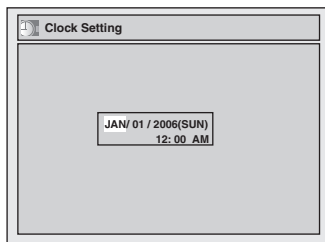

5

Using [▲ / ▼], enter the time
(hour / minute). Press [◀ / ▶].
A cursor will move on AM or PM.

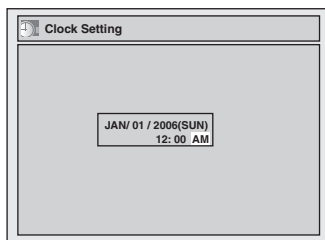

6

Press [▲ / ▼] to select "AM" or
"PM". Press [ENTER].
Clock menu will appear, then the
settings will be activated.
Although seconds are not dis-
played, they begin counting from
zero.

7

Press [SETUP] to exit.

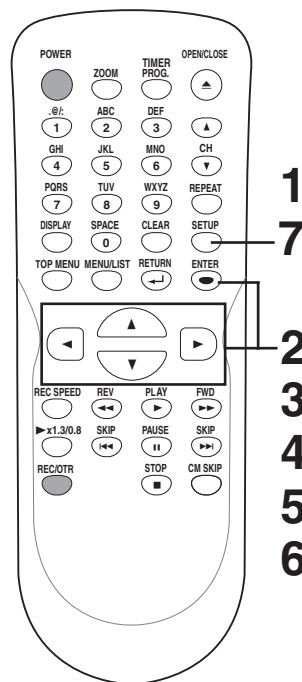

Note

- Your clock setting will be lost if either there is a power failure or this unit has been unplugged for more than 30 seconds when you set the clock manually.

Getting started

Setting the clock (cont'd)

Setting the Daylight Saving Time

When "Daylight Saving Time" is "ON", the unit clock will automatically move forward one hour at 2:00a.m. on the first Sunday in April and move back one hour at 2:00a.m. on the last Sunday in October.

1
Press [SETUP].

2
Using [▲ / ▼], select "Clock".
Press [ENTER].
Clock menu will appear.

3
Using [▲ / ▼], select "Daylight Saving Time". Press [ENTER].
Option window will appear.

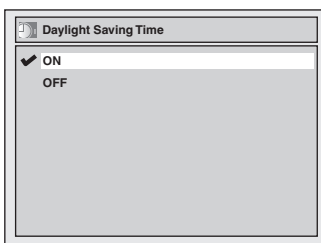

4
Using [▲ / ▼], select "ON" or "OFF". Press [ENTER].
Choose "ON" when currently observing the daylight saving time.

5
Press [SETUP] to exit.

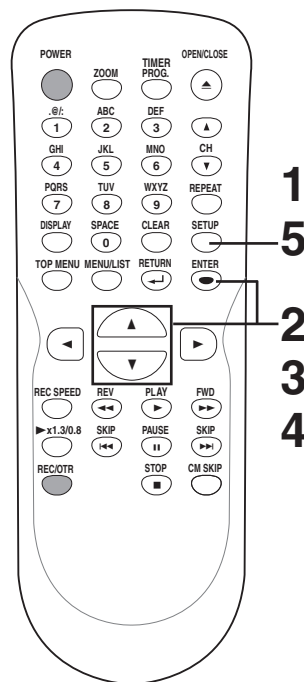

Selecting the TV aspect ratio

You can select the TV aspect ratio to match the formats of what you are playing with the unit and your TV screen (4:3 standard or 16:9 widescreen TV).
"4:3 Letter Box" has been selected as the default.

1
Press [SETUP].

2
Using [▲ / ▼], select "Required Setting". Press [ENTER].
Required Setting menu will appear.

3
Using [▲ / ▼], select "TV Aspect". Press [ENTER].
Option window will appear.

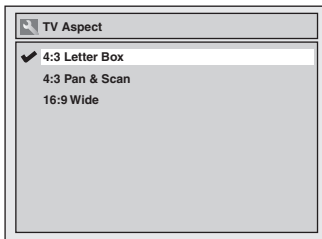

Refer to the Note on this page.

4
Using [▲ / ▼], select a desired option. Press [ENTER].

5
Press [SETUP] to exit.

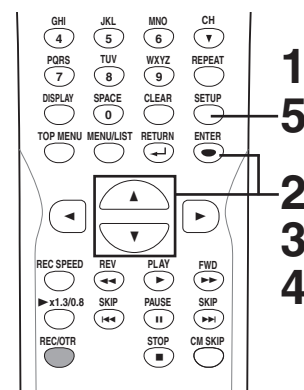

Note

If you have a standard TV:
Select "4:3 Letter Box", so that black bars appear on the top and bottom of the screen. Select "4:3 Pan & Scan" for a full height picture with both sides trimmed.

If you have a widescreen TV:
Select "16:9 Wide".



Recording

Information on DVD recording

Information

This unit can record to DVD-R and DVD-RW discs. DVD-R discs can only be recorded once, and cannot be erased. DVD-RW discs can be recorded and erased many times.





DVD-R discs can only be recorded in Video mode, while DVD-RW discs can select a recording format between Video mode and VR mode.

Logo	Attributes
	8cm/12cm, single-sided, single layer disc
DVD-RW	Approx. max. recording time (SEP mode): 600 minutes (4.7GB) (for 12cm) 180 minutes (1.4GB) (for 8cm)
	
DVD-R	

Recordable disc

- Discs that should or should not be used with this recorder:
DVD-R 8x can be used, 16x may result in a Rec error.
DVD-RW 4x can be used, 6x may result in a Rec error.
- Discs that have been tested and are proven to be compatible with this recorder:
MITSUBISHI KAGAKU MEDIA DVD-R 8x
MITSUBISHI KAGAKU MEDIA DVD-RW 2x
- About Video mode and VR (Video Recording) mode**
Video mode is the same recording format as DVD-Video discs purchased locally, so that you can play in most DVD players. To play in other DVD players, you will need to finalize (see page 35). Unless finalized, you can play, record additionally or edit discs recorded in Video mode with this unit.
VR (Video Recording) mode is a basic recording format for DVD-RW. You can record and edit repeatedly.

DVD players with **RW COMPATIBLE** are capable of playing DVD-RW recorded in VR mode.

Disc type	Disc format	Functions
	Video mode 	Playing, limited recording, limited editing
DVD-RW	VR mode 	Playing, recording, Original/Playlist editing
	Video mode 	Playing, limited recording, limited editing
DVD-R		

Recording speed

You can select a recording speed among 6 options, and the recording time will depend on the recording speed you select as follows.

* **Discs recorded in SLP or SEP on this recorder may not be played back on other DVD recorders or DVD players.**

Disc Size	Recording speed	Recording time	Video/Sound Quality
8cm Disc	XP (1H)	18 min	☆☆☆☆☆☆
	SP (2H)	36 min	☆☆☆☆☆☆
	LP (4H)	72 min	☆☆☆☆
	EP (6H)	108 min	☆☆☆
	SLP (8H)	144 min	☆☆
	SEP (10H)	180 min	☆
12cm Disc	XP (1H)	60 min	☆☆☆☆☆☆
	SP (2H)	120 min	☆☆☆☆☆☆
	LP (4H)	240 min	☆☆☆☆
	EP (6H)	360 min	☆☆☆
	SLP (8H)	480 min	☆☆
	SEP (10H)	600 min	☆

- The recording time are estimates and actual recording time may differ.
- The audio and video quality is getting poorer as the Recording time becomes longer.
- Each time **[REC SPEED]** is pressed, allowed recording time will be displayed.

Note

- This recorder cannot record CD-RW or CD-R discs.**
- DVD-RW/R and CD-RW/R discs recorded on a personal computer or a DVD or CD recorder may not play if the disc is damaged or dirty or if there is dirt of condensation on the player's lens.
- If you record a disc using a personal computer, even if it is recorded in a compatible format, there are cases in which it may not play because of the settings of the application software used to create the disc. (Check with the software publisher for more detailed information.)
- Discs recorded in Video mode on this unit cannot record additionally using other DVD recorders.
- A DVD-RW disc formatted with this unit cannot be used in other DVD recorders without any recording using this unit.
- Since the recording is made by the variable bit rate (VBR) method, depending on the picture you are recording, the actual remaining time for recording may be a little shorter than the remaining time displayed on the OSD.

Recording

Information on DVD recording (cont'd)

Restrictions on recording

You cannot record copy-protected video using this unit. Copy-protected video includes DVD-Video discs and some satellite broadcasts.

If copy-protected material is encountered during a recording, recording will pause or stop automatically and an error message will be displayed on the screen. Video that is "copy-once only" can only be recorded using a DVD-RW disc in VR mode with CPRM (see below).



When recording a TV broadcast or through an external input, you can display copy control information on the screen.

What is "CPRM"?

CPRM is a copy protection system with scramble system regarding the recording of "copy-once" broadcast programs. CPRM stands for Content Protection for Recordable Media. This unit is CPRM compatible, which means that you can record copy-once broadcast programs, but you cannot then make a copy of those recordings. CPRM recordings can only be made on DVD-RW discs formatted in VR mode, and CPRM recordings can only be played on DVD players that are specifically compatible with CPRM.

Information on copy control

Some satellite broadcasts include copy-protected information. For recording these, refer to the following.

Disc type / format	Copy-free	Copy-once	Copy-prohibited
 VR DVD-RW	ver.1.1,1.2	☆	—
	ver.1.1,1.2 CPRM compatible	☆	☆
 Video DVD-RW	ver.1.1,1.2	☆	—
	ver.1.1,1.2 CPRM compatible	☆	—
 DVD-R	ver.2.0	☆	—

☆ Recordable

— Not Recordable

Making discs playable in other DVD player (Finalize)

After recording, you must finalize the disc in order to play on other units. (Refer to page 35.)

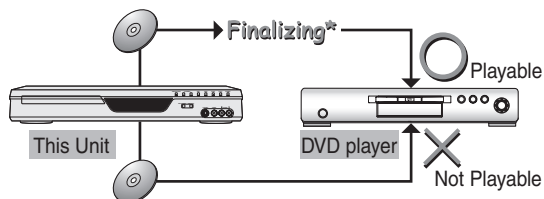

* You cannot finalize discs in other DVD recorders.

After finalizing:

- Once DVD-RW/R (Video mode) is finalized, you cannot record additionally or edit.
- Even if DVD-RW (VR mode) is finalized, you can record additionally or edit the disc.
- When DVD-RW/R (Video mode) is finalized, the Title menu will be created automatically.

To play in other DVD players, finalize discs recorded on this unit.

Recording

Formatting a disc

Choosing the recording format of a blank disc



When inserting a blank disc, the unit automatically starts to initialize the blank disc. You have to select your desired format before inserting the blank disc.

1
Press [SETUP].

2
Using [▲ / ▼], select “Disc”.
Press [ENTER].

Disc menu will appear.
<VR mode>

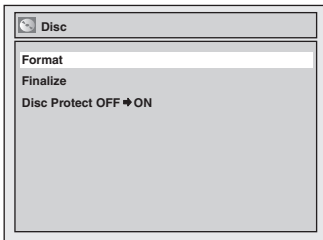

3
Using [▲ / ▼], select “Format”.
Press [ENTER].
Format menu will appear.

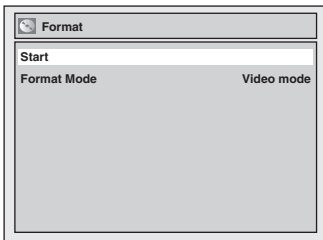

4
Using [▲ / ▼], select “Format Mode”. Press [ENTER].

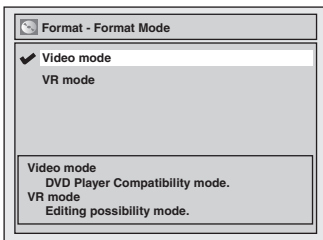

“Video mode” has been selected as the default.

5
Using [▲ / ▼], select “Video mode” or “VR mode”. Press [ENTER].
The recording format will be set.

6
Press [SETUP] to exit.

7
Insert a blank disc.
Formatting will start.

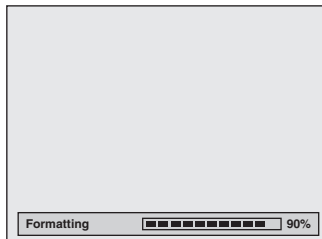

8
Formatting is complete.
“100%” will be indicated.

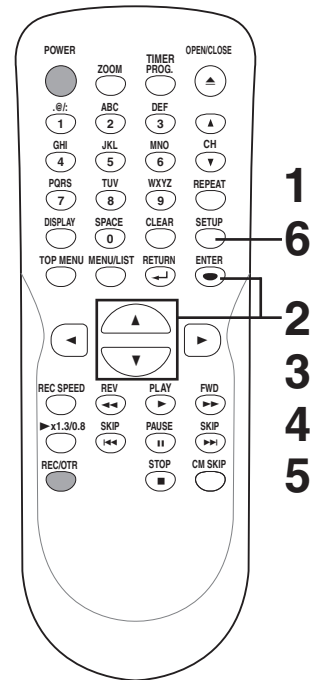

Note

- The recording format setting is effective only for DVD-RW discs. You cannot change the recording format on a DVD-R disc. DVD-R discs will always be in Video mode.
- **You cannot mix two formats on one DVD-RW disc. When you load a disc once recorded before, the recording format cannot be changed even if you change it in the Setup menu.**
- When inserting a blank DVD+R or DVD+RW disc, the error message (“Disc Error”) will appear. This unit is not compatible with a DVD+RW/R disc.
- Playlist will be created automatically when recording on DVD-RW in VR mode.
- A blank chapter may be created depending on the remaining time of the disc.

Recording

Formatting a disc (cont'd)

Reformatting a disc



If you are using a DVD-RW disc, by default it will be Video mode. You can change it to VR mode from the Setup menu.

1
Press [SETUP].

2
Using [▲ / ▼], select "Disc".
Press [ENTER].
Disc menu will appear.

3
Using [▲ / ▼], select "Format".
Press [ENTER].
Format menu will appear.

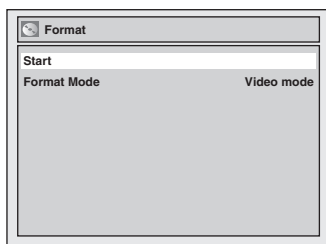

4
Using [▲ / ▼], select "Start".
Press [ENTER].

Setting for Auto Chapter



1
Press [SETUP].

2
Using [▲ / ▼], select
"Recording". Press [ENTER].

3
Using [▲ / ▼], select "Auto
Chapter". Press [ENTER].

Final confirm window will appear.

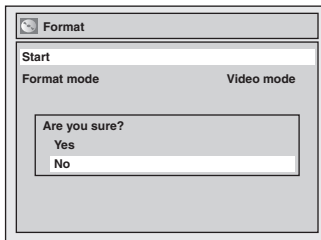

5
Using [▲ / ▼], select "Yes".
Press [ENTER].
Formatting will start.

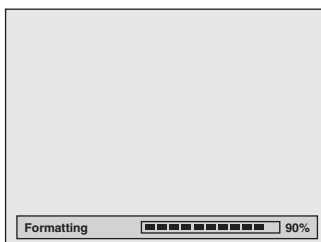

6
Formatting is complete.
"100%" will be indicated.

This operation may take a while to be completed.

Note

- When you reformat the disc, the contents of the disc will be erased.
- If you want to cancel format at step 4 or 5, select "No".

Option window will appear.

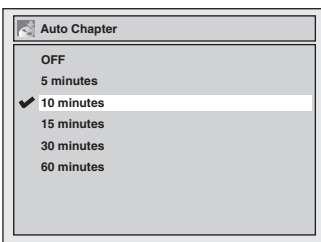

"10 minutes" has been selected as the default.

4
Using [▲ / ▼], select a desired
time option. Press [ENTER].

5
Press [SETUP] to exit.

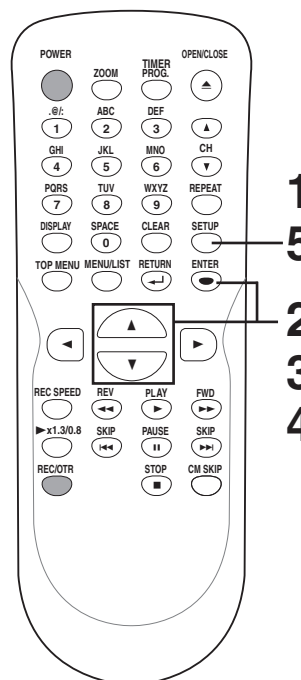
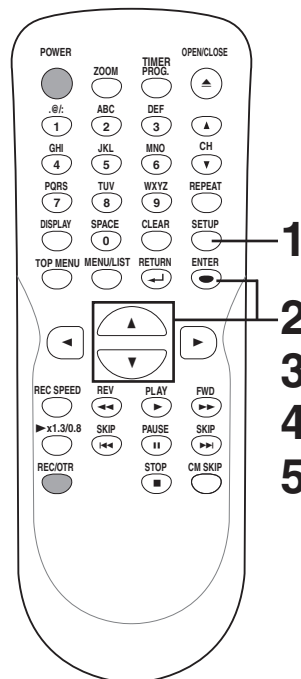

Recording

Basic recording



Follow the steps below to record TV programs.

1

Turn on the unit. Load a recordable disc.

Make sure that the TV input is set on the unit.

This operation may take a while to be recognized.

2

Using [REC SPEED], select a recording speed.



Refer to "Recording speed" on page 24.

3

Using [CH ▲ / ▼] or the Number buttons, select a desired channel to record.



4

Press [REC/OTR] to start recording.

"●" mark will be displayed for 5 seconds.

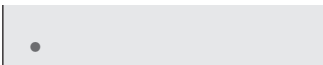

Press [REC/OTR] to resume.
Press [PAUSE II] or [REC/OTR] again to start recording again.

5

Press [STOP ■] to stop recording.

This operation may take a while to be completed.

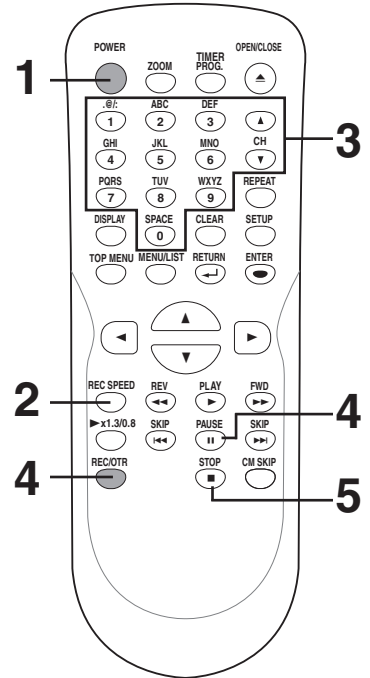

Note

- Recording starts immediately and continues until the disc is full or you stop recording.
- When the clock setting has not been made, the space for a date and time of title names in the Original list or Playlist will be blank.
- When you record a TV program which has Stereo and SAP audio on a DVD-RW/R, you have to select the TV channel audio (Stereo or SAP) beforehand. Only the selected channel audio will be recorded. Refer to "Selecting the TV stereo or SAP" on page 20 for more details.
- **You cannot mix two formats on one DVD-RW disc.** When you load a disc once recorded before, the recording format cannot be changed even if you change it in the Setup menu.
- You cannot change the recording speed during the REC pause mode.
- You can change a channel during the REC pause mode.

Recording

One-touch Timer Recording



This is a simple way to set the recording time in blocks of 30 minutes. Check that the disc you are recording onto has enough space for the time you set. When the recording finishes the recorder automatically goes into standby.

1

Turn on the unit and load a recordable disc.

Make sure that the TV input is set on the unit.

This operation may take a while to be recognized.

2

Using [REC SPEED], select a recording speed.

Refer to "Recording speed" on page 24.

3

Using [CH ▲ / ▼] or the Number buttons, select a desired channel to record.

4

Press [REC/OTR] repeatedly to select desired recording time.

Recording times appear on the TV screen (30 minutes to 8 hours).

Recording will start.

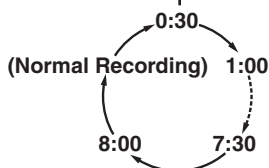

When the unit reaches the specified time, it will be turned off automatically.

To change the recording length during the One-touch Timer Recording, press [REC/OTR] repeatedly until the desired length appear.

To cancel the One-touch Timer Recording within the specified time, press [STOP ■] .

This operation may take a while to be completed.

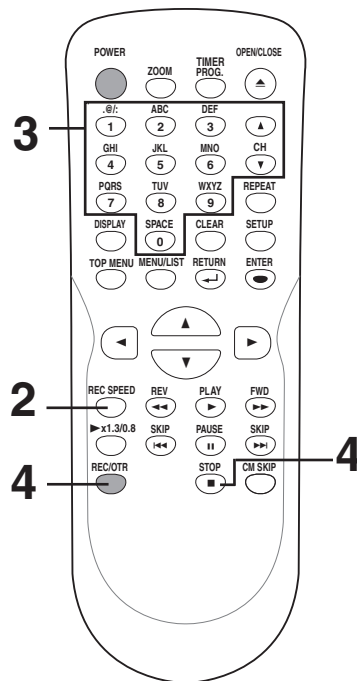

Note

- The remaining recording time will appear on the display panel during a One-touch Timer Recording. Press [DISPLAY] to see it on the TV screen.
- You cannot pause a One-touch Timer Recording.
- Unlike a Timer Recording, you can perform the following operations during a One-touch Timer Recording.
 - Turning the power off
 - Using [REC/OTR] and [STOP ■]
- The unit will be turned off automatically under the following conditions.
 - 1)No space remained on the disc
 - 2)When a power failure occurs

Before you start

Connections

Getting started

Recording

Playing discs

Editing

Changing the Setup menu

Others

Español

Recording

Timer Recording



You can program the unit to record up to 8 programs within a month in advance. Daily or weekly program recordings are also available.

- Be sure to set the clock before setting a timer programming.
- Insert a recordable disc.

1

Press [TIMER PROG.].

Timer Programming list will appear.

Date	Start	End	CH	Speed
1. ---				
2. ---				
3. ---				
4. ---				

2

Using [▲ / ▼], select a program number. Press [ENTER].

3

Using [▲ / ▼], enter the Date. Press [▶].

Date	Start	End	CH	Speed
1. JAN/01	--:--	--:--	L1	
2. ---				
3. ---				
4. ---				

When pressing [▼] at the current date, The Date will change as follows.

e.g. January 1st

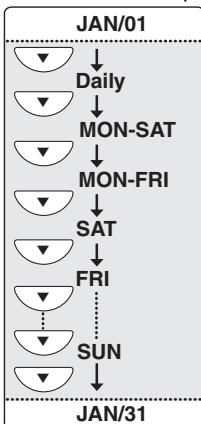

4

Using [▲ / ▼], enter the Start and End. Press [▶].

Date	Start	End	CH	Speed
1. JAN/01	12:57AM	--:--	L1	
2. ---				
3. ---				
4. ---				

5

Using [▲ / ▼], select the channel number to record. Press [▶].

Date	Start	End	CH	Speed
1. JAN/01	12:57AM	1:57AM	CH 8	
2. ---				
3. ---				

To record from external input, select L1 or L2.

6

Using [▲ / ▼], select a recording speed. Press [▶].

Date	Start	End	CH	Speed
1. JAN/01	12:57AM	1:57AM	CH8	1H
2. ---				

Refer to "Recording speed" on page 24.

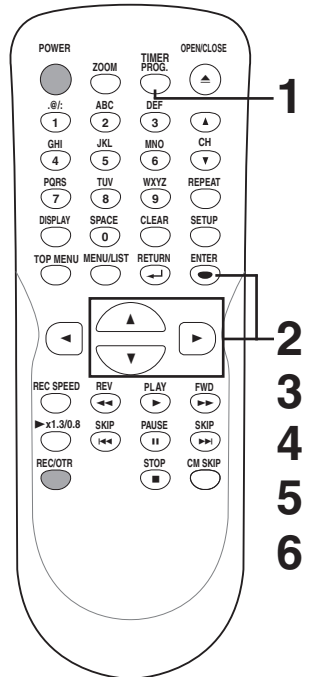

Note

- **If you have not set the clock yet:**
A manual clock setting menu will appear instead of the Timer Programming list at step 1. Continue with the step 2 in "Manual Clock Setting" on page 22 before setting a timer programming.
- Press [◀ / ▶] to move the cursor to the left and the right in the Timer Programming list.
- After step 8, the recording will start immediately before the recording time you set.

Recording

Timer Recording (cont'd)

7

Press [ENTER] when information is entered. Your program setting will be stored.

- To set another program, repeat steps 2 to 7.
- To exit, press [TIMER PROG.] or [SETUP].
- When two or more programs are overlapped, "Overlap" and the overlapped program number will appear in the display.

Checking, canceling, or correcting the timer programming information

1

Press [POWER].

Indicator disappears from the front panel display.

2

Press [TIMER PROG.].

Timer Programming list will appear.

Timer Programming				
Date	Start	End	CH	Speed
1. JAN/01	12:57AM	1:57AM	CH8	1H
2. ---				

3

Check the information on the list you will need.

8

Press [POWER] to turn off.

Indicator will appear on the front panel display.

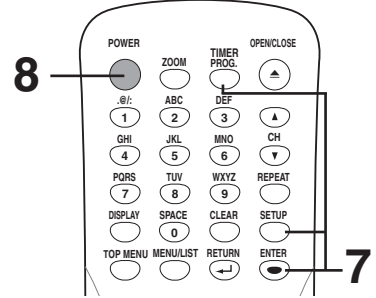

4

To clear the timer programming: Using [▲ / ▼], select your desired program. Press [CLEAR].

To correct the timer programming:

Using [▲ / ▼], select your desired program. Press [ENTER].

Next, correct the timer programming by using [▲ / ▼ / ◀ / ▶]. Finally, Press [ENTER] again.

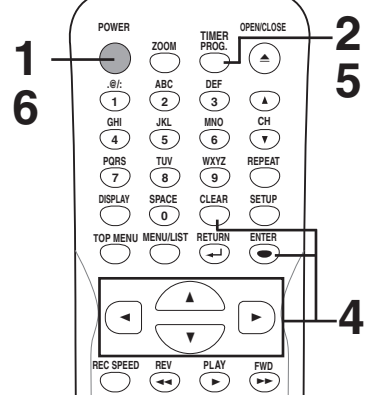

5

Press [TIMER PROG.] to exit.

6

Press [POWER] to return to the timer standby mode.

Note

- Press [TIMER PROG.] to check the timer programming in process. When the Timer Recording is proceeding, that program will be highlighted in red.

To stop the Timer Recording in process

Press [STOP ■] on the front panel of the unit.

[STOP ■] on the remote control is not effective.

If the timer program did not complete correctly, the error number appears in the Timer Programming list.

Timer Programming				
Date	Start	End	CH	Speed
* JAN/01	12:57AM	1:57AM	CH8	E22
2. ---				
3. ---				
4. ---				
5. ---				
6. ---				
7. ---				
8. ---				

Press [CLEAR] to erase the selected program.

Each error number means:





E1-22 E37-39	Recording error other than below	E35	PCA full
E23-24	Unrecordable disc	E36	Already finalized Video format disc
E25-28	Copy prohibited program	E40	Some portion has not been recorded because of program overlapping. Recording did not start at the start time.
E29	Disc protected		
E30	Disc full		
E31-32	Already 99 titles recorded		
E33	Already 999 chapters recorded	E41	Power failed
E34	No space for Control information	E42	No disc when recording

- A program with the error number is grayed and asterisked in the Timer Programming list.
- Once the Timer Programming list with error line(s) is displayed, or after canceling and setting again the timer standby mode, the program line(s) with error will be cleared.

Recording

Timer Recording (cont'd)

Hints for Timer Recording

- If there is a power failure or this unit has been unplugged for more than 30 seconds, the clock setting and all timer programming will be lost.
- If a disc is not on the tray, the  indicator flashes and Timer Recording cannot be performed. In some cases, the  indicator appears momentarily around the start point as the unit attempts to record. Please insert a recordable disc.
- When all the Timer Recording is completed, the  indicator flashes. To play or eject the recorded disc, press **[POWER]** first, and then press **[PLAY ►]** or **[OPEN/CLOSE ▲]**.
- During the Timer Recording or timer standby ( indicator is on the front panel display), any operations on the unit will not be available. To make these operations available, cancel the Timer Recording or timer standby first ( indicator disappears).
- To cancel the timer standby mode, press **[POWER]**.
- When the Start and the End time are the same, the length of the recording will be set for 24 hours. When the disc reaches at the end during the recording, the unit turns itself off.
- When the programmed Start and End time are earlier than the current time, the setting will not be accepted and be cleared for redoing.
- If the Start time is earlier and the End time is later than the current time, the recording will start right after you turn the power off.

The priority of overlapped settings

This unit records the programs according to priority if the timer programmings are overlapped. The timer programming set previously has priority.

A Timer Recording of lower priority will be canceled, start from the middle or stop on the way.

Check the overlapped timer programmings and change the priority if necessary.

A programming set previously has priority

When the starting time is same:

A program set previously (PROG. A) has priority.

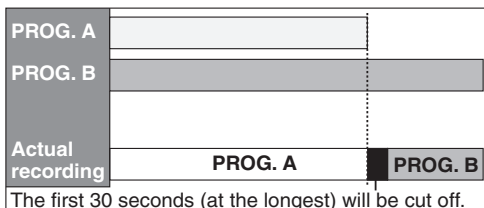

When some programming have been made at the end time of the programming currently being recorded:

A program set previously (PROG. B) has priority.

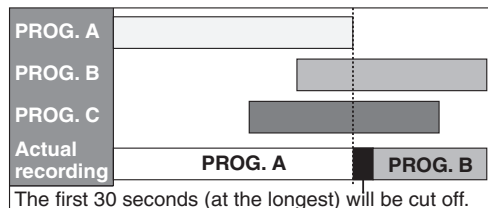

When the recording time is partially overlapped:

PROG. A will start after PROG. B is complete to be recorded.

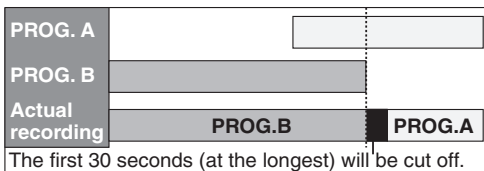

When the recording time is entirely overlapped:

PROG. A will not be recorded.

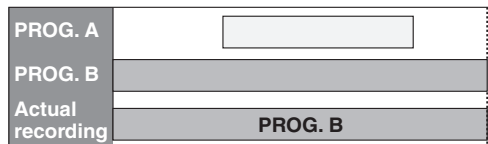

Note for DVD recording

- When the recording time of two programs are overlapped, or the End time of a program and the Start time of another is the same, the first 30 seconds (at the longest) of the subsequent program will be cut off.
- If the cut-off portion comes up to one minute or more, this program will be displayed with error number E40 in the timer programming list.

When the End time of the programming currently being recorded and the Start time of the subsequent program are same:

If PROG. A is a DVD recording program, the beginning of the PROG. B may be cut off.

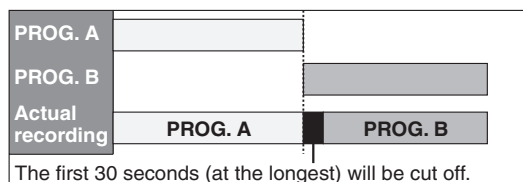

Recording

Settings for an external source

Connection to an external source



Connect the external source properly to the unit by using input jacks either LINE2 (Front) or LINE1 (Rear). When connecting an external equipment of monaural output to this unit, use AUDIO L jack of LINE2 (Front). Use commercially available S-Video or Video cable and an Audio cable for this connection.

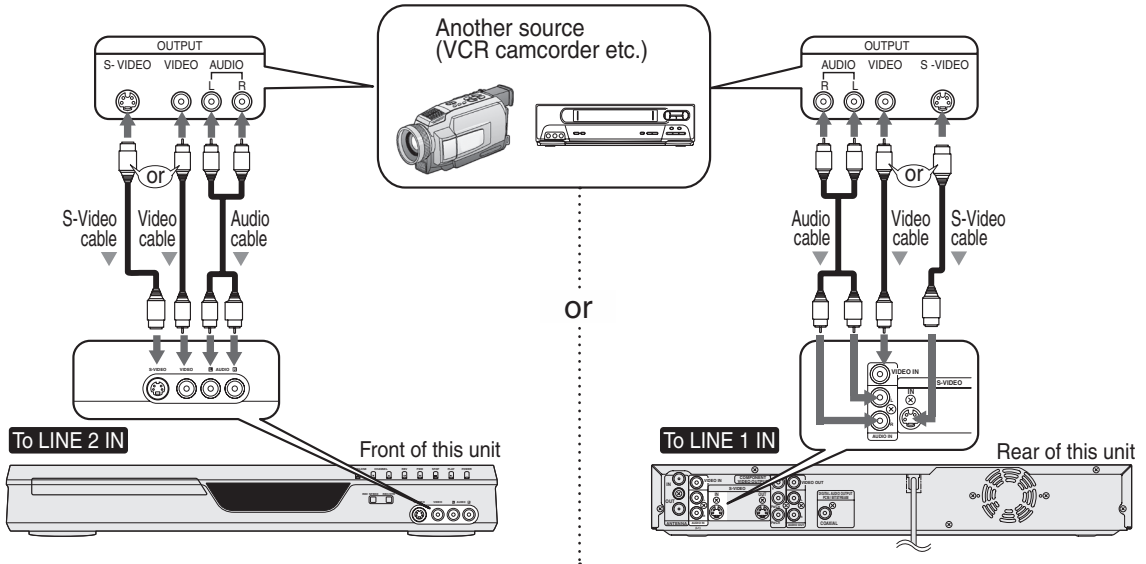

1. Press [SETUP].
2. Using [▲ / ▼], select "Required Setting". Press [ENTER].
3. Using [▲ / ▼], select "Select Video". Press [ENTER].

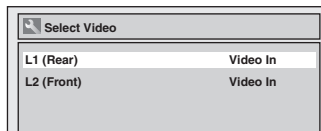

4. Using [▲ / ▼], select "L2 (Front)". Press [ENTER].
4. Using [▲ / ▼], select "L1 (Rear)". Press [ENTER].

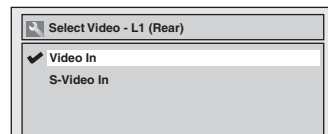
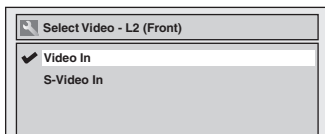

5. Using [▲ / ▼], select the input jack type to connect. Press [ENTER].
If you want to use S-VIDEO input jack, select "S-Video In".
If you want to use VIDEO input (Composite) jack, select "Video In".

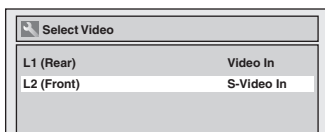

5. Using [▲ / ▼], select the input jack type to connect. Press [ENTER].
If you want to use S-VIDEO IN jack, select "S-Video In".
If you want to use VIDEO IN (Composite) jack, select "Video In".

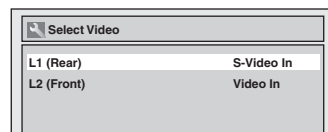

Recording

Settings for an external source (cont'd)

Recording from an external source



Before recording from an external source, see the instructions for the connection on page 33.

1. Turn the TV and this unit on, and be sure to select the input of the TV to which the unit is connected.

Refer to the table on page 15.

2. Press [OPEN/CLOSE ▲] to open the disc tray. Place the disc to record properly.

3. Press [OPEN/CLOSE ▲] to close the disc tray.

This operation may take a while to be recognized.

4. Select the input of the unit which the external equipment is connected. (L2 or L1)

- To use the input jacks on the back of this unit, select "L1" position by pressing [0], [0], [1] on the remote control or the [CHANNEL ▼ / ▲].
- To use the input jacks on the front of this unit, select "L2" position by pressing [0], [0], [2] on the remote control or the [CHANNEL ▼ / ▲].

5. Select a recording speed pressing [REC SPEED].

Refer to "Recording speed" on page 24.

6. Press [REC/OTR] on the unit to start recording.

7. Press "Play" on the external source to record from.

8. Press [STOP ■] on the unit to stop recording.

This operation may take a while to be completed.

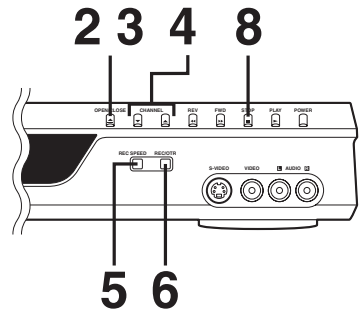
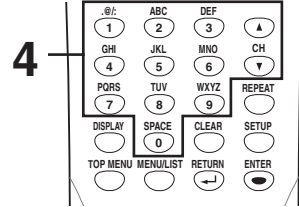
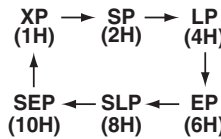

Setting a disc to protect



To prevent accidental recording, editing or erasing the titles, you can protect them from the Setting menu.

1 Press [SETUP].

2 Using [▲ / ▼], select "Disc". Press [ENTER]. Disc menu will appear.

3 Using [▲ / ▼], select "Disc Protect OFF → ON". Press [ENTER].

Confirm window will appear.

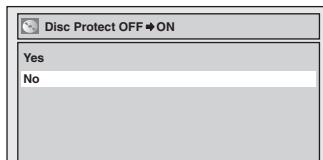

4 Using [▲ / ▼], select "Yes". Press [ENTER]. A disc will be protected.

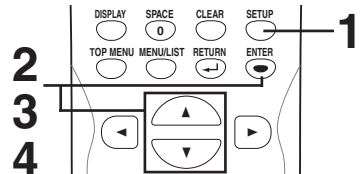

Note

- The Disc Protect setting is available only when a disc with VR mode is inserted.
- You can select only the Disc Protect menu when a protected disc is inserted.
- To cancel the disc protect:** When you insert a disc protected with this unit, "Disc Protect ON → OFF" will appear instead of "OFF → ON".

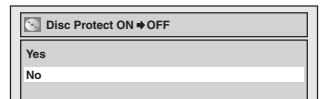

To release the protect for the disc, select "Disc Protect ON → OFF" at step 3, then select "Yes".

Recording

Finalizing the discs



You will need to finalize discs recorded in Video mode to play in other DVD players.

Finalizing may take several minutes up to an hour. (A disc recorded in Video mode can take up to 15 minutes. A disc recorded in VR mode can take up to 60 minutes.)

A shorter recording period on the disc will require a longer time period for finalization. Do not unplug the power cord during finalization.

Details are on pages 24-25.

1
Press [SETUP].

2
Using [▲ / ▼], select "Disc".
Press [ENTER].
Disc menu will appear.

3
Using [▲ / ▼], select "Finalize".
Press [ENTER].
Confirm window will appear.

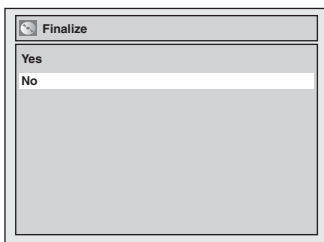

4
Using [▲ / ▼], select "Yes".
Press [ENTER].
Finalizing will start.



To cancel finalizing...
(DVD-RW only)

- To cancel finalizing at step 4, Press [STOP ■], select "Yes", then press [ENTER]. Finalizing is canceled and the unit will be in stop mode.

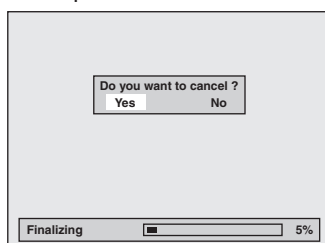

- If ⓪ appear when pressing [STOP ■], you cannot cancel finalizing because the finalizing has been in certain progress.
- When selecting "No" and press [ENTER] or [RETURN ←], finalizing will be continued.
- You cannot cancel finalizing the DVD-R disc once it has started.

This operation may take a while to be completed.

5
Finalizing is complete.

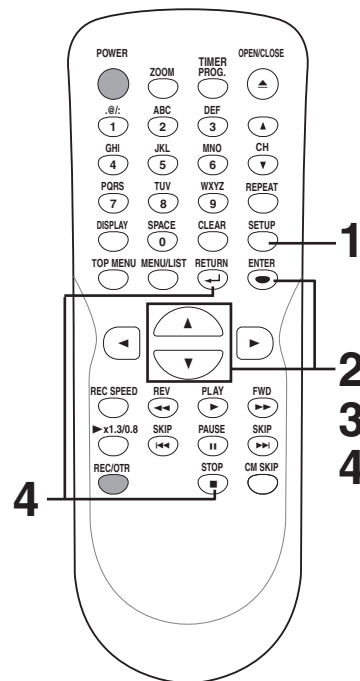
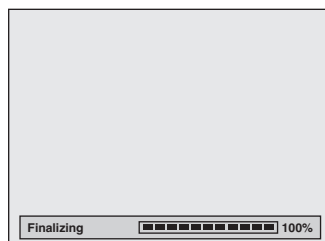

Note

- Finalizing discs in Video mode automatically creates title menus.
- Once you have finalized a disc recorded in Video mode, you cannot edit or record anything else on that disc. Discs recorded in VR mode can still be recorded and edited on this recorder even after finalized.
- When you insert a DVD-RW disc finalized with this unit, "Undo Finalize" will appear instead of "Finalize".

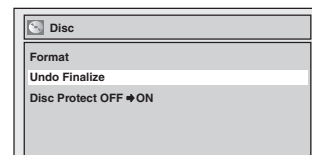

To release the finalizing for the disc, select "Undo Finalize" at step 3.

- DO NOT power off during finalizing, this will result in malfunction.

Recording

Finalizing the discs (cont'd)

Auto finalize



You can finalize discs automatically using Auto Finalize function. You can use this function to finalize discs after finishing all Timer Recordings and at the end of the disc space.

1

Press [SETUP].

2

Using [▲ / ▼], select “Recording”. Press [ENTER].
Recording menu will appear.

3

Using [▲ / ▼], select “Auto Finalize”. Press [ENTER].
Auto Finalize menu will appear.

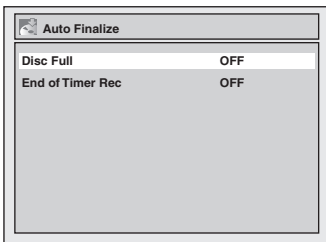

4

Using [▲ / ▼], select “Disc Full” or “End of Timer Rec”. Press [ENTER].

Option window will appear.

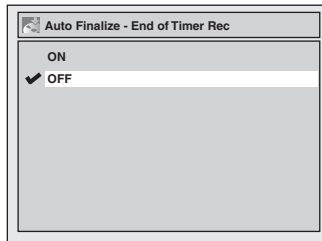
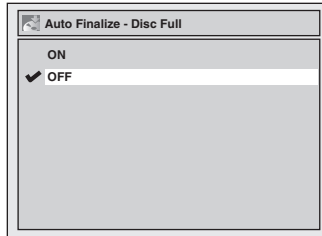

5

Using [▲ / ▼], select “ON”. Press [ENTER].

Your setting will be activated.

6

Press [SETUP] to exit.

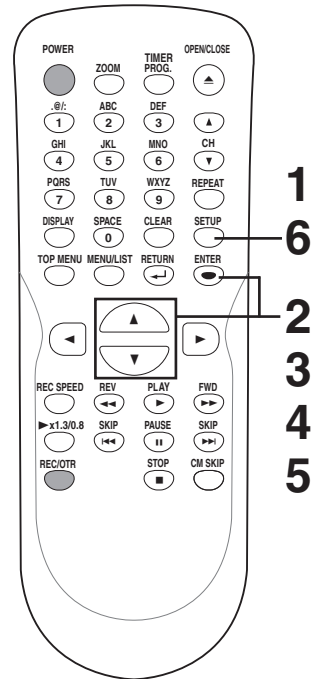

Note

- Auto Finalize does not function for VR format discs.

Playing discs

Information on DVD play

Before you play DVD discs, read the following information.

Playable discs

This unit is compatible to play the following discs. To play a DVD, make sure that it meets the requirements for Region Codes and Color Systems as described followings. Discs that have the following logos will play on the unit. Other Disc types are not guaranteed to play.

Disc	Logo
DVD-VIDEO	
DVD-RW (VIDEO/VR mode)	
DVD-R (VIDEO mode)	
CD-DA (AUDIO CD)	
CD-RW (CD-DA FORMAT, MP3 files)	
CD-R (CD-DA FORMAT, MP3 files)	

DVD is a trademark of DVD Format/Logo Licensing Corporation.

Color systems

DVDs are recorded in different color systems throughout the world. The most common color system is NTSC (which is used primarily in the United States and Canada).

This unit uses NTSC, so DVDs you play must be recorded in the NTSC system. You cannot play DVDs recorded in other color system .

Region codes

This unit has been designed to play DVD discs with Region One (1). DVDs must be labeled for ALL regions or for Region 1 in order to play on the unit. You cannot play DVDs that are labeled for other regions. Look for the symbols below on your DVDs. If these region symbols do not appear on your DVD, you cannot play the DVD in this unit.



The number inside the globe refers to region of the world.

A DVD labeled for a specific region can only play on the unit with the same region code.

Hint for DVD playback

The contents of DVD disc are generally divided into titles. Titles may be further subdivided into chapters.

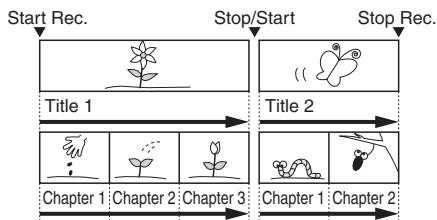

Guide to displays

Press **[DISPLAY]** to call up the Display menu. This menu will give you the information on the playing disc. Some operations are available while disc is playing.

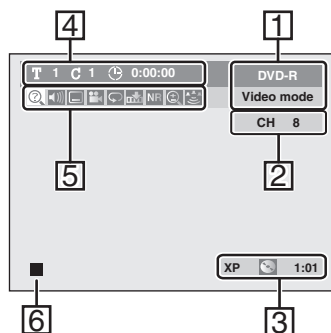

1. Indicates a disc type and a format mode.
NOTE: In some descriptions on this manual, only one disc type is indicated as an example.
2. Indicates a channel number.
3. Indicates a recording mode and possible recording time left.
4. Indicates a title number, chapter number and the time lapse of disc play.

5. Each icon means:

- : Search
- : Audio
- : Subtitle
- : Angle (except VR mode)
- : Repeat
- : Marker
- : Noise Reduction
- : Zoom
- : Surround

6. Indicates current disc status.

Playing discs

Basic playback

Playback



1

Press **[POWER]**.

When you are playing a DVD, turn the TV on and be sure to select the input to which the unit is connected.

2

Press **[OPEN/CLOSE ▲]**.

The disc tray will open.

3

Insert your disc with its label facing up. Align the disc to the disc tray guide.

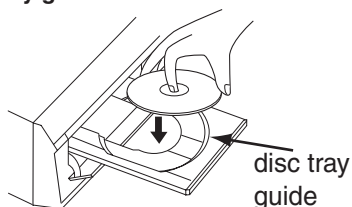

4

Press **[OPEN/CLOSE ▲]** to close the disc tray.

This operation may take a while to be recognized.

5

Press **[TOP MENU]** to display the title menu.

You can change "Original" or "Playlist" of VR mode using **[MENU / LIST]**.

<Video mode>

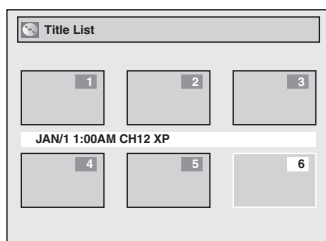

<VR mode>

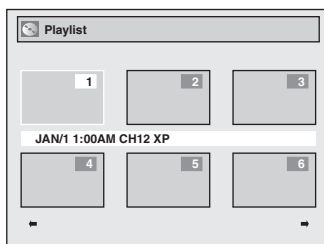

[MENU / LIST]

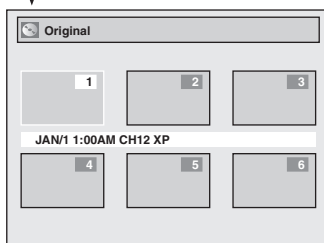

Press **[TOP MENU]** to resume play.

To exit the title menu, press **[STOP ■]** or **[RETURN ↵]**.

6

Using **[▲ / ▼ / ◀ / ▶]**, select a desired title. Press **[ENTER]**.

Option window will appear.

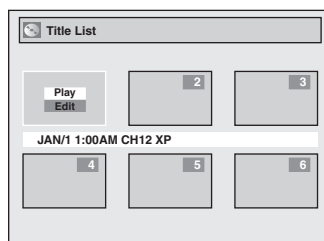

7

Using **[▲ / ▼]**, select "Play". Press **[ENTER]**.

Playback will start.

Press **[PLAY ▶]** in the title list.

Playback will start.

8

Press **[STOP ■]** to stop playback.

To eject the disc, press **[OPEN/CLOSE ▲]** to open the disc tray, then remove the disc before turning the unit off.

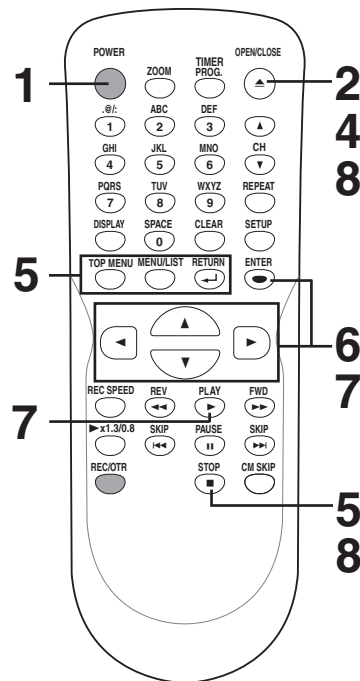

Note

- For DVD-R (Video mode) and DVD-RW (Video mode) discs which are already finalized, a title list will be displayed instead of thumbnails.

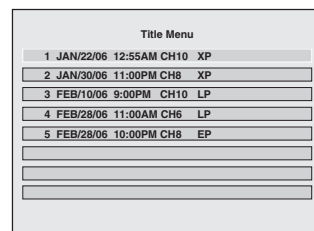

- You can resume play from where you stopped playing the disc. (Resume play) Refer to page 41 for details about resume play.
- Some discs may start playback automatically.

Playing discs

Basic playback (cont'd)



1

Press [POWER].

When you are playing a DVD, turn the TV on and be sure to select the input to which the unit is connected.

2

Press [OPEN/CLOSE ▲] to open the disc tray.

The disc tray will open.

3

Insert your disc with its label facing up. Align the disc to the disc tray guide.

4

Press [PLAY ►] to start playback.

Playback will start.

If you are playing a DVD-Video disc, a menu may appear.

Refer to page 40 for details about the Disc menu.

5

Press [STOP ■] to stop playback.

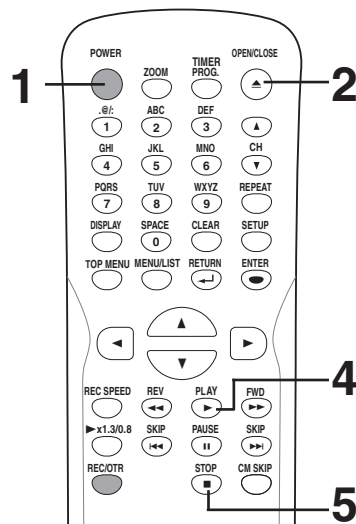

Note

- Some discs may start playback automatically.

Playing MP3 disc



1

In stop mode, press [TOP MENU] to call up the MP3 menu.

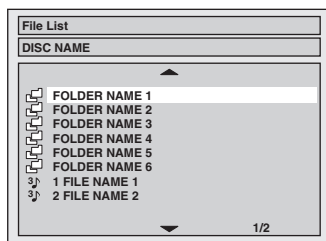

- To exit the menu, press [TOP MENU] again.

2

Using [▲ / ▼], select a desired folder (group) or track. Press [ENTER].

When selecting track:

Playback will start.

When selecting the folder:

The files in folder will appear. Press [▲ / ▼] to select the track or folder you want, then press [ENTER].

- Press [PLAY ►], [ENTER] or [▶] to move to the lower hierarchies.
- Press [◀] or [RETURN ↵] to the previous hierarchy.

Hints for MP3 files:

- Folders are known as Groups, files are known as Tracks.
- Folders are accompanied by folder icon.
- MP3 files are accompanied by MP3 icon. Reproduction will start from the selected track and go to the next one in turn.
- The system can recognize up to 255 groups (or folders) and up to 999 tracks.
- The name of group and track can be displayed in up to 29 characters. Unrecognizable characters will be replaced with asterisks.
- If there are no files in the folder, "No Files" will be displayed.

This unit recommends the files recorded under the following circumstances:

- Sampling frequency: 44.1kHz or 48kHz.
- Constant bit rate: 112kbps - 320kbps.

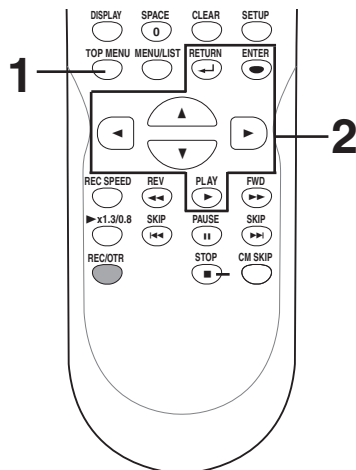

Note

- The audio source of MP3 files cannot be recorded as digital sound by an MD or DAT deck.
- Files whose extension is other than ".mp3(MP3)" will not be listed in the MP3 menu.
- Some unplayable folders or tracks may be listed in the MP3 menu due to the recording status.

Playing discs

Basic playback (cont'd)

Playing discs using the Disc menu



A DVD disc contains a Disc menu that describes the contents or allows you to customize the playback. For example, the menu may offer choices for subtitle languages, special features, or chapter selection.

Sometimes these are displayed automatically when you start playback, otherwise only appear when you press **[MENU / LIST]**.

1

Press **[MENU / LIST]**.

The Disc menu will appear. If the feature is not available,  may appear on the TV screen.

2

Using **[▲ / ▼ / ◀ / ▶]**, select an item. Press **[ENTER]** to confirm.

Continue this step to set up all the features you want or to start playing the disc from the menu.

MENU / LIST button:

Displays a DVD Disc menu which varies with the disc and may be the same as the 'Title menu.'

Cursor ▲ / ▼ / ◀ / ▶ buttons:

Moves the cursor around screen.

ENTER button:

Selects the currently highlighted menu option.

Number buttons:

Selects a numbered menu option (some discs only). (Press **[ENTER]** after.)

3

Press **[MENU / LIST]** to exit the Disc menu.

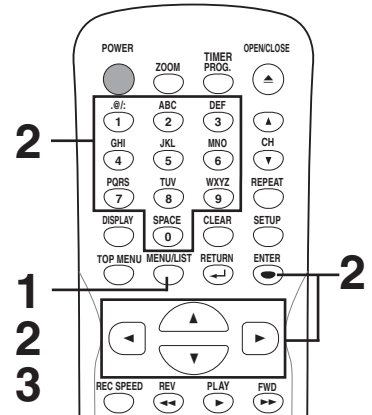

Note

- Menus vary among discs. Refer to the information accompanying the disc for details.

Playing discs using the Title menu



Some DVDs have a Title menu, which lists the titles available on them. It helps you to start play at a specific title.

1

Press **[TOP MENU]**.

The Disc menu will appear. If the feature is not available,  may appear on the TV screen.

2

Using **[▲ / ▼ / ◀ / ▶]**, select a title to play. Press **[ENTER]**. Play will begin at the title you selected.

TOP MENU button:

Displays the 'Title menu' of a DVD disc which varies with the disc.

Cursor ▲ / ▼ / ◀ / ▶ buttons:

Moves the cursor around screen.

ENTER button:

Selects the currently highlighted menu option.

Number buttons:

Selects a numbered menu option (some discs only). (Press **[ENTER]** after.)

3

Press **[TOP MENU]** to exit the Title menu.

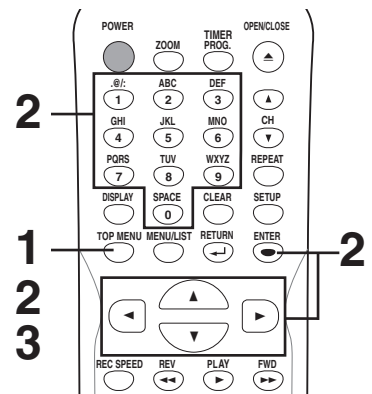

Note

- **[TOP MENU]** will not always be active with all DVDs.
- Menus vary among discs. Refer to the information accompanying the disc for details.

Pause



1

During playback, press **[PAUSE II]**.

Play will pause and sound will be muted.

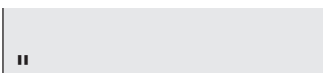

2

Press **[PLAY ▶]** to resume play.

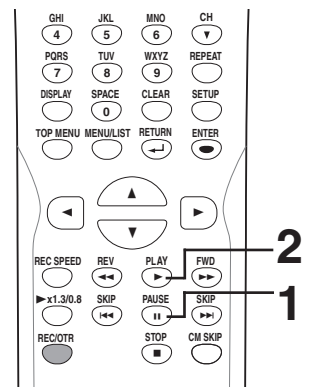

Playing discs

Special playback

Resume play



You can resume play from where you stopped playing the disc last.

- 1 During playback, press [STOP ■]. The resume message will appear.

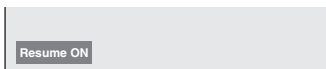

- 2 Press [PLAY ►]. In a few seconds, play will resume from the point at which it stopped last. You can resume play at the same point even if you turn off the unit.

To cancel the resume play and start playing the disc from the beginning, press [STOP ■] the second time while the play is stopped.

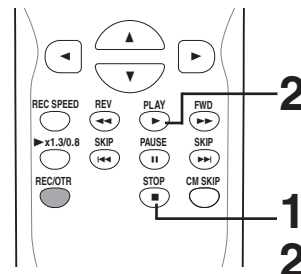

- Note**
- For MP3 files, playback will resume from the beginning of the track at which playback was stopped.

Fast forward / Fast reverse



- 1 During playback, press [FWD ►►] or [REV ◄◄]. Every time you press [FWD ►►] or [REV ◄◄], approximate speed will be changed as follows. Fast forward or fast reverse playback across titles (for DVD discs) or tracks (for MP3) is not possible.

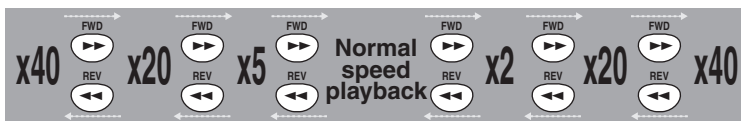

For Audio CDs, approximate speed is fixed at x8 with sound. For MP3 files, approximate speed is fixed at x8 with sound. To return to the normal play, press [PLAY ►].

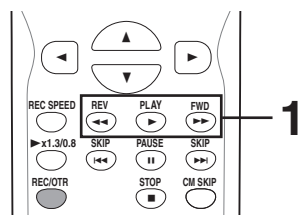

- Note**
- Forward/reverse speed will be indicated with icons as follows.
Forward (Approx. Speed)
x2: [two right arrows]
x20: [ten right arrows]
x40: [twenty right arrows]
Reverse (Approx. Speed)
x5: [five left arrows]
x20: [ten left arrows]
x40: [twenty left arrows]

Skipping TV commercials during play



You can skip TV commercials by pressing [CM SKIP], so that you can enjoy the recorded programs without interrupting.

- 1 During playback, press [CM SKIP]. Normal play will start at 30 seconds ahead from the point you press [CM SKIP]. Every time you press [CM SKIP], the searching point will be extended by 30 seconds ahead. You can press up to 6 times (180 seconds).

e.g. Press [CM SKIP] once.

(forwarding 30 seconds)

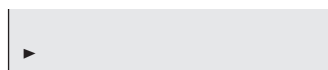
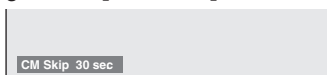

Playback will restart automatically.

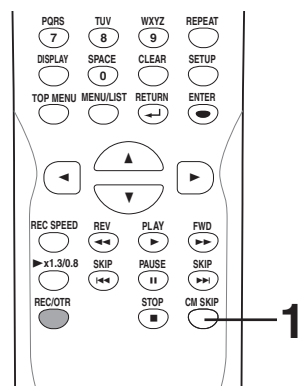

Playing discs

Special playback (cont'd)

Rapid Play



Rapid Play function is available only during playback.

Available only on discs recorded in the Dolby Digital format, Rapid Play plays back in a slightly faster/slower speed while keeping the sound quality just as normal playback.

1
During playback, press [▶x1.3/0.8].

▶🎵 : Press [▶x1.3/0.8] once during playback. Plays back approximately at 0.8 times of normal playback.

▶🎵🎵 : Press [▶x1.3/0.8] twice during playback. Plays back approximately at 1.3 times of normal playback.

▶ : Press [▶x1.3/0.8] three times to play back in normal speed. No effects.

2
Press [PLAY ▶] to continue the normal playback.

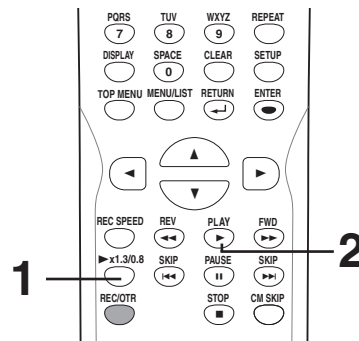

Note

- Audio (language) setting cannot be changed while using this mode.
- This feature may not work at some point in a disc.
- Audio is PCM during Rapid play mode.

Step by step playback



1
During playback, press [PAUSE II]. Play will pause and sound will be muted.

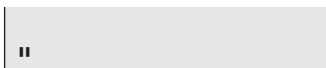

2
Press [SKIP ▶▶] repeatedly. The play will advance one frame (or step) at a time when you press [SKIP ▶▶] with the sound muted.

To play step by step backward:
Press [SKIP ◀◀] repeatedly. Every time you press the button, the play will go backward by one frame.

- Press and hold [SKIP ◀◀ / ▶▶] to reverse/advance continuously.

3
Press [PLAY ▶] to resume play.

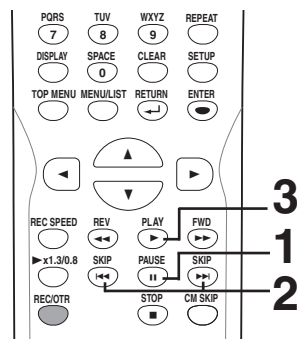

Slow forward / Slow reverse play



1
During playback, press [PAUSE II]. Then press [FWD ▶▶] or [REV ◀◀]. Every time you press [FWD ▶▶] or [REV ◀◀], approximate speed will be changed as follows. (The sound will remain muted.)



To return to the normal play, press [PLAY ▶].

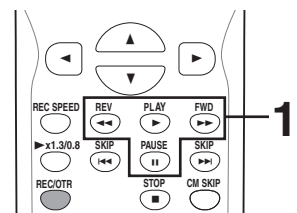

Note

- Slow forward/slow reverse speed will be indicated with icons as follows.
Forward (Approx. Speed)
x1/16: [▶▶▶▶] (4 arrows)
x1/8: [▶▶▶▶▶] (5 arrows)
x1/2: [▶▶▶▶▶▶▶▶▶▶] (10 arrows)
Reverse (Approx. Speed)
x1/16: [◀◀◀◀] (4 arrows)
x1/8: [◀◀◀◀◀] (5 arrows)
x1/4: [◀◀◀◀◀◀] (6 arrows)

Playing discs

Special playback (cont'd)

Zoom



1
During playback, press [ZOOM].
Zoom menu will appear.

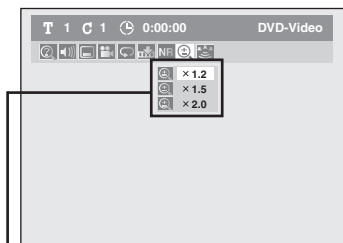

There are four options (x1.0, x1.2, x1.5 and x2.0), these are displayed excluding the current zoom rate.

2
Using [▲ / ▼], select a desired zoom factor to zoom. Press [ENTER].
The zoom area will be displayed.

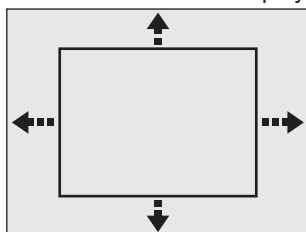

3
Using [▲ / ▼ / ◀ / ▶], select a desired zoom position. Press [ENTER].
The zoom play will start.

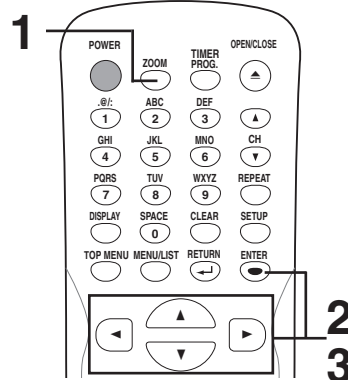

Note

- When selecting a smaller factor than the current one, the zoom area will not be displayed.
- To exit the zoom menu, press [ZOOM] again at step 1.
- To cancel the zoom function, select "x1.0" using [▲ / ▼], then press [ENTER].

Marker Setup



This feature allows you to assign a specific point on a disc to be called back later.

1
During playback, press [DISPLAY].
The Display menu will appear.

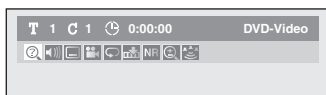

2
Using [◀ / ▶], select [M]. Press [ENTER].
Marker Setup menu will appear.

<DVD-Video>

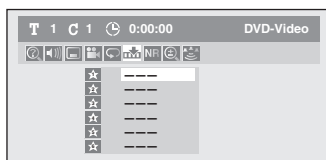

<Audio CD>

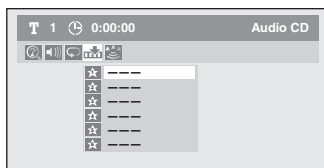

3
Using [▲ / ▼], select a desired marker number. When it reaches the desired point, press [ENTER].
The title (track) number and the time will be displayed.

4
To return to the marker later:
Using [▲ / ▼], select the desired marker number. Press [ENTER].

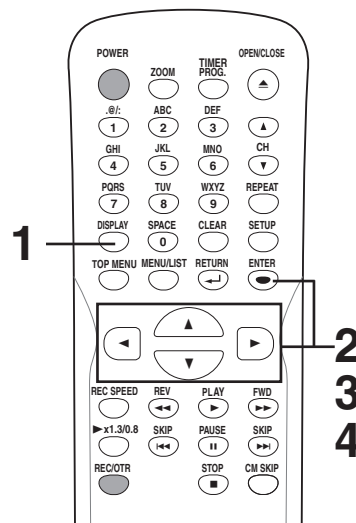

Note

- To clear a marker, select the marker number to be cleared, then press [CLEAR].
- All markers will be erased when you operate these operations listed below.
 - Opening the disc tray
 - Turning off the power
 - Recording to a recordable disc
 - Changing the mode between Original and Playlist (VR mode)
- You can mark up to 6 points.

Playing discs

Search

Title/Chapter search



Using [SKIP <<< / >>>]

1

During playback, press [SKIP >>>] to skip the current title or chapter and move to the next.

The title or chapter will move forward by one at a time.

To go back to the beginning of the current title or chapter, press [SKIP <<<].

Press it repeatedly to go to the previous title or chapter. The title or chapter will move backward one title at a time.

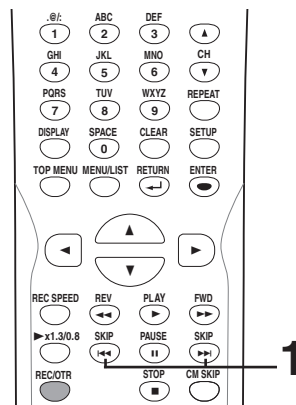

Using [DISPLAY]

1

During playback, press [DISPLAY].

The Display menu will appear.

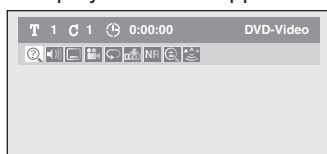

2

Using [◀ / ▶], select [?]. Press [ENTER].

The number next to **T** will be highlighted.

Title:

Using [▲ / ▼] or the Number buttons, enter a desired title number to search. Press [ENTER].

Title search will start.

Chapter:

Press [▶] to move to the number next to **C** for chapter.

Using [▲ / ▼] or the Number buttons, enter a desired chapter number to search. Press [ENTER].

Chapter search will start.

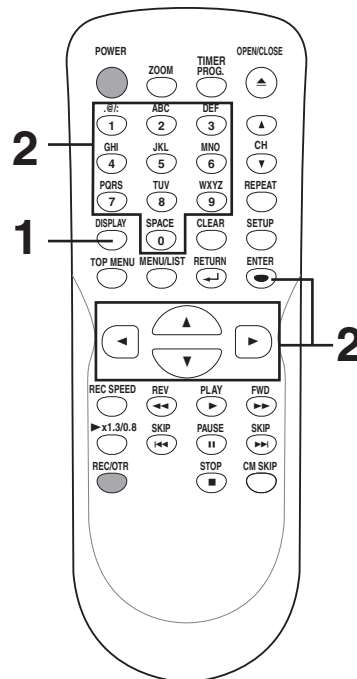

Note

- In search mode display, total numbers of each search contents (title/chapter/time) are shown as a denominator.

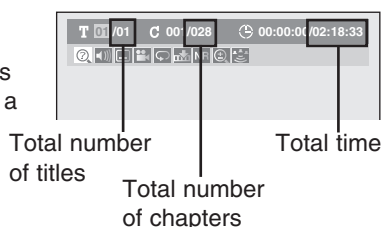

Playing discs

Search (cont'd)

Track search



Using [SKIP ◀◀ / ▶▶]

1

During playback, press [SKIP ▶▶] to skip the current track and move to the next.

The track will move forward one at a time.

To go back to the beginning of the current track, press [SKIP ◀◀].

Press it repeatedly to go to the previous track. The track will move backward one at a time.

Using [DISPLAY]

1

During playback, press [DISPLAY].

The Display menu will appear.

<Audio CD>

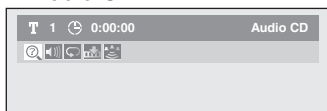

<MP3 files>

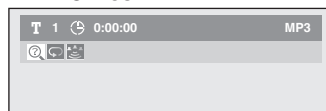

2

Using [◀ / ▶], select . Press [ENTER].

The number next to **T** will be highlighted.

3

Using [▲ / ▼] or the Number buttons, enter a desired track number to search. Press [ENTER].

Track search will start.

Time search



1

During playback, press [DISPLAY].

The Display menu will appear.

<DVD-Video>

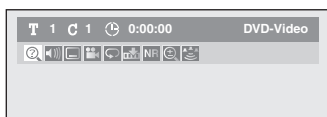

<Audio CD>

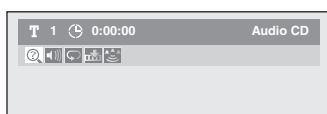

2

Using [◀ / ▶], select . Press [ENTER].

The number next to **T** will be highlighted.

To move to the number next to , press [▶].

When time search is not available, “--:--:--/--:--:--” (“0:00:00/0:00:00” for CD) is displayed instead of time count.

3

Using [▲ / ▼] or the Number buttons, enter a desired time to search. Press [ENTER].

Time search will start.

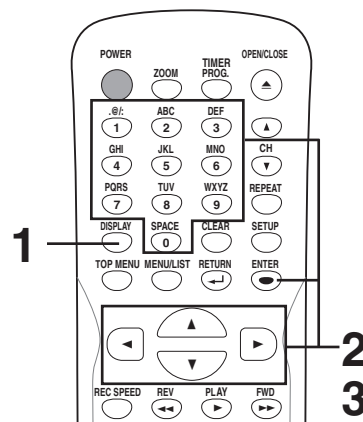
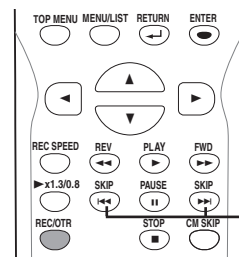

Note

- During CD playback you can enter a track number directly using the Number buttons for track search without displaying the menu.

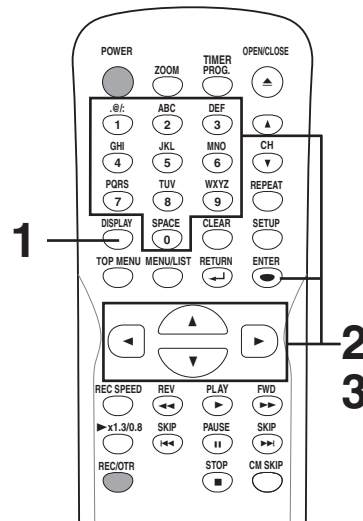

Note

- Time search function is available only in the same track or title.

Playing discs

Repeat/Random/Program playback

Repeat play



1
During playback, press [REPEAT]. Repeat menu will appear.

<DVD-Video>

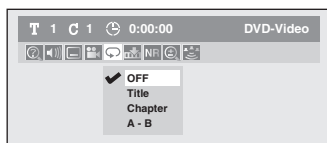

<Audio CD>

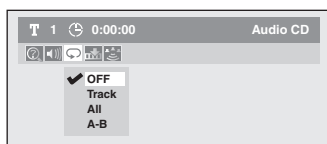

<MP3 files>

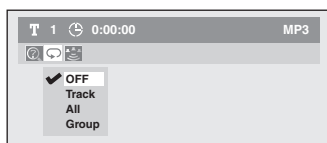

2
Using [▲ / ▼], select a desired option to repeat. Press [ENTER]. The selected repeat play will start.

Random playback



With this function, you can play a disc randomly instead of playing in the original order.

1
Press [SETUP].

2
Using [▲ / ▼], select "CD Playback Mode". Press [ENTER]. CD Playback Mode menu will appear.

Title:
The current title will be played repeatedly. (DVD only)

Chapter:
The current chapter will be played repeatedly. (DVD only)

All:
The current disc will be played repeatedly. (CD, MP3, DVD-RW (VR mode) only)

A-B:
The A-B point will be played repeatedly.
When pressing [ENTER] while A-B is highlighted, A-B repeat is set. Press [ENTER] again to decide the starting point (A). Press [ENTER] after setting point A to select the ending point (B).

Track:
The current track will be played repeatedly. (CD, MP3 only)

Group:
The current group will be played repeatedly. (MP3 only)

3
Using [▲ / ▼], select "Random Play". Press [ENTER]. Random play will start.

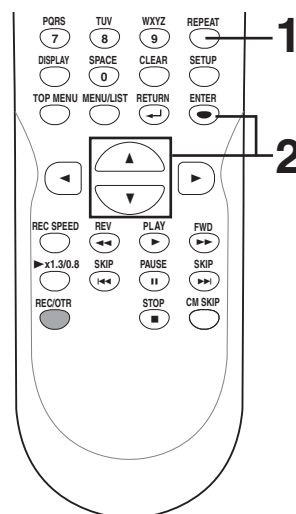

Note

- The A-B Repeat playback can only be set with in the current title (for DVDs), or current track (for Audio CDs).
- To cancel the repeat playback, select "OFF" at step 2. The repeat setting will also be cancelled when you stop playback.
- You cannot select "Group" during the random playback of MP3 files.

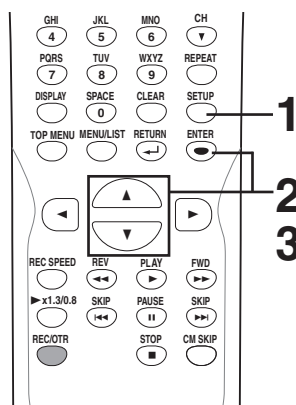

Note

- To cancel random play, press [STOP ■] twice during random play. "Play mode OFF" appears on the screen.

Playing discs

Repeat/Random/Program playback (cont'd)

Program play



You can program the disc to play in your desired order.

1
Press [SETUP].

2
Using [▲ / ▼], select "CD Playback Mode". Press [ENTER]. CD Playback Mode menu will appear.

3
Using [▲ / ▼], select "Program Play". Press [ENTER]. Program Play list will appear.

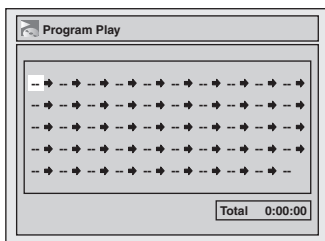

4
Using [▲ / ▼], select a desired track. Press [ENTER] or [▶]. A cursor will move to next.

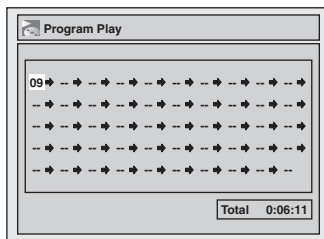

5
Press [PLAY ▶] to start program playback. Program playback will start.

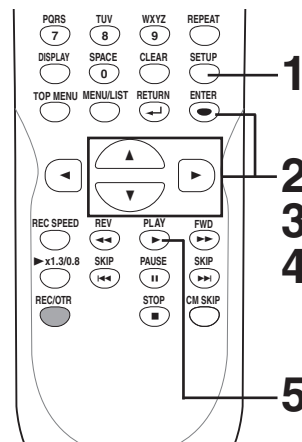

Note

- To erase tracks you selected, press [CLEAR].
- You can make program settings up to 50.
- To cancel program play, press [STOP ■] twice during program play. "Play mode OFF" appears on the screen.
- You may also select a desired track using the **Number buttons** at step 4.

Selecting the format of audio and video

You can select the format of audio and video as you prefer depending on the contents of the disc you are playing.

Switching subtitles



Many DVD-Video discs have subtitles in one or more languages – the case usually tells you which subtitle languages are available. You can switch subtitle languages anytime during playback.

1
During playback, press [DISPLAY]. The Display menu will appear.

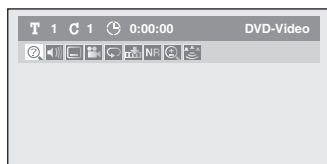

2
Using [◀ / ▶], select . Press [ENTER]. Subtitle menu will appear.

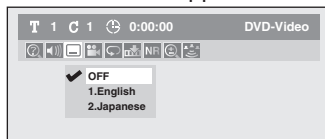

3
Using [▲ / ▼], select a desired subtitle language. Press [ENTER]. Subtitle will be displayed in the selected language. When selecting "OFF", subtitle will disappear.

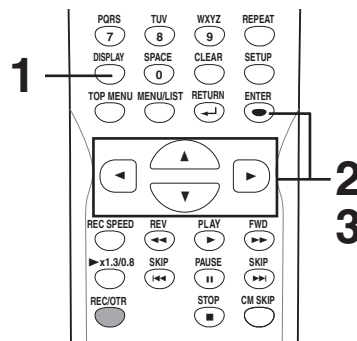

Note

- Some discs will only allow you to change the subtitle from the Disc menu. Press [TOP MENU] or [MENU / LIST] to display the Disc menu.
- If a 4-digit language code appears in the subtitle menu at step 2, refer to the "Language code" on page 75.

Playing discs

Selecting the format of audio and video (cont'd)

Switching audio soundtrack



When playing a DVD-Video disc recorded with two or more soundtracks (these are often in different languages), you can switch them during playback. On DVD-RW discs recorded in VR mode, you can switch to main (L), sub audio (R) or a mix of both (L/R). When playing Audio CDs files you can switch between stereo, just the left channel or just the right channel.

1
During playback, press [DISPLAY].
The Display menu will appear.

2
Using [◀ / ▶], select . Press [ENTER].
Audio menu will appear.

<DVD-Video>



<DVD-RW VR mode>



<Audio CD>

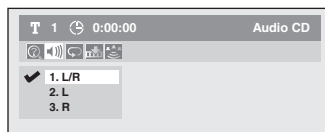

3
Using [▲ / ▼], select a desired audio soundtrack or audio channel. Press [ENTER].

<DVD-Video>
Audio soundtrack will switch.

<DVD-RW VR mode>

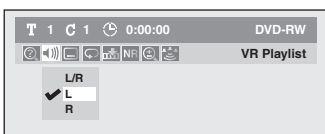

Audio channel menu will appear. Follow the step 4.

<Audio CD>
Audio channel will switch.

4
Using [▲ / ▼], select a desired audio channel. Press [ENTER].
Audio channel will switch.

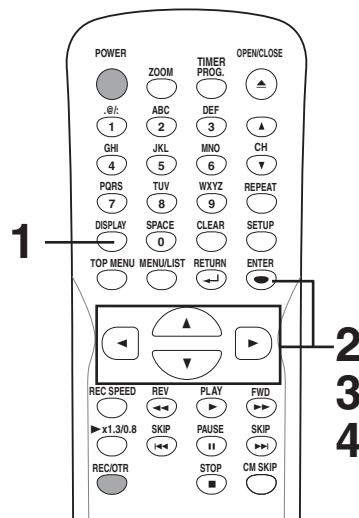

Note

- Some discs will only allow you to change the soundtrack from the Disc menu. Press [TOP MENU] or [MENU / LIST] to display the Disc menu.
- On DVD-RW discs recorded in VR mode that may have both a main and a sub audio channel, you can switch to main (L), sub audio (R) or a mix of both (L/R).
- This unit CANNOT record in both stereo and SAP (Secondary Audio Program) at the same time.

Switching virtual surround system



You can enjoy stereophonic virtual space through your exciting 2 channel stereo system.

1
During playback, press [DISPLAY].
The Display menu will appear.



2
Using [◀ / ▶], select . Press [ENTER].
Virtual Surround menu will appear.

<DVD-Video>

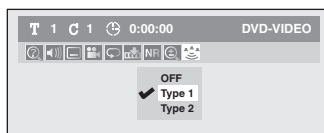

<DVD-RW VR mode>

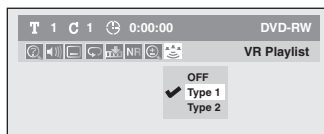

<Audio CD, MP3 files>

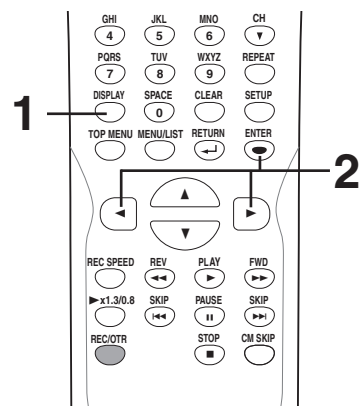
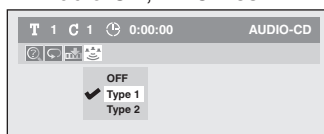

Note

- Select Virtual Surround OFF in a case sound is distorted.
- The setting will be kept OFF when the unit is turned off.

Playing discs

Selecting the format of audio and video (cont'd)

3

Using [▲ / ▼], select "OFF", "Type1" or "Type2". Press [ENTER].

- OFF: no effect
- Type1: Natural effect
- Type2: Emphasised effect

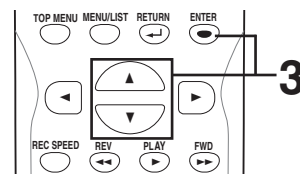

Switching camera angles



Some DVD-Video discs feature scenes shot from two or more angles, check the case for details: it should be marked with Angle icon if it contains multi-angle scenes.

1

During playback, press [DISPLAY].

The Display menu will appear.

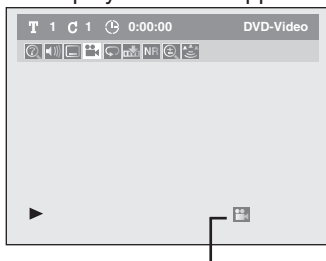

Angle icon appears when a switching camera angle is available.

2

Using [◀ / ▶], select . Press [ENTER].

Angle will switch each time you press [ENTER].

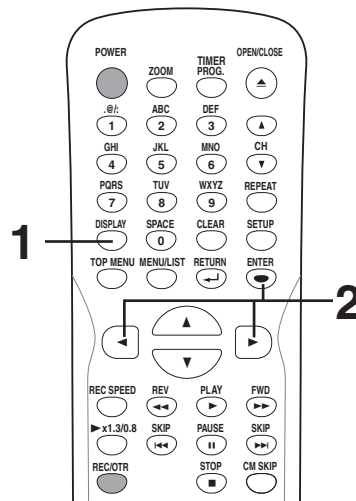

Note

Angle icon does not appear on the screen in a case you have selected Angle as "OFF" in the Display setting. Refer to pages 67-68.

Reducing block noise



1

During playback, press [DISPLAY].

The Display menu will appear.

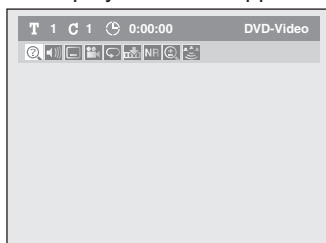

2

Using [◀ / ▶], select NR. Press [ENTER].

Noise Reduction menu will appear.

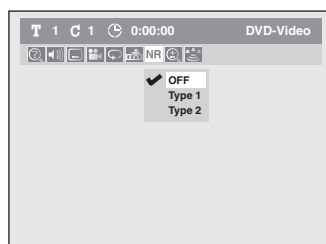

3

Using [▲ / ▼], select a desired option. Press [ENTER].

Your setting will be activated.

This function reduces noise in the playback picture. When playing back discs recorded in long time mode such as SLP or SEP mode, select "Type 1" or "Type 2". ("Type 2" is more effective.) When playing back discs with a few noises such as DVD-Video discs, select "OFF".

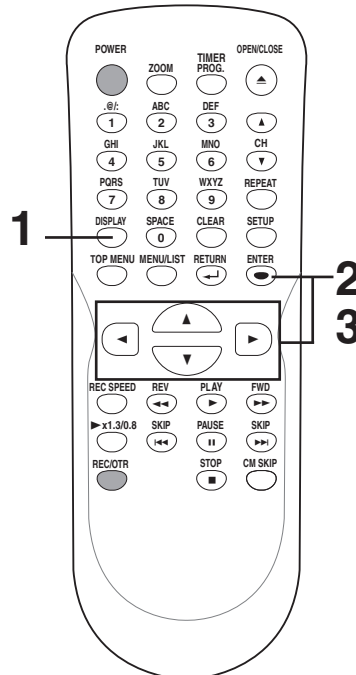

Guide to a title list

Title list allows you to check the titles recorded on the disc easily. You can choose a title to play from this screen and easily edit the titles as you prefer.

Press [TOP MENU].

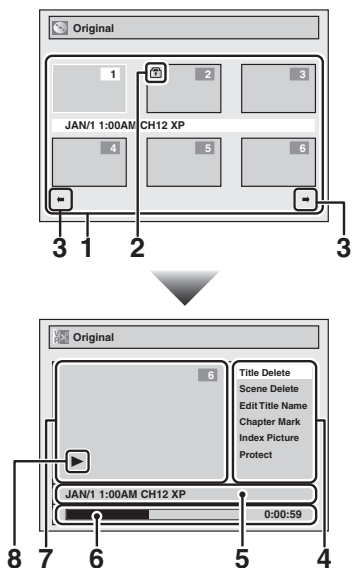

1. Titles recorded on the disc can be selected to edit or play by pressing [ENTER] with the cursor on the title.
2. The key icon, which appears when the title has been protected. (Original titles only)
3. The arrow icon, which means the Title list includes a next or a previous page. Press [◀ / ▶] by following direction of the icon.
4. The menus in here for editing titles as you prefer. The available menus depend on the disc type and the format type. An item which is not available is grayed.
5. The details of the title, which can be changed to the title name you will edit.
6. Time status bar of the title.
Time status will be held even after exiting the edit mode, and you can resume playback from that point.
7. The selected title thumbnail from the title list.
8. Playback status of the current disc.

Editing discs in Video mode

You can edit discs in Video mode for the following items. Be sure that once you edit titles, they will not remain as original.

- Deleting titles (Refer to page 51)
- Putting names on titles (Refer to page 52)
- Setting or clearing chapter markers (Refer to page 53)

Note

- Once a disc is finalized, editing the disc or recording to the disc will not be available. (Except DVD-RW discs in VR mode.)
- A Playlist is not available with the DVD-R discs and DVD-RW discs in Video mode.

Editing discs in VR mode

For discs in VR mode, you can edit from "Original" menu or "Playlist" menu, which is created from the original.

Editing Original titles

The following items can be used to edit the Original titles.

- Deleting titles (Refer to page 54)
- Setting titles to protect (Refer to page 55)
- Releasing titles from protecting (Refer to page 56)

Editing Playlists

You can create a Playlist from Original titles, so that you can edit as you prefer without losing Original titles.

The following items you can edit with a playlist.

- Deleting titles (Refer to page 57)
- Dividing a title (Refer to page 58)
- Combining titles (Refer to page 59)
- Adding titles to a Playlist (Refer to page 60)
- Deleting a Playlist (Refer to page 60)

Editing Original titles / Playlists

The following items can be used to edit both the Original titles and the Playlists.

- Deleting parts of titles (Refer to page 61)
- Putting names on titles (Refer to page 62)
- Setting or clearing chapter markers (Refer to page 63)
- Setting pictures for thumbnails (Refer to page 64)

Note

- Original titles once edited will not remain as recorded originally. When you want to leave the original as it is, edit the Playlist as you prefer.

Once all editings are made, press [RETURN ←] in several times to exit the editing mode. "Writing to Disc" appears momentarily. This is true also when opening the disc tray, pressing [POWER] to turn the unit off.

Deleting titles



You can delete titles which you do not need anymore.

Be advised that the titles once deleted cannot be brought back to the disc.

When the last title in the title list in Video mode is deleted, the disc space to record will be increased. For DVD-R disc, the disc space to record will not be changed.

1
Press [TOP MENU].
Title List will appear.

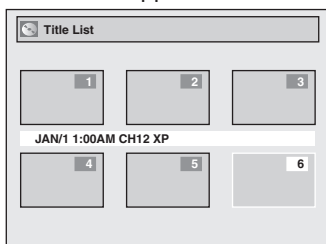

2
Using [▲ / ▼ / ◀ / ▶], select the desired title. Press [ENTER].
Option window will appear.

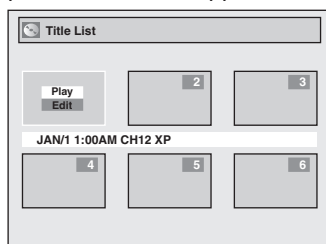

3
Using [▲ / ▼], select "Edit".
Press [ENTER].
Edit menu will appear.

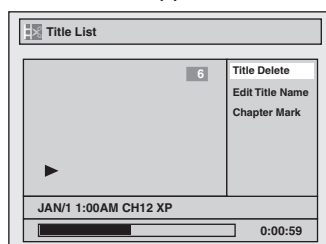

You cannot select "Chapter Mark" when a DVD-R disc is inserted into the unit.

"Chapter Mark" does not work on title less than 5 minutes.

4
Using [▲ / ▼], select "Title Delete". Press [ENTER].
Confirm window will appear.

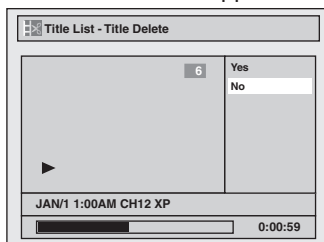

5
Using [▲ / ▼], select "Yes".
Press [ENTER].
After that, "Are you sure?" will appear, so that select "Yes" with [▲ / ▼] and then press [ENTER].

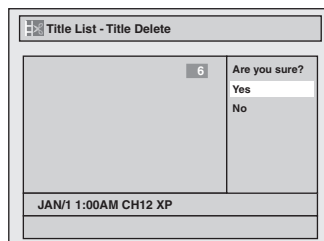

Title will be deleted.

6
Press [TOP MENU], [RETURN ↵] or [STOP ■] to exit.
Data will be written onto the disc momentarily.

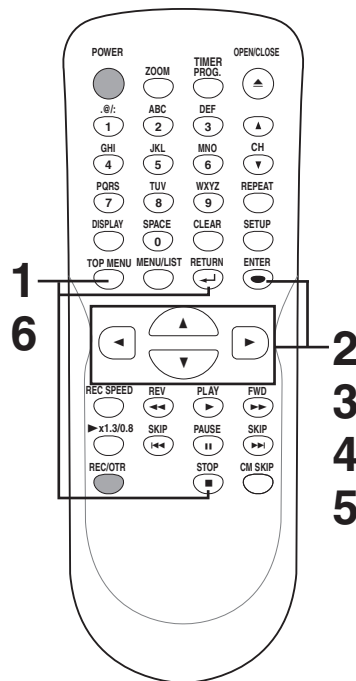
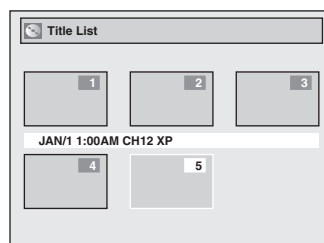

Editing

Editing discs in Video mode (cont'd)

Putting names on titles



You can put title names on the titles and change the names from this menu.

The names you put on the titles will be displayed on a Title List.

1

Follow the steps 1 to 3 on page 51 to display the Edit menu.

Using [▲ / ▼], select “Edit Title Name”. Press [ENTER].

A window for entering a title name will appear.

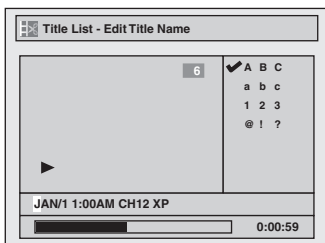

2

To enter a title name, follow the steps of “Guide to edit title name” on this page.

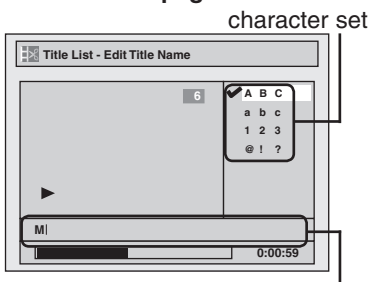

area for entering title names

When you finish entering a title name, press [ENTER]. Confirm window will appear.

3

Using [▲ / ▼], select “Yes”. Press [ENTER].

The name you entered will be activated for the title.

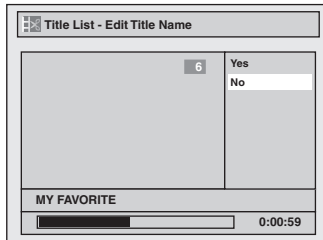

4

Press [RETURN ↵] and then [TOP MENU], [RETURN ↵] or [STOP ■] to exit.

Data will be written onto the disc momentarily.

This operation may take a while to be completed.

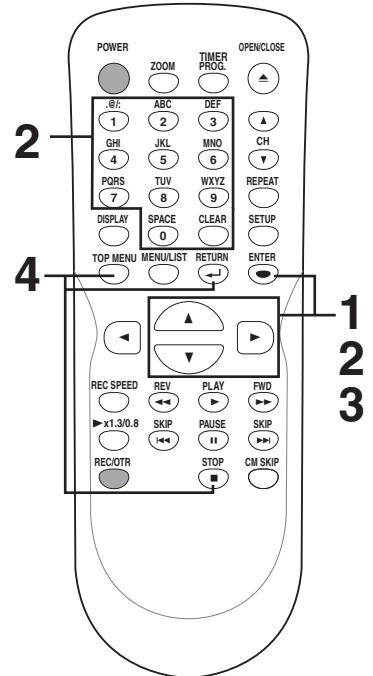

[Guide to edit title name]

[Step1]: Select a desired character set using [▲/▼], then press [ENTER].

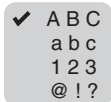

[Step2]: Follow the list below, press the **Number buttons** repeatedly until the desired letter appears. e.g. character set : **A B C**

Select Press	ABC	abc	123	@!?
0	<space>	<space>	0	<space>
1	(*1)	(*1)	1	!"#\$%&'()* *+,-./:;<=> ?@[]^_`{ }
2	ABC	abc	2	(*2)
3	DEF	def	3	(*2)
4	GHI	ghi	4	(*2)
5	JKL	jkl	5	(*2)
6	MNO	mno	6	(*2)
7	PQRS	pqrs	7	(*2)
8	TUV	tuv	8	(*2)
9	WXYZ	wxyz	9	(*2)

Note: Undefined letters in a title name are shown by “*”. If you delete them, adjoining letters may change to “*” or other.

*1 Press (1), character set will be changed to the “ @!?” mode automatically.

*2 Press (2) to (9), character set will be changed to the previous input mode automatically.

- To delete letters, press [CLEAR] repeatedly. Holding [CLEAR] to delete all letters.
- To go on to the next entering area for letters, press [▶].
- You can enter up to 30 letters.

Setting or clearing chapter markers



You can put chapter markers in each title. Once a chapter is marked, you can use it for the chapter search feature.

You can set chapter markers at a specified time you selected for titles with more than 5 minutes.

1 Follow the steps 1 to 3 on page 51 to display the Edit menu.

Using [▲ / ▼], select “Chapter Mark”. Press [ENTER]. Option window will appear.

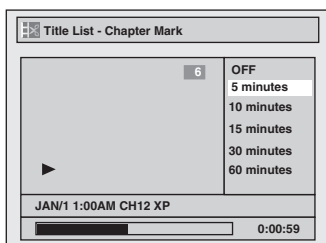

2 Using [▲ / ▼], select desired time period. Press [ENTER]. Confirm window will appear.

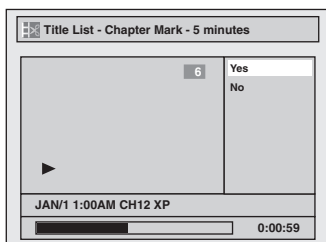

3 Using [▲ / ▼], select “Yes”. Press [ENTER]. The marker will be added or deleting.

This operation may take a while to be completed.

4 After this operation is completed, press [RETURN ↵] and then [TOP MENU], [RETURN ↵] or [STOP ■] to exit. Data will be written onto the disc momentarily.

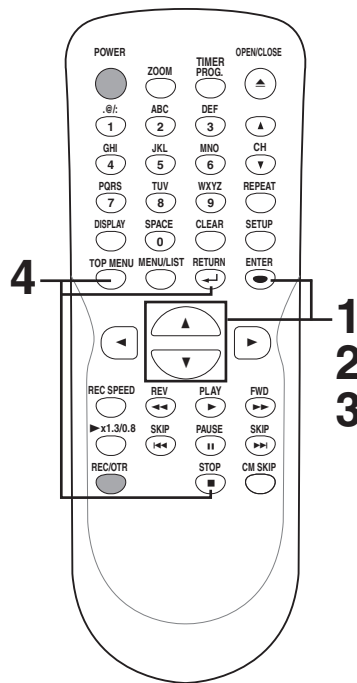

4

1
2
3

Note

- You cannot select a time for putting markers beyond a length of a title.
- The length of chapters may be slightly longer or shorter than the one specified at the step 2.

Editing

Editing discs in VR mode (Original)

Deleting titles



When a title is deleted from an Original list in VR mode, the disc space to record will be increased. Be advised that the titles once deleted cannot be brought back to the disc.

1

Press [TOP MENU], and then press [MENU / LIST] to change "Playlist" to "Original". Original list will appear.

2

Using [▲ / ▼ / ◀ / ▶], select the desired title. Press [ENTER]. Option window will appear.

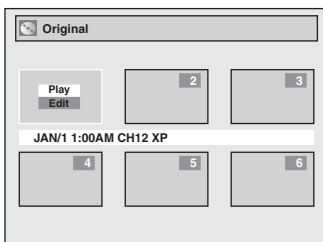

3

Using [▲ / ▼], select "Edit". Press [ENTER]. Original menu will appear.

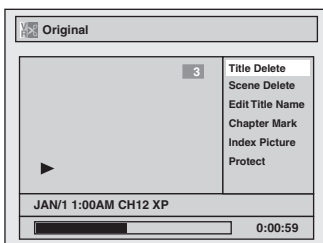

4

Using [▲ / ▼], select "Title Delete". Press [ENTER]. Confirm window will appear.

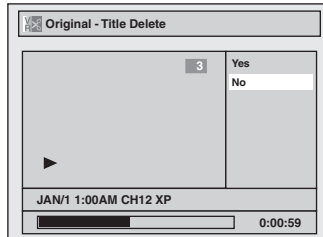

5

Using [▲ / ▼], select "Yes". Press [ENTER]. After that, "Are you sure?" will appear, so that select "Yes" with [▲ / ▼] and then press [ENTER].

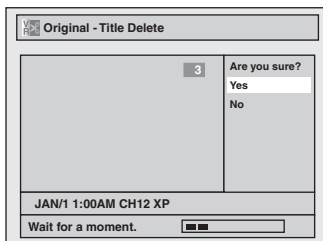

Title will be deleted.

This operation may take a while to be completed.

6

After this operation is completed, press [TOP MENU], [RETURN ↵] or [STOP ■] to exit.

Data will be written onto the disc momentarily.

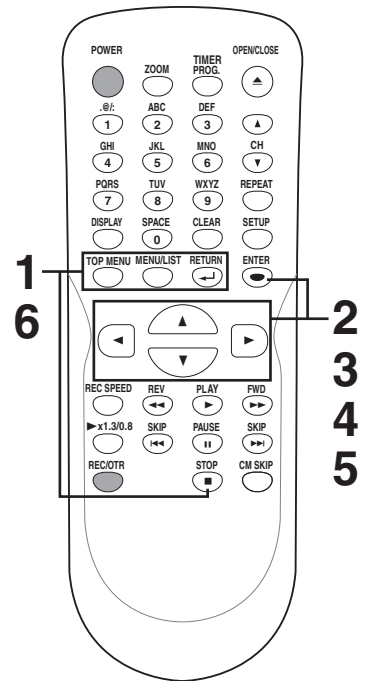

Setting titles to protect



To prevent accidental editing, or erasing the titles, you can protect them from the Original menu.

1

Follow the steps 1 to 3 on page 54 to display the Original menu.

Using [▲ / ▼], select "Protect". Press [ENTER].

Option window will appear.

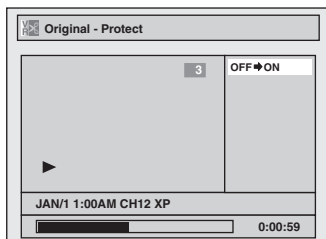

2

Confirm the indication "OFF → ON". Press [ENTER].

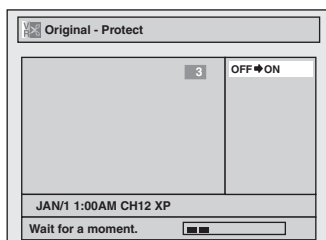

This operation may take a while to be completed.

The key icon will appear on the title in the Original list.

3

After this operation is completed, press [RETURN ↵] and then [TOP MENU], [RETURN ↵] or [STOP ■] to exit.

Data will be written onto the disc momentarily.

To protect a whole disc (DVD-RW VR mode Only):

Select "Disc Protect" from the Disc menu, then select "Yes".

Refer to "Setting a disc to protect" on page 34.

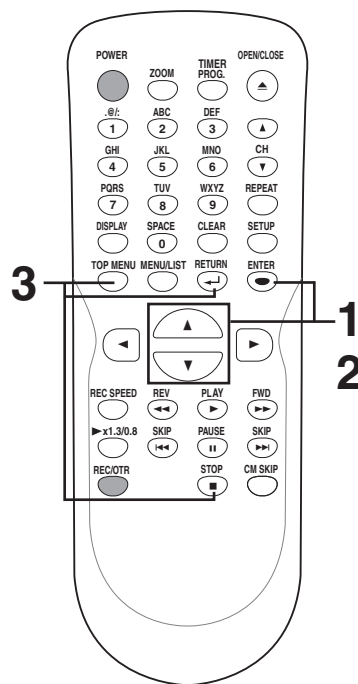

Editing

Editing discs in VR mode (Original) (cont'd)

Releasing titles from protecting



You are allowed to release the titles protecting feature once protected.

1

Follow the steps 1 to 3 on page 54 to display the Original menu.

Using [▲ / ▼], select "Protect".

Press [ENTER].

Option window will appear.

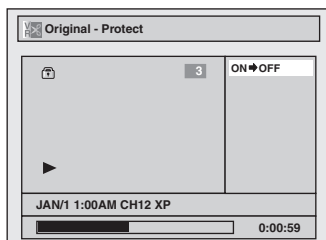

2

Confirm the indication

"ON → OFF". Press [ENTER].

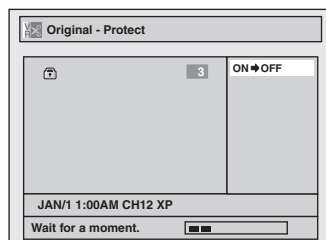

This operation may take a while to be completed.

The key icon will disappear from the title in the Original list.

3

After this operation is completed, press [RETURN ↵] and then [TOP MENU], [RETURN ↵] or [STOP ■] to exit.

Data will be written onto the disc momentarily.

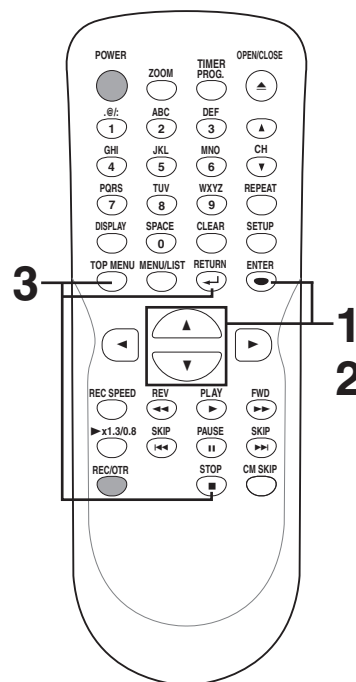

Deleting titles



In VR mode, even when a title is deleted from a Playlist, the original title will remain in an Original list. The disc space to record will not be increased.

1
Press [TOP MENU], and then press [MENU / LIST] to change "Original" to "Playlist". Playlist will appear.

2
Using [▲ / ▼ / ◀ / ▶], select the desired title. Press [ENTER]. Option window will appear.

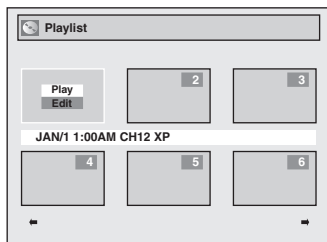

3
Using [▲ / ▼], select "Edit". Press [ENTER]. Playlist menu will appear.

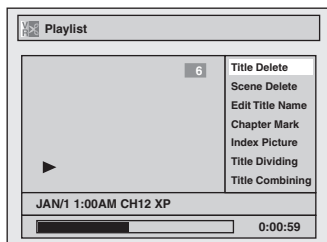

4
Using [▲ / ▼], select "Title Delete". Press [ENTER]. Confirm window will appear.

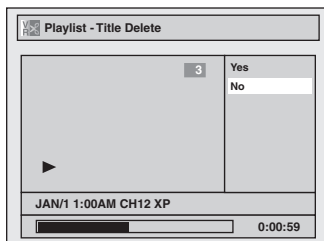

5
Using [▲ / ▼], select "Yes". Press [ENTER]. After that, "Are you sure?" will appear, so that select "Yes" with [▲ / ▼] and then press [ENTER].

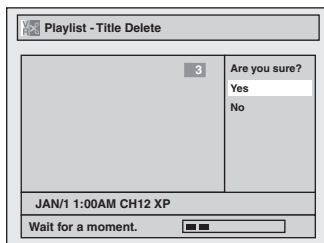

Title will be deleted.

This operation may take a while to be completed.

6
After this operation is completed, press [TOP MENU], [RETURN ←] or [STOP ■] to exit. Data will be written onto the disc momentarily.

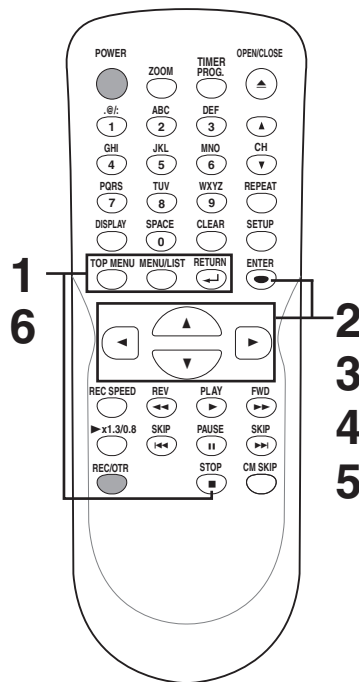

Editing

Editing discs in VR mode (Playlist) (cont'd)

Dividing a title



You can divide a title into two new titles.

1

Follow the steps 1 to 3 on page 57 to display the Playlist menu.

Using [▲ / ▼], select "Title Dividing". Use [SKIP ◀◀ / ▶▶], [REV ◀◀], [FWD ▶▶], [PLAY ▶] and [PAUSE II] to decide the point at which you will divide the title.

Press [ENTER].

Confirm window will appear.

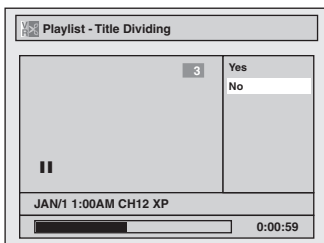

2

Using [▲ / ▼], select "Yes".

Press [ENTER].

The title will be divided into two new titles.

Both title names are identical, and index pictures are reset to first scene at this point.

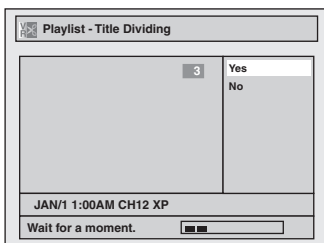

This operation may take a while to be completed.

3

After this operation is completed, press [TOP MENU], [RETURN ↵] or [STOP ■] to exit.

Data will be written onto the disc momentarily.

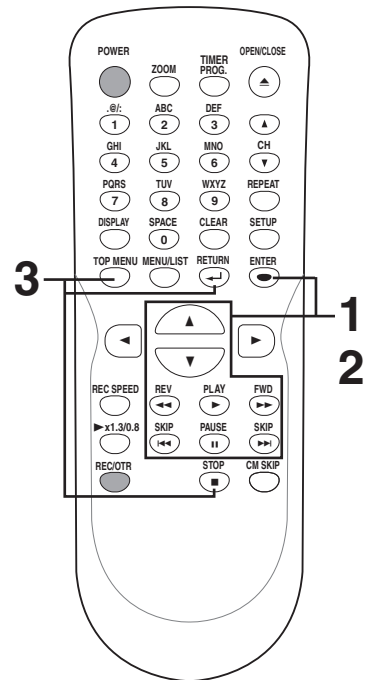

Note

- You cannot divide a title of the disc on which the number of recording title comes up to the maximum (99), and the number of recording chapter comes up to the maximum (999).

Combining titles



You can combine two titles into a single title.

1

Follow the steps 1 to 3 on page 57 to display the Playlist menu.

Using [▲ / ▼], select "Title Combining". Press [ENTER].

Title Combining setting window will appear.

Selected title grays out, and the frame of the next title becomes yellow.

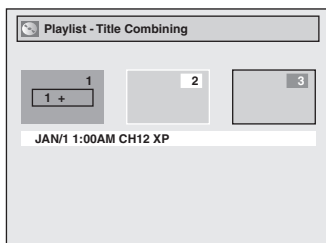

2

Using [▲ / ▼ / ◀ / ▶], select another title to combine. Press [ENTER].

Confirm window will appear.

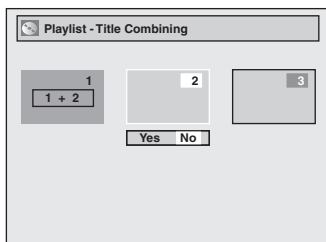

3

Using [◀ / ▶], select "Yes". Press [ENTER].

Two titles will combine into a single title.

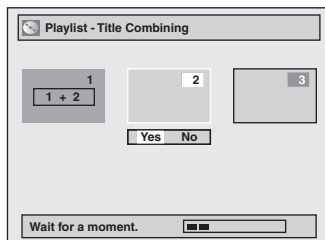

This operation may take a while to be completed.

4

After this operation is completed, press [TOP MENU], [RETURN ←] or [STOP ■] to exit.

Data will be written onto the disc momentarily.

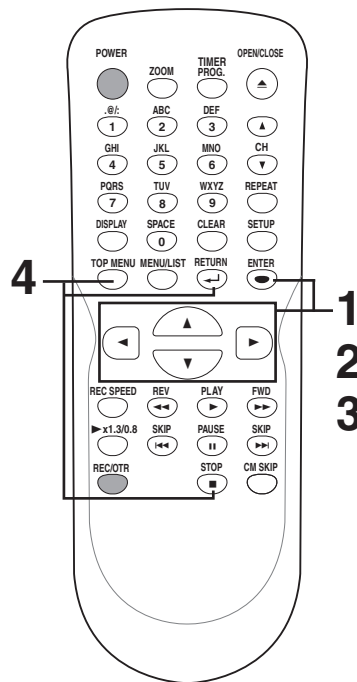

Note

- You cannot combine the same titles into a single title.
- If one of two titles in the original is deleted, the combined new title will be deleted automatically.
- Selection order for the combining is affected in the combined new title.

Editing

Editing discs in VR mode (Playlist) (cont'd)

Adding titles to a Playlist



You can add or delete a title in the Playlist as you prefer.
You can add titles to a Playlist up to 99.

1

Follow the step 1 on page 57 to display the Playlist.
Next to the final title, "Add New Title" "Delete Playlist" menu is shown.
Using [▲ / ▼], select "Add New Title". Press [ENTER].

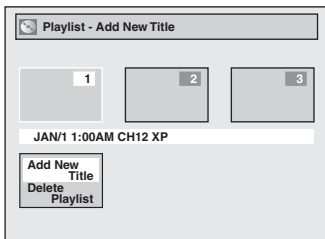

The added title will appear on the next to the selected title.

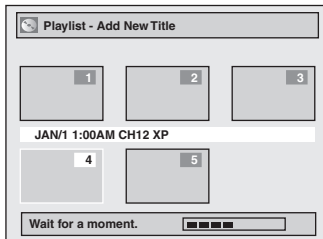

This operation may take a while to be completed.

3

After this operation is completed, press [TOP MENU], [RETURN ↵] or [STOP ■] to exit.
Data will be written onto the disc momentarily.

To delete a title from Playlist, refer to "Deleting titles" on page 57.
To delete a Playlist, refer to "Deleting a Playlist" on this page.

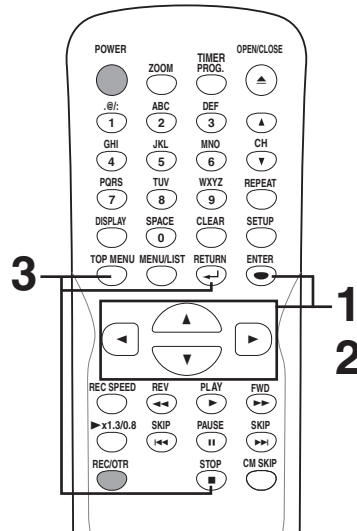

Note

- When a Playlist contains 99 titles or more, or 999 chapters or more, "Add New Title" cannot be selected.

2

Using [▲ / ▼ / ◀ / ▶], select a desired title. Press [ENTER].

Deleting a Playlist



A Playlist can be deleted if no longer needed.

1

Follow the step 1 on page 57 to display the Playlist.
Next to the final title, "Add New Title" "Delete Playlist" menu is shown.
Using [▲ / ▼ / ◀ / ▶], select "Delete Playlist". Press [ENTER].
Confirm window will appear.

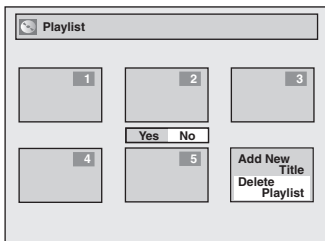

Final confirm window will appear.

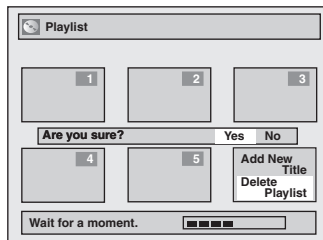

3

Using [◀ / ▶], select "Yes". Press [ENTER].
A Playlist will be erased.

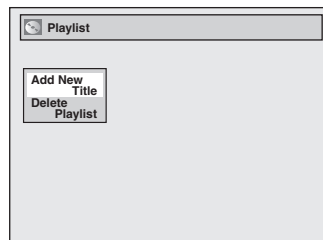

This operation may take a while to be completed.

4

After this operation is completed, press [TOP MENU], [RETURN ↵] or [STOP ■] to exit.
Data will be written onto the disc momentarily.

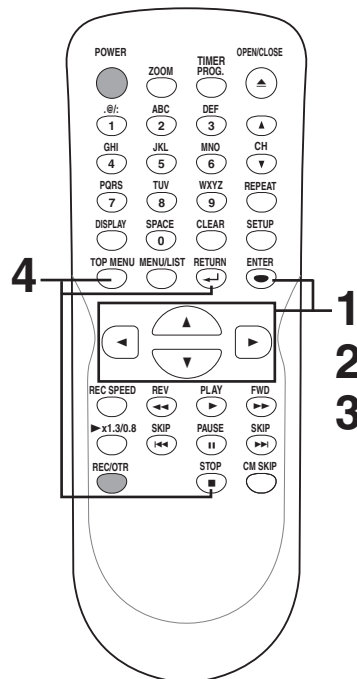

Note

- Deleting a Playlist will not increase the available recording time on disc.

Editing discs in VR mode (Original / Playlist)

Deleting parts of titles



You can delete a specific part of a title.

Even when a title is deleted from the Playlist, the original title will remain.

The disc space to record will not be increased.

1

Press [TOP MENU], and then press [MENU LIST] to select "Original" or "Playlist".

2

Using [▲ / ▼ / ◀ / ▶], select the desired title. Press [ENTER]. Option window will appear.

<Playlist>

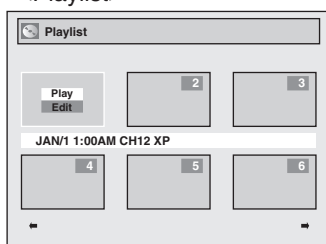

3

Using [▲ / ▼], select "Edit". Press [ENTER].

Playlist menu will appear.

<Playlist>

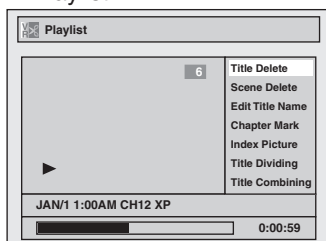

4

Using [▲ / ▼], select "Scene Delete". Press [ENTER].

Option window will appear.

<Playlist>

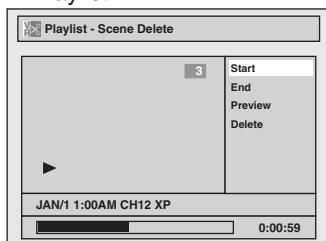

5

Use [SKIP ◀◀ / ▶▶], [REV ◀◀], [FWD ▶▶], [PLAY ▶] and [PAUSE ||] to decide the start point, then press [ENTER]. Then use [SKIP ◀◀ / ▶▶], [REV ◀◀], [FWD ▶▶], [PLAY ▶] and [PAUSE ||] again to move to the end point, and press [ENTER].

A cursor will move to "Preview". The bar at the bottom of the screen indicates the total and the elapsed time of the title, and the area selected for deletion will be indicated in red.

Press [ENTER] again to start the preview.

You can check the result of deletion by "Preview".

Start point End point

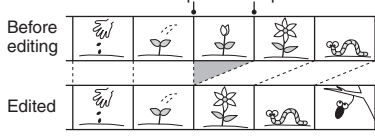

6

Using [▲ / ▼], select "Delete". Press [ENTER].

Confirm window will appear.

<Playlist>

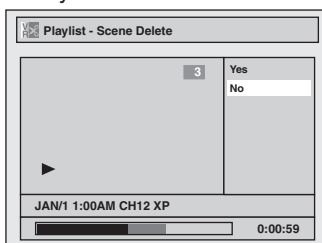

7

Using [▲ / ▼], select "Yes".

Press [ENTER].

After that, "Are you sure?" will appear, so that select "Yes" with [▲ / ▼] and then press [ENTER].

<Playlist>

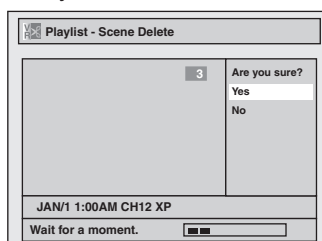

Part of a title will be deleted.

This operation may take a while to be completed.

8

After this operation is completed, press [RETURN ↵] and then [TOP MENU], [RETURN ↵] or [STOP ■] to exit.

Data will be written onto the disc momentarily.

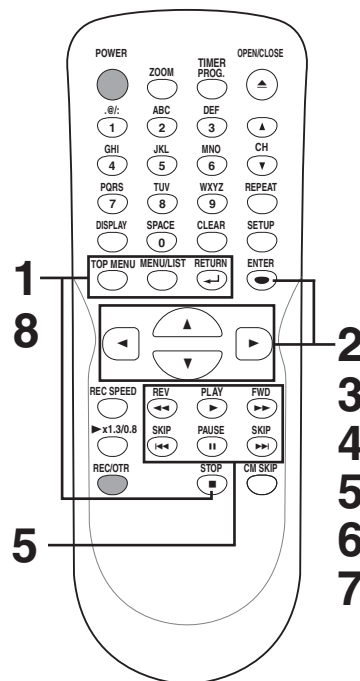

1

8

8

3

4

5

5

7

7

Note

- You cannot select "Scene Delete" when the number of chapter markers is more than 900.

Editing

Editing discs in VR mode (Original / Playlist) (cont'd)

Putting names on titles



You can put title names on the titles and change the names from this menu.

The names you put on the titles will be displayed on a Title List.

1

Follow the steps 1 to 3 on page 61 to select "Original" or "Playlist".

2

Using [▲ / ▼], select "Edit Title Name". Press [ENTER].

A window for entering a title name will appear.

<Playlist>

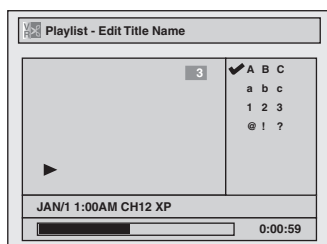

3

To enter a title name, follow the steps of "Guide to edit title name" on this page.

character set

<Playlist>

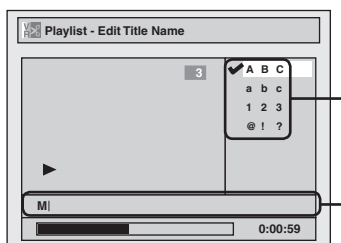

area for entering title names

When you finish entering a title name, press [ENTER].

Confirm window will appear.

4

Using [▲ / ▼], select "Yes". Press [ENTER].

The name you entered will be activated for the title.

<Playlist>



5

Press [RETURN ↵] and then [TOP MENU], [RETURN ↵] or [STOP ■] to exit.

Data will be written onto the disc momentarily.

This operation may take a while to be completed.

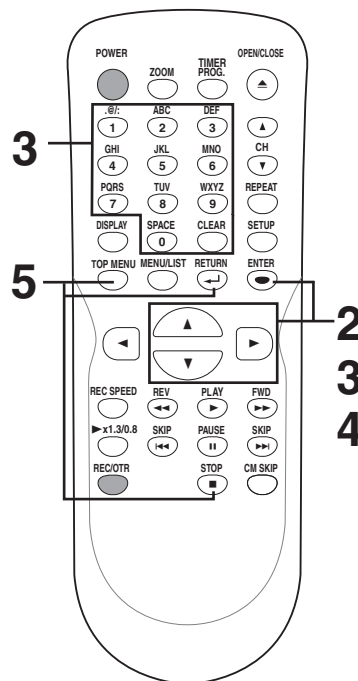

[Guide to edit title name]

[Step1]: Select a desired character set using [▲/▼], then press [ENTER].

✓ A B C
a b c
1 2 3
@ ! ?

[Step2]: Follow the list below, press the **Number** buttons repeatedly until the desired letter appears.
e.g. character set : A B C

Select Press	ABC	abc	123	@ ! ?
0	<space>	<space>	0	<space>
1	(*1)	(*1)	1	! " # \$ % & ' () * + , - . / : ; < = > ? @ [] ^ _ { }
2	ABC	abc	2	(*2)
3	DEF	def	3	(*2)
4	GHI	ghi	4	(*2)
5	JKL	jkl	5	(*2)
6	MNO	mno	6	(*2)
7	PQRS	pqrs	7	(*2)
8	TUV	tuv	8	(*2)
9	WXYZ	wxyz	9	(*2)

Note:
Undefined letters in a title name are shown by "*". If you delete them, adjoining letters may change to "*" or other.

*1 Press 1, character set will be changed to the "@ ! ?" mode automatically.

*2 Press 2 to 9, character set will be changed to the previous input mode automatically.

- To delete letters, press [CLEAR] repeatedly. Holding [CLEAR] to delete all letters.
- To go on to the next entering area for letters, press [▶].
- You can enter up to 30 letters.

Setting or clearing chapter markers



You can put chapter markers in each title. Once a chapter is marked, you can use it for the chapter search feature.

You can put a chapter marker anywhere you want.

When the number of chapter markers in the Playlist comes to 999 in total, you cannot add any more chapter markers.

1 Follow the steps 1 to 3 on page 61 to select "Original" or "Playlist".

2 Using [▲ / ▼], select "Chapter Mark". Press [ENTER]. Option window will appear.

<Playlist>

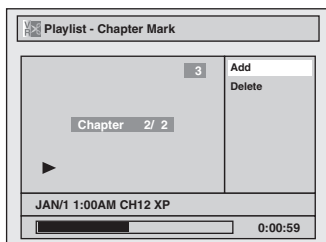

3 Use [SKIP ◀◀ / ▶▶], [REV ◀◀], [FWD ▶▶], [PLAY ▶] and [PAUSE II] to decide the point at which you will create a new chapter marker. Or, use [SKIP ◀◀ / ▶▶] to decide a chapter marker that you will delete. Select "Add" or "Delete" accordingly using [▲ / ▼]. Press [ENTER]. Confirm window will appear.

<Playlist :Add>

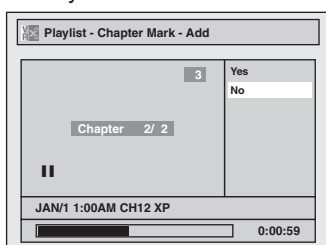

<Playlist :Delete>

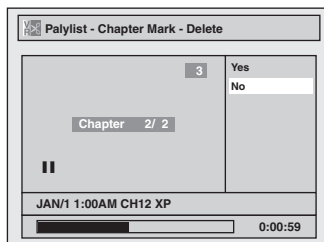

- You cannot delete the first chapter of each title.

4 Using [▲ / ▼], select "Yes". Press [ENTER].

When you select "Add" at step 3, a new chapter marker will be created at the point you have decided.

<Playlist :Add>

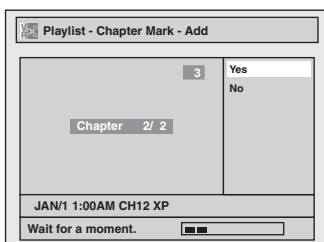

This operation may take a while to be completed.

When you select "Delete" at step 3, the chapter marker you have selected will be deleted.

<Playlist :Delete>

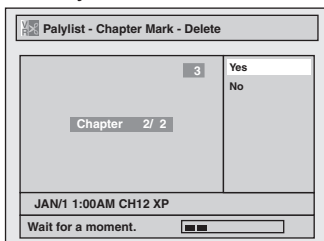

This operation may take a while to be completed.

5 After this operation is completed, press [RETURN ↵] twice and then [TOP MENU], [RETURN ↵] or [STOP ■] to exit.

Data will be written onto the disc momentarily.

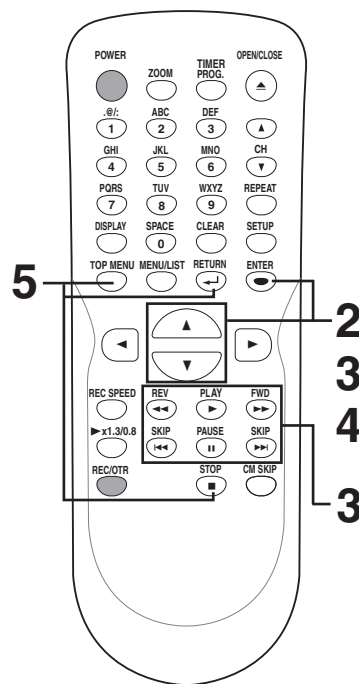

Editing

Editing discs in VR mode (Original / Playlist) (cont'd)

Setting pictures for thumbnails



You can set a picture to each title for a thumbnail. It helps you to remember the contents of the title you are playing. The beginning picture has been selected as the default.

1

Follow the steps 1 to 3 on page 61 to select "Original" or "Playlist".

2

Use [SKIP <<< / >>>], [REV <<], [FWD >>], [PLAY >] and [PAUSE ||] to decide the picture you want to select as a thumbnail. Using [▲ / ▼], select "Index Picture". Press [ENTER]. Confirm window will appear.

<Playlist>

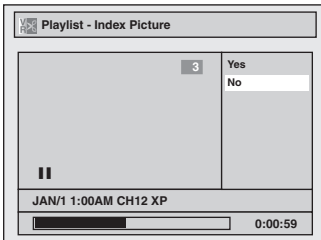

3

Using [▲ / ▼], select "Yes". Press [ENTER].

A picture for thumbnail will be set.

<Playlist>

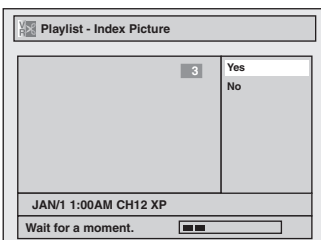

This operation may take a while to be completed.

4

After this operation is completed, press [RETURN ↵] and then [TOP MENU], [RETURN ↵] or [STOP ■] to exit.

Data will be written onto the disc momentarily.

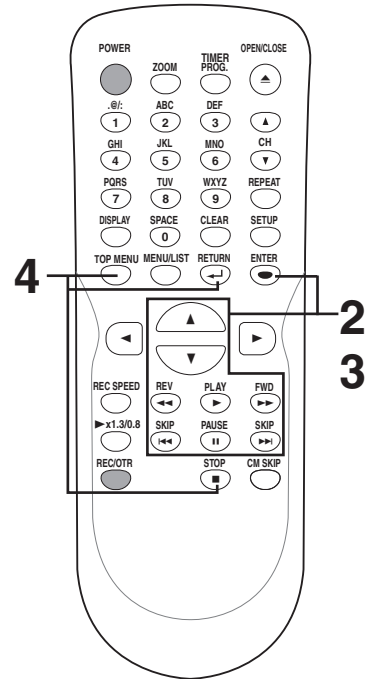

Note

- If a selected picture for a thumbnail is deleted by deleting a part of a title, a default picture will be selected.

Changing the Setup menu

Tour of the Setup menu

The following table is the contents which you can set and the default settings. Refer to the following table for useful operation.

Setup	Items (highlight is the default)	Contents
1. Language setting → Pages 66-67	Disc Menu Language	English French Spanish ⋮
	Audio Language	Original English French ⋮
	Subtitle Language	OFF English French ⋮
2. Display setting → Pages 67-68	OSD Language	English Français Español
	Angle Icon	ON OFF
	Screen Saver	OFF 5 minutes 10 minutes ⋮
	FL Dimmer	Auto Bright Dark
3. Audio setting → Pages 68-70	Digital Out	PCM 48kHz 96kHz
		Dolby Digital PCM Stream
	Dynamic Range Control	ON OFF
4. Parental setting → Pages 70-71	Parental Lock	ALL level 8 to 1
	(Change password)	Enter the current four-digit password

Note

- If you change the setting in the Setup menu, the information of contents stays on even when the power is switched off.
- An item which is not currently available is grayed in Setting menus.

Changing the Setup menu

Language setting

Press [STOP ■] if you are playing a disc.

1

Press [SETUP].

2

Using [▲ / ▼], select "Playback". Press [ENTER].

Playback menu will appear.

3

Using [▲ / ▼], select "Language". Press [ENTER].

Language menu will appear.

4

Using [▲ / ▼], select a desired item. Press [ENTER].

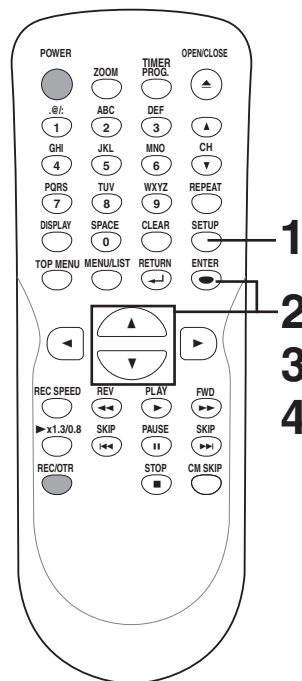

Disc Menu Language (Default : English)

Set the language for Disc Menu.

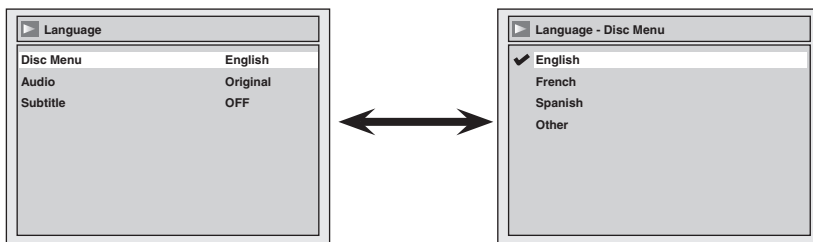

- Using [▲ / ▼], select a setting. Press [ENTER]. Your setting will be activated.

Audio Language (Default : Original)

Set the Audio language.

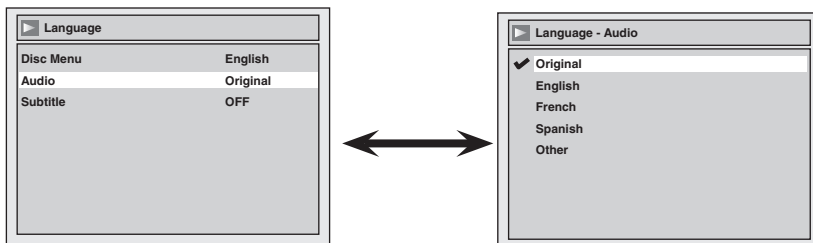

- Using [▲ / ▼], select a setting. Press [ENTER]. Your setting will be activated.
- When Original is selected, the audio language will be in the disc's default language.

Changing the Setup menu

Language setting (cont'd)

Subtitle Language (Default : OFF)

Set the Subtitle language.

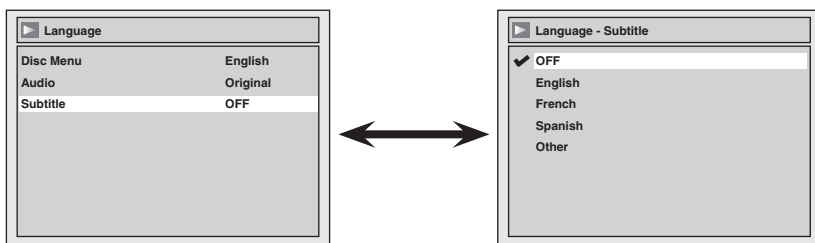

- Using [▲ / ▼], select a setting. Press [ENTER]. Your setting will be activated.

If "Other" is selected, press 4-digit code using the Number buttons.

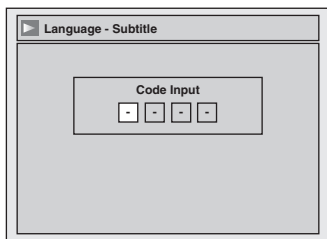

- When you finish entering the code, press [ENTER]. Refer to "Language code" on page 75.

Note

- Only the languages supported by the disc can be selected.
- Audio Language setting may not be available to some discs.
- You can change or switch off the subtitles on a DVD disc also from the Disc menu if it is available.
- Press [CLEAR] or [◀] to erase numbers entered incorrectly.

5

Press [SETUP] to exit.

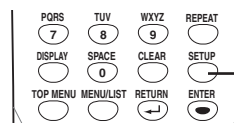

5

Display setting

Press [STOP ■] if you are playing a disc.

1

Press [SETUP].

2

Using [▲ / ▼], select "Display". Press [ENTER].

Display menu will appear.

3

Using [▲ / ▼], select a desired item. Press [ENTER].

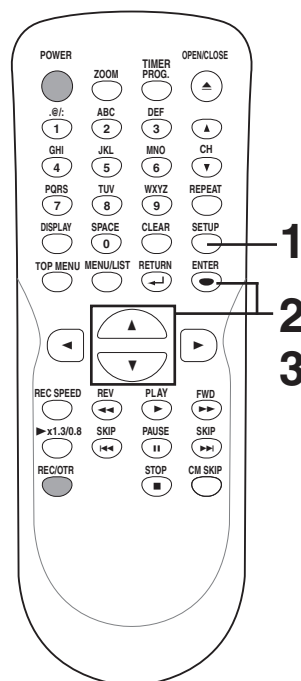

Instructions continue on the next page.

Changing the Setup menu

Display setting (cont'd)

OSD Language (Default : English)

Set the language for OSD.

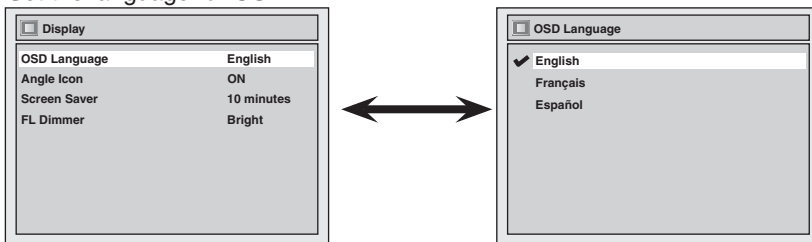

- Using **[▲ / ▼]**, select a setting. Press **[ENTER]**. Your setting will be activated.

Angle Icon (Default : ON)

Set to ON or OFF.

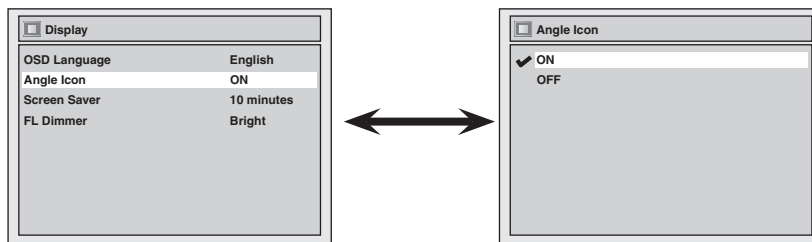

- Using **[▲ / ▼]**, select a setting. Press **[ENTER]**. Your setting will be activated.

Screen Saver (Default : 10 minutes)

Set the time to work the screen saver function on the screen.

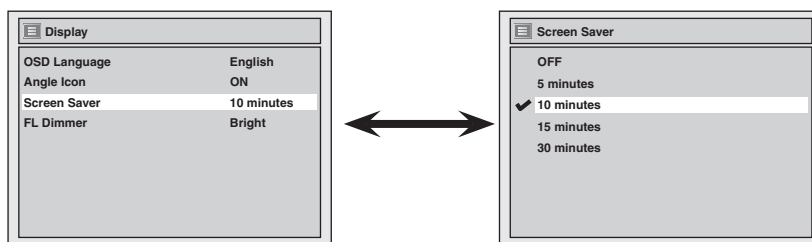

- Using **[▲ / ▼]**, select a setting. Press **[ENTER]**. Your setting will be activated.

FL Dimmer (Default : Bright)

Set the brightness of front panel display.

You can choose one among "Auto", "Bright" and "Dark".

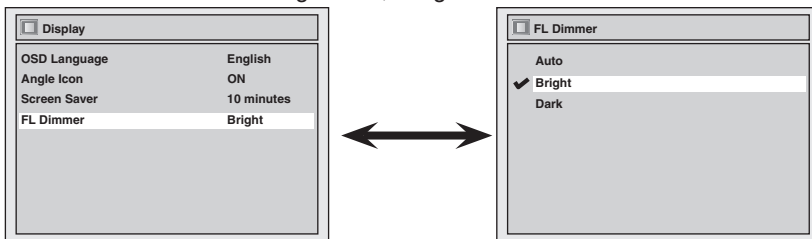

- Using **[▲ / ▼]**, select a setting. Press **[ENTER]**. Your setting will be activated.
- If "Auto" is selected, the display is shown brighter when the power is on, darker when the power is off.

4

Press **[SETUP]** to exit.

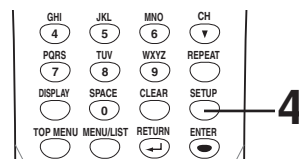

Audio setting

Choose the appropriate Audio settings for your equipment.

It will only affect DVD discs during playback.

Press **[STOP ■]** if you are playing a disc.

1

Press **[SETUP]**.

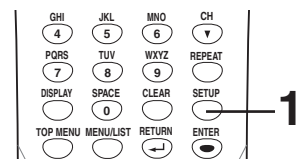

Changing the Setup menu

Audio setting (cont'd)

2

Using [▲ / ▼], select "Playback". Press [ENTER].
Playback menu will appear.

3

Using [▲ / ▼], select "Audio". Press [ENTER].

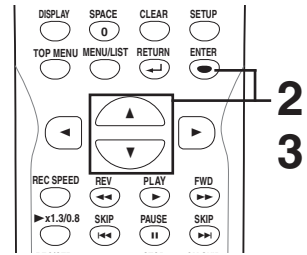

Note

- Dynamic Range Control function is available only on the discs which are recorded in the Dolby Digital format.

Digital Out

Set the digital audio output.

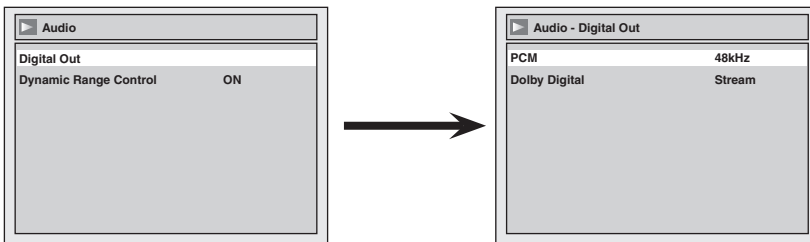

- Using [▲ / ▼], select a setting. Press [ENTER].
Option window will appear.
Proceed to step A or B.

A Settings for PCM (Default : 48kHz)

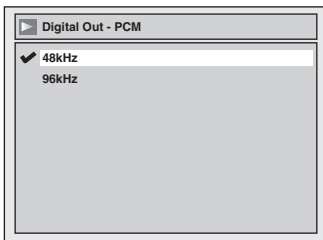

- Using [▲ / ▼], select a setting. Press [ENTER].
Your setting will be activated.
- 48kHz :If your amplifier/decoder is NOT compatible with 96kHz PCM, select "48kHz". 96kHz sound will be output in 48kHz.
- 96kHz :If your amplifier/decoder is compatible with 96kHz PCM, select "96kHz". 96kHz sound will be output.

Note

- When playing disc with copyright protection
- Even if you select "96kHz", the sound will be down sampled at 48kHz.

B Settings for Dolby Digital (Default : Stream)

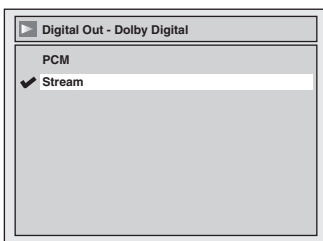

- Using [▲ / ▼], select a setting. Press [ENTER].
Your setting will be activated.
- PCM :Convert the Dolby Digital into PCM(2 channel).
When your amplifier/decoder is NOT compatible with Dolby Digital, set to "PCM".
- Stream :Outputs Dolby Digital signals.
When your amplifier/decoder is compatible with Dolby Digital, set to "Stream".

Note

- When playing a DVD-RW disc recorded in VR mode
- If the audio source on a disc is Dolby Digital format, set "Dolby Digital" to "PCM" so that you can switch to main (L), sub audio (R), or a mix of both (L/R) with your amplifier/decoder.

Instructions continue on the next page.

Changing the Setup menu

Audio setting (cont'd)

Dynamic Range Control (Default : ON)

Set to ON to compress the range between soft and loud sounds.

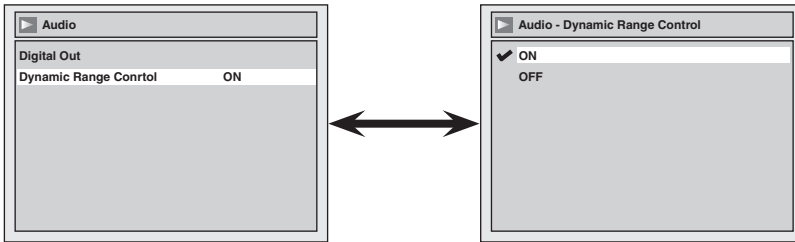

- Using [▲ / ▼], select a setting. Press [ENTER]. Your setting will be activated.

4

Press [SETUP] to exit.

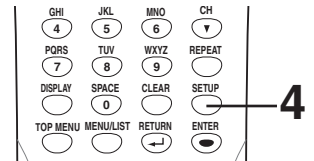

Settings for Parental lock level

Some DVD-Video discs feature a Parental Lock level. Playback will stop if the ratings exceed the levels you set, it will require you to enter a password before the disc will playback. This feature prevents your children from viewing inappropriate material.

Press [STOP ■] if you are playing a disc.

1

Press [SETUP].

2

Using [▲ / ▼], select "Playback". Press [ENTER]. Playback menu will appear.

3

Using [▲ / ▼], select "Parental Lock". Press [ENTER].

4

Using [▲ / ▼], select the desired level. Press [ENTER].

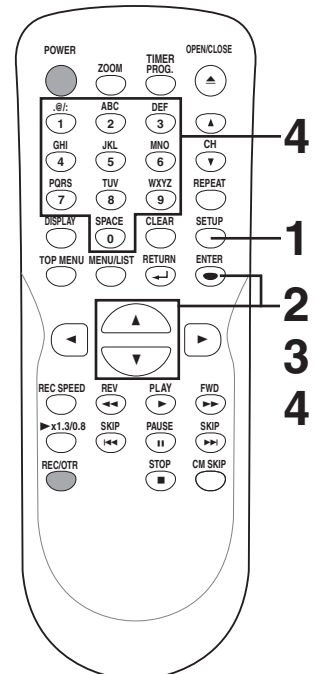

Note

- Parental lock function may not be available to some discs.
- With some DVDs, it may be difficult to find if they are compatible with parental lock. Be sure to check if the parental lock function operates in the way that you have set.
- Record the password in case you forget it.

Changing the Setup menu

Settings for Parental lock level (cont'd)

Parental Lock (Default : All)

Set the Parental Lock level.

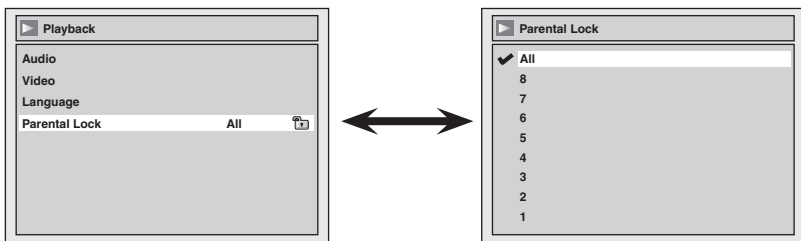

- Using **[▲ / ▼]**, change the parental level. Press **[ENTER]**.
Option window will appear
Proceed to step A or B.

A A password has not been set yet.

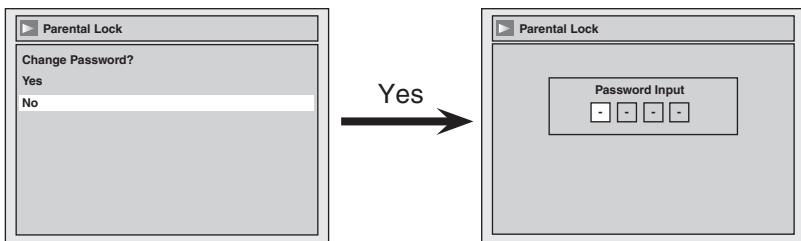

- Using **[▲ / ▼]**, select “Yes”.
Using the Number buttons, enter a new password. Press **[ENTER]**.
Your setting will be activated.

- If you select “No”, proceed to Step 5.

B A password has been set already.

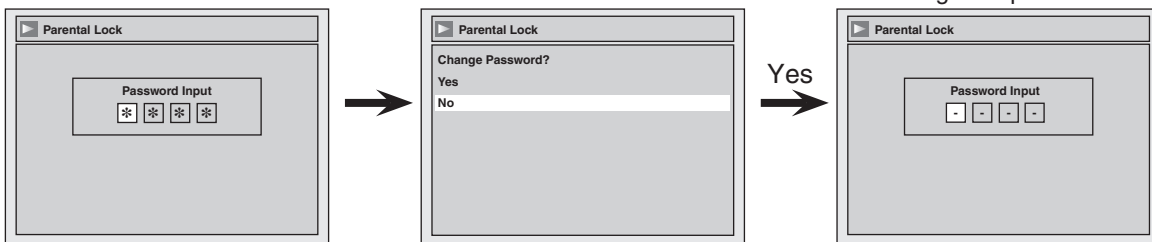

- Using the Number buttons, enter the current password.

- If you select “No”, proceed to Step 5.

- Using **[▲ / ▼]**, select “Yes”.
Using the Number buttons, enter a new password. Press **[ENTER]**.
Your setting will be activated.

5 Press **[SETUP]** to exit.

Note

- Press **[CLEAR]** to erase numbers entered incorrectly.
- When you forget the password or you want to clear all settings in Parental lock, enter **4,7,3,7** using the **Number buttons** in Password Input window. Password will be cleared and parental levels will be set to All.

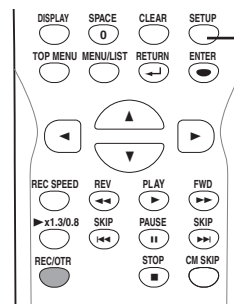

Others

Troubleshooting

Before requesting service for this unit, check the table below for a possible cause of the problem you are experiencing. Some simple checks or a minor adjustment on your part may eliminate the problem and restore proper operation.

Symptom	Remedy
Power	
The power does not turn on.	<ul style="list-style-type: none">• Check that the AC power cord is connected securely.• (In case of power failure) Check the breaker.
Picture	
There is no picture.	<ul style="list-style-type: none">• Re-connect the connecting cords securely.• Check if the connecting cords are damaged.• If Setup Display appears on the TV screen, press [RETURN ←] to turn off the display.• Check the connection to your TV (page 13).• Check if the INTERLACE/PROGRESSIVE mode is set correctly according to your TV (page 13).• Switch the input selector on your TV (such as to "LINE1") so that the signal from the unit appears on the TV screen.
Picture noise appears.	<ul style="list-style-type: none">• The disc is dirty or flawed.• If the picture output signal from the unit passes through your VCR to get to your TV, or if you are connected to a combination TV/VIDEO player, the copy-protection signal applied to some DVD programs could affect picture quality. If you still experience this problem even when you connect the unit directly to your TV, try connecting the unit to your TV's S-VIDEO input.
TV program reception does not fill the screen.	<ul style="list-style-type: none">• Try to set the channels with "Auto Preset" in the Setup menu (page 18).• Select a channel of any TV program using [CH ▲ / ▼].
TV program pictures are distorted.	<ul style="list-style-type: none">• Adjust TV antenna.• Adjust the picture (see the TV's instruction manual).• Place the unit and TV farther apart.• Place the TV and any bunched antenna cables farther apart.
TV channels cannot be changed.	<ul style="list-style-type: none">• Switch the input to TV.• Connect the antenna cable correctly (page 13).
Playback picture is distorted	<ul style="list-style-type: none">• Keep the equipment which may cause electrical disturbances, such as a cellular phone, away.
The playback picture or TV program from the equipment connected through the unit is distorted.	<ul style="list-style-type: none">• If the playback picture output from a DVD player, VCR or tuner goes through the unit before reaching your TV, the copy-protection signal applied to some programs could affect picture quality. Disconnect the playback equipment in question and connect it directly to your TV.
Sound	
There is no sound.	<ul style="list-style-type: none">• The disc is dirty or flawed.• Re-connect all connections securely.• Check if the connecting cord is damaged.• Check the connections to the amplifier input.• The input source setting on the amplifier is incorrect.• The recorder is in pause mode or in Slow-motion Play mode.• The recorder is in fast forward or fast reverse mode.• If the audio signal does not come through the DIGITAL OUT (COAXIAL) jack, check the Audio settings (pages 68-70).
Sound is noisy.	<ul style="list-style-type: none">• The disc is dirty or flawed.
No DTS sound is output.	<ul style="list-style-type: none">• This unit is not compatible with DTS sound.
Remote control	
The remote control does not function.	<ul style="list-style-type: none">• Batteries are weak.• There are obstacles between the remote control and the unit.• The remote control is far from the unit.• There are no batteries in the remote control.• Turn on the unit.• The remote control is not pointed at the remote sensor on the unit.• If above remedies do not solve the problem, please call an Authorized Service Center for help.

Troubleshooting (cont'd)

Symptom	Remedy
Playback	
The disc does not play.	<ul style="list-style-type: none"> • No disc is inserted. • A blank disc is inserted. • The disc is upside down. Insert the disc with the labeled side facing up. • The disc is not correctly inserted. • The unit cannot play certain discs (such as a CD-ROM) (page 37). • The region code on the DVD-Video does not match the unit (page 37). • Moisture has condensed inside the unit. Remove the disc and leave the unit turned on for about two hours until the moisture evaporates (page 4). • If the disc was recorded on another recorder, the unit cannot play the disc if it was not finalized (page 35).
Playback image freezes for a second.	<ul style="list-style-type: none"> • During the playback of two layered disc, picture may freeze for a moment when the 1st layer switches to the 2nd layer. This is not a malfunction.
The disc does not start playback from the beginning.	<ul style="list-style-type: none"> • Resume play was activated (page 41). Press [STOP ■] twice. • You have inserted a disc whose Title menu or DVD menu automatically appears on the TV screen when it is first insert.
The unit starts playing from the disc automatically.	<ul style="list-style-type: none"> • The DVD-Video features an auto playback function.
Some functions such as Stop, Search, or Slow-motion Play cannot be performed.	<ul style="list-style-type: none"> • Depending on the disc, you may not be able to do some of the operations above. See the instruction manual supplied with the disc.
The language for the sound track cannot be changed.	<ul style="list-style-type: none"> • Multilingual tracks are not recorded on the DVD-Video, DVD-R or DVD-RW being played. • The DVD-Video prohibits the changing of the language for the sound track. • Try changing the language using the DVD-Video's menu.
The subtitle language cannot be changed or turned off.	<ul style="list-style-type: none"> • Multilingual subtitle are not recorded on the DVD-Video. • The DVD-Video prohibits changing of the subtitles. • Try changing the subtitle using the DVD-Video's menu.
The angles cannot be changed.	<ul style="list-style-type: none"> • Multi-angles are not recorded on the DVD-Video being played. • The angle-change operation is whenever possible as long as the disc contains a multi-angle portion. Actual change will be performed when the portion has come up. • The DVD-Video prohibits changing angles. • Try changing the angle using the DVD-Video's menu.
Recording/Timer Recording/Editing	
The channel cannot be changed from the channel you are recording.	<ul style="list-style-type: none"> • Set the TV's input to "TV".
Recording does not start immediately after you press [REC/OTR] .	<ul style="list-style-type: none"> • An unused DVD-R or DVD-RW has been inserted. It takes a while for the unit to automatically format a DVD-RW.
Nothing was recorded even though you set the timer setting correctly.	<ul style="list-style-type: none"> • There was a power failure during recording. • The unit's internal clock stopped due to a power failure that lasted for more than 30 seconds. Reset the clock (pages 21- 22). • Disconnect the AC power cord from the AC outlet, and connect it again. • The program contains copy protection signals that restricts copying. • The timer setting overlapped with another setting that was set later or has priority.
Recording does not stop immediately after you press [STOP ■] .	<ul style="list-style-type: none"> • It will take a few seconds for the unit to input disc data before recording can stop.
Timer Recording is not complete or did not start from the beginning.	<ul style="list-style-type: none"> • The timer setting overlapped with another setting that was set previously has priority (page 32). • Disc space was not enough.

Others

Troubleshooting (cont'd)

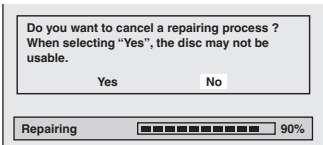
Symptom	Remedy
Others	
The unit does not operate properly.	<ul style="list-style-type: none"> When static electricity, etc., causes the unit to operate abnormally, unplug the unit and then plug it in again.
The disc tray does not open when you press [OPEN/CLOSE ▲].	<ul style="list-style-type: none"> It may take a few seconds for the disc tray to open after you have recorded or edited a disc.
"Repairing" appears on the display.  In a case you intend to cancel the Repairing process. 	<ul style="list-style-type: none"> If there is a power failure or unplugging during recording, finalizing, formatting or editing (even after "Wait for a moment." message is disappeared), a Repairing process will begin automatically just after turning the unit on again. It may take several minutes up to about four hours. If you intend to cancel the Repairing process, press [OPEN/CLOSE ▲] on the front panel, then select "Yes" with [◀/▶] and press [ENTER]. After that, press [OPEN/CLOSE ▲] to take out the disc. The disc canceled the Repairing process MAY NOT work.

Error message	Cause	Solution
<div style="border: 1px solid black; padding: 2px; width: fit-content; margin-bottom: 5px;">Disc Error</div> --- Please eject the disc. --- Playback feature may not be available on this Disc.	<ul style="list-style-type: none"> Unplayable disc is inserted in the unit. The disc is upside down. 	<ul style="list-style-type: none"> Insert the standardized disc which bear the marks on page 37. Insert the disc with the labeled side facing up.
<div style="border: 1px solid black; padding: 2px; width: fit-content; margin-bottom: 5px;">Region Error</div> --- Please eject the disc. --- Playback is not authorized in your region.	<ul style="list-style-type: none"> Playback is not authorized in the region of the DVD-Video disc which you inserted in the unit. 	<ul style="list-style-type: none"> Insert the DVD-Video disc with region codes 1 or ALL.
<div style="border: 1px solid black; padding: 2px; width: fit-content; margin-bottom: 5px;">Parental Lock On</div> The current selected parental level prohibits playback.	<ul style="list-style-type: none"> The current selected parental level in the Setup menu prohibits playback. 	<ul style="list-style-type: none"> Check the "Parental Lock" setting (pages 70-71).
<div style="border: 1px solid black; padding: 2px; width: fit-content; margin-bottom: 5px;">Recording Error</div> This program is not allowed to be recorded.	<ul style="list-style-type: none"> The recording function encountered the copy prohibited program. 	<ul style="list-style-type: none"> You cannot record copy prohibited programs.
<div style="border: 1px solid black; padding: 2px; width: fit-content; margin-bottom: 5px;">Recording Error</div> This program is not recordable in Video mode.	<ul style="list-style-type: none"> You are trying to record the copy-once program onto the DVD-RW disc in Video mode. 	<ul style="list-style-type: none"> Set "Format mode" to "VR mode"(page 26).
<div style="border: 1px solid black; padding: 2px; width: fit-content; margin-bottom: 5px;">Recording Error</div> Can not record on this disc.	<ul style="list-style-type: none"> You are trying to record onto the disc which is unrecordable, or the disc status is unable to record. The disc is dirty. The disc is damaged. 	<ul style="list-style-type: none"> Insert the recordable disc, and ensure the disc status satisfies the recording requirements (pages 24-25). Clean the disc with a cleaning cloth. Replace the disc.
<div style="border: 1px solid black; padding: 2px; width: fit-content; margin-bottom: 5px;">Recording Error</div> This program is not allowed to be recorded on this disc.	<ul style="list-style-type: none"> You are trying to record the copy-once program onto the DVD-RW disc which is not compatible with CPRM. 	<ul style="list-style-type: none"> Insert the DVD-RW disc in VR mode (ver.1.1 or 1.2 compatible with CPRM).
<div style="border: 1px solid black; padding: 2px; width: fit-content; margin-bottom: 5px;">Recording Error</div> This disc is protected and not recordable.	<ul style="list-style-type: none"> You are trying to record on to the protected disc which is set in the Disc menu. 	<ul style="list-style-type: none"> Release the disc protect setting in the Disc menu (page 34).
<div style="border: 1px solid black; padding: 2px; width: fit-content; margin-bottom: 5px;">Recording Error</div> Disc is full. (No area for new recording)	<ul style="list-style-type: none"> You are trying to record onto the disc which has no space for recording. 	<ul style="list-style-type: none"> Insert the recordable disc with enough recording space.

Others

Troubleshooting (cont'd)

Error message	Cause	Solution
Recording Error You cannot record more than 99 titles on one disc. (The maximum is 99)	You are trying to record onto the disc on which the number of recording titles comes up to the maximum (99).	Delete unnecessary titles (pages 51, 54).
Recording Error You cannot record more than 999 chapters on one disc. (The maximum is 999)	You are trying to record onto the VR mode DVD-RW disc on which the number of recording chapters comes up to the maximum (999).	Delete unnecessary chapter markers (page 63).
Recording Error You cannot record on this disc as Control Information is full.	This disc has no space to write the Control Information when recording or deleting contents. When editing has been repeatedly performed, the control Information area may come up to be full even the recording area has enough space.	Delete unnecessary titles (pages 51, 54).
Recording Error You cannot record on this disc as Power Calibration Area is full.	When recordings are performed repeatedly onto an unstable disc, this area may come up to be full. Every time you insert a disc for recording, the disc's working area will be taken up. And if you repeat this frequently, it will be used up sooner and you may not be able to record full 99 titles.	Insert a new disc.
Recording Error This disc is already finalized.	You are trying to record onto the disc already finalized.	Release the finalizing for this disc (page 35).

* If you are still having trouble with the unit after checking "Troubleshooting", write down the error code and the error description for calling our help line mentioned on the front page to locate an Authorized Service Center.

Language code

Language	Code	Language	Code	Language	Code	Language	Code
Abkhazian	4748	French	5264	Lithuanian	5866	Sindhi	6550
Afar	4747	Frisian	5271	Macedonian	5957	Singhalese	6555
Afrikaans	4752	Galician	5358	Malagasy	5953	Siswat	6565
Albanian	6563	Georgian	5747	Malay	5965	Slovak	6557
Amharic	4759	German	5051	Malayalam	5958	Slovenian	6558
Arabic	4764	Greek	5158	Maltese	5966	Somali	6561
Armenian	5471	Greenlandic	5758	Maori	5955	Spanish	5165
Assamese	4765	Guarani	5360	Marathi	5964	Sundanese	6567
Aymara	4771	Gujarati	5367	Moldavian	5961	Swahili	6569
Azerbaijani	4772	Hausa	5447	Mongolian	5960	Swedish	6568
Bashkir	4847	Hebrew	5569	Nauru	6047	Tagalog	6658
Basque	5167	Hindi	5455	Nepali	6051	Tajik	6653
Bengali; Bangla	4860	Hungarian	5467	Norwegian	6061	Tamil	6647
Bhutani	5072	Icelandic	5565	Occitan	6149	Tatar	6666
Bihari	4854	Indonesian	5560	Oriya	6164	Telugu	6651
Bislama	4855	Interlingua	5547	Oromo (Afan)	6159	Thai	6654
Breton	4864	Interlingue	5551	Panjabi	6247	Tibetan	4861
Bulgarian	4853	Inupiak	5557	Pashto; Pushto	6265	Tigrinya	6655
Burmese	5971	Irish	5347	Persian	5247	Tonga	6661
Byelorussian	4851	Italian	5566	Polish	6258	Tsonga	6665
Cambodian	5759	Japanese	5647	Portuguese	6266	Turkish	6664
Catalan	4947	Javanese	5669	Quechua	6367	Turkmen	6657
Chinese	7254	Kannada	5760	Rhaeto-Romance	6459	Twi	6669
Corsican	4961	Kashmiri	5765	Romanian	6461	Ukrainian	6757
Croatian	5464	Kazakh	5757	Russian	6467	Urdu	6764
Czech	4965	Kinyarwanda	6469	Samoan	6559	Uzbek	6772
Danish	5047	Kirgiz	5771	Sangho	6553	Vietnamese	6855
Dutch	6058	Kirundi	6460	Sanskrit	6547	Volapuk	6861
English	5160	Korean	5761	Scots Gaelic	5350	Welsh	4971
Esperanto	5161	Kurdish	5767	Serbian	6564	Wolof	6961
Estonian	5166	Laothian	5861	Serbo-Croatian	6554	Xhosa	7054
Faroese	5261	Latin	5847	Sesotho	6566	Yiddish	5655
Fiji	5256	Latvian; Lettish	5868	Setswana	6660	Yoruba	7161
Finnish	5255	Lingala	5860	Shona	6560	Zulu	7267

Analog audio

An electrical signal that directly represents sound. Compare this to digital audio which can be an electrical signal, but is an indirect representation of sound. See also Digital audio.

Aspect ratio

The width of a TV screen relative to its height. Conventional TVs are 4:3 (in other words, the screen is almost square); widescreen models are 16:9 (the screen is almost twice as wide as it is high).

Chapter

Just as a book is split up into several chapters, a title on a DVD disc is usually divided into chapters. See also Title.

Component video output

Each signal of luminance(Y) and component(Pb/Cb, Pr/Cr) is independent to output so that you can experience picture color as it is. Also, due to compatibility with progressive video (525p/480p), you can experience higher-density picture than that in interlace (525i/480i).

CPRM

(Content Protection for Recordable Media)

CPRM is a copy protection system with scramble system regarding the recording of "copy-once" broadcast programs (e.g. some satellite broadcasts).

Digital audio

An indirect representation of sound by numbers. During recording, the sound is measured at discrete intervals (44,100 times a second for CD audio) by an analog-to-digital converter, generating a stream of numbers. On playback, a digital-to-analog converter generates an analog signal based on these numbers. See also Sampling frequency and Analog audio.

Dolby Digital

The system to compress digital sound developed by Dolby Laboratories. It offers you sound of stereo(2ch) or Multi-channel audio.

Finalize

To make DVD discs, which have been recorded on, possible to play in DVD players. With this unit, it is possible to finalize DVD-R/DVD-RW discs.

MP3 (MPEG Audio Layer 3)

MP3 is a method of compressing files. You can copy MP3 files on CD-RW/R discs from the computer and play the files on this unit.

PCM

(Pulse Code Modulation)

The most common system of encoding digital audio, found on CDs and DAT. Excellent quality, but requires a lot of data compared to formats such as Dolby Digital and MPEG audio. For compatibility with digital audio recorders (CD, MD and DAT) and AV amplifiers with digital inputs, this unit can convert Dolby Digital and MPEG audio to PCM. See also Digital audio.

Playlist

From this list you can play contents of a disc as your desired order or in sequence. Also it is allowed to search a specific scene directly.

Progressive Scan (525p/480p)

A type of display that does not split each frame into fields, and instead scans directly through all the scanlines of each frame in order. Progressive Scan provides less flickering and higher image resolution than traditional (525i/480i) TV signals. Refer to page 13 for instructions on selective Progressive Scan mode.

Regions code

Regions associate discs and players with particular areas of the world. This unit will only play discs that have compatible region codes. You can find the region code of your unit by looking on the rear panel. Some discs are compatible with more than one region (or all regions).

Sampling frequency

The rate which sound is measured by a specified interval to turn into digital audio data. The numbers of sampling in one second defines as sampling frequency. The higher the rate, the better the sound quality as possible as it is.

SAP

(Secondary Audio Program)

Sub audio channel which is delivered separately from main-audio channel. This audio channel is used as an alternate in bilingual broadcasting.

S-Video output

It delivers independently each signal of color(C) and luminance(Y) to TV as video signals, so that higher-quality picture will be gained.

Title (DVD only)

A collection of chapters on DVD disc. See also chapter.

Track

Audio CDs use tracks to divide up the content of a disc. The DVD equivalent is called a chapter. See also Chapter.

Frequently Asked Questions

- Can I record to CD-R/RW?
No, this unit records only DVDs.
- Can I play DVD-Video that is bought in another country?
Possible when the region code of the disc is 1 and All.
- Is this unit JPEG compatible?
No.
- Can I connect the unit to my PC?
No, you cannot control the unit by PCs.

Others

Specifications

General

System	DVD-Video, DVD-RW/R, CD-DA, CD-RW/R
Power requirements	AC120 V, 60 Hz
Power consumption	20 W (standby: 2.8 W)
Weight	5.1 lbs (2.3 kg)
Dimensions (width x height x depth)	17 3/16" x 2 5/8" x 9 5/8" (435 x 66 x 244 mm)
Operating temperature	41F° to 104F° (5°C to 40°C)
Operating humidity	Less than 80% (no condensation)
TV format	NTSC

Recording

Recording format	Video Recording format (DVD-RW only), Video format (DVD-RW, DVD-R)
Recordable discs	DVD-Rewritable, DVD-Recordable
Video recording format	
Sampling frequency	13.5MHz
Compression format	MPEG
Audio recording format	
Sampling frequency	48kHz
Compression format	Dolby Digital

Tuner

Receivable channels	
VHF	2-13ch
UHF	14-69ch
CATV	C1-C125ch

Input / Output

VHF/UHF antenna input/output terminal	VHF/UHF set 75
Video input	Input 1 (rear), 2 (front)
Input level	1 Vp-p (75)
Jacks	RCA jack
Video output	Output 1 (rear)
Output level	1 Vp-p (75)
Jack	RCA jack
S-Video input	Input 1 (rear), 2 (front)
Y (luminance) - Input level	1 Vp-p (75)
C (color) - Input level	286 mVp-p (75)
Jacks	4 pin mini DIN
S-Video output	Output 1 (rear)
Y (luminance) - Output level	1 Vp-p (75)
C (color) - Output level	286 mVp-p (75)
Jack	4 pin mini DIN
Component video output	Output 1 (rear)
Output level	Y: 1.0 Vp-p (75), PB/CB, PR/CR: 0.7 Vp-p (75)
Jacks	RCA jacks
Audio input	Input 1 (rear), 2 (front) L/R
During audio input	2V rms (Input impedance: more than 22k)
Jacks	RCA jacks
Audio output	Output 1 L/R (rear)
During audio output	2V rms (Output impedance: less than 1k)
Jacks	RCA jacks
Digital audio output	Output 1 (rear) COAXIAL
Output level	500 mVp-p (75)
Jacks	RCA jack

Note:

The specifications and design of this product are subject to change without notice.

Fácil grabación de DVD

Estas instrucciones le ayudarán a entender fácilmente cómo grabar discos DVD.

Nota:

Asegúrese que las pilas están en el mando a distancia y que ha conectado correctamente esta unidad y el TV.

Paso 1: Elija un tipo de disco.

Puede elegir entre distintos tipos de discos DVD grabables. Elija un tipo de disco DVD grabable de acuerdo con sus necesidades de reproducción/grabación. Vea los "Tipos de discos DVD" en la parte inferior de esta página para más detalles sobre las diferencias entre los distintos medios compatibles.

Este grabador de DVD puede grabar los siguientes tipos de discos.



Por ejemplo, cuando desea grabar repetidamente en el mismo disco o cuando desea editar el disco después de grabar, seleccione el disco de tipo regrabable DVD-RW. Cuando desea guardar grabaciones sin alterarlos, un DVD no regrabable DVD-R puede ser más conveniente.

Paso 2: Coloque un disco en blanco.

Mando a distancia

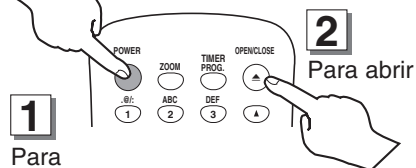

1 Para encender

2 Para abrir

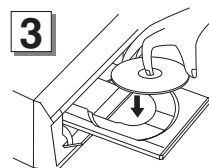

3

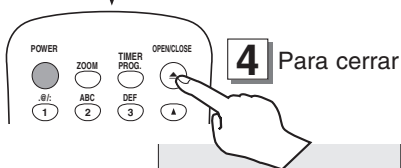

4 Para cerrar



Esta operación puede demorar en reconocerse.

Tipos de discos DVD

☆☆☆ : Más adecuado ☆☆☆ : Puede utilizar ☆ : Algunas funciones son limitadas — : No puede utilizar

Desea	DVD-RW VR	DVD-RW Video	DVD-R
Grabar programas de TV	☆☆☆	☆☆☆	☆☆
Volver a utilizar borrando partes no deseadas	☆☆☆	☆☆	—
Editar las grabaciones	☆☆☆	☆	☆
Editar/grabar de equipos conectados	☆☆☆	☆☆☆	☆☆☆
Copiar discos para distribución	☆☆ ^{*1}	☆☆☆	☆☆☆
Reproducir en otro equipo de DVD	☆☆ ^{*1}	☆☆☆	☆☆☆

Detalles	DVD-RW VR	DVD-RW Video	DVD-R
Grabación			
¿Regrabable?	Sí	Sí	No
Puede crear capítulos a intervalos fijos (auto.)	Sí	Sí	Sí
Puede crear capítulos donde desee (manual)	Sí	No	No
Puede grabar imágenes de tamaño 16:9	Sí	Sí	Sí
Puede grabar un programa de Copia-una-vez	Sí	No	No
Edición			
Puede hacer funciones de edición básica	Sí	Sí	Sí
Puede hacer funciones de edición avanzadas (edición de lista a reproducir)	Sí	No	No

*1 El DVD-RW (modo VR) sólo puede reproducirse en equipos de DVD compatibles con VR.

Nota: Para más detalles sobre las funciones anteriores y las limitaciones implícitas, lea las explicaciones en este manual.

Formato del disco

Coloque el disco en el grabador. Haga el formato del disco del menú SETUP, existen los formatos de video (modo de Video) o de grabación de video (modo VR) según el tipo de disco colocado.

Esto es necesario para preparar el disco para grabación. Vea los detalles en las páginas 26-27.

* Al formatear, todo el contenido de ese disco se borrará.

* La unidad empieza a formatear automáticamente cuando se inserta un disco DVD-RW no usado.

Paso 3: Seleccione la velocidad de grabación.

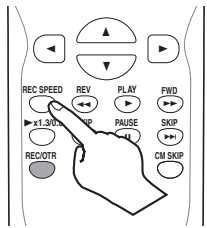

Paso 4: Seleccione el canal deseado.

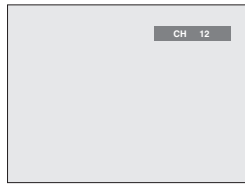
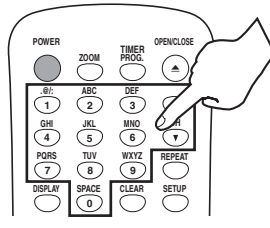

Paso 5: Grabe en discos DVD.

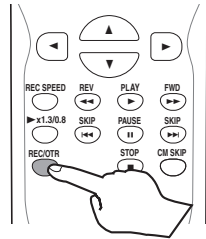

Sugerencia 1: Reproduzca el contenido grabado

Puede seleccionar el título que desea reproducir de un menú indicado y empiece a reproducir inmediatamente. El contenido grabado se puede acceder fácilmente con un simple procedimiento de elegir un título en un capítulo en la pantalla del menú.

¿Qué son títulos y capítulos?

El contenido de un disco DVD se divide generalmente en títulos. Los títulos pueden dividirse a su vez en capítulos.

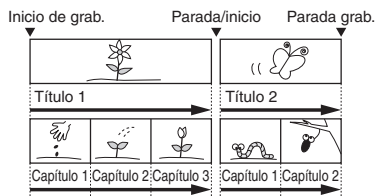

Sugerencia 2: Edite el disco grabado

La edición de discos es fácil. Esta unidad ofrece convenientes funciones de edición que sólo son posibles con discos DVD-RW/R.

Puede editar lo siguiente de la lista de títulos.

- Poniendo nombres en títulos
- Seleccionando imágenes para índices
- Seleccionando/borrando marcadores de capítulos
- Borrado de títulos o escenas

(Las funciones editables dependen del modo de grabación y forma de edición.)

Original y Playlist (modo VR)

Puede editar las grabaciones en la lista a reproducir sin cambiar las grabaciones originales. Cualquier lista a reproducir no ocupa mucho espacio en el disco.

¿Qué significa "Original" o "Playlist"?

A lo largo de este manual encontrará Original y Playlist que se refieren a las grabaciones reales y la versión editada.

- La grabación **Original** se refiere a la grabación real en el disco.
- El **Playlist** se refiere a la versión editada del disco; cómo se va a reproducir la versión Original.

Finalización de un disco

- Esto permitirá que un disco que se grabe en nuestra unidad pueda ser reproducido en un reproductor DVD diferente. Un disco sin finalizar no se podrá reproducir en otro reproductor.
- Después de finalizar un disco, si la grabación se hizo en el modo de vídeo, usted no podrá editar ninguna información que se encuentre en ese disco.
- Si ha grabado en el modo VR en un disco DVD-RW, la edición podrá realizarse incluso después de la finalización.

Paso 6: Pare la grabación.

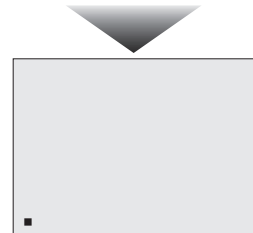
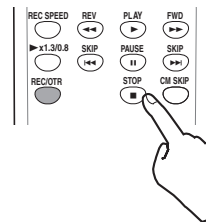

Esta operación puede demorar en completarse.

SYLVANIA

LIMITED WARRANTY

FUNAI CORP. will repair this product, free of charge in the USA in the event of defect in materials or workmanship as follows:

DURATION:

PARTS: FUNAI CORP. will provide parts to replace defective parts without charge for one (1) year from the date of original retail purchase. Certain parts are excluded from this warranty.

LABOR: FUNAI CORP. will provide the labor without charge for a period of ninety (90) days from the date of original retail purchase.

LIMITS AND EXCLUSIONS:

This warranty is extended only to the original retail purchaser. A purchase receipt or other proof of original retail purchase will be required together with the product to obtain service under this warranty.

This warranty shall not be extended to any other person or transferee.

This warranty is void and of no effect if any serial numbers on the product are altered, replaced, defaced, missing or if service was attempted by an unauthorized service center. This limited warranty does not apply to any product not purchased and used in the United States.

This product is produced for home use and this warranty only covers failures due to defects in material or workmanship which occurs during normal use. It does not cover damage which occurs in shipment, or failures which are caused by repairs, alterations or product not supplied by FUNAI CORP, or damage which results from accident, misuse, abuse, mishandling, misapplication, alteration, faulty installation, improper maintenance, commercial use such as hotel, rental or office use of this product or damage which results from fire, flood, lightning or other acts of God.

THIS WARRANTY DOES NOT COVER PACKING MATERIALS, ANY ACCESSORIES (EXCEPT REMOTE CONTROL), ANY COSMETIC PARTS, COMPLETE ASSEMBLY PARTS, DEMO OR FLOOR MODELS.

FUNAI CORP. AND ITS REPRESENTATIVES OR AGENTS SHALL IN NO EVENT BE LIABLE FOR ANY GENERAL, INDIRECT OR CONSEQUENTIAL DAMAGES ARISING OUT OF OR OCCASIONED BY THE USE OF OR THE INABILITY TO USE THIS PRODUCT. THIS WARRANTY IS MADE IN LIEU OF ALL OTHER WARRANTIES, EX OR IMPLIED, AND OF ALL OTHER LIABILITIES ON THE PART OF FUNAI, ALL OTHER WARRANTIES INCLUDING THE WARRANTY OF MERCHANTABILITY AND FITNESS FOR A PARTICULAR PURPOSE, ARE HEREBY DISCLAIMED BY FUNAI AND ITS REPRESENTATIVES IN THE UNITED STATES. ALL WARRANTY INSPECTIONS AND REPAIRS MUST BE PERFORMED BY AN AUTHORIZED SERVICE CENTER. THIS WARRANTY IS ONLY VALID WHEN THE UNIT IS CARRIED-IN TO AN AUTHORIZED SERVICE CENTER.

IMPORTANT:

THIS LIMITED WARRANTY GIVES YOU SPECIFIC LEGAL RIGHTS. YOU MAY HAVE OTHER RIGHTS THAT VARY FROM STATE TO STATE. IF, AT ANY TIME DURING THE WARRANTY PERIOD, YOU ARE UNABLE TO OBTAIN SATISFACTION WITH THE REPAIR OF THIS PRODUCT, PLEASE CONTACT FUNAI CORP.

ATTENTION:

FUNAI CORP. RESERVES THE RIGHT TO MODIFY ANY DESIGN OF THIS PRODUCT WITHOUT PRIOR NOTICE.

To locate your nearest AUTHORIZED SERVICE CENTER or for general service inquiries, please contact us at:

FUNAI CORPORATION
Customer Service

Tel :1-800-605-8453

<http://www.SylvaniaConsumerElectronics.com>

19900 Van Ness Avenue, Torrance, CA 90501

Quick Guide

DVD Recorder DVR90DG

Playable discs

This unit is compatible to play the following discs.

Disc	Logo	Disc	Logo
DVD-VIDEO		CD-DA (AUDIO CD)	
DVD-RW (VIDEO/VR mode)		CD-RW (CD-DA FORMAT, MP3 files)	
DVD-R (VIDEO mode)		CD-R (CD-DA FORMAT, MP3 files)	

is a trademark of DVD Format/Logo Licensing Corporation.

● DVD+R/+RW discs can be played back only on this unit.

Region codes



The number inside the globe refers to region of the world.
This unit can play DVDs that are labeled for ALL regions or for Region 1.

Recordable discs

This unit can record to DVD-R and DVD-RW discs.

DVD-R discs can only be recorded to once, and cannot be erased. DVD-RW discs can be recorded to and erased many times.

DVD-R discs can only be recorded in Video mode, while DVD-RW discs can select a recording format between Video mode and VR mode.

Disc type	Disc format	Functions	Attributes
 DVD-RW: 1-4x	Video mode 	Playing, limited recording, limited editing	8cm/12cm, single-sided, single layer disc Approx. max. recording time (SEP mode): 600 minutes (4.7GB) (for 12cm) 180 minutes (1.4GB) (for 8cm)
	VR mode 	Playing, recording, Original/Playlist editing	
 DVD-R: 2x.4x.8x	Video mode 	Playing, limited recording, limited editing	8cm/12cm, single-sided, single layer disc Approx. max. recording time (SEP mode): 600 minutes (4.7GB) (for 12cm) 180 minutes (1.4GB) (for 8cm)

1

Connections

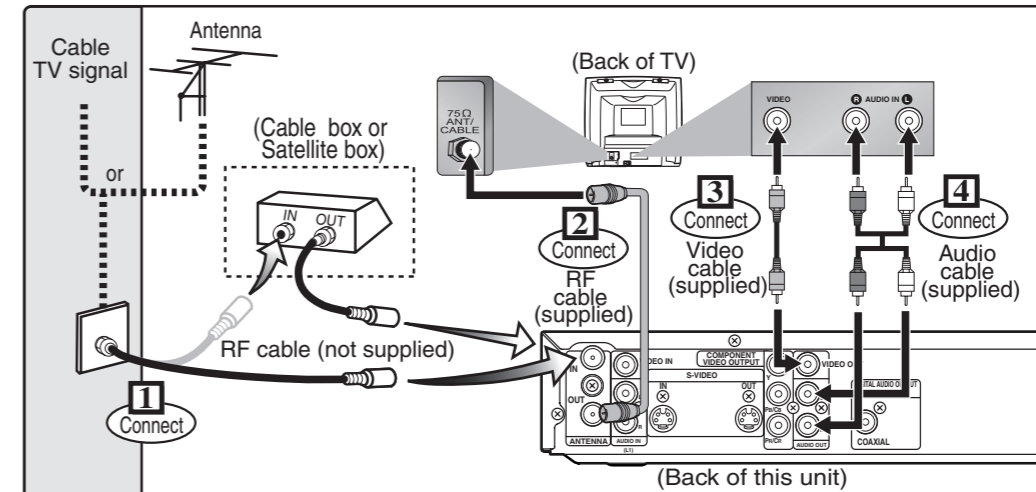

- Both A/V and RF cables must be connected to the TV for operation.
- See front page of the Owner's Manual for the connection with the RF modulator.

2

Watching TV/DVD

2-1 DVD Playback

Press **[POWER]** to turn the unit on.

Press **[OPEN/CLOSE]** to open the disc tray.

Insert a disc.

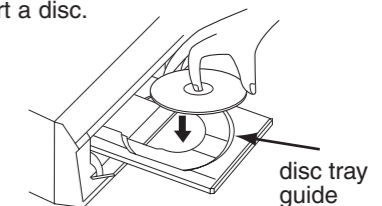
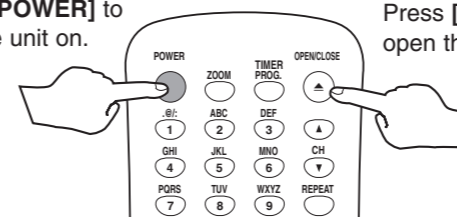

After you have completed connections;

Press the input selector button (usually TV/VIDEO, INPUT or AUX) on your TV to switch an appropriate external input channel (usually near channel 0) for viewing the picture from this unit. Please refer to "Input Mode Names for Common TV Brands" on page 15 of the Owner's manual or the manual accompanying your TV.

2-2 Initial Setting

1. Turn on the TV and the unit in the first time. "Initial Setting" will appear. Using **[▲/▼]**, select your desired language for OSD. Then press **[ENTER]** to go to next step.

2. Press **[ENTER]** to Channel Preset. The unit will start getting channels available in your area.

3. Clock Setting menu will appear. Press **[ENTER]**, default date will appear.

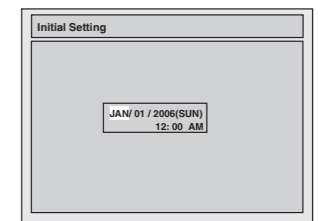
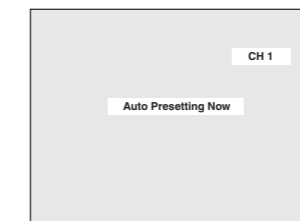
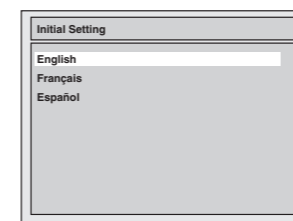

4. Using **[▲/▼]**, enter the date (month / day / year). Press **[◀/▶]** to move the cursor.

5. Using **[▲/▼]**, enter the time (hour / minute). Press **[◀/▶]**. A cursor will move on AM or PM.

6. Press **[▲/▼]** to select "AM" or "PM". Press **[ENTER]**.

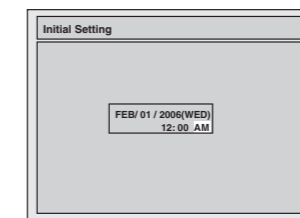
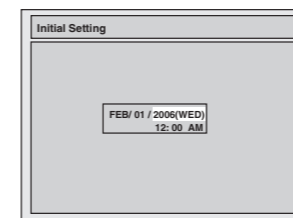

TV Program will automatically appear. (Usually near channel 0)

Playing, recording, and editing discs are available on this unit.

3-1 Easy Recording

Select the recording speed.

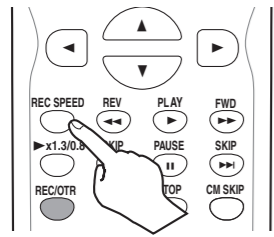

How to select the recording speed:

Disc Size	Recording speed	Recording time	Video/Sound Quality
8cm Disc	XP (1H)	18 min	☆☆☆☆☆ (good)
	SP (2H)	36 min	☆☆☆☆☆
	LP (4H)	72 min	☆☆☆☆
	EP (6H)	108 min	☆☆☆
	SLP (8H)	144 min	☆☆
12cm Disc	SEP (10H)	180 min	☆ (poor)
	XP (1H)	60 min	☆☆☆☆☆ (good)
	SP (2H)	120 min	☆☆☆☆☆
	LP (4H)	240 min	☆☆☆☆
	EP (6H)	360 min	☆☆☆
	SLP (8H)	480 min	☆☆
	SEP (10H)	600 min	☆ (poor)

Select the desired channel.

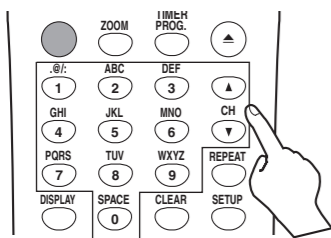

Record on DVD disc.

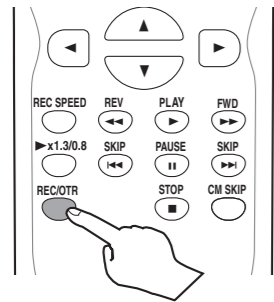

Stop the recording.

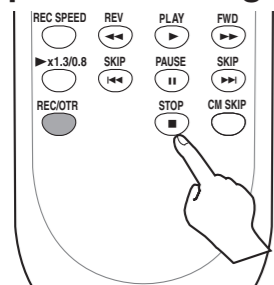

Press repeatedly to select desired recording time

Recording times appear on the TV screen (30 minutes to 8 hours).
Recording will start.

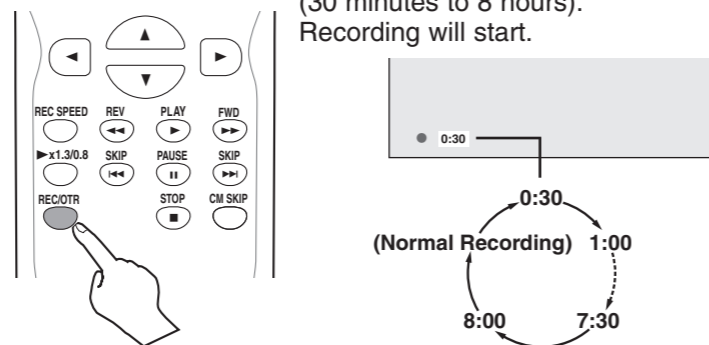

When the unit reaches the specified time, recording will stop automatically.

After all recordings, finalize your disc.

After recording, you must finalize the disc in order to play on other units.

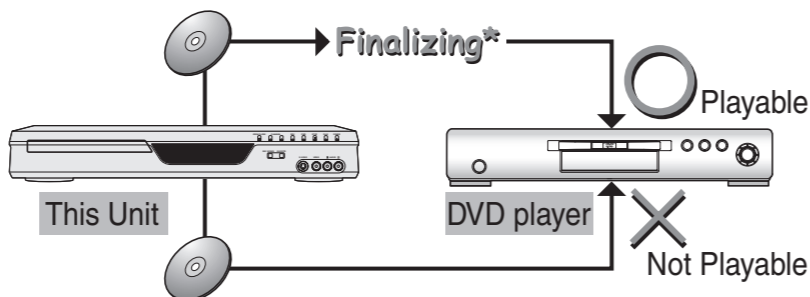

* You cannot finalize discs in other DVD recorders.

3-2 Timer Recording

- You can set up to 8 programs (once, daily or weekly).
- Be sure to set the clock before starting a timer programming.

Press [TIMER PROG.].

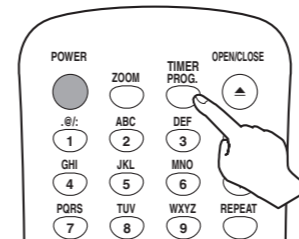

Timer Programming list appears.

Select any blank line with [▲ / ▼] and press [ENTER].

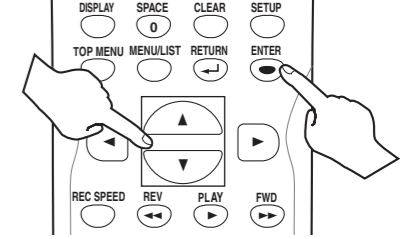
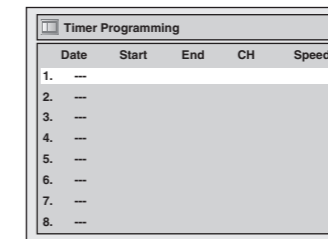

Set the date.

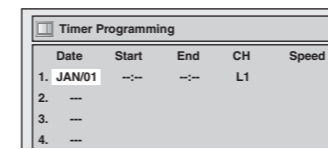

Move to next

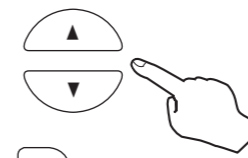

Set start and end time.

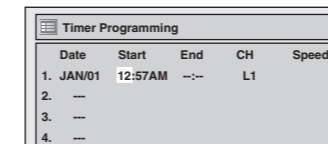

Move to next

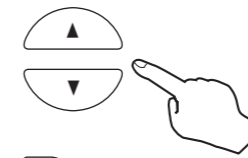

Select the channel number to record.

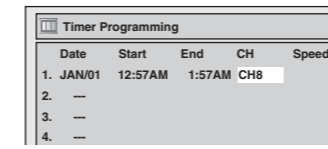

Move to next

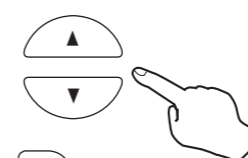

Select the recording speed.

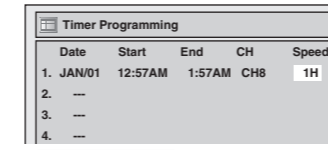

ENTER

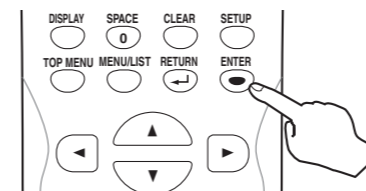

Timer Recording is now set.

When pressing [▼] at the current date, Timer Recording mode will change as follows: e.g. January 1st at present

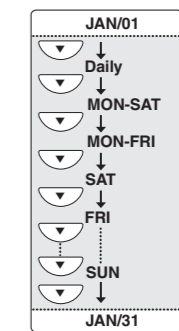

Set the Timer Standby mode
Turn the unit off.

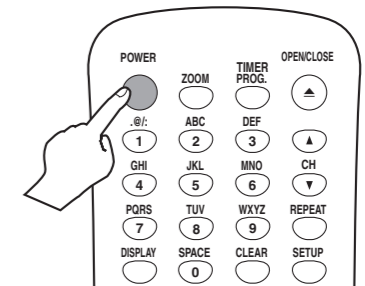

Indicator will appear on the front panel display.



Hints for DVD Recording

- Formatting is not needed when inserting a blank disc. **UNIT AUTOMATICALLY PREPARES THE DISC FOR RECORDING.**
- For playback on other DVD players, be sure to record on Video mode and to finalize the disc once recording is finished. **OTHER PLAYER MUST PLAY BACK DVD-R or DVD-RW.**

Free Manuals Download Website

<http://myh66.com>

<http://usermanuals.us>

<http://www.somanuals.com>

<http://www.4manuals.cc>

<http://www.manual-lib.com>

<http://www.404manual.com>

<http://www.luxmanual.com>

<http://aubethermostatmanual.com>

Golf course search by state

<http://golfingnear.com>

Email search by domain

<http://emailbydomain.com>

Auto manuals search

<http://auto.somanuals.com>

TV manuals search

<http://tv.somanuals.com>