

# OWNER'S MANUAL

# SYLVANIA

## 19-INCH COLOR TV/DVD SRTD219

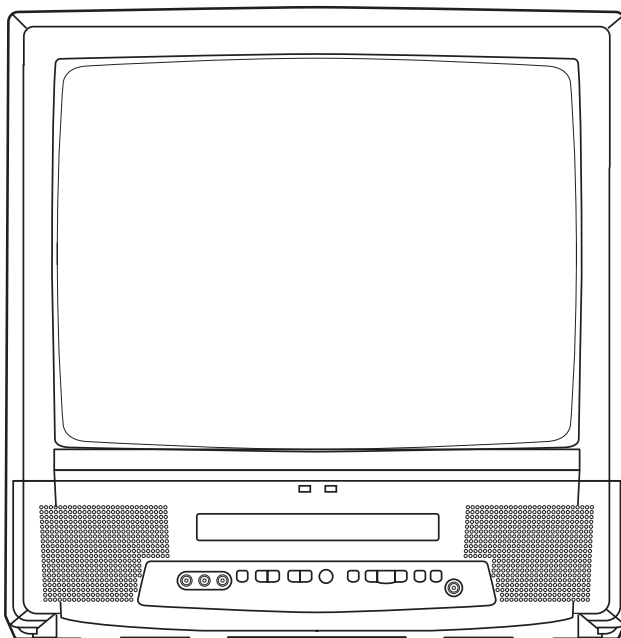

**TruSurround™**  
by **SRS (S)**

**INSTRUCCIONES EN ESPAÑOL INCLUIDAS.**

### SUPPLIED ACCESSORIES

ACCESSORIES	PART NO.
Remote Control Unit	NE205UD
Batteries	2 AA Batteries

If you need additional assistance for set-up or operating  
after reading owner's manual, please call  
**TOLL FREE : 1-800-968-3429**

**Please read before using this equipment.**

Download from [www.Somanuals.com](http://www.Somanuals.com). All Manuals Search And Download.

**WARNING:** TO REDUCE THE RISK OF FIRE OR ELECTRIC SHOCK, DO NOT EXPOSE THIS APPLIANCE TO RAIN OR MOISTURE.



**CAUTION**  
**RISK OF ELECTRIC SHOCK**  
**DO NOT OPEN**



**CAUTION:** TO REDUCE THE RISK OF ELECTRIC SHOCK, DO NOT REMOVE COVER (OR BACK). NO USER SERVICEABLE PARTS INSIDE. REFER SERVICING TO QUALIFIED SERVICE PERSONNEL.



THIS SYMBOL INDICATES THAT DANGEROUS VOLTAGE CONSTITUTING A RISK OF ELECTRIC SHOCK IS PRESENT WITHIN THIS UNIT.



THIS SYMBOL INDICATES THAT THERE ARE IMPORTANT OPERATING AND MAINTENANCE INSTRUCTIONS IN THE LITERATURE ACCOMPANYING THE APPLIANCE.

The caution marking is located on the rear of the cabinet.

## IMPORTANT SAFEGUARDS

**1. Read instructions**-All the safety and operating instructions should be read before the appliance is operated.

**2. Retain Instructions**-The safety and operating instructions should be retained for future reference.

**3. Heed Warnings**-All warnings on the appliance and in the operating instructions should be adhered to.

**4. Follow Instructions**-All operating and use instructions should be followed.

**5. Cleaning**-Unplug TV/DVD from the wall outlet before cleaning. Do not use liquid cleaners or aerosol cleaners. Use a damp cloth for cleaning.

**EXCEPTION:** A product that is meant for uninterrupted service and, that for some specific reason, such as the possibility of the loss of an authorization code for a CATV converter, is not intended to be unplugged by the user for cleaning or any other purpose, may exclude the reference to unplugging the appliance in the cleaning description otherwise required in item 5.

**6. Attachments**-Do not use attachments not recommended by the TV/DVD manufacturer as they may cause hazards.

**7. Water and Moisture**-Do not use this TV/DVD near water-for example, near a bath tub, wash bowl, kitchen sink, or laundry tub, in a wet basement, or near a swimming pool, and the like.

**8. Accessories**-Do not place this TV/DVD on an unstable cart, stand, tripod, bracket, or table. The TV/DVD may fall, causing serious injury to someone, and serious damage to the appliance. Use only with a cart, stand, tripod, bracket, or table recommended by the manufacturer, or sold with the TV/DVD. Any mounting of the appliance should follow the manufacturer's instructions and should use a mounting accessory recommended by the manufacturer. An appliance and cart combination should be moved with care.

Quick stops, excessive force, and uneven surfaces may cause the appliance and cart combination to overturn.

PORTABLE CART WARNING  
AVERTISSEMENT POUR UNE  
TABLE ROULANTE PORTATIVE



S3126A

**Accessoires**- Ne placez pas cette TV/DVD sur une table roulante, un support, un trépied, une console ou une table instable. Cette TV/DVD risquerait de tomber, pouvant gravement blesser quelqu'un et l'appareil même pourrait être sérieusement endommagé. N'utilisez qu'une table recommandée par le fabricant, ou vendu avec la TV/DVD. Pour n'importe quelle installation de l'appareil, on devra suivre les instructions du fabricant et l'on devra utiliser les accessoires d'installation recommandés par le fabricant. L'ensemble combiné de l'appareil avec une table roulante devra être déplacé avec précaution. Des arrêts brusques, une force excessive et des surfaces inégales peuvent provoquer le renversement de l'ensemble combiné de l'appareil/table roulante.

**9. Ventilation**-Slots and openings in the cabinet and the back or bottom are provided for ventilation and to ensure reliable operation of the TV/DVD and to protect it from overheating, and these openings must not be blocked or covered. The openings should never be blocked by placing the TV/DVD on a bed, sofa, rug, or other similar surface. This TV/DVD should never be placed near or over a radiator or heat register. This TV/DVD should not be placed in a built-in installation such as a bookcase or rack unless proper ventilation is provided or the manufacturer's instructions have been adhered to.

**10. Power Sources**-This TV/DVD should be operated only from the type of power source indicated on the marking label. If you are not sure of the type of power supply to your home, consult your appliance dealer or local power company. For TV/DVDs intended to operate from battery power, or other sources, refer to the operating instructions.

**11. Grounding or Polarization**-This TV/DVD is equipped with a polarized alternating-current line plug (a plug having one blade wider than the other). This plug will fit into the power outlet only one way. This is a safety feature. If you are unable to insert the plug fully into the outlet, try reversing the plug. If the plug should still fail to fit, contact your electrician to replace your obsolete outlet. Do not defeat the safety purpose of the polarized plug.

**FIGURE A**  
**EXAMPLE OF ANTENNA GROUNDING AS PER**  
**NATIONAL ELECTRICAL CODE**

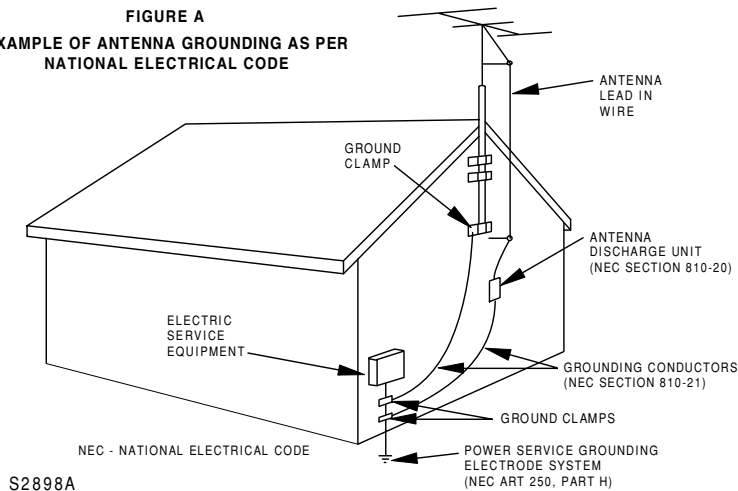

**12. Power-Cord Protection**-Power-supply cords should be routed so that they are not likely to be walked on or pinched by items placed upon or against them, paying particular attention to cords at plugs, convenience receptacles, and the point where they exit from the appliance.

**13. Outdoor Antenna grounding**-If an outside antenna or cable system is connected to the TV/DVD, be sure the antenna or cable system is grounded so as to provide some protection against voltage surges and built-up static charges. Article 810 of the National Electrical Code, ANSI/NFPA No. 70, provides information with respect to proper grounding of the mast and supporting structure, grounding of the lead-in wire to an antenna discharge unit, size of grounding conductors, location of antenna-discharge unit, connection to grounding electrodes, and requirements for the grounding electrode. (Fig. A)

**14. Lightning**-For added protection for this TV/DVD receiver during a lightning storm, or when it is left unattended and unused for long periods of time, unplug it from the wall outlet and disconnect the antenna or cable system. This will prevent damage to the TV/DVD due to lightning and power-line surges.

**15. Power Lines**-An outside antenna system should not be located in the vicinity of overhead power lines or other electric light or power circuits, or where it can fall into such power lines or circuits. When installing an outside antenna system, extreme care should be taken to keep from touching such power lines or circuits as contact with them might be fatal.

**16. Overloading**-Do not overload wall outlets and extension cords as this can result in a risk of fire or electric shock.

**17. Object and Liquid Entry**-Never push objects of any kind into this TV/DVD through openings as they may touch dangerous voltage points or short out parts that could result in a fire or electric shock. Never spill liquid of any kind on the TV/DVD.

**18. Servicing**-Do not attempt to service this TV/DVD yourself as opening or removing covers may expose you to dangerous voltage or other hazards. Refer all servicing to qualified service personnel.

**19. Damage Requiring Service**-Unplug this TV/DVD from the wall outlet and refer servicing to qualified service personnel under the following conditions:

- When the power-supply cord or plug is damaged or frayed.
- If liquid has been spilled, or objects have fallen into the TV/DVD.
- If the TV/DVD has been exposed to rain or water.
- If the TV/DVD does not operate normally by following the operating instructions. Adjust only those controls that are covered by the operating instructions, as improper adjustment of other controls may result in damage and will often require extensive work by a qualified technician to restore the TV/DVD to its normal operation.
- If the TV/DVD has been dropped or damaged in any way.
- When the TV/DVD exhibits a distinct change in performance-this indicates a need for service.

**20. Replacement Parts**-When replacement parts are required, be sure the service technician has used replacement parts specified by the manufacturer that have the same characteristics as the original part. Unauthorized substitutions may result in fire, electric shock, injury to persons or other hazards.

**21. Safety Check**-Upon completion of any service or repairs to this TV/DVD, ask the service technician to perform routine safety checks to determine that the TV/DVD is in proper operating condition.

**22. Heat**-This TV/DVD product should be situated away from heat sources such as radiators, heat registers, stoves, or other products (including amplifiers) that produce heat.

# PRECAUTIONS

## IMPORTANT COPYRIGHT INFORMATION

Unauthorized copying, broadcasting, public performance and lending of discs are prohibited.

**FCC WARNING-** This equipment may generate or use radio frequency energy. Changes or modifications to this equipment may cause harmful interference unless the modifications are expressly approved in the instruction manual. The user could lose the authority to operate this equipment if an unauthorized change or modification is made.

## RADIO-TV INTERFERENCE

This equipment has been tested and found to comply with the limits for a Class B digital device, pursuant to Part 15 of the FCC Rules. These limits are designed to provide reasonable protection against harmful interference in a residential installation.

This equipment generates, uses, and can radiate radio frequency energy and, if not installed and used in accordance with the instructions, may cause harmful interference to radio communications.

However, there is no guarantee that interference will not occur in a particular installation. If this equipment does cause harmful interference to radio or television reception, which can be determined by turning the equipment off and on, the user is encouraged to try to correct the interference by one or more of the following measures:

- 1) Reorient or relocate the receiving antenna.
- 2) Increase the separation between the equipment and receiver.
- 3) Connect the equipment into an outlet on a circuit different from that to which the receiver is connected.
- 4) Consult the dealer or an experienced radio/TV technician for help.

## LASER SAFETY

This unit employs a laser. Only a qualified service person should remove the cover or attempt to service this device, due to possible eye injury.

**CAUTION:** USE OF CONTROLS OR ADJUSTMENTS OR PERFORMANCE OF PROCEDURES OTHER THAN THOSE SPECIFIED HEREIN MAY RESULT IN HAZARDOUS RADIATION EXPOSURE.

**CAUTION:** VISIBLE AND INVISIBLE LASER RADIATION WHEN OPEN AND INTERLOCK DEFEATED. DO NOT STARE INTO BEAM.

**LOCATION:** INSIDE, NEAR THE DECK MECHANISM.

**This Class B digital apparatus complies with Canadian ICES-003.**

**Cet appareil numérique de la classe B est conforme à la norme NMB-003 du Canada.**

**CAUTION:** TO PREVENT ELECTRIC SHOCK, MATCH WIDE BLADE OF PLUG TO WIDE SLOT, FULLY INSERT.

**ATTENTION:** POUR ÉVITER LES CHOC ÉLECTRIQUES, INTRODUIRE LA LAME LA PLUS LARGE DE LA FICHE DANS LA BORNE CORRESPONDANTE DE LA PRISE ET POUSSER JUSQU'AU FOND.

## LOCATION

For safe operation and satisfactory performance of your TV/DVD, keep the following in mind when selecting a place for its installation:

- Shield it from direct sunlight and keep it away from sources of intense heat.
- Avoid dusty or humid places.
- Avoid places with insufficient ventilation for proper heat dissipation. Do not block the ventilation holes at the top and bottom of the unit. Do not place the unit on a carpet because this will block the ventilation holes.
- Install unit in a horizontal position.
- Avoid locations subject to strong vibration.
- Do not place the TV/DVD near strong magnetic fields.
- Avoid moving TV/DVD to locations where temperature differences are extreme.

## WARNING

Moisture condensation may occur inside the unit when it is moved from a cold place to a warm place, or after heating a cold room or under conditions of high humidity. If a DVD is played in a TV/DVD which has moisture, it may damage the DVD and TV/DVD. Therefore when the condensation occurs inside the unit, turn the POWER button on and allow at least 2 hours for the unit to dry out.

## AVOID THE HAZARDS OF ELECTRICAL SHOCK AND FIRE

- Do not handle the power cord with wet hands.
- Do not pull on the power cord when disconnecting it from an AC wall outlet. Grasp it by the plug.
- If, by accident, water is spilled on your unit, unplug the power cord immediately and take the unit to our Authorized Service Center for servicing.
- Do not put your fingers or objects into the TV/DVD disc loading tray.
- Do not place anything directly on top of the unit.

### A NOTE ABOUT RECYCLING

This product's packaging materials are recyclable and can be reused. Please dispose of any materials in accordance with your local recycling regulations.

Batteries should never be thrown away or incinerated but disposed of in accordance with your local regulations concerning chemical wastes.

The serial number of this product may be found on the back of the unit. No other TV/DVD has the same serial number as yours. You should record the number and other vital information here and retain this book as a permanent record of your purchase to aid identification in case of theft. Serial numbers are not kept on file.

Date of Purchase	
Dealer Purchase from	
Dealer Address	
Dealer Phone No.	
Model No.	
Serial No.	

# TABLE OF CONTENTS

■ <b>IMPORTANT SAFEGUARDS</b> .....	2	PAUSING PLAYBACK OR DISPLAYING A STILL PICTURE .....	22
■ <b>PRECAUTIONS</b> .....	4	RESUMING PLAYBACK FROM THE POINT WHERE PLAYBACK STOPPED ...	22
LOCATION .....	5	STEPPING THROUGH FRAMES .....	22
AVOID THE HAZARDS OF ELECTRICAL SHOCK AND FIRE .....	5	FAST FORWARD/REVERSE .....	23
WARNING .....	5	SLOW MOTION .....	23
■ <b>FEATURES</b> .....	7	STARTING FROM A DESIRED TRACK ...	23
■ <b>SUPPLIED ACCESSORIES</b> .....	7	STARTING FROM A DESIRED TIME COUNT	23
■ <b>OPERATING CONTROLS AND FUNCTIONS</b>	8	PLAYING FROM A DESIRED TITLE OR CHAPTER .....	24
■ <b>PREPARATION FOR USE</b> .....	10	RANDOM (Audio CD) .....	24
ANTENNA/CABLE CONNECTIONS .....	10	REPEAT .....	24
INSTALLING THE BATTERIES .....	12	A-B REPEAT .....	25
CONNECTING TO EXTERNAL INPUT JACKS	12	PROGRAM (Audio CD) .....	25
CONNECTING TO A STEREO SYSTEM (for DVD)	13	■ <b>SETTINGS</b> .....	26
CONNECTING TO AN AMPLIFIER EQUIPPED WITH DIGITAL INPUT JACKS, MD DECK OR DAT DECK (for DVD) .....	13	CHANGING THE AUDIO LANGUAGE OR SOUND MODE .....	26
CONNECTING TO A DOLBY DIGITAL DECODER OR DTS DECODER (for DVD) ..	14	CHANGING THE SUBTITLE LANGUAGE ..	27
<b>TV SECTION</b>		CHANGING THE CAMERA ANGLE (Multi-Angle Pictures) .....	27
■ <b>SET UP FOR USE</b> .....	15	CHANGING THE ON-SCREEN DISPLAY ..	28
LANGUAGE SELECTION .....	15	■ <b>CHANGING THE SETUP ITEMS</b> .....	29
CHANNEL PRESETTING .....	15	LANGUAGE SETTINGS .....	29
■ <b>OPERATIONS</b> .....	16	VIDEO SETTINGS .....	30
WATCHING A TV PROGRAM .....	16	AUDIO SETTINGS .....	30
SELECTING THE SLEEP TIMER .....	16	PARENTAL LOCK .....	31
CLOSED CAPTION .....	16	OTHER SETTINGS .....	32
PICTURE ADJUSTMENT .....	17	■ <b>LANGUAGE CODE LIST</b> .....	33
V-CHIP SET UP .....	18	■ <b>TROUBLESHOOTING GUIDE</b> .....	34
<b>DVD SECTION</b>		■ <b>MAINTENANCE</b> .....	37
■ <b>ABOUT THE DISCS</b> .....	20	DISC HANDLING .....	37
PLAYABLE DISCS .....	20	■ <b>SPECIFICATIONS</b> .....	38
DISC TYPES .....	20	■ <b>WARRANTY</b> .....	<i>Back Cover</i>
SYMBOLS USED IN THIS MANUAL .....	20		
■ <b>PLAYING A DISC</b> .....	21		
PLAYING A DVD VIDEO OR AN AUDIO CD	21		
USING THE DVD MENUS .....	21		
USING THE TITLE MENU .....	22		

# FEATURES

## TV

- **Tinted, Bright Black Matrix Picture Tube**
- **181 Channel Selection**  
All VHF/UHF channels plus up to 125 cable channels.
- **PLL Frequency Synthesized Tuning**  
The latest PLL frequency synthesized electronic tuning system provides free and easy channel selection, and lets you tune directly to any channel using the channel number buttons (0~9 and +100-key) on the remote control.
- **On-Screen Function Display.**
- **Full-Function Remote Control**
- **Sleep Timer**
- **Closed Caption Decoder**  
You may view specially labeled (cc) TV programs, movies, news, prerecorded tapes, etc. with either a dialogue caption or text display added to the program.
- **Auto Shut Off Function**  
If there is no air signal input from the antenna terminal and no operation for 15 minutes, the TV will turn itself off automatically.
- **V-CHIP**  
Enables parents to prevent their children from watching inappropriate material on TV.

## DVD

- **Dolby Digital sound**  
This player can handle Dolby Digital surround sound having 5.1 channels when connected to a Dolby Digital decoder.
- **Still/fast/slow/step playback**  
Various playback modes are available including still pictures, fast forward/reverse, slow motion and step frames.
- **Random playback for audio CD**  
This player can shuffle the order of tracks to play them in random order.
- **Program playback for audio CD**  
You can program the order of tracks to play them in any desired order.
- **DVD menus in a desired language**  
You can display DVD menus in a desired language, if available on a DVD.
- **Screen saver/Auto power-off functions**  
The screen saver program starts when there is no input from the player for five minutes in the stop mode. When the screen saver program is activated for 30 minutes, the power is automatically turned off.
- **Subtitles in a desired language**  
You can select a desired language for the display subtitles, if that language is available on a disc.
- **Selecting a camera angle**  
You can select the desired camera angle, if a disc contains sequences recorded from different angles.
- **Choices for audio language and sound mode**  
You can select the desired audio language and sound mode, if different languages and modes are available on a disc.

- **Parental lock**  
You can set the control level to limit playback of discs which may not be suitable for children.
- **Automatic detection of discs**  
This player automatically detects if a loaded disc is DVD or audio CD.
- **On-screen display**  
Information about the current operation can be displayed on a TV screen, allowing you to confirm the currently active functions (such as program playback), on the TV screen using the remote control.
- **DTS (Digital Theater System)**  
Sound system different from Dolby Digital sound system
- **Search**  
Chapter search: Search for the chapter designated by user is possible.  
Title search: Search for the title designated by user is possible.  
Track search: Search for the track designated by user is possible.  
Time search: Search for the time designated by user is possible.
- **Repeat**  
Chapter: Repeated playback of the chapter of the disc being played is possible.  
Title: Repeated playback of the title of the disc being played is possible.  
Track: Repeated playback of the track of the disc being played is possible.  
Disc(audio CD): Repeated playback of the entire disc being played is possible.  
A-B: The part between A and B designated by user is possible.
- **Zoom**  
4-time magnified screen can be displayed.
- **Marker**  
The part designated by user can be called back.
- **Resume Play**  
User can resume to playback from the part at which the play was stopped.
- **SRS TruSurround**  
You can enjoy stereophonic virtual space on your existing stereo system.
- **Bit rate indication**
- **Dynamic range control**

This unit employs TruSurround system

**TruSurround<sup>™</sup>**  
by **SRS** (●) of SRS Labs, Inc. as virtual technology.

TruSurround and the (●) symbol are trademarks of SRS Labs, Inc.

TruSurround technology is incorporated under license from SRS Labs, Inc.

# OPERATING CONTROLS AND FUNCTIONS

**TV/DVD FRONT PANEL** [Fig. 1]

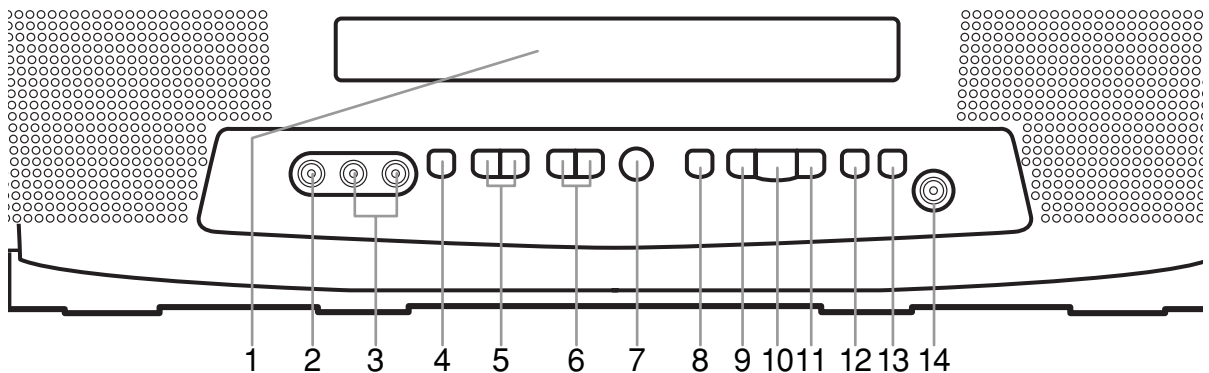

**REMOTE CONTROL** [Fig. 2]

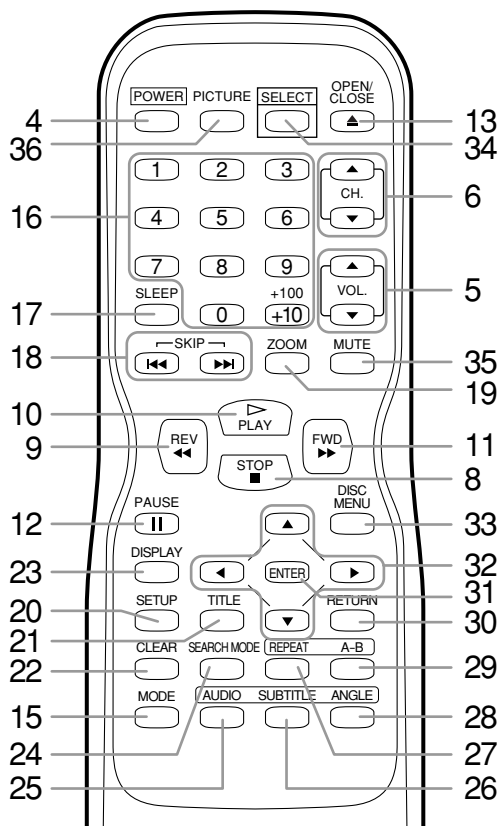

**1. Disc loading tray**

**2. VIDEO input jack**

Connect to the video output jack of a video camera or VCR.

**3. AUDIO L/R input jacks**

Connect to the audio output jacks of a video camera or VCR.

**4. POWER button**

Press to turn the power on and off.

**5. VOLUME  $\Delta/\nabla$  buttons**

Press to control the volume level for the DVD and TV.

**6. CHANNEL  $\blacktriangle/\blacktriangledown$  buttons**

Press to select memorized channel.

Press to change to TV mode when DVD mode.

**7. Remote Sensor Window**

**8. STOP button**

Stops operation of the disc.

**9. REV button**

Fast reverses playback to a desired point.

**10. PLAY button**

Starts playback of the disc contents.

Press to change to DVD mode when TV mode.

**11. FWD button**

Fast forwards playback to a desired point.

**12. PAUSE button**

Pauses the current disc operation.

**13. OPEN/CLOSE button**

Press to insert discs into or remove them from the tray.

**14. HEADPHONE jack**

To connect headphone (not supplied) for personal listening.

**15. MODE button**

Activates program playback or random playback mode.

**16. NUMBER button**

**TV Mode:**

Press two digits to directly access the desired channel.

Remember to press a "0" before a single digit channel.

**+100 button-**

Press to select cable channels which are equal or greater than number 100.

**DVD Mode:**

Press to enter the desired number.

**+10 button-**

Press to enter the desired numbers which are equal or greater than number 10.



**REAR VIEW**

[Fig. 3]

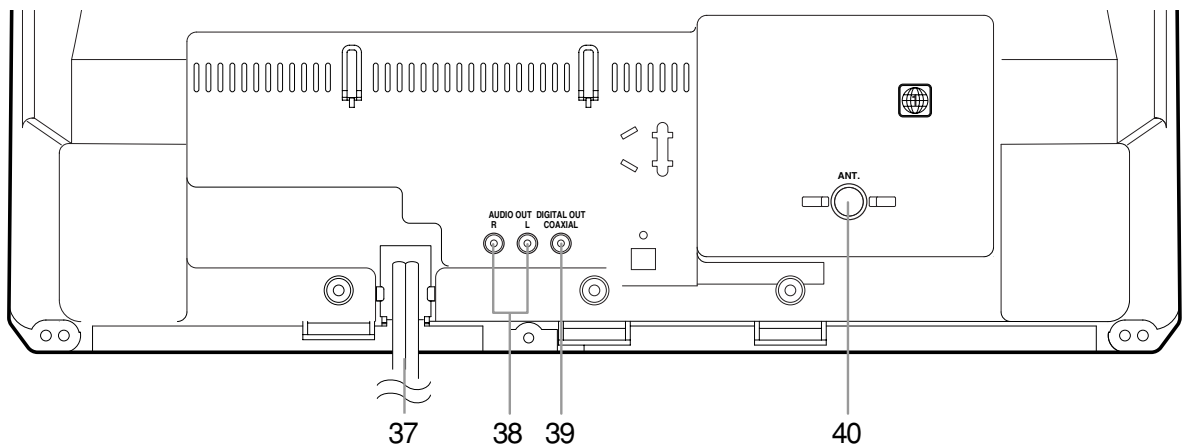
**17. SLEEP button**

Press the SLEEP button to display the sleep timer and start the function. The shut off time can be determined by the number of times you press the button. (0, 10, 20, 30,..90, 0 minutes)

**18. SKIP buttons**

Skip chapters or tracks to a desired point.

**19. ZOOM Button**

Expands the picture to fill the entire screen.

**20. SETUP button**

Press to enter or exit the TV menu or DVD setup mode.

**21. TITLE button**

Displays the title menu.

**22. CLEAR button**

Resets a setting.

**23. DISPLAY button****TV Mode:**

Press to display the channel number on the screen. If you press it again, the channel number will disappear.

**DVD Mode:**

Displays the current status on the TV screen for checking purposes.

**24. SEARCH MODE button**

Press to locate a desired point.

**25. AUDIO button**

Press to select a desired audio language or sound mode.

**26. SUBTITLE button**

Press to select a desired subtitle language.

**27. REPEAT button**

Repeats playback of the current disc, title, chapter or track.

**28. ANGLE button**

Press to change the camera angle to see the sequence being played back from a different angle.

**29. A-B REPEAT button**

Repeats playback of a selected section.

**30. RETURN button**

Returns to the previous operation.

**31. ENTER button**

Press to accept a setting.

**32. Arrow buttons****TV Mode:**

Press to select a setting mode from the menu on the TV screen.

Press to select or adjust from a particular menu.

**DVD Mode:**

Use when making settings while watching the display on a TV screen.

**33. DISC MENU button**

Displays the menus in the DVD.

**34. SELECT button**

Press to change to TV mode, external input mode or DVD mode.

**35. MUTE button**

Press the MUTE button to turn off the sound portion of the TV program. (Volume level display turns LIGHT RED from LIGHT BLUE.) Press the MUTE button again or press the VOL(ume) ▲ or ▼ button to restore sound.

**36. PICTURE button**

Press to enter picture adjustment mode.

**37. Power cord**

Connect to a standard AC outlet (120V/60Hz).

**NOTE:** Remove the power cord from the hook to avoid breaking a wire before you connect to a standard AC outlet.

**38. AUDIO L/R output jack**

Connect to the analog audio input of an external amplifier or decoder.

**NOTE:** The AUDIO output jacks (red/white) on the rear panel serve to give out DVD sound, not TV sound and external input sound.

**39. COAXIAL digital audio out jack**

Connect to the digital input of an external amplifier or decoder.

**40. ANT. in jack**

Connect to an antenna, cable system, or satellite system.

# PREPARATION FOR USE

## ANTENNA/CABLE CONNECTIONS

### VHF/UHF COMBINED ANTENNA

The VHF/UHF Rod Antenna (not supplied) is detachable. Insert the stem of the antenna into the hole on the upper-back portion of the TV/DVD. Connect the VHF/UHF Rod Antenna or VHF/UHF Combination Antenna to the ANT. terminal of the TV/DVD as shown in the diagram below. For the best reception, fully extend the VHF/UHF Rod Antenna and make the necessary adjustments. (Avoid touching the top section when adjusting.)

#### NOTE:

Before plugging the Rod antenna into antenna terminal, check that the pin is not bent. If it is bent, straighten the pin as illustrated, then plug the pin into antenna terminal.

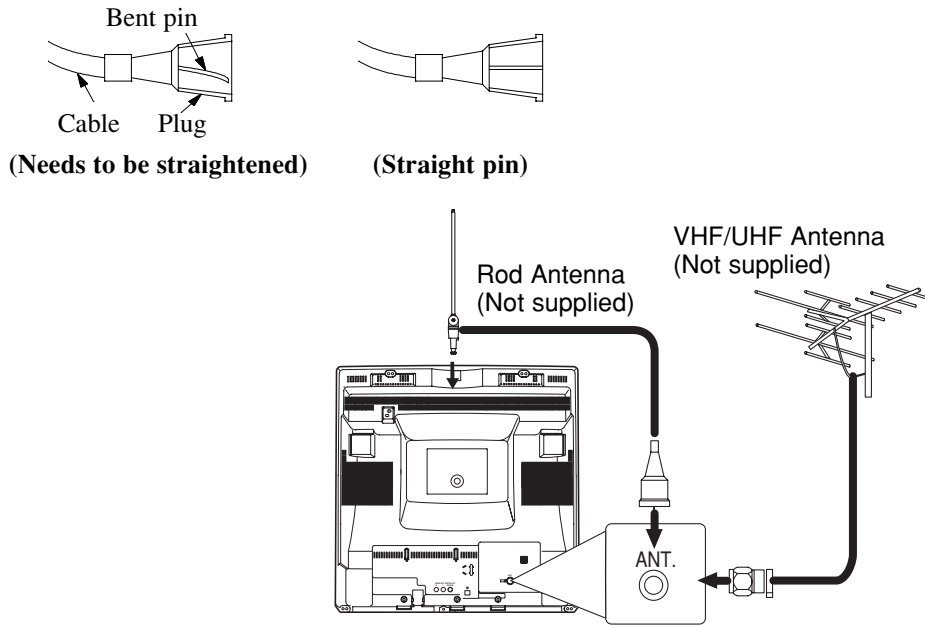

[Fig. 4]

#### NOTE:

The connection of an indoor antenna may not always give acceptable TV reception.

### VHF/UHF SEPARATE ANTENNAS

In some areas it will be necessary to use an outdoor antenna.

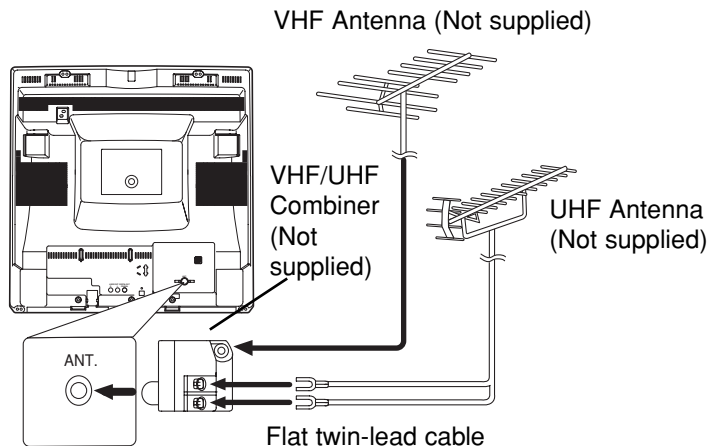

[Fig. 5]

## ***CABLE WITHOUT CONVERTER/ DESCRAMBLER BOX***

Use this connection if your cable system connects directly to your TV/DVD without a converter box.

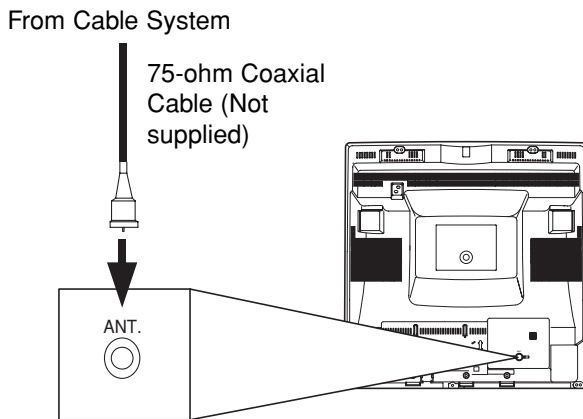

[Fig. 6]

## ***CABLE WITH CONVERTER/ DESCRAMBLER BOX OR SATELLITE BOX***

If your cable service supplies you with a converter box or if you use a satellite system, you can use the basic connection shown here.

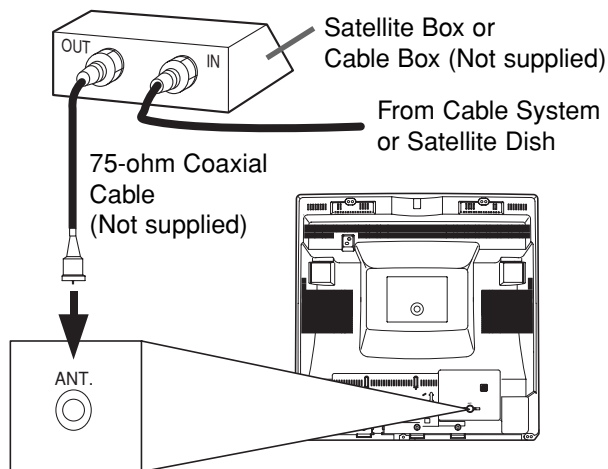

[Fig. 7]

### **Note to CATV system installer:**

This reminder is provided to call the CATV system installer's attention to Article 820-40 of the NEC that provides guidelines for proper grounding and, in particular, specifies that the cable ground shall be connected to the grounding system of the building as close to the point of cable entry as practical.

## INSTALLING THE BATTERIES

- 1) Open the battery compartment cover by pressing the cover on the remote unit in the direction of the arrow.
- 2) Insert 2 "AA" penlight batteries into the battery compartment in the direction indicated by the polarity (+/-) markings.
- 3) Replace the cover.

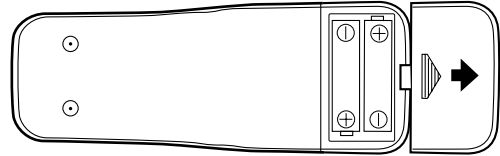

## CONNECTING TO EXTERNAL INPUT JACKS

When you watch a program recorded on another source (VCR or video camera), use the audio/video input jacks on the front of the TV/DVD.

Connect the audio/video output jacks of another source to the AUDIO L/R and VIDEO jacks of this TV/DVD. Then press the SELECT button until "VIDEO" appears on the screen.

### NOTE:

- When you connect a monaural VCR (another source) to this TV/DVD, connect the Audio output jack of the monaural VCR (another source) to the AUDIO L jack of this TV/DVD. The audio will output in both L and R channel equally.

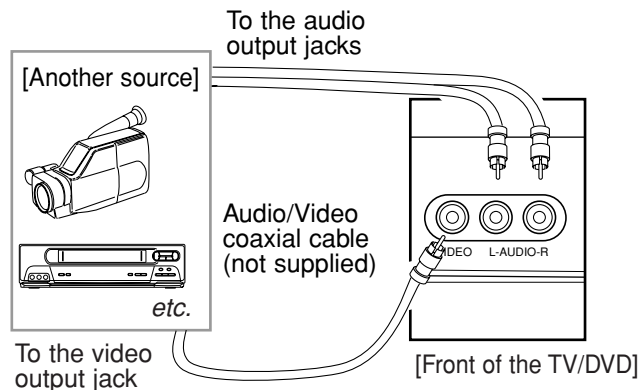

[Fig. 8]

Antenna/Cable Connections Continued on the Next Page.

## CONNECTING TO A STEREO SYSTEM (for DVD only)

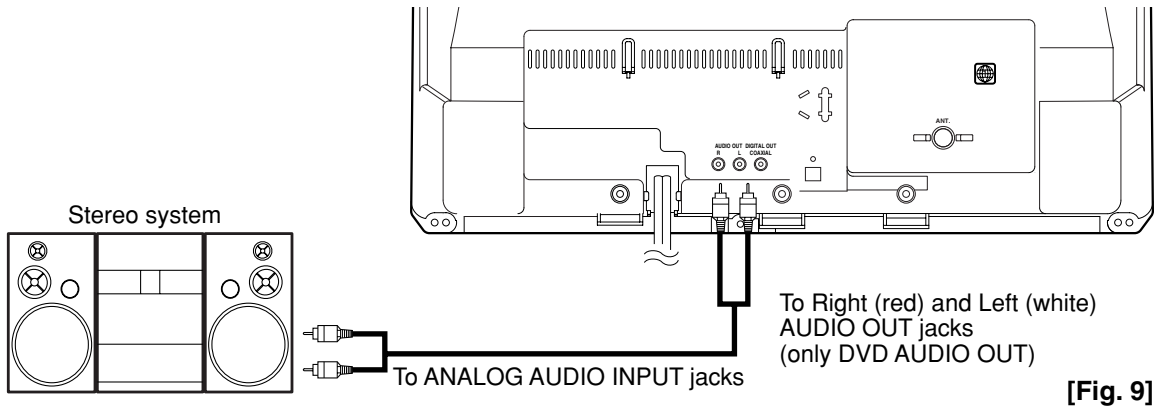

### NOTES:

- Be sure to turn off the power to all components in the system before connecting another component.
- Refer to the Owner's Manuals for your, stereo system and any other components to be connected to the TV/DVD.
- The AUDIO output jacks (red/white) on the rear panel serve to give out DVD sound, not TV sound and external input sound.

## CONNECTING TO AN AMPLIFIER EQUIPPED WITH DIGITAL INPUT JACKS, MD DECK OR DAT DECK (for DVD only)

Use an audio coaxial digital cable (commercially available) for the audio connections.

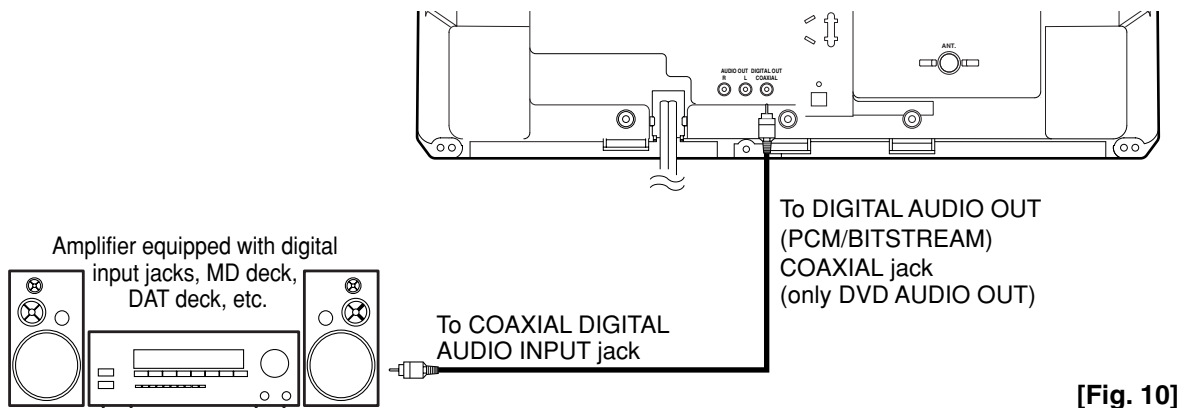

### NOTES:

- The audio source on a disc in a 5.1 channel Dolby Digital surround format cannot be recorded as digital sound by an MD or DAT deck.
- Be sure to turn off the power to all components in the system before connecting another component.
- Refer to the Owner's Manuals for the components to be connected to the TV/DVD.
- Set DOLBY DIGITAL and DTS to OFF for audio output in the setup mode. Playing a TV/DVD using incorrect settings may generate noise distortion, and may also damage the speakers.
- When DOLBY DIGITAL is set to OFF and VIRTUAL 3D to ON for audio output in the setup mode and you select the audio source in a 5.1 channel Dolby Digital surround format, the audio will be muted.

## CONNECTING TO A DOLBY DIGITAL DECODER OR DTS DECODER (for DVD)

If using this TV/DVD to play back a TV/DVD in a 5.1 channel Dolby Digital surround or DTS surround format, the TV/DVD outputs a Dolby Digital or DTS data stream from its COAXIAL digital audio out jack. By hooking the player up to a Dolby Digital or DTS decoder, you can enjoy a more convincing, realistic ambience with powerful and high-quality surround sound of a professional standard such as can be heard in movie theaters.

Use audio coaxial digital cables (commercially available) for the audio connections.

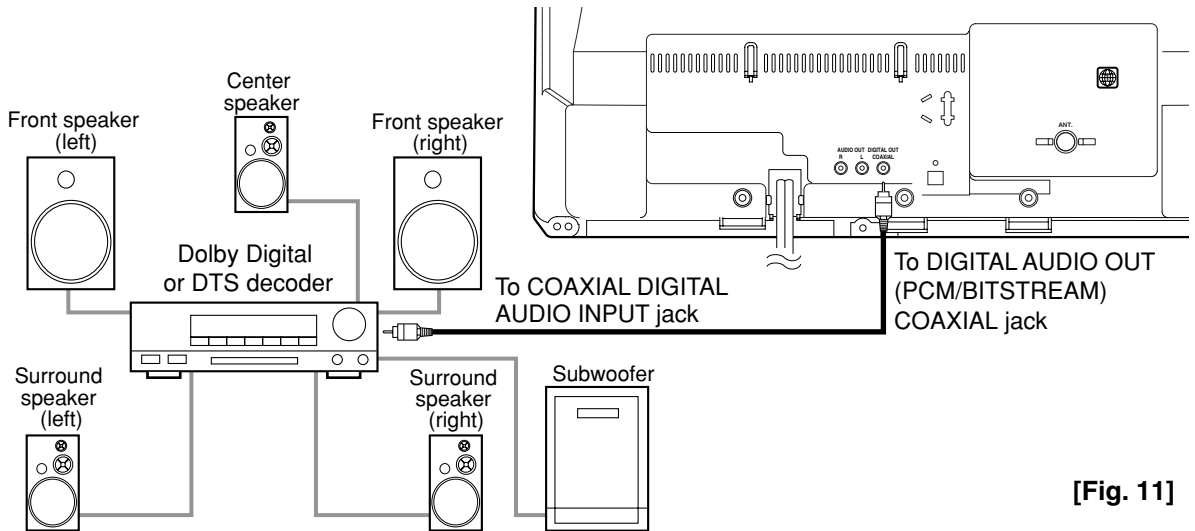

[Fig. 11]

### NOTES:

- Be sure to turn off the power to all components in the system before connecting another component.
- Refer to the Owner's Manuals for the components to be connected to the TV/DVD.
- If connected to a Dolby Digital decoder, set DOLBY DIGITAL to ON for audio output in the setup mode.
- If connected to a DTS decoder, set DTS to ON for audio output in the setup mode.
- Unless connected to a Dolby Digital decoder or a DTS decoder, set DOLBY DIGITAL and DTS to OFF for audio output in the setup mode. Playing a TV/DVD using incorrect settings may generate noise distortion, and may also damage the speakers.
- When DOLBY DIGITAL is set to OFF and VIRTUAL 3D to ON for audio output in the setup mode and you select the audio source in a 5.1 channel Dolby Digital surround format, the audio will be muted.

Manufactured under license from Dolby Laboratories. "Dolby" and the double-D symbol are trademarks of Dolby Laboratories.

"DTS" and "DTS Digital Out" are trademarks of Digital Theater Systems, Inc.

## SET UP FOR USE

## Getting started

1

Connect the power cord to a standard AC outlet.

**NOTE:** If some digits appear in the corner of the screen, press the POWER button without unplugging the power cord.

2

Press the POWER button to turn on the TV/DVD.

3

Press the SELECT button on the remote control until channel number or "TV" appears on the screen.

2

Press the Arrow ▲ or ▼ button to point to "CHANNEL SET". Then, press the Arrow ► button.

► CHANNEL SET  
LANGUAGE [ENGLISH]  
ESPAÑOL  
FRANÇAIS  
V-CHIP SET UP  
CAPTION [OFF]

3

Press the Arrow ▲ or ▼ button to point to "AUTO MEMO". Then, press the Arrow ► button. The tuner scans and memorizes all active channels in your area.

ADD/DELETE  
► AUTO MEMO

- The TV distinguishes between standard TV channels and cable channels.
- When AUTO MEMO action is completed, the lowest memorized channel reappears on the screen.
- When you press the Arrow ▲ or ▼ button after selecting AUTO MEMO, the tuner will stop at the memorized channels only.
- The TV/VCR may memorize TV channels as CATV channels if reception conditions are poor. If this happens, try the AUTO MEMO action again when reception conditions are better.

## LANGUAGE SELECTION

If you want to change the language of the on-screen menu, follow the procedure below.

1

Press the SETUP button so that the setup display appears on the TV screen.

► CHANNEL SET  
LANGUAGE [ENGLISH]  
ESPAÑOL  
FRANÇAIS  
V-CHIP SET UP  
CAPTION [OFF]

2

Press the Arrow ▲ or ▼ button to point to "LANGUAGE".

CHANNEL SET  
► LANGUAGE [ENGLISH]  
ESPAÑOL  
FRANÇAIS  
V-CHIP SET UP  
CAPTION [OFF]

3

Select "ENGLISH", "ESPAÑOL" = Spanish or "FRANÇAIS" = French by using the Arrow ◀ or ▶ button.

## [ADD/DELETE FUNCTION]

1) Press the SETUP button so that the setup display appears on the TV screen.

2) Press the Arrow ▲ or ▼ button to point to "CHANNEL SET". Then, press the Arrow ► button.

► CHANNEL SET  
LANGUAGE [ENGLISH]  
ESPAÑOL  
FRANÇAIS  
V-CHIP SET UP  
CAPTION [OFF]

3) Press the Arrow ▲ or ▼ button to point to "ADD/DELETE". Then press the Arrow ► button.

► ADD/DELETE  
AUTO MEMO

4) Use the Arrow ▲ or ▼ button to select the channel you wish to put into memory or to erase from memory.

**NOTE:** The display will return to the screen in about 10 seconds. Perform "ADD/DELETE" function while this display appears on the screen.

- Press the Arrow ◀ or ▶ button to light up the channel number in LIGHT BLUE if you wish to add the channel into memory.
  - Press the Arrow ◀ or ▶ button to light up the channel number in LIGHT RED if you wish to erase the channel from memory.
- 5) Press the SETUP button to exit the setup.

## CHANNEL PRESETTING

To preset a channel or to change a preset channel, follow the procedure below.

1

Press the SETUP button so that the setup display appears on the TV screen.

► CHANNEL SET  
LANGUAGE [ENGLISH]  
ESPAÑOL  
FRANÇAIS  
V-CHIP SET UP  
CAPTION [OFF]

# OPERATIONS

## WATCHING A TV PROGRAM

1

Select the desired channel with the CH(annel) ▲ or ▼ button.

2

Adjust the volume to the desired listening level using the VOL(ume) ▲ or ▼ button.

3

Adjust picture controls for a natural looking image. (See "PICTURE ADJUSTMENT".)

**Note:** Suppose that the TV/DVD is shut off or in any other mode than TV. Press the CHANNEL ▲ or ▼ button on the TV/DVD, and the TV/DVD will be in the TV mode to watch television.

## SELECTING THE SLEEP TIMER

The sleep timer function enables you to shut off the power without pressing the POWER button after a desired time period.

1

Press the SLEEP button on the remote control.

2

You may change the sleep time with pressing the SLEEP button on the remote control repeatedly. The timer is set up to 90 minutes, 10 minutes each time the SLEEP button is pushed. (The timer display counts up and sleep timer will be displayed on the screen when you press the SLEEP button on remote control.)



### To cancel the sleep timer:

Press the SLEEP button repeatedly until "SLEEP 0" is displayed.

### NOTES:

- When you disconnect the unit from the AC outlet, or if you have a power failure, the sleep time will be lost.
- When the TV mode is changed to the DVD mode, the sleep time will be lost.

## DEGAUSSING

Magnetism from nearby appliances might affect the color of the TV picture.

If this happens, move this unit away from the appliance. If the color is still not correct, disconnect power cord from AC outlet then reconnect it after 30 minutes.

## CLOSED CAPTION

This TV can receive C1 and C2 of Caption and Text.

### CAPTION MODE

1) Characters can be displayed on the TV screen when the received broadcast signal contains the Caption Signals.

2) **Paint-on mode:** Displays input characters on the screen immediately.

**Pop-on mode:** Once characters are stored in memory, it is displayed all at once.

**Roll-up mode:** Displays the characters continuously by scrolling (max. 4 lines)

**NOTE:** If the CAPTION C1 or C2 is selected but the caption signal is not included, characters will not be displayed.

### TEXT MODE

1) Displays the text on the screen by scrolling (max. 7 lines)

2) If the received broadcast signal does not contain the caption or text signal, no change will occur.

### NOTES:

1) When your TV receives a special effects playback signal (i.e., Search, Slow, Still) from a VCR's video output channel (CH3 or CH4), your TV may not display the correct caption or text.

2) Captions and texts may not match the TV voice exactly.

3) Interference may cause the closed caption system not to function properly.

4) The caption or text characters will not be displayed while the setup display or function's display is shown.



## 5) If you see this screen!!

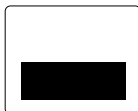

If your TV displays a black box on the screen, this means that your TV is set to TEXT mode. To clear screen, select CAPTION C1, C2 or CAPTION [OFF].

## CLOSED CAPTION SELECTION

You may view specially labeled (cc) TV programs, movies, news, prerecorded tapes, etc. with either a dialogue caption or text display added to the program.

1

Press the SETUP button so that the setup display appears on the TV screen.

2

Press the Arrow ▲ or ▼ button to point to "CAPTION".

3

Press the Arrow ► or ◀ button to select the mode you wish.

4

When done, press the SETUP button to exit the setup.

◀ ▶ : Press the Arrow ► or ◀ button.

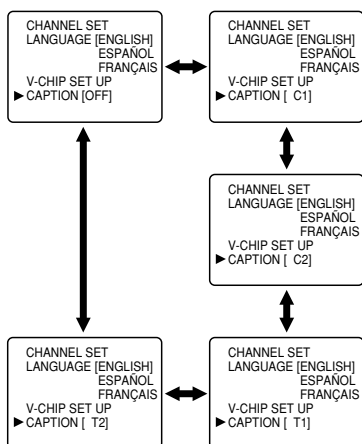

## PICTURE ADJUSTMENT

1

Press the PICTURE button.

2

Select the feature you wish to adjust with the Arrow ▲ or ▼ button and adjust it with the Arrow ► or ◀ button.

## GAME MODE

Set to the most suitable position for TV GAME.

[►] : ON

[◀] : OFF

## BRIGHT

Adjust until the whitest parts of the picture are as bright as you prefer.

[►] : increase brightness

[◀] : decrease brightness

## CONTRAST

Adjust to increase or decrease contrast.

[►] : increase contrast

[◀] : decrease contrast

## COLOR

Adjust to be brilliant or pale color.

[►] : be brilliant color

[◀] : be pale color

## TINT

Adjust to obtain natural skin tones.

[►] : greenish tone

[◀] : reddish tone

## NOTES:

- In the above steps, the picture adjustment display will disappear from the TV screen after about 10 seconds unless you press any buttons, even though you may not be finished. Press the SETUP and Arrow ► button so that "PICTURE" mode is selected. Then, press the Arrow ▲ or ▼ button repeatedly until the display returns to the screen.
- If you adjust the other Picture control after you set the Game mode to [ON], the Game mode is set to [OFF] automatically. If you want to set the Game mode, reset it to [ON].

▲ ▼ : Press the Arrow ▲ or ▼ button.

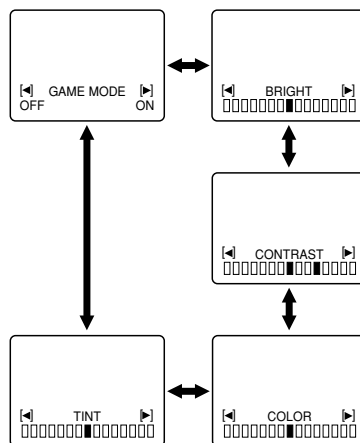

## V-CHIP SET UP

V-CHIP enables parents to prevent their children from watching inappropriate material on TV. V-CHIP reads the ratings for programming (except for news and sports programs, unedited movies on premium cable channels, and Emergency Broadcast System signals), then denies access to programming if the program's rating meets the limitations you select. In this case, "PROTECTED PROGRAM by ..." message appears on the TV screen. You can watch the protected program by entering access code (default 0000).

To block ratings, follow the steps below.

- Programming may be rated by the Motion Picture Association of America (MPAA) or according to the Television Parental Guidelines. In order to block any inappropriate programming, set your limits in both places (MPAA RATING and TV RATING).
- You cannot access the menu when the "PROTECTED PROGRAM by ..." message appears. In this case, change to the unblocked channel, then press the SETUP button.

### [MPAA RATING SET UP]

1

Press the SETUP button so that the setup display appears on the TV screen.

2

Press the Arrow ▲ or ▼ button to point to "V-CHIP SET UP". Then, press the Arrow ► button.



3

Use the number buttons to enter 4-digit access code. The default code is 0000.

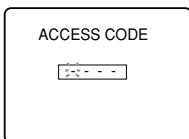

4

Press the Arrow ▲ or ▼ button to point to "MPAA RATING". Then, press the Arrow ► button.

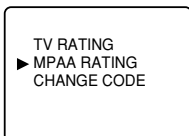

5

Press the Arrow ▲ or ▼ button to point to your desired item. Then, press the Arrow ► button to select [BLOCK] or [VIEW].

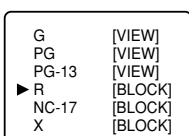

<Selection>	<Rating Category Explanations>
• G:	General Audience
• PG:	Parental Guidance suggested.
• PG-13:	Unsuitable for children under 13
• R:	Restricted; under 17 requires accompanying parent or adult guardian
• NC-17:	No one under 17 admitted
• X:	Mature audience only

- When you select the rating category and turn it [BLOCK], the higher rating will turn [BLOCK] automatically. Also, the lower rating will turn [VIEW] automatically.
- When you turn "G" to [BLOCK] or [VIEW], the all ratings will turn to [BLOCK] or [VIEW] automatically.
- When you turn "X" to [VIEW], the all ratings will turn to [VIEW] automatically.

5

Press the SETUP button to exit the setup.

### [TV RATING SET UP]

1

Press the SETUP button so that the setup display appears on the TV screen.

2

Press the Arrow ▲ or ▼ button to point to "V-CHIP SET UP". Then, press the Arrow ► button.

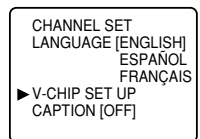

3

Use the number buttons to enter 4-digit access code. The default code is 0000.

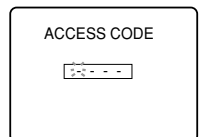

4

Press the Arrow ▲ or ▼ button to point to "TV RATING". Then, press the Arrow ► button.

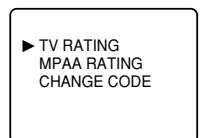

4

Press the Arrow ▲ or ▼ button to point to your desired item. Then, press the Arrow ► button to select [BLOCK] or [VIEW].

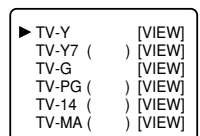

<Selection>	<Rating Category Explanations>
• TV-Y:	Appropriate for all children
• TV-Y7:	Appropriate for children seven and older
• TV-G:	General Audience
• TV-PG:	Parental Guidance suggested.
• TV-14:	Unsuitable for children under 14
• TV-MA:	Mature audience only

- When you select the rating category and turn it [BLOCK], the higher rating will turn [BLOCK] automatically. Also, the lower rating will turn [VIEW] automatically.
- When you turn "TV-Y" to [BLOCK] or [VIEW], the all ratings will turn to [BLOCK] or [VIEW] automatically.
- When you turn "TV-MA" to [VIEW], the all ratings will turn to [VIEW] automatically.

When you select TV-Y7, TV-PG, TV-14, or TV-MA and you press the Arrow ► button, the sub-ratings will appear on the TV screen.

If you select the rating category (example: TV-PG) and turn it [BLOCK] or [VIEW], the sub-ratings (example: V for Violence) will turn [BLOCK] or [VIEW] automatically.

You can set the sub-ratings to [BLOCK] or [VIEW] individually when the rating category is set to [BLOCK]. To set the sub-ratings individually, follow the steps below.

- **When you select [TV-Y7]:**  
Press the Arrow ▲ or ▼ button to select "FV" (Fantasy Violence). Then, press the Arrow ► button to select [BLOCK] or [VIEW].

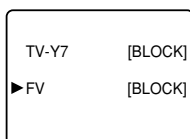

- **When you select [TV-PG], [TV-14] or [TV-MA]:**

Press the Arrow ▲ or ▼ button to select "D"(Suggestive Dialog), "L"(Coarse Language), "S"(Sexual Situation), or "V"(Violence). Then, press the Arrow ► button to select [BLOCK] or [VIEW].

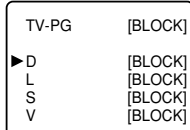

**NOTE:** When you select [TV-MA], "D" does not appear on the TV screen.

- The sub-ratings which set to [BLOCK] appears next to the rating category in the TV RATING menu.

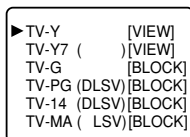

## [CHANGE ACCESS CODE]

To change access code, follow the steps.

1

Press the SETUP button so that the setup display appears on the TV screen.

2

Press the Arrow ▲ or ▼ button to point to "V-CHIP SET UP". Then, press the Arrow ► button.

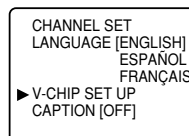

3

Use the number buttons to enter 4-digit access code. The default code is 0000.

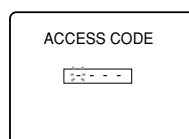

4

Press the Arrow ▲ or ▼ button to point to "CHANGE CODE". Then, press the Arrow ► button.

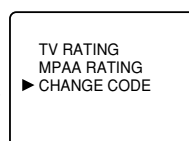

5

Use the number buttons to enter your desired access code in the NEW CODE space. Then enter the same code in the CONFIRM CODE space. V-CHIP SET UP screen appear on the screen.

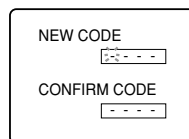

- If you enter wrong code, repeat step 5, making sure you enter the same new code exactly in the confirm code space.

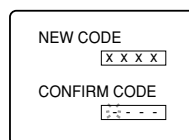

6

Press the SETUP button to exit the setup.

### Note:

- If you unplug the power cord or power failure occurs, the changed access code will be lost and will return to default (0000). Change your access code again as necessary.



5

Press the SETUP button to exit the setup.

**ABOUT THE DISCS**

**PLAYABLE DISCS**

The following discs can be played back on this DVD player.

Disc Type	Logo	Contents	Disc Size	Maximum Playback Time
DVD Video		Sound and Pictures	12 cm	Approx. 4 h (single-sided) Approx. 8 h (double-sided)
			8 cm	Approx. 80 min (single-sided) Approx. 160 min (double-sided)
Audio CD		Sound	12 cm	74 min
			8 cm (singles)	20 min

This player conforms to the NTSC color system. You cannot play discs recorded in other color systems such as PAL or SECAM.

- Some discs include region codes as shown below.



- The number inside the symbol refers to a region of the world, and a disc encoded in a specific region format can only be played back on DVD players with the same region code.

The following discs cannot be played back on this DVD player.

- DVD with region codes other than 1 or ALL.
- DVD-ROM
- DVD-RAM (Never play back, otherwise malfunction may result.)
- CD-ROM
- VSD
- CDV (Only plays back the audio part.)
- CD-G (Only plays back the sound.)
- CD-R (Never play back, otherwise malfunction may result.)
- CD-I (Never play back, otherwise malfunction may result.)

- Photo CD (Never play back, otherwise malfunction may result.)
- Video CD (Never play back, otherwise malfunction may result.)

*Any other discs without compatibility indications*

**DISC TYPES**

**[DVD]**

Data on a DVD is divided into sections called "titles", and then into subsections called "chapters", each of which is given a title or chapter number. Playback conditions are preset on some DVD video discs, and these playback conditions take priority over user operations on this player. If a function you selected do not run as desired, refer to the manual accompanying the disc.

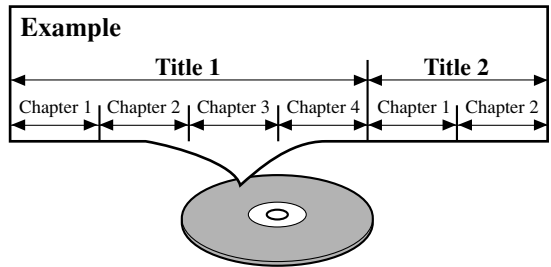

**[AUDIO CD]**

Data on an audio CD is divided into sections called "tracks", each of which is given a track number.

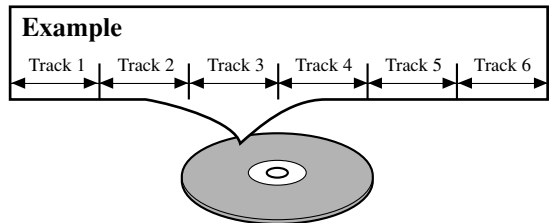

# PLAYING A DISC

## PLAYING A DVD VIDEO OR AN AUDIO CD

DVD CD

### Getting started

Turn on the power of the TV/DVD, amplifier and any other components.

#### 1 Press the POWER button.

- The power will turn on.

#### 2 Press the OPEN/CLOSE button.

- The disc loading tray will open.

#### 3 Place a disc into the tray.

- Make sure the disc is sitting properly in the correct recess, with the label side up.

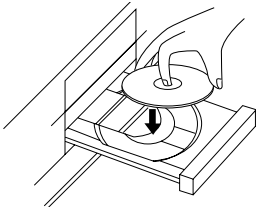

#### 4 Press the PLAY button.

- The tray will close automatically, and playback will then start from the first chapter or track of the disc. You need to press the PLAY button only when the tray has been closed by pressing the OPEN/CLOSE button.
- When you play back the DVD which a title menu is recorded, the menu may appear on the screen. In this case, refer to "USING THE TITLE MENU".

#### 5 Press the STOP button to stop play.

### Notes

- When the DVD mode has been switched to the TV mode, the DVD mode shut down first and then TV picture and sound appears in about 4 seconds. Similarly, when the POWER button is pressed off in the DVD mode, this mode shut down first and then the set's power is turned off.
- A "prohibited icon" may appear at the top-right on the TV screen during operation, warning that a prohibited operation has been encountered by the DVD player or the disc. 
- If a disc is dirty or has scratches, the pictures may appear distorted and the playback operation may stop. In such cases, clean the disc and unplug the power cord and then plug it again before resuming playback.
- With DVDs that use some titles for playback program signals, playback may start from the second title, or it may skip these titles.

## USING THE DVD MENU

DVD

Some DVDs contain their own menus, such as a guidance menu which describes the contents of the disc or a selection menu for sound, language and other customized settings.

#### 1 Press the DISC MENU button.

- The DVD menu will appear.

#### 2 Select the desired title.

- Press the arrow buttons (▼/▲/▶/◀) to change the setting, and then press the ENTER button.

#### 3 Playback will start from the selected title.

## USING THE TITLE MENU

DVD

With a DVD containing a title menu, you can select desired titles from the menu.

### 1 Press the TITLE button.

- The title menu will appear.

### 2 Select the desired title.

- Press the arrow buttons (▼/▲/▶/◀) to change the setting, and then press the ENTER button.

## CALLING UP A MENU SCREEN DURING PLAYBACK

### For DVDs

- Press the DISC MENU button to call up the DVD menu.
- Press the TITLE button to call up the title menu.

### Note

- Contents of menus and corresponding menu operations may vary between discs. Refer to the manual accompanying the disc for details.

## PAUSING PLAYBACK OR DISPLAYING A STILL PICTURE

DVD

CD

### 1 Press the PAUSE button during playback.

- Playback will pause, with sound muted.

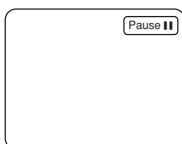

### 2 Press the PLAY button to resume playback.



## RESUMING PLAYBACK FROM THE POINT WHERE PLAYBACK STOPPED

DVD

CD

### 1 Press the STOP button during playback.

- Playback will stop, and then appear the resuming message at the center.

Press 'PLAY' to play from here  
To play beginning, press 'STOP' first  
and the 'PLAY'.

### 2 Press the PLAY button. Playback will start from the point where the previous playback session was stopped.



### Notes

- Resuming playback is not available with some discs.
- If you switch to the TV mode during DVD playback, the resuming
- It is possible to switch from the DVD play mode to the TV mode. Even if the power is turned off, the resume function enables to playback on from the previously interrupted point. But note that the Marker commands are not saved.
- The resume function can be reset by pressing the STOP button twice or by opening the disc loading tray.

## STEPPING THROUGH FRAMES

DVD

### 1 Press the PAUSE button while playback is paused.

- The next picture frame is displayed with sound muted each time the button is pressed.

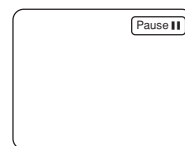

### 2 Press the PLAY button to resume playback.



## FAST FORWARD/REVERSE

DVD CD

1 Press the FWD ►► or REV ◄◄ button during playback.

- For DVDs, pressing the FWD ►► or REV ◄◄ button cycles the playback speed in three steps.
- For audio CDs, the playback speed is  $\times 16$  fixed.

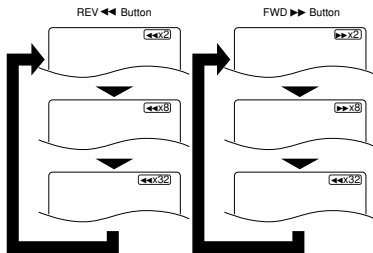

2 Press the PLAY button to return to normal playback speed.

## SLOW MOTION

DVD

1 Press the FWD ►► button while playback is paused. (Sound remains muted.)

- Slow motion mode will be activated.
- Pressing the FWD ►► button cycles the playback speed in three steps. Select an appropriate speed while referring to the speed indication on the screen.

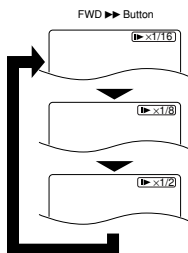

2 Press the PLAY button to return to normal playback speed.

### Notes

- Slow playback is not available with audio CDs.
- The reverse of slow playback is not available.

## STARTING FROM A DESIRED TRACK

CD

1 Press the numeric buttons to enter the desired track number.

- The selected track will be located, and playback will start. You can also press the SEARCH MODE button, use the numeric buttons to enter the track number, when the track number is entered in the entry box, playback of the desired track will start automatically.

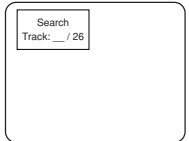

### TRICKS WITH THE SKIP BUTTONS (◄◄, ►►)

If the SKIP button ►► is pressed during playback or while playback is paused, the current track is skipped and the next track is played. When the SKIP button ◄◄ is pressed once, the top of the current track is located for replaying. When the SKIP button ◄◄ is pressed again while Within 2-second playback, the previous track is located.

## STARTING FROM A DESIRED TIME COUNT

DVD CD

1 Press the SEARCH MODE button.

- Press the button twice for DVDs or two times for audio CDs.

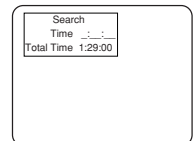

2 Press the numeric buttons to set the desired time count.

- **Example:** 1 hour, 23 minutes and 30 seconds  
1 → 2 → 3 → 3 → 0

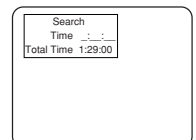

### Notes

- In the case of DVD, Time Search in Title is effective. (But Time Search in Chapter is ineffective.)
- In the case of CD, Time Search in Track is effective. (But Time Search in the entire disc is ineffective.)
- Playback from a desired time count is not available with some discs.
- Specific time playback is not available with some discs or if the unit is in stop mode.

## PLAYING FROM A DESIRED TITLE OR CHAPTER

DVD

You can also press the SEARCH MODE button, use the numeric buttons to enter the chapter number.

- Perform the title search and the chapter search after setting them on the same screen at the same time. Changeover by ▲/▼ buttons.

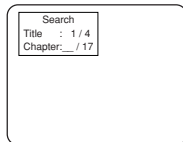

### Note

- Playback from a desired title or chapter is not available with some DVDs.

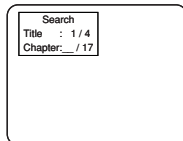

## RANDOM (Audio CD)

CD

1 Press the MODE button in stop mode.

- The program setting menu screen will appear.

2 Press the MODE button again.

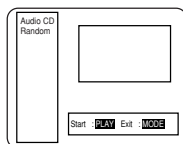

3 Press the PLAY button. Random playback will then start.

### Note

- Program playback is not available during random playback.

## REPEAT

DVD

CD

1 Press the REPEAT button.

### For DVDs

- A single title or chapter is played back repeatedly.
- Pressing the REPEAT button cycles the display on the screen as follows.

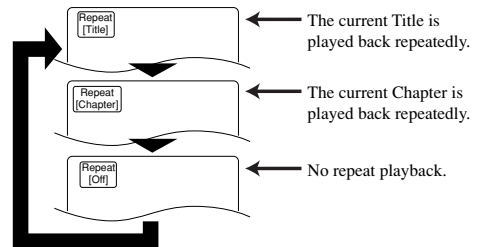

### For audio CDs

- The whole disc or a single track is played back repeatedly.
- Pressing the REPEAT button cycles the display on the screen through **All**, **Repeat Track** and **Off**.

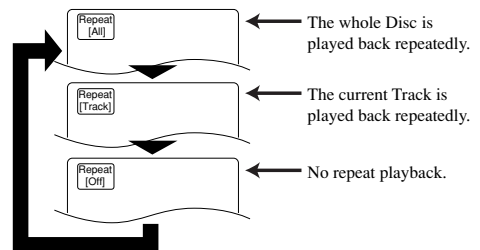

**If the REPEAT button is pressed once during program/random playback, the program/random playback is performed repeatedly.**

**If the REPEAT button is pressed again, the current track is played back repeatedly.**

### Notes

- Repeat playback is not available with some discs.
- The REPEAT setting will be cleared when moving to other title, chapter or track.



## A-B REPEAT

DVD

CD

You can define a section to be played back repeatedly.

### 1 Press the A-B REPEAT button during playback.

- The starting point (A) will then be selected.

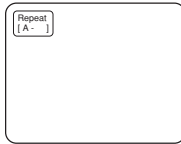

### 2 Press the A-B REPEAT button again at the end point (B) of the desired section.

- The selected section will be played back repeatedly.

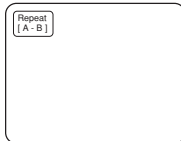

### 3 To exit A-B repeat playback, press the A-B REPEAT button and set it to OFF.

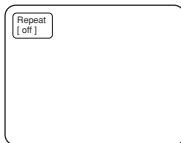

#### Notes

- With DVDs, the A-B repeat section can be set only within the current title.
- With audio CDs, the A-B repeat section can be set within the current track.
- A-B repeat is not available with some scenes in DVD.
- To cancel the A point which was set, press RETURN button.

## PROGRAM (Audio CD)

CD

### 1 Press the MODE button in stop mode.

- The program screen will appear.

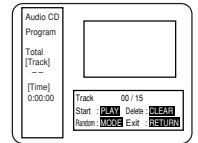

### 2 Press the numeric buttons to enter the desired track numbers.

- The total playback time for the selected tracks will appear on the TOTAL line.

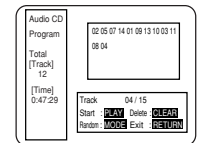

### 3 Press the PLAY button.

- Playback will start in the programmed order.
- While the program is being played back, the STOP button works as follows.
- Press the STOP button once and then the PLAY button again, playback will restart from the point where the STOP button was pressed. (Program continued)
- Press the STOP button twice and then the PLAY button again, playback will restart from the first tune in the program in the usual way. (Program continued)
- Press the STOP button three times and then the PLAY button again, playback will restart from the track in the usual way. (Program cleared)

#### Notes

- Adding programs is not possible during program playback. You must stop the current playback before such operations can be carried out.
- Press the CLEAR button to cancel a program. The most recently entered program will then be deleted.
- Numbers which exceed the number of tracks on the disc in the tray are not accepted.
- Playback from a desired track and random playback are not available during program playback.
- Program settings are cleared when the power is turned off or the disc loading tray is opened.
- If the track no. is once set in the program, the setting cannot be changed.

# SETTINGS

## ZOOM PLAYBACK (enlargement onscreen)

DVD

Images can be enlarged four times on the screen to your taste.

Press the ZOOM button during playback.

- An image will be enlarged at the center of the screen.
- Press the ZOOM button again, and the image will be back to the previous size.

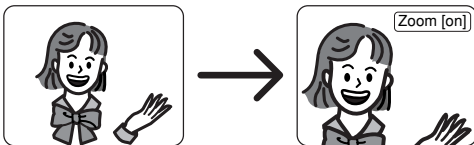

When the cursor (▲/▼/◀/▶) button is pressed during zoom play, the part to be zoomed moves.

- The zooming frame can be moved from the center .... 4 steps to the right. 4 steps to the left. 4 steps to the top. 4 steps to the bottom.

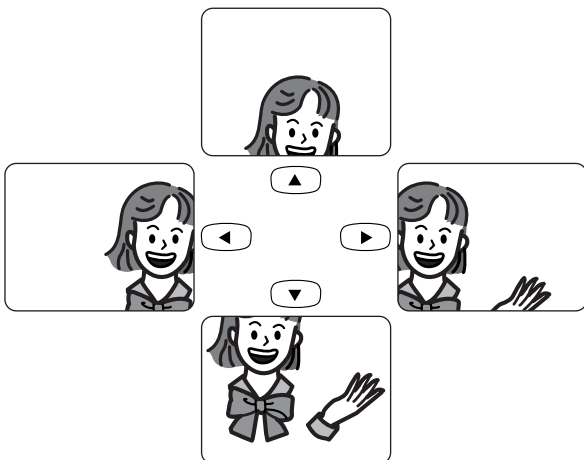

### Note

- Zooming function does not work while operation display screen is shown.

## CHANGING THE AUDIO LANGUAGE OR SOUND MODE

DVD

The DVD player has a function which allows you to select the desired audio language and sound mode.

### For DVDs

Press the AUDIO button during playback, and then press the AUDIO button to select the desired audio language.

- The audio language can be changed if multiple languages are recorded on the DVD being played.

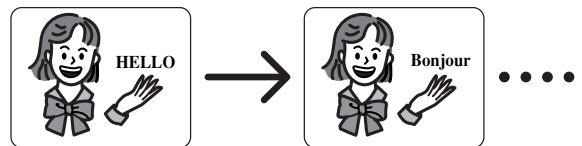
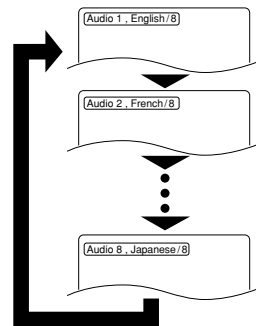

### Notes

- Pressing the Audio button may not work on some DVDs with multiple audio languages (e.g. DVDs which allow audio language setting on the disc menu). Operation varies between discs, so refer to the manual accompanying the disc.
- If a desired language is not shown after pressing the Audio button several times, the disc does not have an audio source in that language.
- The audio language resets to the one which has been selected in the setup mode, every time the power is turned on or discs are replaced. If that language is not available on a disc, a language defined by the disc is selected.
- The screen display will disappear after about 5 seconds.

## CHANGING THE SUBTITLE LANGUAGE

DVD

The DVD player has a function which allows you to select the desired language for subtitles.

Press the **SUBTITLE** button during playback, and then press the **SUBTITLE** button to select the desired subtitle language.

- The subtitle language can be changed if the subtitles are recorded in multiple languages on the DVD being played.
- The subtitle language cannot be changed if the subtitles are recorded in a single language on the DVD being played.

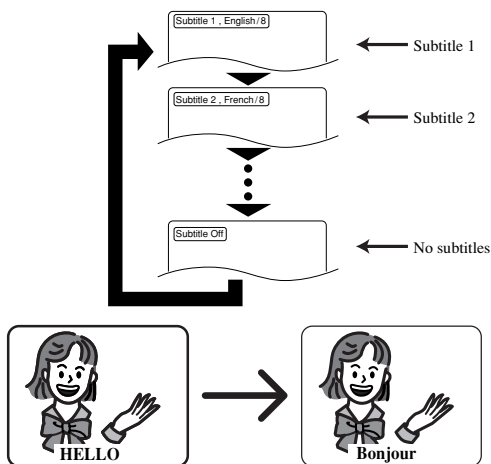

- Pressing the **SUBTITLE** button cycles the subtitle language from **SUBTITLE 1**, **SUBTITLE 2** and all the languages recorded through to off.

### Notes

- Some discs allow subtitle language setting on the disc menu. (Operation varies between discs, so refer to the manual accompanying the disc.)
- If the desired language is not shown after pressing the **SUBTITLE** button several times, the disc does not have subtitles in that language.
- The subtitle language resets to the one which has been selected in the setup mode, every time the power is turned on or discs are replaced. If that language is not available on a disc, a language defined by the disc is selected.
- It may take time to display the subtitles in the selected language.
- The screen display will disappear after about 5 seconds.
- When “Subtitle Not Available” appears onscreen, it means no subtitle is recorded on the scene.

## CHANGING THE CAMERA ANGLE (Multi-Angle Pictures)

DVD

The DVD player has a function which allows you to select the desired camera angle.

1 Press the **ANGLE** button during playback.

- If the disc contains sequences recorded from different camera angles, the angle icon (  ) will appear at the top-right of the screen. You can change the camera angle when the icon appears on the screen.
- The camera angle cannot be changed if the disc does not contain sequences recorded from different camera angles.

2 Press the **ANGLE** button while the angle number is shown on the screen.

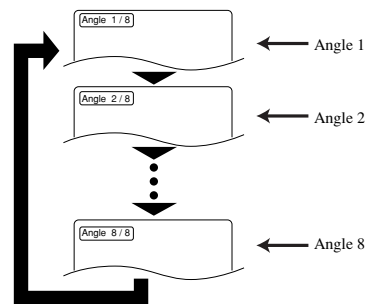

### Note

- The screen display will disappear after about 5 seconds.

# CHANGING THE ON-SCREEN DISPLAY

DVD CD

You can check the information about the disc by pressing the DISPLAY button on the remote control.

## For audio CDs and DVDs

1

Press the DISPLAY button, the display appears on the screen.

2

For the selecting the item of the Playback Setup Window, press the ▲/▼ button to select the item, then press the ENTER button.

## For audio CDs

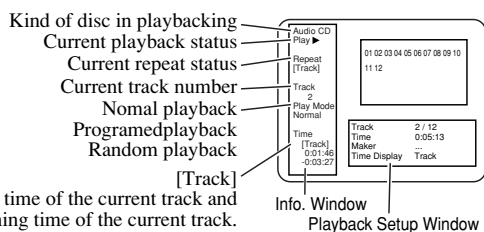

Elapsed time of the current track and Remaining time of the current track.

[All]

Elapsed time of the current disc and Remaining time of the current disc.

## Playback Setup Window (CD)

ITEM	DISPLAY CONTENTS
Track	Current track number / the number of total tracks
Time	Total time of the current track
Marker	<p>Place the cursor and press the ENTER button to activate the Marker function. [Set the marker]</p> <p>Using ▲/▼ button, position the cursor on to the marker number shown as “Not Set”. Press the ENTER button when the screen to be reviewed appears. Up to 5 points can be marked.</p> <p>[Call back the marker]</p> <p>Using ▲/▼ button, position the cursor on to the marker number to be called back and press the ENTER button. [Clear the marker]</p> <p>Using ▲/▼ button, position the cursor on to the marker number to be cleared and press the CLEAR button. To clear all markers, place the cursor on “All Clear Markers” and press the ENTER button.</p>
Time Display	The time informations displays on the left side of the screen (Track/All)

## For DVDs

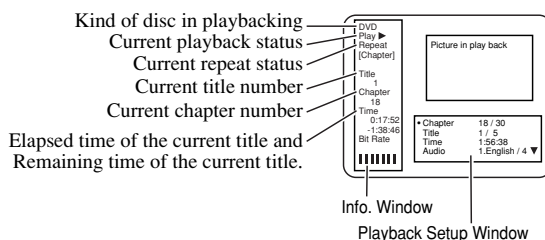

## Playback Setup Window (DVD)

ITEM	DISPLAY CONTENTS
Chapter	Current chapter number / the number of total chapters
Title	Current title number / the number of total titles
Time	Total time of the current title
Audio	Audio No., audio language / the number of available audio languages in the disc
Subtitle	<p>Subtitle No., subtitle language / the number of available subtitle languages in the disc</p> <p>Off : Subtitle is not displays. Not Available : Subtitle is not included.</p>
Angle	<p>Angle No. / total number of the angles 1/1 : Multi angle is not included in the disc.</p> <p>Place the cursor and press the ENTER button to activate the Marker function. [Set the marker]</p> <p>Using ▲/▼ button, position the cursor on to the marker number shown as “Not Set”. Press the ENTER button when the screen to be reviewed appears. Up to 5 points can be marked.</p> <p>[Call back the marker]</p> <p>Using ▲/▼ button, position the cursor on to the marker number to be called back and press the ENTER button. [Clear the marker]</p> <p>Using ▲/▼ button, position the cursor on to the marker number to be cleared and press the CLEAR button. To clear all markers, place the cursor on “All Clear Markers” and press the ENTER button.</p>
SRS TruSurround	The current setting (On/Off) is displayed.

## To exit the display (DVD and CD):

Press the RETURN button.

In the playback Setup Window, press the RETURN button to change the present indication to the former one.

# CHANGING THE SETUP ITEMS

## Note

- When you change the setup items, press the STOP button if you are in playback mode.

## LANGUAGE SETTINGS

### 1 Press the SETUP button.

- The setup screen appears.

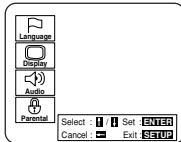

### 2 Press the ▲▼ buttons to select Language, and then press the ENTER button.

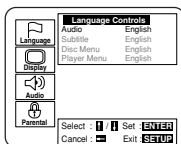

### 3 Press the ▲▼ buttons to select an item, and then press the ENTER button.

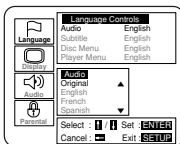

(Voice is played back in selected language.)

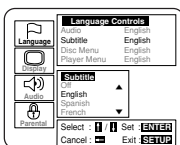

(Subtitles are shown in selected language.)

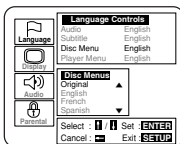

(The disc menu appears in selected language.)

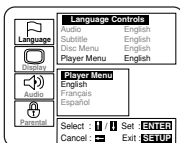

(The on-screen display appears in selected language.)

### 4 Press the ▲▼ buttons to select a desired item, and then press the ENTER button.

- If Other is selected on the Audio, Subtitle or Disc Menu setting screen, the Language Code setting screen will appear. Press the numeric buttons to enter the desired language code while referring to the list on page 25.

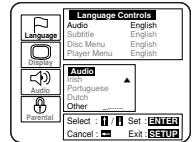

### 5 Press the SETUP button.

- The setup mode will be canceled and the ordinary screen will appear.

## Note

- Language Setting for Audio and Subtitle is not available with some discs. Then use the Audio and Subtitle button. Details are on pages 18 and 19.

# DISPLAY SETTINGS

## 1 Press the SETUP button.

- The setup screen will appear.

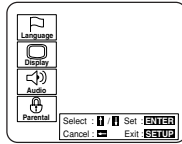

## 2 Press the ▲/▼ buttons to select Display and then press the ENTER button.

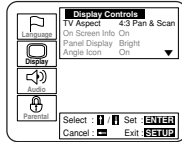

## 3 Press the ▲/▼ buttons to select an item, and then press the ENTER button.

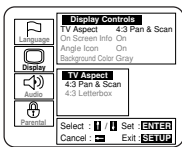

**TV Aspect**  
 (Default : 4:3 Pan & Scan)  
 4:3 Pan & Scan : Full height picture,  
 trimmed both sides  
 4:3 Letter Box : Wide screen with  
 black bars on top and bottom

### Notes

- Some discs do not contain pan and scan images.
- Some discs do not contain letter box images.

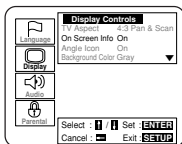

**On Screen Info (Default : On)**  
 Display or not display the disc status  
 (Example "PLAY▶").

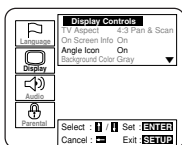

**Angle Icon (Default : On)**  
 Display or not display the Angle icon  
 on the screen.

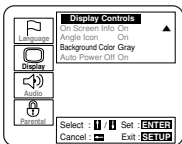

**Background Color (Default : Gray)**  
 Select gray or blue

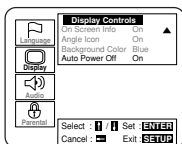

**Auto Power Off (Default : On)**  
 Set or not set to turn off after the  
 screen saver is started and no keys are  
 pressed for 30 minutes..

## 4 Press the ▲/▼ buttons to select a desired item, and then press the ENTER button.

## 5 Press the SETUP button.

- The setup mode will be canceled and the ordinary screen will appear.

# AUDIO SETTINGS

## 1 Press the SETUP button.

- The setup screen will appear.

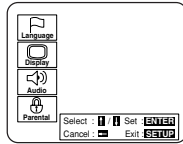

## 2 Press the ▲▼ buttons to select Audio and then press the ENTER button.

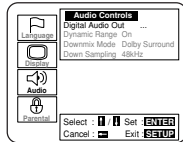

## 3 Press the ▲▼ buttons to select an item, and then press the ENTER button.

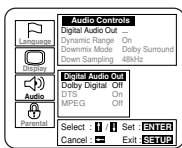

Digital audio out setting (Next step)

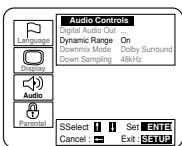

Dynamic Range (Default : Off)  
On : Dynamic range is available

- This function is for controlling the range of sound volume. By compressing the range of sound volume, it is possible not only to suppress the output of loud sound at night and but also to raise the volume of low sound.
- However, this function is effective only for the sound recorded by Dolby Digital recording. When the sound recorded by Dolby Digital 5.1ch is outputted, the sound is compressed automatically even with this function being set at "Off".

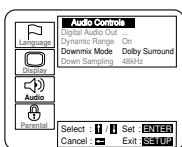

Downmix Mode  
(Default : Dolby Surround)  
Dolby Surround: When the player is connected to an audio component that conforms to Dolby Surround Pro Logic  
STEREO: When the player is connected to a normal audio component

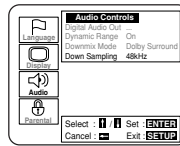

Down Sampling (Default : 48kHz)

Set the output for the DVD recorded in PCM 96kHz (96kHz or 48kHz)

## 4 Press the ▲▼ buttons to select a desired item, and then press the ENTER button.

- If PCM, Dolby Digital or DTS MPEG is selected on the Digital Audio Out setting screen, press the ▲▼ buttons again to select a further item, and then press the ENTER button.

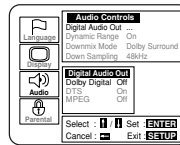

Dolby Digital (Default : Off)  
On : Output by Dolby Digital.  
Set to On when the unit is connected to Dolby Digital Decoder.

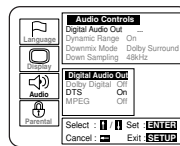

DTS (Default : Off)  
On : Output DTS sound  
Set to On when the unit is connected to DTS Decoder.

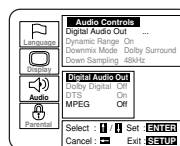

MPEG (Default : Off)  
On : Output by MPEG  
Off : Convert the MPEG to PCM  
Set to On when the unit is connected to MPEG2 Decoder.

## 5 Press the SETUP button.

- The setup mode will be canceled and the ordinary screen will appear.

# PARENTAL LOCK

## 1 Press the SETUP button.

- The setup screen will appear.

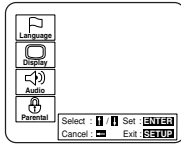

## 2 Press the ▲▼ buttons to select Parental, and then press the ENTER button.

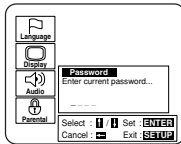

## 3 Press the numeric buttons to enter the 4-digit password, and then press the ENTER button.

- When doing this for the first time, enter any 4 digits. That number will be used as the password from the second time onward.
- By entering the password, you can then change the control level and password settings.

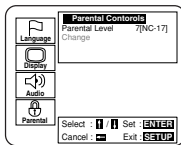

## 4 Press the ▲▼ buttons to select an item, and then press the ENTER button.

### When Parental Level is selected

- Press the ▲▼ buttons to select an item from 8 to 1 and then press the ENTER button.
- When Change is selected, press the numeric buttons to enter the four digits password. Then press the ENTER button.

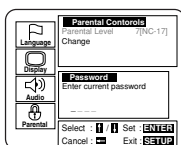
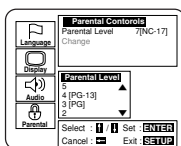

## 5 Press the RETURN button.

- The setup screen will appear.

## CONTROL LEVELS

- **Level 8**  
DVD software of any grade (adult/general/children) can be played back.
- **Levels 7 to 2**  
Only DVD software intended for general use and children can be played back.
- **Level 1**  
Only DVD software intended for children can be played back, with those intended for adult and general use prohibited.

### Notes

- With some DVDs, it may be difficult to find if they are compatible with parental lock. Be sure to check if the parental lock function operates in the way that you have set.
- Record the password in case you forget it.

## IF YOU FORGET THE PASSWORD

- 1) Open the tray.
- 2) Press the 1, 2, 3, 4, then DISPLAY button on the remote control. the default setup screen will appear. Then, press the ENTER button.
- 3) Disconnect the power once and reconnect, then proceed the step 1 to 4 of the PARENTAL LOCK again.

**Note:** If you proceed the above steps, ALL the settings of the DVD player will be cleared. To use the DVD player under the previous settings, set each setting item all over again.



# LANGUAGE CODE LIST

## DVD

No.	Language	Country code	No.	Language	Country code
1	Afar	4747	69	Latvian;Lettish	5868
2	Abkhazian	4748	70	Malagasy	5953
3	Afrikaans	4752	71	Maori	5955
4	Amharic	4759	72	Macedonian	5957
5	Arabic	4764	73	Malayalam	5958
6	Assamese	4765	74	Mongolian	5960
7	Aymara	4771	75	Moldavian	5961
8	Azerbaijani	4772	76	Marathi	5964
9	Bashkir	4847	77	Malay	5965
10	Byelorussian	4851	78	Maltese	5966
11	Bulgarian	4853	79	Burmese	5971
12	Bihari	4854	80	Nauru	6047
13	Bislama	4855	81	Nepali	6051
14	Bengali;Bangla	4860	82	Dutch (DUT)	6058
15	Tibetan	4861	83	Norwegian	6061
16	Breton	4864	84	Occitan	6149
17	Catalan	4947	85	(Afan)Oromo	6159
18	Corsican	4961	86	Oriya	6164
19	Czech	4965	87	Panjabi	6247
20	Welsh	4971	88	Polish	6258
21	Danish	5047	89	Pashto;Pushto	6265
22	German (GER)	5051	90	Portuguese	6266
23	Bhutani	5072	91	Quechua	6367
24	Greek	5158	92	Rhaeto-Romance	6459
25	English (ENG)	5160	93	Kirundi	6460
26	Esperanto	5161	94	Romanian	6461
27	Spanish (SPA)	5165	95	Russian	6467
28	Estonian	5166	96	Kinyarwanda	6469
29	Basque	5167	97	Sanskrit	6547
30	Persian	5247	98	Sindhi	6550
31	Finnish	5255	99	Sangho	6553
32	Fiji	5256	100	Serbo-Croatian	6554
33	Faroese	5261	101	Singhalese	6555
34	French (FRE)	5264	102	Slovak	6557
35	Frisian	5271	103	Slovenian	6558
36	Irish	5347	104	Samoa	6559
37	Scots Gaelic	5350	105	Shona	6560
38	Galician	5358	106	Somali	6561
39	Guarani	5360	107	Albanian	6563
40	Gujarati	5367	108	Serbian	6564
41	Hausa	5447	109	Siswat	6565
42	Hindi	5455	110	Sesotho	6566
43	Croatian	5464	111	Sundanese	6567
44	Hungarian	5467	112	Swedish	6568
45	Armenian	5471	113	Swahili	6569
46	Interlingua	5547	114	Tamil	6647
47	Interlingue	5551	115	Telugu	6652
48	Inupiak	5557	116	Tajik	6653
49	Indonesian	5560	117	Thai	6654
50	Icelandic	5565	118	Tigrinya	6655
51	Italian (ITA)	5566	119	Turkmen	6657
52	Hebrew	5569	120	Tagalog	6658
53	Japanese (JPN)	5647	121	Setswana	6660
54	Yiddish	5655	122	Tonga	6661
55	Javanese	5669	123	Turkish	6664
56	Georgian	5747	124	Tsonga	6665
57	Kazakh	5757	125	Tatar	6666
58	Greenlandic	5758	126	Twi	6669
59	Cambodian	5759	127	Ukrainian	6757
60	Kannada	5760	128	Urdu	6764
61	Korean (KOR)	5761	129	Uzbek	6772
62	Kashmiri	5765	130	Vietnamese	6855
63	Kurdish	5767	131	Volapuk	6861
64	Kirghiz	5771	132	Wolof	6961
65	Latin	5847	133	Xhosa	7054
66	Lingala	5860	134	Yoruba	7161
67	Laothian	5861	135	Chinese (CHI)	7254
68	Lithuanian	5866	136	Zulu	7267

# TROUBLESHOOTING GUIDE

## TV

Sometimes a performance problem can be easily solved by checking seemingly apparent but often overlooked possibilities. Before arranging for service, check these items. It could save your time and money.

Problem	Corrective Action
Remote Control Doesn't Work	<ul style="list-style-type: none"> <li>• Is TV/DVD plugged in?</li> <li>• Power at outlet?</li> <li>• Check batteries in Remote Control.</li> </ul>
Bars On Screen	<ul style="list-style-type: none"> <li>• If outside antenna is being used, check for broken wire.</li> <li>• Check for local interference.</li> </ul>
Picture Distorted or Blurred	<ul style="list-style-type: none"> <li>• Try a new channel, if OK, then possible station trouble.</li> <li>• If outside antenna is being used, check for broken wire.</li> </ul>
Picture Rolls Vertically Lines or Streaks in Picture	<ul style="list-style-type: none"> <li>• Try a new channel, if OK, then possible station trouble.</li> <li>• If outside antenna is being used, check for broken wire.</li> <li>• Check for local interference.</li> </ul>
No Color	<ul style="list-style-type: none"> <li>• Try a new channel, if OK, then possible station trouble.</li> <li>• Is antenna connected to terminal on the back of the set?</li> <li>• If outside antenna is being used, check for broken wire.</li> <li>• Adjust COLOR control.</li> </ul>
Poor Reception on Some Channels Ghosts in Picture	<ul style="list-style-type: none"> <li>• Try a new channel, if OK, then possible station trouble.</li> <li>• Is antenna connected to terminal on the back of the set?</li> <li>• If outside antenna is being used, check for broken wire.</li> <li>• Check for local interference.</li> </ul>
Weak Picture	<ul style="list-style-type: none"> <li>• Try a new channel, if OK, then possible station trouble.</li> <li>• Is antenna connected to terminal on the back of the set?</li> <li>• If outside antenna is being used, check for broken wire.</li> <li>• Adjust CONTRAST &amp; BRIGHT control.</li> </ul>
Sound OK, Picture Poor	<ul style="list-style-type: none"> <li>• Try a new channel, if OK, then possible station trouble.</li> <li>• Is antenna connected to terminal on the back of the set?</li> <li>• If outside antenna is being used, check for broken wire.</li> <li>• Check for local interference.</li> <li>• Adjust CONTRAST &amp; BRIGHT control.</li> </ul>
Picture OK, Sound Poor	<ul style="list-style-type: none"> <li>• Try a new channel, if OK, then possible station trouble.</li> <li>• Check for local interference.</li> </ul>
No Picture or Sound	<ul style="list-style-type: none"> <li>• Try a new channel, if OK, then possible station trouble.</li> <li>• Is TV/DVD plugged in?</li> <li>• Power at outlet?</li> <li>• Is TV/DVD'S POWER button on?</li> <li>• Is antenna connected to terminal on the back of the set?</li> <li>• If outside antenna is being used, check for broken wire.</li> <li>• Turn off with POWER button and then turn it on after about a minute.</li> </ul>

<b>Closed Caption Problem</b>	<b>Possible Remedy</b>
My TV is showing captions that are misspelled.	<ul style="list-style-type: none"> <li>You are watching a live broadcast and spelling errors made by the closed captioning production company may pass through uncorrected. A prerecorded program will not show any misspelled words because of the normal time available for editing the captions.</li> </ul>
My TV will not show the text in its entirety or there is a delay of what is being said.	<ul style="list-style-type: none"> <li>Captions that are delayed a few seconds behind the actual dialogue are common for live broadcast. Most captioning production companies can display a dialogue to a maximum of 220 words per minute. If a dialogue exceeds that rate, selective editing is used to insure that the captions remain up-to-date with the current TV screen dialogue.</li> </ul>
My captions are scrambled with white boxes on the TV screen.	<ul style="list-style-type: none"> <li>Interference caused by building, power lines, thunderstorms, etc. may cause scrambled or incomplete captions to appear.</li> </ul>
My program guide listed a TV show as being closed captioned but none of the captions were displayed.	<ul style="list-style-type: none"> <li>Broadcasters may at times use a time compression process to the actual program so that additional advertising time can be given. Since the decoder cannot read the compressed information, captions will be lost.</li> </ul>
My TV screen shows a black box on certain channels.	<ul style="list-style-type: none"> <li>You are in the TEXT mode. Select CAPTION mode or CAPTION [OFF].</li> </ul>
Uneven color	<ul style="list-style-type: none"> <li>Unplug the AC cord for about 30 minutes, then plug it again.</li> </ul>

**DVD**

If the TV/DVD does not perform properly when operated as instructed in this Owner's Manual, check the player, consulting the following checklist.

<b>Symptom</b>	<b>Cause</b>	<b>Remedy</b>
No power.	<ul style="list-style-type: none"> <li>• Loose power plug.</li> </ul>	<ul style="list-style-type: none"> <li>• Insert the power plug firmly into the wall outlet.</li> </ul>
The player does not respond to the remote control.	<ul style="list-style-type: none"> <li>• The remote control is not aimed at the sensor on the TV/DVD.</li> <li>• Obstacles present between the remote control and the sensor.</li> <li>• The remote control is too far away from the TV/DVD.</li> <li>• Dead batteries.</li> </ul>	<ul style="list-style-type: none"> <li>• Aim the remote control directly at the sensor on the TV/DVD.</li> <li>• Remove the obstacles from the signal path.</li> <li>• Use the remote control within 7m of the TV/DVD.</li> <li>• Replace the batteries.</li> </ul>
No picture	<ul style="list-style-type: none"> <li>• Loose video connection.</li> <li>• Wrong disc.</li> </ul>	<ul style="list-style-type: none"> <li>• Connect the video cables firmly.</li> <li>• Insert a correct video disc that plays on this TV/DVD.</li> </ul>
Disc cannot be played	<ul style="list-style-type: none"> <li>• No disc.</li> <li>• Dirty disc.</li> <li>• Disc is placed upside down.</li> <li>• Parental lock is active.</li> </ul>	<ul style="list-style-type: none"> <li>• Insert a disc.</li> <li>• Clean the disc.</li> <li>• Place the disc correctly, with the label side up.</li> <li>• Cancel the parental lock or change the control level.</li> </ul>
No sound	<ul style="list-style-type: none"> <li>• Loose audio connection.</li> <li>• The power of the connected audio component is off.</li> <li>• Wrong audio output settings.</li> <li>• Wrong input settings on the connected audio component.</li> </ul>	<ul style="list-style-type: none"> <li>• Connect the audio cables firmly.</li> <li>• Turn the power of the audio component on.</li> <li>• Correct the audio output settings.</li> <li>• Correct the input settings on the audio component.</li> </ul>
Distorted picture	<ul style="list-style-type: none"> <li>• Immediately after playing, press fast forward or in reverse.</li> </ul>	<ul style="list-style-type: none"> <li>• There are some cases where pictures may be slightly distorted, which are not a sign of a malfunction.</li> </ul>
Audio or subtitle language does not match the setup.	<ul style="list-style-type: none"> <li>• The selected language is not available for audio or subtitles on the DVD.</li> </ul>	<ul style="list-style-type: none"> <li>• No malfunction.</li> </ul>
The camera angle cannot be changed.	<ul style="list-style-type: none"> <li>• The DVD does not contain sequences recorded from different camera angles.</li> </ul>	<ul style="list-style-type: none"> <li>• No malfunction.</li> </ul>
Audio or subtitle language cannot be changed.	<ul style="list-style-type: none"> <li>• The DVD does not contain audio source or subtitles in the selected language.</li> </ul>	<ul style="list-style-type: none"> <li>• No malfunction.</li> </ul>
"Prohibited icon" appears on the screen, prohibiting an operation.	<ul style="list-style-type: none"> <li>• That operation is prohibited by the TV/DVD or disc.</li> </ul>	<ul style="list-style-type: none"> <li>• No malfunction.</li> </ul>
CD sound dropout No CD reproduction DVD picture dropout DVD picture freeze DVD picture in mosaic No DVD reproduction	<ul style="list-style-type: none"> <li>• Scratched disc</li> </ul>	<ul style="list-style-type: none"> <li>• Replace the disc with unscratched one.</li> </ul>

**NOTES:**

- Some functions are not available in specific modes, but this is not a malfunction. Read the description in this Owner's Manual for details on correct operations.
- Playback from a desired track and random playback are not available during program playback.

# MAINTENANCE

## CABINET CLEANING

- Wipe the front panel and other exterior surfaces of the TV/DVD with a soft cloth immersed in luke-warm water and wrung dry.
- Never use a solvent or alcohol. Do not spray insecticide liquid near the TV/DVD. Such chemicals may cause damage and discoloration to the exposed surfaces.

## SERVICING

- Should your TV/DVD become inoperative, do not try to correct the problem by yourself. There are no user-serviceable parts inside. Turn off, unplug the power cord, and please call our help line at 1-800-968-3429, to locate an Authorized Service Center.

## IF THE LASER OPTICAL PICKUP UNIT IS DIRTY

- If the player still does not perform properly when it is operated while referring to the relevant sections and to "TROUBLESHOOTING GUIDE" in this Owner's Manual, the laser optical pickup unit may be dirty. Consult your dealer or an Authorized Service Center for inspection and cleaning of the laser optical pickup unit.

## DISC HANDLING

- Use discs which have the following logos on them. (Optical audio digital discs.)



- Handle the discs so that fingerprints and dust do not adhere to the surfaces of the discs.

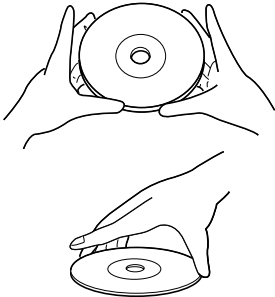

- Always store the disc in its protective case when it is not used.

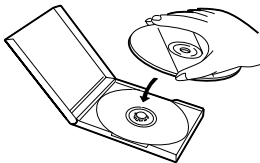

- To clean-off, use a soft cloth.
- Do not use a hard cloth since this will mar the disc.
- Wipe the disc in a straight line from center to edge.
- Never wipe with a circular motion.
- Do not use detergent or abrasive cleaning agents.

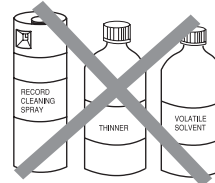
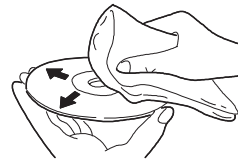

# SPECIFICATIONS

## GENERAL SPECIFICATIONS

### TV

Television system:	NTSC-M TV Standard
Closed caption system:	§15.119/FCC
Channel coverage:	
VHF:	2 ~ 13
UHF:	14 ~ 69
CATV:	2 ~ 13, A ~ W, W+1 ~ W+84, A-5 ~ A-1, 5A
Tuning System:	181 channel frequency synthesized tuning system
Channel access:	Direct access keyboard, programmable scan and up/down

### DVD

Product type:	DVD Player
Discs:	DVD video, Audio CD
Output signal format:	NTSC color
Frequency response (output jack)	
DVD (linear sound):	20 Hz to 22 kHz (sample rate: 48 kHz) 20 Hz to 44 kHz (sample rate: 96 kHz)
CD:	20 Hz to 20 kHz
Signal-to-noise ratio (S/N ratio)(output jack)	
CD:	100 dB (EIAJ)
Dynamic range (output jack)	
DVD (linear sound):	85 dB
CD:	84 dB (EIAJ)
Total distortion factor	
CD:	0.07% (EIAJ)
Wow and flutter:	Below the measurement limitation (+/-0.001% W PEAK) (EIAJ)

## ELECTRICAL SPECIFICATIONS

Sound output: 2 speakers, 1W, 8 ohm

## OTHER SPECIFICATIONS

Terminals	
Antenna input:	VHF/UHF/CATV 75 ohm unbalanced (F-type)
Video input:	RCA connector × 1
Audio L/R input:	RCA connector × 2
Headphone:	1/8" stereo (3.5 mm)
Coaxial digital audio output (only DVD):	One pin jack, 500m Vpp (75 ohm)
Analog audio L/R output (only DVD):	RCA connector × 2
Remote control:	Digital encoded infrared light system
Operating temperature:	5°C to 40°C (41°F~104°F)
Power requirements:	AC 120V, 60Hz
Power consumption (Maximum):	90W
Picture tube:	19"
Dimensions:	H:19-5/8" (498mm) W:19-3/8" (492mm) D:18-21/32" (474mm)
Weight:	41.9 lbs (19kg)
Accessories:	Remote Control Unit with 2"AA"batteries Owner's Manual

- Designs and specifications are subject to change without notice and without our legal obligation.
- If there is a discrepancy between languages, the default language will be English.

# INDICE

■ <b>CONTROLES DE OPERACIÓN Y FUNCIONES</b> . . . . .	39
PANEL FRONTAL DEL TELEVISOR/DVD . . . . .	39
MANDO A DISTANCIA . . . . .	39
VISTA POSTERIOR . . . . .	39
■ <b>PREPARACIÓN PARA LA UTILIZACIÓN</b> . . . . .	40
CONEXIONES DE ANTENA/TELEVISIÓN	
POR CABLE . . . . .	40
INSTALACIÓN DE LAS PILAS . . . . .	41
CONEXIÓN A TOMAS DE ENTRADA EXTERNA . . . . .	41
CONEXIÓN A UN SISTEMA ESTÉREO (Para DVD) . . . . .	41
CONEXIÓN A UN AMPLIFICADOR EQUIPADO CON	
TOMAS DE ENTRADA DIGITAL, PLATINA MD O	
PLATINA DAT (Para DVD) . . . . .	41
CONEXIÓN A UN DECODIFICADOR DOLBY DIGITAL	
O A UN DECODIFICADOR DTS (Para DVD) . . . . .	41

## TV SECTION

■ <b>PREPARACIÓN PARA LA UTILIZACIÓN</b> . . . . .	42
SELECCIÓN DE IDIOMA . . . . .	42
PREAJUSTE DE CANALES . . . . .	42

## DVD SECTION

■ <b>REPRODUCCIÓN DE UN DISCO</b> . . . . .	43
REPRODUCCIÓN DE UN DVD DE VÍDEO O UN CD DE	
AUDIO . . . . .	43

# CONTROLES DE OPERACIÓN Y FUNCIONES

## PANEL FRONTAL DEL TELEVISOR/DVD

Consulte la figura 1 de la página 8

## MANDO A DISTANCIA

Consulte la figura 2 de la página 8

## VISTA POSTERIOR

Consulte la figura 3 de la página 9

### 1. Bandeja de carga del disco

### 2. Toma de entrada VIDEO

Conecte aquí la toma de salida de vídeo de una videocámara o de una videograbadora.

### 3. Tomas de entrada AUDIO L/R

Conecte aquí las tomas de salida de audio de una videocámara o de una videograbadora.

### 4. Botón POWER

Púlselo para conectar y desconectar la alimentación.

### 5. Botones VOLUME ▲/▼

Púlselos para controlar el nivel del volumen para el DVD y el televisor.

### 6. Botones CHANNEL ▲/▼

Púlselo para seleccionar el canal memorizado.  
Púlselo para cambiar a un modo de televisor cuando modo de DVD.

### 7. Ventanilla del sensor del mando a distancia

### 8. Botón STOP

Detiene la operación del disco.

### 9. Botón REV

Reproduce rápidamente hacia atrás hasta un punto deseado.

### 10. Botón PLAY

Inicia la reproducción del contenido del disco.  
Púlselo para cambiar a un modo de DVD cuando modo de televisor.

### 11. Botón FWD

Reproduce rápidamente hacia adelante hasta un punto deseado.

### 12. Botón PAUSE

Hace una pausa en la operación del disco.

### 13. Botón OPEN/CLOSE

Púlselo para insertar discos en la bandeja o retirarlos de ella.

### 14. Toma HEADPHONE

Para conectar auriculares (no suministrados) y escuchar en privado.

### 15. Botón MODE

Activa el modo de reproducción programada o el modo de reproducción aleatoria.

### 16. Botones de números

#### Modo del televisor:

Pulse dos dígitos para tener acceso directamente al canal deseado.

Recuerde pulsar "0" antes de elegir un canal de un solo dígito.

#### Botón +100

Púlselo para seleccionar canales de televisión por cable cuyo número sea igual o superior al 100.

#### Modo DVD:

Púlselo para introducir el número deseado.

#### Botón +10

Púlselo para introducir los números deseados cuyo número sea igual o superior al 10.

### 17. Botón SLEEP

Pulse el botón SLEEP para visualizar el temporizador para dormir y activar la función. La hora de apagado puede determinarse por el número de veces que usted pulsa el botón. (0, 10, 20, 30, 90, 0 minutos)

### 18. Botones SKIP

Salta capítulos o pistas hasta un punto deseado.

### 19. Botón ZOOM

Activa el modo de reproducción programada o el modo de reproducción aleatoria.

### 20. Botón SETUP

Púlselo para activar o salir del modo de menús de televisor o preparación de DVD.

### 21. Botón TITLE

Visualiza el menú de títulos.

### 22. Botón CLEAR

Repone un ajuste.

### 23. Botón DISPLAY

**Modo del televisor:**

Púlselo para visualizar el número del canal en la pantalla. Si lo pulsa de nuevo, el número del canal desaparecerá.

**Modo de DVD:**

Visualiza el estado actual en la pantalla del televisor con fines de comprobación.

**24. Botón SEARCH MODE**

Púlselo para localizar un punto deseado.

**25. Botón AUDIO**

Púlselo para seleccionar un idioma de audio o un modo de sonido deseado.

**26. Botón SUBTITLE**

Púlselo para seleccionar un idioma de subtítulos deseado.

**27. Botón REPEAT**

Repita la reproducción del disco, título, capítulo o pista actual.

**28. Botón ANGLE**

Púlselo para cambiar el ángulo de la cámara y verde, desde un ángulo diferente, la secuencia que está siendo reproducida.

**29. Botón A-B REPEAT**

Repita la reproducción de una sección seleccionada.

**30. Botón RETURN**

Para volver a la operación anterior.

**31. Botón ENTER**

Púlselo para establecer un ajuste.

**32. Botones de flechas****Modo de televisor:**

Púlselo para seleccionar un modo de ajuste desde el menú que aparece en la pantalla del televisor. Púlselo para seleccionar o ajustar desde un menú particular.

**Modo de DVD:**

Se utiliza cuando se hacen ajustes mientras se observa la visualización en una pantalla de televisor.

**33. Botón DISC MENU**

Visualiza menús en el DVD.

**34. Botón SELECT**

Púlselo para cambiar a un modo de televisor, modo de entrada externa o modo de DVD.

**35. Botón MUTE**

Pulse el botón MUTE para apagar el sonido de un programa de TV. La visualización del nivel del sonido cambia de ROJO CLARO a AZUL CLARO.) Pulse de nuevo el botón MUTE o el botón VOL  $\triangle$  o  $\nabla$  para restaurar el sonido.

**36. Botón PICTURE**

Presione para entrar en el modo de ajuste de imagen.

**37. Cable de alimentación**

Conéctelo a una toma de CA convencional (120 V/60 Hz).

**NOTA:** Retire el cable de alimentación del gancho para evitar romperlo antes de conectarlo a una toma de CA convencional.

**38. Toma de salida de audio digital COAXIAL**

Conéctela a la entrada digital de un amplificador o decodificador externo.

**39. Toma de salida AUDIO L/R**

Conéctela a la entrada de audio analógico de un amplificador o decodificador externo.

**NOTA:** Las tomas de entrada de audio (roja y blanca) en el lado trasero sirven para producir no el son televisor ni el son de entrada externa, sino el son DVD.

**40. Toma de entrada ANT.**

Conéctela a una antena, sistema de televisión por cable o sistema de satélite.

## PREPARACIÓN PARA LA UTILIZACIÓN

### CONEXIONES DE ANTENA/TELEVISIÓN POR CABLE

**ANTENA COMBINADA DE VHF/UHF**

La antena de varilla de VHF/UHF (no suministrada) es desmontable. Inserte el vástago de la antena en el agujero de la parte superior del televisor/DVD. Conecte la antena de varilla de VHF/UHF o la antena combinada de VHF/UHF al terminal ANT. del televisor/DVD como se muestra en el diagrama de abajo. Para obtener la mejor recepción, extienda completamente la antena de varilla de VHF/UHF y haga los ajustes necesarios. (Evite tocar la sección superior cuando haga el ajuste.)

**NOTA:**

Antes de enchufar la antena de varilla en un terminal de antena, compruebe que la clavija no esté doblada. Si lo está, enderece la clavija como se muestra en la ilustración y luego enchufe la clavija en el terminal de antena.

**Consulte la figura 4 de la página 10**

**NOTA:**

La conexión de una antena interior puede que no proporcione siempre una recepción de TV aceptable.

**ANTENAS SEPARADAS DE VHF/UHF**

En algunas áreas será necesario utilizar una antena exterior.

**Consulte la figura 5 de la página 10**



## TELEVISIÓN POR CABLE SIN CAJA DE CONVERTIDOR/DECODIFICADOR

Utilice esta conexión si su sistema de televisión por cable se conecta directamente a su televisor/DVD sin necesidad de caja de convertidor.

Consulte la figura 6 de la página 11

## TELEVISIÓN POR CABLE CON CAJA DE CONVERTIDOR/DECODIFICADOR O CAJA DE SATÉLITE

Si su proveedor de servicios de televisión por cable le suministra una caja de convertidor o si usted utiliza un sistema de satélite, podrá utilizar la conexión básica mostrada aquí.

Consulte la figura 7 de la página 11

## INSTALACIÓN DE LAS PILAS

- 1) Abra la tapa del compartimiento de las pilas del mando a distancia presionándola en el sentido de la flecha.
- 2) Inserte 2 pilas tamaño "AA" en su compartimiento colocando las polaridades (+/-) en sus posiciones correspondientes.
- 3) Vuelva a poner la tapa.

## CONEXIÓN A TOMAS DE ENTRADA EXTERNA

Cuando vea un programa grabado en otra fuente (videograbadora o videocámara), utilice las tomas de entrada de audio/vídeo de la parte delantera del televisor/DVD.

Conecte las tomas de salida de audio/vídeo de otra fuente a las tomas AUDIO L/R y VIDEO de este televisor/DVD. Y luego pulse el botón SELECT hasta que "VIDEO" aparezca en la pantalla.

### NOTA:

- Cuando conecte una videograbadora monoaural (otra fuente) a este televisor/DVD, conecte la toma de salida de audio de la videograbadora monoaural (otra fuente) a la toma AUDIO L de este televisor/DVD. El audio saldrá igualmente en los canales L y R.

Consulte la figura 8 de la página 12

Conexiones de antena/televisión por cable  
Continúa en la página siguiente.

## CONEXIÓN A UN SISTEMA ESTÉREO (Para DVD)

Consulte la figura 9 de la página 13

### NOTAS:

- Asegúrese de desconectar la alimentación a todos los componentes del sistema antes de hacer la conexión a otro componente.
- Consulte el manual del propietario de su sistema estéreo y de cualquier otro componente que vaya a conectar al televisor/DVD.
- Las tomas de entrada de audio (roja y blanca) en el lado trasero sirven para producir no el son televisor ni el son de entrada externa, sino el son DVD.

## CONEXIÓN A UN AMPLIFICADOR EQUIPADO CON TOMAS DE ENTRADA DIGITAL, PLATINA MD O PLATINA DAT (Para DVD)

Utilice un cable digital coaxial (de venta en el comercio) para las conexiones de audio.

Consulte la figura 10 de la página 13

### NOTAS:

- La fuente de audio de un disco del formato de sonido ambiental Dolby Digital de 5,1 canales no puede ser grabada como sonido digital por una platina MD o DAT.
- Asegúrese de desconectar la alimentación de todos los componentes del sistema antes de hacer la conexión a otro componente.
- Consulte los manuales del propietario de los componentes que vaya a conectar al televisor/DVD.
- Ponga DOLBY DIGITAL y DTS en OFF para la salida de audio en el modo de preparación. La reproducción en el televisor/DVD utilizando los ajustes incorrectos puede generar distorsión de ruido, y también puede estropear los altavoces.
- El audio se silenciará cuando DOLBY DIGITAL se ponga en OFF y VIRTUAL 3D se ponga en ON para la salida de audio en el modo de preparación y usted seleccione la fuente de audio del formato de sonido ambiental Dolby Digital de 5,1 canales.

## CONEXIÓN A UN DECODIFICADOR DOLBY DIGITAL O A UN DECODIFICADOR DTS (Para DVD)

Si se utiliza este televisor/DVD para reproducir fuentes del formato de sonido ambiental Dolby Digital de 5,1 canales o de sonido ambiental DTS, el televisor/DVD dará salida a un flujo de datos Dolby Digital o DTS desde su toma de salida de audio digital COAXIAL. Conectando el reproductor a un decodificador Dolby Digital o DTS, usted podrá disfrutar de un ambiente más convincente y real con un sonido ambiental potente y de alta calidad de tipo profesional tal como el que se oye en salas de cine. Utilice cables digitales coaxiales (de venta en el comercio) para las conexiones de audio.

Consulte la figura 11 de la página 14

### NOTAS:

- Asegúrese de desconectar la alimentación de todos los componentes del sistema antes de hacer la conexión a otro componente.
- Consulte los manuales del propietario de los componentes que vaya a conectar al televisor/DVD.
- Si conecta un decodificador Dolby Digital, ponga DOLBY DIGITAL en ON para la salida de audio en el modo de preparación.
- Si conecta un decodificador DTS, ponga DTS en ON para la salida de audio en el modo de preparación.
- A menos que se haga la conexión a un decodificador Dolby Digital o DTS, ponga DOLBY DIGITAL y DTS en OFF para la salida de audio en el modo de preparación. La reproducción en el televisor/DVD utilizando los ajustes incorrectos puede generar distorsión de ruido, y también puede estropear los altavoces.
- El audio se silenciará cuando DOLBY DIGITAL se ponga en OFF y VIRTUAL 3D se ponga en ON para la salida de audio en el modo de preparación y usted seleccione la fuente de audio del formato de sonido ambiental Dolby Digital de 5,1 canales.

Fabricado bajo licencia de Dolby Laboratories. "Dolby" y el símbolo de la D doble son marcas de fábrica de Dolby Laboratories.

"DTS" y "DTS Digital Out" son marcas de fábrica de Digital Theater Systems, Inc.

## TV SECTION

### PREPARACIÓN PARA LA UTILIZACIÓN

#### Para empezar

1

Conecte el cable de alimentación a una toma de CA convencional.

**NOTA:** Si aparecen algunos dígitos en la esquina de la pantalla, pulse el botón POWER sin desenchufar el cable de alimentación.

2

Pulse el botón POWER para encender el televisor/DVD.

3

Pulse el botón SELECT del mando a distancia hasta que el número del canal o "TV" aparezca en la pantalla. Luego pulse el botón TV.

### SELECCIÓN DE IDIOMA

Si desea cambiar el idioma del menú en pantalla, siga el procedimiento de abajo.

1

Pulse el botón MENU para que la visualización del menú aparezca en la pantalla del televisor.

2

Pulse el botón de flecha ▲ o ▼ para apuntar a "LENGUAJE".

3

Seleccione "ENGLISH" (inglés), "ESPAÑOL" o "FRANÇAIS" (francés) utilizando el botón de flecha ► o ◀.

4

Pulse el botón MENU para salir del menú.

**NOTA:** Para el modo del televisor y el modo del DVD se deberá seleccionar un idioma de visualización en pantalla.

### PREAJUSTE DE CANALES

Para preajustar un canal o cambiar un canal de preajuste, siga el procedimiento de abajo.

## DVD SECTION

# REPRODUCCIÓN DE UN DISCO

## REPRODUCCIÓN DE UN DVD DE VÍDEO O UN CD DE AUDIO

DVD

CD

1

Pulse el botón MENU para que la visualización del menú aparezca en la pantalla del televisor.

2

Pulse el botón de flecha ▲ o ▼ para apuntar a "CANALES PROGRAMADOS". Luego pulse el botón de flecha ►.

3

Pulse el botón de flecha ▲ o ▼ para apuntar a "MEMO AUTOMÁTICA". Luego pulse el botón de flecha ►.

El sintonizador explora y memoriza todos los canales activos de su zona.

- El televisor distingue entre los canales de TV convencional y los canales de televisión por cable.
- Cuando termine la función AUTO MEMO, el canal memorizado más bajo vuelve a aparecer en la pantalla.
- Cuando pulse el botón de flecha ▲ o ▼ después de seleccionar AUTO MEMO, el sintonizador se detendrá en los canales sin memorizar solamente.
- El televisor puede considerar canales de TV como canales CATV según las condiciones de la recepción. En este caso, active de nuevo la función AUTO MEMO en condiciones de recepción fina.

### [FUNCIÓN DE ADICIÓN/BORRADO]

- 1) Pulse el botón MENU para que la visualización del menú aparezca en la pantalla del televisor.
- 2) Pulse el botón de flecha ▲ o ▼ para apuntar a "CANALES PROGRAMADOS". Luego pulse el botón de flecha ►.
- 3) Pulse el botón de flecha ▲ o ▼ para apuntar a "AÑADIR/BORRAR". Luego pulse el botón de flecha ►.
- 4) Utilice el botón de flecha ▲ o ▼ para seleccionar el canal que desee memorizar o borrar de la memoria.

**NOTA:** La visualización volverá a la pantalla en unos 10 segundos. Realice la función "AÑADIR/BORRAR" mientras aparece la visualización en la pantalla.

- Pulse el botón de flecha ► o ◀ para encender el número de canal en AZUL CLARO si usted desea añadir el canal a la memoria.
- Pulse el botón de flecha ► o ◀ para encender el número de canal en ROJO CLARO si usted desea borrar el canal a la memoria.

- 5) Pulse el botón MENU para salir del menú.

### Para empezar

Conecte la alimentación del televisor, amplificador y cualquier otro componente que esté conectado al reproductor DVD. (Cambie el sistema de entrada para adaptarlo al reproductor DVD, y compruebe que el volumen del sonido sea correcto.)

#### 1 Pulse el botón POWER.

- La alimentación se conectará.

#### 2 Pulse el botón OPEN/CLOSE.

- La bandeja de carga del disco se abrirá.

#### 3 Ponga un disco en la bandeja.

- Asegúrese de que el disco esté correctamente asentado en el hueco correcto, con el lado de la etiqueta hacia arriba.

#### 4 Pulse el botón PLAY.

- La bandeja se cerrará automáticamente y la reproducción empezará desde el primer capítulo o pista del disco. Necesitará pulsar el botón PLAY sólo cuando la bandeja haya sido cerrada pulsando el botón OPEN/CLOSE.
- Cuando reproduzca un DVD que tenga grabado un menú de títulos, el menú tal vez aparezca en la pantalla. En este caso, consulte "UTILIZACIÓN DEL MENÚ DE TÍTULOS".

#### 5 Pulse el botón STOP para detener la reproducción.

# Get it fixed, at your home or ours!

For repair of major brand appliances **in your own home...**  
no matter who made it, no matter who sold it!

**1-800-4-MY-HOME** <sup>SM</sup> Anytime, day or night  
(1-800-469-4663)

[www.sears.com](http://www.sears.com)

To bring in products such as vacuums,  
lawn equipment and electronics for repair, call for  
the location of your nearest **Sears Parts & Repair Center.**

**1-800-488-1222** Anytime, day or night  
[www.sears.com](http://www.sears.com)

For the replacement parts, accessories and owner's manuals  
that you need to do-it-yourself, call **Sears PartsDirect** <sup>SM</sup>!

**1-800-366-PART** 6 a.m. – 11 p.m. CST,  
(1-800-366-7278) 7 days a week

[www.sears.com/partsdirect](http://www.sears.com/partsdirect)

To purchase or inquire about a Sears Service Agreement:

**1-800-827-6655**  
7 a.m. – 5 p.m. CST, Mon. – Sat.

Para pedir servicio de reparación a domicilio,  
y para ordenar piezas con entrega a domicilio:

**1-888-SU-HOGAR** <sup>SM</sup>  
(1-888-784-6427)

Au Canada pour service en français:

**1-877-LE-FOYER** <sup>SM</sup>  
(1-877-533-6937)



© Sears, Roebuck and Co.

® Registered Trademark / <sup>TM</sup> Trademark of Sears, Roebuck and Co.  
® Marca Registrada / <sup>TM</sup> Marca de Fábrica de Sears, Roebuck and Co.

## FULL 90 DAY WARRANTY

For 90 days from the date of purchase, Sears will repair any defect in material or workmanship in this TV/DVD, free of charge. For one year from the date of purchase, SEARS will supply, at no charge, replacement for defective parts.

Two (2) years for Picture Tube. Certain parts are excluded from this warranty.

The above warranty coverage applies only to TV/DVD which are used for private household purposes.

TO OBTAIN WARRANTY SERVICE, SIMPLY RETURN THE TV/DVD TO THE NEAREST SEARS SERVICE CENTER IN THE UNITED STATES.

This warranty gives you specific legal rights, and you may also have other rights which vary from state to state.

**Sears Roebuck and Co., Dept. 817WA Hoffman Estates, IL 60179**  
**For the location of a Sears Service Center in your area : 1-800-488-1222**

Printed in Malaysia

Download from [Www.Somanuals.com](http://Www.Somanuals.com). All Manuals Search And Download.

OEMN01971  
TD253UD ★★★★★

## Free Manuals Download Website

<http://myh66.com>

<http://usermanuals.us>

<http://www.somanuals.com>

<http://www.4manuals.cc>

<http://www.manual-lib.com>

<http://www.404manual.com>

<http://www.luxmanual.com>

<http://aubethermostatmanual.com>

Golf course search by state

<http://golfingnear.com>

Email search by domain

<http://emailbydomain.com>

Auto manuals search

<http://auto.somanuals.com>

TV manuals search

<http://tv.somanuals.com>