

# OWNER'S MANUAL

# SYLVANIA

## 9-INCH COLOR TV/VCR 6309CB

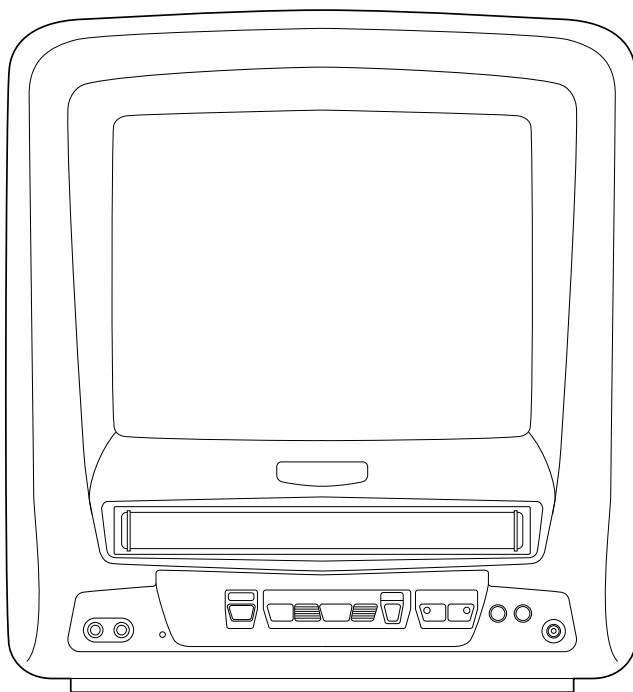

**This Owner's Manual is made of  
recycled paper.**

**INSTRUCCIONES EN ESPAÑOL INCLUIDAS.**

 As an ENERGY STAR® Partner, our company has determined that this product meets the ENERGY STAR® guidelines for energy efficiency. ENERGY STAR® is a U.S. registered mark.

If you need additional assistance for set-up or operating after reading owner's manual, please call  
**TOLL FREE : 1-800-968-3429.**

**VHS**

**WARNING:** TO REDUCE THE RISK OF FIRE OR ELECTRIC SHOCK, DO NOT EXPOSE THIS APPLIANCE TO RAIN OR MOISTURE.



**CAUTION**  
**RISK OF ELECTRIC SHOCK**  
**DO NOT OPEN**



**CAUTION:** TO REDUCE THE RISK OF ELECTRIC SHOCK, DO NOT REMOVE COVER (OR BACK). NO USER SERVICEABLE PARTS INSIDE. REFER SERVICING TO QUALIFIED SERVICE PERSONNEL.



THIS SYMBOL INDICATES THAT DANGEROUS VOLTAGE CONSTITUTING A RISK OF ELECTRIC SHOCK IS PRESENT WITHIN THIS UNIT.



THIS SYMBOL INDICATES THAT THERE ARE IMPORTANT OPERATING AND MAINTENANCE INSTRUCTIONS IN THE LITERATURE ACCOMPANYING THE APPLIANCE.

The caution marking is located on the rear of the cabinet.

## IMPORTANT SAFEGUARDS

**1. Read instructions-**All the safety and operating instructions should be read before the appliance is operated.

**2. Retain Instructions-**The safety and operating instructions should be retained for future reference.

**3. Heed Warnings-**All warnings on the appliance and in the operating instructions should be adhered to.

**4. Follow Instructions-**All operating and use instructions should be followed.

**5. Cleaning-**Unplug TV/VCR from the wall outlet before cleaning. Do not use liquid cleaners or aerosol cleaners. Use a damp cloth for cleaning.

**EXCEPTION:** A product that is meant for uninterrupted service and, that for some specific reason, such as the possibility of the loss of an authorization code for a CATV converter, is not intended to be unplugged by the user for cleaning or any other purpose, may exclude the reference to unplugging the appliance in the cleaning description otherwise required in item 5.

**6. Attachments-**Do not use attachments not recommended by the TV/VCR manufacturer as they may cause hazards.

**7. Water and Moisture-**Do not use this TV/VCR near water—for example, near a bath tub, wash bowl, kitchen sink, or laundry tub, in a wet basement, or near a swimming pool, and the like.

**8. Accessories-**Do not place this TV/VCR on an unstable cart, stand, tripod, bracket, or table. The TV/VCR may fall, causing serious injury to someone, and serious damage to the appliance. Use only with a cart, stand, tripod, bracket, or table recommended by the manufacturer, or sold with the TV/VCR. Any mounting of the appliance should follow the manufacturer's instructions and should use a mounting accessory recommended by the manufacturer. An appliance and cart combination should be moved with care.

PORTABLE CART WARNING



S3126A

Quick stops, excessive force, and uneven surfaces may cause the appliance and cart combination to overturn.

**9. Ventilation-**Slots and openings in the cabinet and the back or bottom are provided for ventilation and to ensure reliable operation of the TV/VCR and to protect it from overheating, and these openings must not be blocked or covered. The openings should never be blocked by placing the TV/VCR on a bed, sofa, rug, or other similar surface. This TV/VCR should never be placed near or over a radiator or heat register. This TV/VCR should not be placed in a built-in installation such as a bookcase or rack unless proper ventilation is provided or the manufacturer's instructions have been adhered to.

**10. Power Sources-**This TV/VCR should be operated only from the type of power source indicated on the marking label. If you are not sure of the type of power supply to your home, consult your appliance dealer or local power company. For TV/VCRs intended to operate from battery power, or other sources, refer to the operating instructions.

**11. Grounding or Polarization-**This TV/VCR is equipped with a polarized alternating-current line plug (a plug having one blade wider than the other). This plug will fit into the power outlet only one way. This is a safety feature. If you are unable to insert the plug fully into the outlet, try reversing the plug. If the plug should still fail to fit, contact your electrician to replace your obsolete outlet. Do not defeat the safety purpose of the polarized plug.

**12. Power-Cord Protection-**Power-supply cords should be routed so that they are not likely to be walked on or pinched by items placed upon or against them, paying particular attention to cords at plugs, convenience receptacles, and the point where they exit from the appliance.

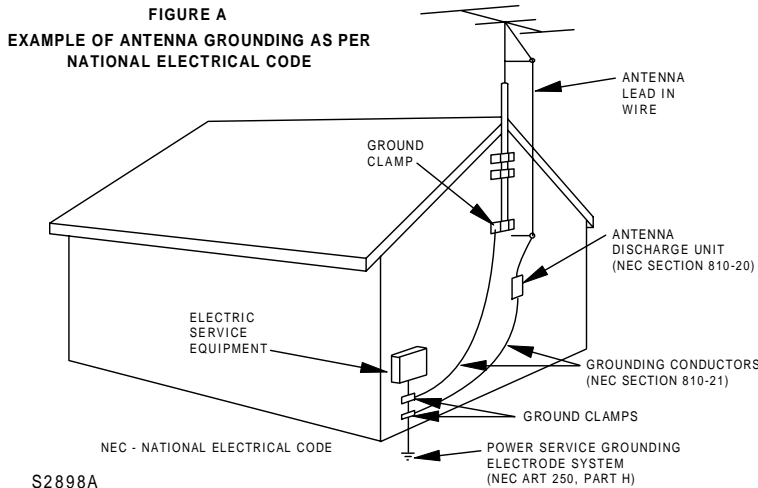

**13. Outdoor Antenna grounding-**If an outside antenna or cable system is connected to the TV/VCR, be sure the antenna or cable system is grounded so as to provide some protection against voltage surges and built-up static charges. Article 810 of the National Electrical Code, ANSI/NFPA No. 70, provides information with respect to proper grounding of the mast and supporting structure, grounding of the lead-in wire to an antenna discharge unit, size of grounding conductors, location of antenna-discharge unit, connection to grounding electrodes, and requirements for the grounding electrode. (Fig. A)

**14. Lightning-**For added protection for this TV/VCR receiver during a lightning storm, or when it is left unattended and unused for long periods of time, unplug it from the wall outlet and disconnect the antenna or cable system. This will prevent damage to the TV/VCR due to lightning and power-line surges.

**15. Power Lines-**An outside antenna system should not be located in the vicinity of overhead power lines or other electric light or power circuits, or where it can fall into such power lines or circuits. When installing an outside antenna system, extreme care should be taken to keep from touching such power lines or circuits as contact with them might be fatal.

**16. Overloading-**Do not overload wall outlets and extension cords as this can result in a risk of fire or electric shock.

**17. Object and Liquid Entry-**Never push objects of any kind into this TV/VCR through openings as they may touch dangerous voltage points or short out parts that could result in a fire or electric shock. Never spill liquid of any kind on the TV/VCR.

**18. Servicing-**Do not attempt to service this TV/VCR yourself as opening or removing covers may expose you to dangerous voltage or other hazards. Refer all servicing to qualified service personnel.

**19. Damage Requiring Service-**Unplug this TV/VCR from the wall outlet and refer servicing to qualified service personnel under the following conditions:

- a. When the power-supply cord or plug is damaged or frayed.
- b. If liquid has been spilled, or objects have fallen into the TV/VCR.
- c. If the TV/VCR has been exposed to rain or water.
- d. If the TV/VCR does not operate normally by following the operating instructions. Adjust only those controls that are covered by the operating instructions, as improper adjustment of other controls may result in damage and will often require extensive work by a qualified technician to restore the TV/VCR to its normal operation.
- e. If the TV/VCR has been dropped or damaged in any way.
- f. When the TV/VCR exhibits a distinct change in performance-this indicates a need for service.

**20. Replacement Parts-**When replacement parts are required, be sure the service technician has used replacement parts specified by the manufacturer that have the same characteristics as the original part. Unauthorized substitutions may result in fire, electric shock, injury to persons or other hazards.

**21. Safety Check-**Upon completion of any service or repairs to this TV/VCR, ask the service technician to perform routine safety checks to determine that the TV/VCR is in proper operating condition.

**22. Heat-**This TV/VCR product should be situated away from heat sources such as radiators, heat registers, stoves, or other products (including amplifiers) that produce heat.

# PRECAUTIONS

## LOCATION

For safe operation and satisfactory performance of your TV/VCR, keep the following in mind when selecting a place for its installation:

- Shield it from direct sunlight and keep it away from sources of intense heat.
- Avoid dusty or humid places.
- Avoid places with insufficient ventilation for proper heat dissipation. Do not block the ventilation holes at the top and bottom of the unit. Do not place the unit on a carpet because this will block the ventilation holes.
- Install unit in a horizontal position.
- Avoid locations subject to strong vibration.
- Do not place the TV/VCR near strong magnetic fields.
- Avoid moving TV/VCR to locations where temperature differences are extreme.

## AVOID THE HAZARDS OF ELECTRICAL SHOCK AND FIRE

- Do not handle the power cord with wet hands.
- Do not pull on the power cord when disconnecting it from an AC wall outlet. Grasp it by the plug.
- If, by accident, water is spilled on your unit, unplug the power cord immediately and take the unit to our Authorized Service Center for servicing.
- Do not put your fingers or objects into the TV/VCR cassette holder.
- Do not place anything directly on top of the unit.

## WARNING

Moisture condensation may occur inside the unit when it is moved from a cold place to a warm place, or after heating a cold room or under conditions of high humidity. If a tape is played in a TV/VCR which has moisture, it may damage the tape and TV/VCR. Therefore when the condensation occurs inside the unit, "DEW" appears on the screen. In this case, turn the POWER button on and allow at least 2 hours for the unit to dry out.

The serial number of this product may be found on the back of the unit. No other TV/VCR has the same serial number as yours. You should record the number and other vital information here and retain this book as a permanent record of your purchase to aid identification in case of theft. Serial numbers are not kept on file.

Date of Purchase	
Dealer Purchase from	
Dealer Address	
Dealer Phone No.	
Model No.	
Serial No.	

## IMPORTANT COPYRIGHT INFORMATION

Unauthorized recording or use of broadcast television programming, video tape, film or other copyrighted material may violate applicable copyright laws. We assume no responsibility for the unauthorized duplication, use, or other acts which infringe upon the rights of copyright owners.

**FCC WARNING- This equipment may generate or use radio frequency energy. Changes or modifications to this equipment may cause harmful interference unless the modifications are expressly approved in the instruction manual. The user could lose the authority to operate this equipment if an unauthorized change or modification is made.**

This equipment has been tested and found to comply with the limits for a Class B digital device, pursuant to Part 15 of the FCC Rules. These limits are designed to provide reasonable protection against harmful interference in a residential installation. This equipment generates, uses, and can radiate radio frequency energy and, if not installed and used in accordance with the instructions, may cause harmful interference to radio communications. However, there is no guarantee that interference will not occur in a particular installation. If this equipment does cause harmful interference to radio or television reception, which can be determined by turning the equipment off and on, the user is encouraged to try to correct the interference by one or more of the following measures:

- 1) Reorient or relocate the receiving antenna.
- 2) Increase the separation between the equipment and receiver.
- 3) Connect the equipment into an outlet on a circuit different from that to which the receiver is connected.
- 4) Consult the dealer or an experienced radio/TV technician for help.

# TABLE OF CONTENTS

<ul style="list-style-type: none"> <li>■ <b>IMPORTANT SAFEGUARDS</b> .....2</li> <li>■ <b>PRECAUTIONS</b> .....4</li> <li>■ <b>FEATURES</b> .....6</li> <li>■ <b>SUPPLIED ACCESSORIES</b> .....6</li> <li>■ <b>OPERATING CONTROLS AND FUNCTIONS</b> 7</li> <li>■ <b>PREPARATION FOR USE</b> .....9</li> <li>■ <b>SET UP FOR USE</b> .....11 <ul style="list-style-type: none"> <li>CHANNEL SET UP FOR THE FIRST TIME .11</li> <li>CLOCK SET UP (AUTO / MANUAL) .....12</li> <li>CHANNEL SET UP AGAIN .....13</li> <li>DELETING (OR ADDING) CHANNEL .....13</li> <li>SELECTING THE LANGUAGE .....14</li> <li>DAYLIGHT-SAVING TIME .....14</li> </ul> </li> <li>■ <b>TV OPERATION</b> .....15 <ul style="list-style-type: none"> <li>WATCHING A TV PROGRAM .....15</li> <li>GAME MODE .....15</li> <li>DEGAUSSING .....15</li> <li>PICTURE CONTROL .....15</li> </ul> </li> <li>■ <b>PLAYBACK</b> .....16 <ul style="list-style-type: none"> <li>NORMAL PLAYBACK .....16</li> <li>AUTO REPEAT PLAYBACK .....16</li> <li>SEARCH .....17</li> <li>STILL PICTURE .....17</li> <li>NOISE CANCEL (in the Still mode) .....18</li> <li>VERTICAL HOLD CONTROL .....18</li> <li>TRACKING ADJUSTMENT .....18</li> <li>RENTAL PLAYBACK .....18</li> </ul> </li> </ul>	<ul style="list-style-type: none"> <li>■ <b>RECORDING</b> .....18 <ul style="list-style-type: none"> <li>NORMAL RECORDING .....19</li> <li>SKIPPING UNWANTED SCENES DURING RECORDING .....19</li> <li>OTR (One Touch Recording) .....19</li> <li>TIMER RECORDING .....20</li> <li>TIMER PROGRAM EXTENSION .....31</li> <li>HINTS FOR AUTOMATIC TIMER RECORDING .....22</li> <li>AUTO RETURN .....22</li> <li>WAKE UP TIMER .....22</li> <li>SLEEP TIMER .....23</li> </ul> </li> <li>■ <b>COPYING A VIDEO TAPE</b> .....23</li> <li>■ <b>ON SCREEN DISPLAY</b> .....24</li> <li>■ <b>SPECIAL FEATURES</b> .....24 <ul style="list-style-type: none"> <li>REAL TIME TAPE COUNTER .....24</li> <li>AUTO REWIND-EJECT .....24</li> </ul> </li> <li>■ <b>MAINTENANCE</b> .....24</li> <li>■ <b>TROUBLESHOOTING GUIDE</b> .....25</li> <li>■ <b>SPECIFICATIONS</b> .....26</li> <li>■ <b>CABLE CHANNEL DESIGNATIONS</b> .....26</li> <li>■ <b>WARRANTY</b> .....Back Cover</li> </ul>
---	--

## INDICE

<ul style="list-style-type: none"> <li><b>CONTROLES DE OPERACIÓN Y SUS FUNCIONES</b> .....27</li> <li><b>CONEXIONES DE ANTENA/CABLE</b> .....29</li> <li><b>INSTALACIÓN DE LAS PILAS</b> .....30</li> </ul>	<ul style="list-style-type: none"> <li><b>MODO DE ENTRADA EXTERNA</b> .....30</li> <li><b>PREPARACIÓN DE CANALES POR PRIMERA VEZ</b> .....31</li> <li><b>AJUSTE DEL RELOJ</b> .....31</li> </ul>
---	--

### **A NOTE ABOUT RECYCLING**



This product's packaging materials are recyclable and can be reused. Please dispose of any materials in accordance with your local recycling regulations.

Batteries should never be thrown away or incinerated but disposed of in accordance with your local regulations concerning chemical wastes.

# FEATURES

- **Infrared remote control**
- **Dew Sensor**—Indicates that moisture condensation may occur inside the TV/VCR.
- **Bilingual on screen menu display selectable in English or Spanish**
- **Real time counter**—This shows the elapsed recording or playback time in hours, minutes, and seconds. The “\_” indication will appear when the tape is rewound further than the tape counter position “0:00:00”.
- **181 channel capability PLL frequency synthesizer tuner with direct station call**—(A converter may be necessary to view scrambled cable channels.)
- **Auto Clock Setting**—Allows you to set the clock function from a PBS broadcast station.
- **Game mode**—Automatically sets external input mode and allows TV/VCR display to be suitable for use with TV games.
- **Auto power on and off system**—Automatically turns on the TV/VCR when you insert the cassette, turns off after auto-rewind, and ejects when the beginning of the tape is reached.
- **Auto rewind when the end of a tape is reached**—This function doesn’t occur when using timer recording.
- **2 Step picture search operation**—You can view a video program at a high speed or super high speed in either a forward or reverse direction in LP and SLP mode. For SP mode only high speed.
- **Three different playback tape speeds : SP/LP/SLP**
- **Two different recording tape speeds : SP/SLP**
- **Auto Head Cleaner**—Automatically cleans video heads as you insert or remove a cassette.
- **Zero Return**—The tape returns to counter of 0:00:00 by rewinding or fast forwarding.
- **Still**—“Freeze” the picture at any time, for close viewing of a particular scene. Only tapes recorded in SLP mode will show a fairly clear picture.
- **Digital Auto Tracking (DTR)**—Automatically adjusts the tracking for each tape you play.
- **Rental play mode**—Improves playback picture quality from worn tapes, such as rental tapes.
- **Auto repeat**—Allows you to repeat the playing of a tape indefinitely without pressing the PLAY button.
- **Time search**—Let you set the TV/VCR to advance the tape by entering the desired playback time you want to skip.
- **OTR (One Touch Recording)**—Instant timed recording from 30 to 480 minutes is possible at the push of the REC/OTR button.
- **1 Year, 8 events (including Daily and Weekly Timer Recording)**—The built-in timer allows you to record up to 8 programs at different times on different channels up to 1 year in advance. The Daily timer allows recordings to be made of daily broadcasts, and the Weekly timer allows recording to be made once a week up to the end of the tape.
- **Auto return**—After timer recording is finished, the TV/VCR can return to the beginning of the recording.
- **Wake up/Sleep timer**—Allows you to have the TV/VCR automatically turn on or off at a desired time.
- **Timer Program Extension**—Allow you to shift the time schedule for automatic timer recording.
- **Two-way power**—Allows you to power the TV/VCR with standard household AC or your vehicle’s battery, using the supplied car-battery cord.

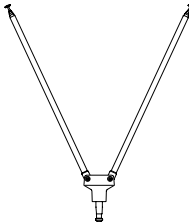
# SUPPLIED ACCESSORIES

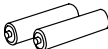
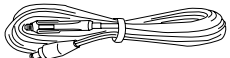
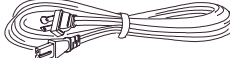
<p>Remote Control Unit</p>  <p>PART NO. (N0111UD)</p>	<p>Dipole Antenna</p>  <p>(0EMN00723 or 0EMN01183)</p>	<p>Matching Adapter (300ohm-75ohm)</p>  <p>(1813641 or 1780258 or UCPGANTPK004)</p> <p>2 AA Batteries</p> 	<p>Car Battery Cord</p>  <p>WPZ0202GA004</p> <hr/> <p>AC Cord</p>  <p>WPV0182LW001</p>
--	---	--	--

- If you need to replace these accessories, please refer to the PART NO. under the illustrations and call 1-800-968-3429.
- Depending on your antenna system, you may need different types of Combiners (Mixer) or Separators (Splitter). Contact your local electronics store for these items.
- We do not recommend the use of universal remote controls. Not all of the functions may be controlled with a universal remote control. If you decide to use a universal remote control with this unit, please be aware that the code number given may not operate this unit. In this case, please call the manufacturer of the universal remote control.

# OPERATING CONTROLS AND FUNCTIONS

## - TV/VCR FRONT PANEL -

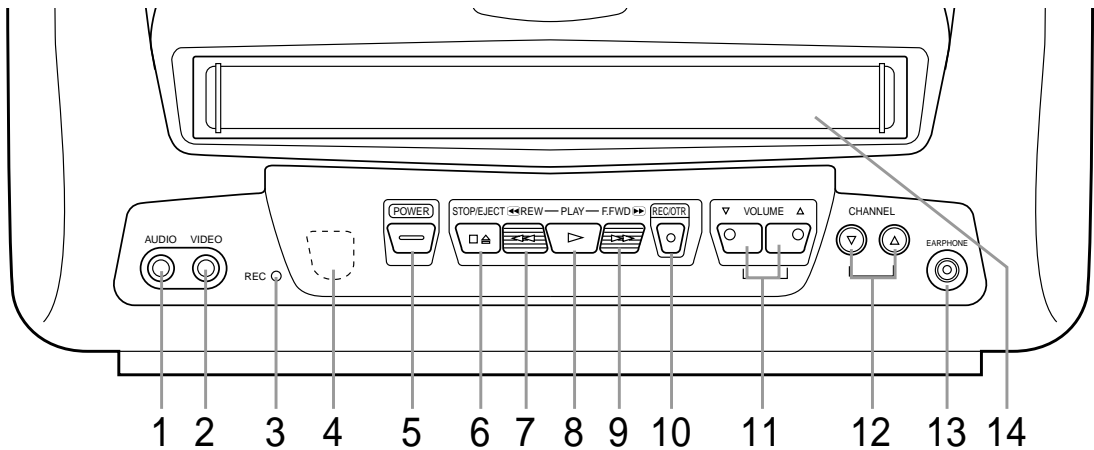

## - REMOTE CONTROL -

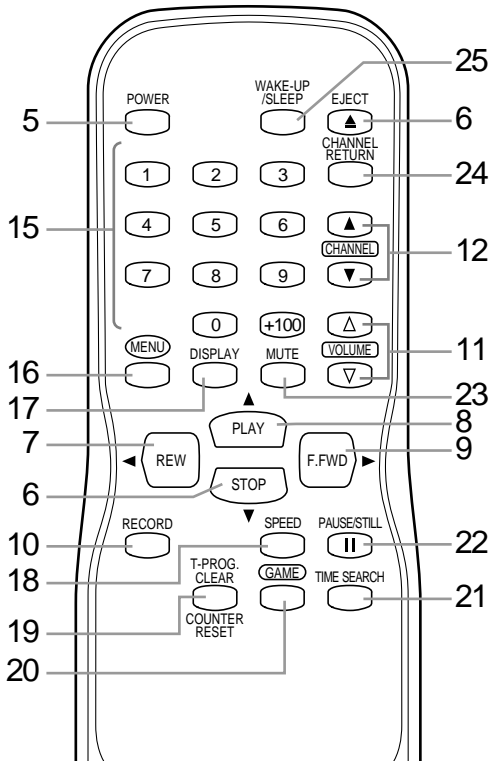

- 1 **AUDIO input jack**– Connect to the audio output jack of your audio equipment, video camera or another VCR.
- 2 **VIDEO input jack**– Connect to the video output jack of your video camera or another VCR.
- 3 **RECORD indicator**– Flashes during recording. Lights up in the Stand-by mode for Timer Recording.
- 4 **Remote Sensor Window**– Receives the infrared signals from the remote control.

- 5 **POWER button**– Press to turn TV/VCR on and off. Press to activate timer recording.
- 6 **STOP button**– Press to stop the tape motion. **EJECT button**– Press in the Stop mode to remove tape from TV/VCR.
  - ▼ **button**–
    - Press to select setting modes from the on screen menu.
    - Press to enter digits when setting program. (for example: setting clock or timer program)
- 7 **REW button**– Press to rewind the tape, or to view the picture rapidly in reverse during playback mode. (Rewind Search)
  - ◀ **button**–
    - Press to select a mode from a particular menu. (for example: LANGUAGE or USER'S SET UP)
- 8 **PLAY button**– Press to begin playback.
  - ▲ **button**–
    - Press to select setting modes from the on screen menu.
    - Press to enter digits when setting program. (for example: setting clock or timer program)
- 9 **F.FWD button**– Press to rapidly advance the tape, or to view the picture rapidly in forward during playback mode. (Forward Search)
  - ▶ **button**–
    - When setting program (for example: setting clock or timer program), press to determine your selection and proceed to the next step you want to input.
    - Press to determine setting modes from on screen menu.
    - Press to select a mode from a particular menu. (for example: LANGUAGE or USER'S SET UP)

- REAR VIEW -

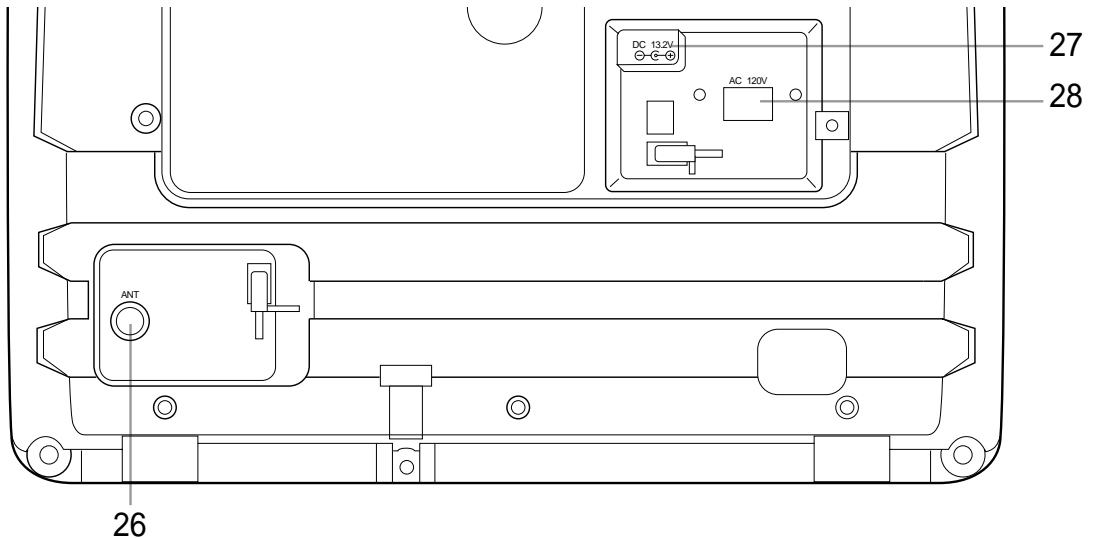

- 10 REC button**– Press for manual recording.
- OTR button**– Activates One Touch Recording. (only on the TV/VCR)
- 11 VOLUME  $\Delta$  /  $\nabla$  buttons**– Adjust the volume level.
- 12 CHANNEL  $\blacktriangle$  /  $\blacktriangledown$  buttons**– Press to select the desired channels for viewing or recording. You may display the main menu on the TV screen by pressing repeatedly this button on the TV/VCR.
- TRACKING function**– Press to minimize video ‘noise’ (lines or dots on screen) during playback mode. (See page 18.)
- 13 EARPHONE jack**– Connects to earphones (not supplied) for personal listening. The size of jack is 1/8” monaural (3.5mm).
- 14 Cassette compartment**
- 15 Number buttons**– Press to select desired channels for viewing or recording. To select channels from 1 to 9, first press the 0 button and then 1 to 9.
- +100 button**– When selecting cable channels which are higher than 99, press this button first, then press the last two digits. (To select channel 125, first press the “+100” button then press “2” and “5”.)
- 16 MENU button**– Press to display the main menu on the TV screen.
- 17 DISPLAY button**– Display the counter or the current channel number and current time on the TV screen. (See page 24.)
- 18 SPEED button**– Press to choose the desired recording speed:SP/SLP.
- 19 T-PROG. CLEAR button**– Press to cancel a setting of timer program. (See page 22.)
- COUNTER RESET button**– Press to reset counter to 0:00:00.
- 20 GAME button**– Sets the game mode and external input mode at the same time. (See page 15.)
- 21 TIME SEARCH button**– Press to activate Time Search mode.
- 22 PAUSE/STILL button**– Press to temporarily stop the tape during the recording or to view a still picture during playback.
- 23 MUTE button**– Mutes the sound. Press it again to resume sound.
- 24 CHANNEL RETURN button**– Press to go back to the previously viewed channel. For example, pressing this button once will change channel display from 3 (present channel) to 10 (previously viewed channel), and pressing it a second time will return from 10 to 3.
- 25 WAKE-UP/SLEEP button**– Sets the Wake up or Sleep Timer. (See page 22 and 23.)
- 26 ANT. terminal**– Connect to an antenna or cable system.
- 27 DC 13.2V jack**– Connect to the Car Battery Cord.
- 28 AC 120V jack**– Connect to the AC cord.



## PREPARATION FOR USE

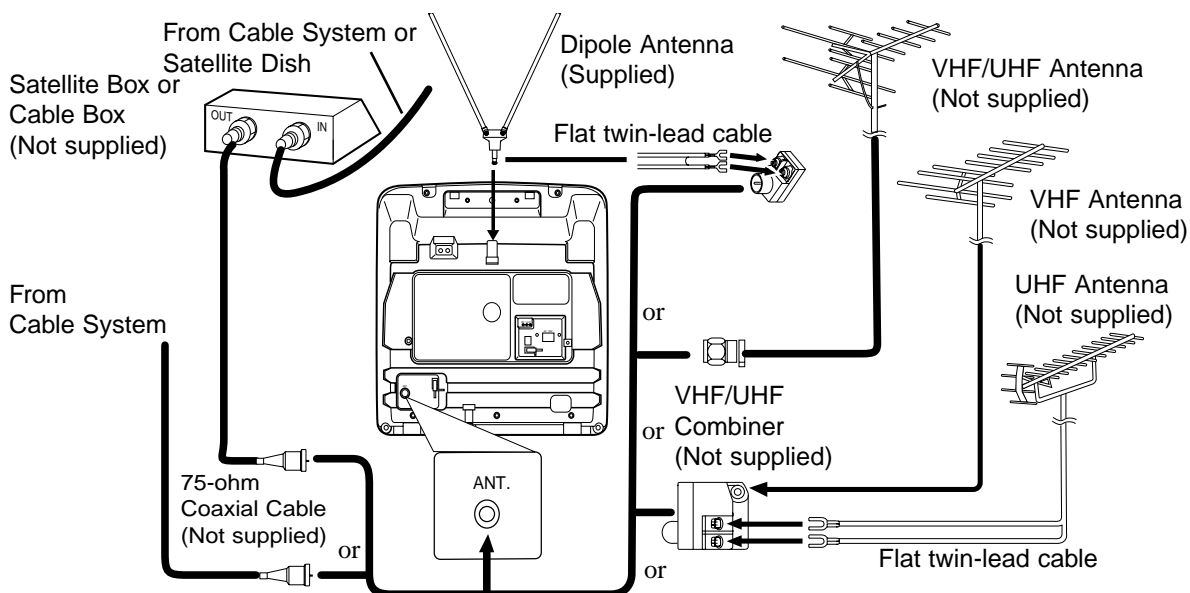

### ANTENNA/CABLE CONNECTIONS

#### VHF/UHF COMBINED ANTENNA

A VHF UHF 75 ohm combination antenna can be connected to ANT terminal.

#### VHF/UHF SEPARATE ANTENNAS

In some areas it will be necessary to use an outdoor antenna.

#### CABLE WITHOUT CONVERTER/DESCRAMBLER BOX

Use this connection if your cable system connects directly to your TV/VCR without a converter box.

By using this connection you can:

- 1) Use the TV/VCR remote to select channels.
- 2) Program one or more unscrambled channels for Automatic Timer Recording.

**NOTE:** This unit will ONLY record and view the same channel.

#### DIPOLE ANTENNA HOOK UP

1. Push the stem of the Dipole Antenna (accessory) into the hole for antenna at the back of TV/VCR.
2. Connect the flat twin-lead cable from the Dipole Antenna to the 300/75 ohm Matching Adapter (accessory).
3. Plug the Matching Adapter to ANT terminal of TV/VCR as shown in drawing.

For the best reception, extend the Dipole Antenna and adjust its length and position. (Avoid handling the top section when making adjustments.)

**NOTE:** If it is difficult to get good reception with the indoor antenna, the use of an outdoor antenna is recommended. Before an outdoor antenna is connected to the set, the indoor antenna should be disconnected.

#### Note to CATV system installer:

This reminder is provided to call the CATV system installer's attention to Article 820-40 of the NEC that provides guidelines for proper grounding and, in particular, specifies that the cable ground shall be connected to the grounding system of the building as close to the point of cable entry as practical.

Antenna/Cable Connections Continued on the Next Page.

## CABLE WITH CONVERTER/ DESCRAMBLER BOX OR SATELLITE BOX

If your cable service supplies you with a converter box or if you use a satellite system, you can use the basic connection shown in drawing.

By using this connection you can also record scrambled channels. However, channel selection must be made with the converter box or satellite box. This means that channels cannot be changed using the TV/VCR Remote Control. Unattended timer recording is limited to one channel at a time.

### TO RECORD A SCRAMBLED/UNSCRAMBLED CHANNEL

1. Set the TV/VCR channel selector to the output channel of the Cable Converter Box or Satellite Box. (Ex. CH3)
2. Select the channel to record from your Cable Converter Box or Satellite Box.

## INSTALLING THE BATTERIES

- 1) Open the battery compartment cover by pressing the cover on the remote unit in the direction of the arrow.
- 2) Insert 2 "AA" penlight batteries into the battery compartment in the direction indicated by the polarity (+/-) markings.
- 3) Replace the cover.

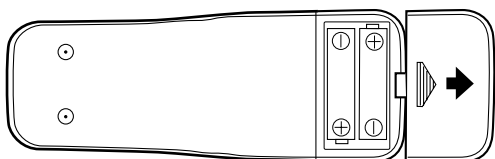

## EXTERNAL INPUT MODE

When using an external input signal (another VCR or video camera), connect the player's audio/video output cables to the AUDIO IN/ VIDEO IN jacks of your TV/VCR. Then press the CHANNEL ▲ or ▼ button until "AUX" appears on the screen.

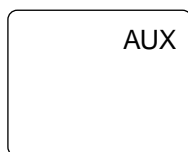

## MOBILE CONNECTION

**WARNING:** The driver should never watch the TV/VCR while operating a motor vehicle.

**CAUTION:** If you use the TV/VCR with the vehicle's engine off, recharge the vehicle's battery after about every 4 hours of use to prevent it from running down. After you finish using the TV/VCR be sure you unplug the car-battery cord from the cigarette-lighter socket.

- 1) The supplied indoor antenna is adequate when your vehicle is stationary. For best reception on the road, use a high-quality VHF/UHF mobile TV antenna.
- 2) Attach the car battery cord to the DC13.2V (12V) connector on the back of the TV/VCR. Then, connect the other end to your vehicle's cigarette-lighter socket.

### NOTES:

- Be sure your vehicle has a 13.2-volt (12-volt), negative-ground electrical system.
- Be sure you use only the supplied car battery cord. Using another cord could damage the TV/VCR.
- Be sure the socket is free of ashes and other debris.
- Be sure to push the car battery cord's plug completely into the cigarette-lighter socket.
- Always unplug the car battery from the cigarette-lighter socket before you unplug it from the TV/VCR.
- You must disconnect the car battery cord from the TV/VCR before you can use the AC power.
- Be sure to replace the fuse with only the same type, 5A, 250V.

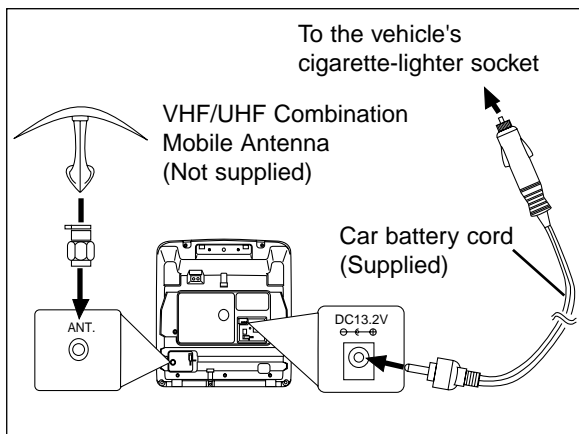

# SET UP FOR USE

You can program the tuner to scan all the channels you receive in your area.

**NOTE:** Channel memory programming is NOT needed when connected to a cable box or satellite box. Just select the TV/VCR channel selector to the output channel of the cable box or satellite box (Ex CH3). Then select the channel to be viewed on the Cable Box or Satellite Box.

## CHANNEL SET UP FOR THE FIRST TIME

### 1 Plug in the TV/VCR power cord

Attach the smaller end of the supplied AC cord to the AC 120V connector on the back of the TV/VCR. Then, plug the other end into a standard AC outlet.

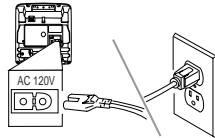

#### NOTES:

- You must disconnect the car battery cord from the TV/VCR before you use AC power.
- If some digits appear in the corner of the screen, press the POWER button without unplugging the power cord.

### 2 Turn on the TV/VCR

Press the POWER button to turn on the TV/VCR.

### 3 Select "ENGLISH" or "ESPAÑOL"

Select "ENGLISH" or "ESPAÑOL"=Spanish using the F.FWD/▶ or REW/◀ button. "[ ]" indicate the selected language.

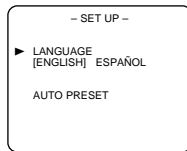

### 4 Begin auto preset

Press the PLAY/▲ or STOP/▼ button to point to "AUTO PRESET". Then press the F.FWD/▶ button. The tuner scans and memorizes all active channels in your area.



#### NOTES:

- The TV/VCR distinguishes between standard TV channels and cable channels.
- If you want to play or record a video tape BEFORE presetting the tuner, you must press the MENU button on the remote control. To preset the tuner again, see "CHANNEL SET UP AGAIN" on page 13.
- The TV/VCR may recognize TV channels to be CATV channels by the receiving conditions. In this case, try auto preset again in the fine receiving conditions.

### 5 After scanning

The tuner stops on the lowest memorized channel. If you want to recall the selected channels, you can select the desired channel directly with the remote control number buttons or CHANNEL ▲ or ▼ button.

## TO SELECT A DESIRED CHANNEL

You can select the desired channel by using the CHANNEL ▲ or ▼ button or directly pressing the number buttons on the remote control.

Note for using the number buttons:

- When selecting cable channels which are higher than 99, press the +100 button first, then, press the last two digits. (Example: to select channel 125, first press the +100 button then press "2" and "5").
- You must proceed single-digit channel numbers with a zero (Example: 02 ... 09).

## CLOCK SET UP (AUTO / MANUAL)

Set the clock accurately for proper automatic timer recording. If the Public Broadcasting Station (PBS) is available in your area, follow "AUTO CLOCK SETTING". If it is not, follow "MANUAL CLOCK SETTING".

### AUTO CLOCK SETTING

You can have the TV/VCR set the clock automatically by using the Public Broadcasting Station (PBS) channel in your area. Once you have set the clock by using the following procedure, the TV/VCR will automatically monitor the correct time and date being broadcast by the PBS station in your area, using a new service called Extended Data Service (XDS).

#### Make sure ...

- TV/VCR power must be turned on.
- Confirm that the antenna connections are correct.
- The cable converter box must be turned on if your TV/VCR is connected directly to it. (See NOTES:)
- The channel is properly set in advance.

## NOTES:

- Auto clock setting only needs to be set once. But it can be done again if the clock's time has become incorrect for some reason.
- If the TV/VCR is connected directly to a cable converter box or satellite box, the local PBS station must be selected on the cable box itself, and the TV/VCR must be set to the output channel of the cable converter box or satellite box (usually channel 3 or 4), to be able to set up or correct the clock automatically.

If you do not know what your local PBS station is, then follow "Manual Clock Settings".

The TV/VCR cannot control the channels of the cable converter box or satellite box.

### 1 Select "SETTING CLOCK"

Press the MENU button on the remote control.

Press the PLAY/▲ or STOP/▼ button to point to "SETTING CLOCK".

Then, press the F.FWD/▶ button.

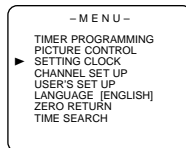

### 2 Set "AUTO CLOCK" to [ON]

Press the F.FWD/▶ or REW/◀ button repeatedly until [ON] appears.

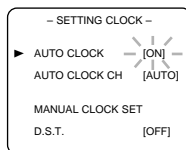

### 3 Enter the channel number for the PBS station

Press the PLAY/▲ or STOP/▼ button to point to "AUTO CLOCK CH".

Then press the F.FWD/▶ or REW/◀ button until the channel number for your local PBS station appears.

If you do not know the PBS channel number, leave it set to [AUTO] which is located before [2]. The TV/VCR will search automatically all available channels for the local PBS station, and will select that channel.

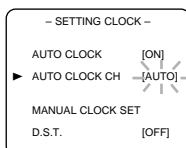

### 4 Exit the Auto Clock Setting

Press the MENU button on the remote control to return to TV mode.

### 5 Turn off the TV/VCR

Turn the TV/VCR off. Because the Auto Clock functions automatically while the TV/VCR is off.

## If you choose [AUTO],

- The TV/VCR must search until the PBS channel is found. It must scan each channel for a couple of seconds to determine if that channel is transmitting the XDS signal.
- If the time, that is automatically set by this selected PBS station is incorrect, it may not be your local PBS station, but one from a different time zone. Or there is a case that no channel is broadcasting the XDS signal in your area, as shown by no time. In these cases, you must manually enter the correct local PBS station, or set the clock manually and turn off the Auto Clock Setting feature.

## MANUAL CLOCK SETTING

### Make sure ...

- TV/VCR power must be turned on.

In the example below, the clock is to be set to:

DATE May 1st, 2001  
SETTING TIME 5:40PM

### 1 Select "SETTING CLOCK"

Press the MENU button on the remote control.

Press the PLAY/▲ or STOP/▼ button to point to "SETTING CLOCK".

Then, press the F.FWD/▶ button.

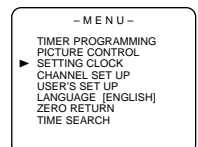

### 2 Select "MANUAL CLOCK SET"

Press the PLAY/▲ or STOP/▼ button to point to "MANUAL CLOCK SET".

Then, press the F.FWD/▶ button.

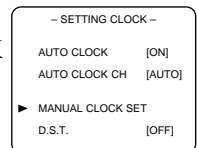

### 3 Select the month

Press the PLAY/▲ or STOP/▼ button until your desired month appears. (Example: May → 05)

Then, press the F.FWD/▶ button.

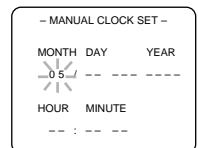

### 4 Select the day

Press the PLAY/▲ or STOP/▼ button until your desired day appears. (Example: 1st → 01)

Then, press the F.FWD/▶ button.

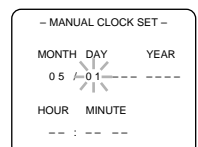

## 5 Select the year

Press the PLAY/▲ or STOP/▼ button until your desired year appears. (Example: 2001)  
Then, press the F.FWD/▶ button.

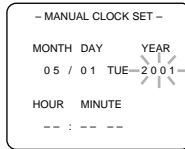

## 6 Select the hour

Press the PLAY/▲ or STOP/▼ button until your desired hour appears. (Example: 5, PM)  
Then, press the F.FWD/▶ button.

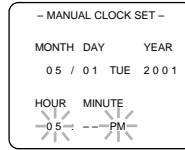

## 7 Select the minute

Press the PLAY/▲ or STOP/▼ button until the desired minute appears. (Example: 40)

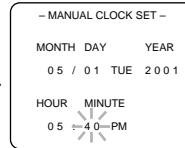

## 8 Start the clock

Press the MENU button on the remote control.

Although seconds are not displayed, they begin counting from 00 when you press the MENU button on the remote control. Use this feature to synchronize the clock with the correct time.

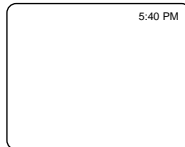

### NOTE:

When unplugging the AC cord or if there is a power failure for more than 30 seconds, you may have to reset the clock.

## TO CHANGE CLOCK SETTING

If you want to change the clock,

- 1) Follow steps [1] and [2].
- 2) Select where you want to change using the F.FWD/▶ or REW/◀ button.
- 3) Enter correct numbers using the PLAY/▲ or STOP/▼ button.
- 4) Press the MENU button on the remote control to start the clock.

### PLEASE NOTE:

If there is no local PBS station in your area or on your cable system, select "AUTO CLOCK" and press the F.FWD/▶ or REW/◀ button to turn [OFF] this function. Then you can manually adjust the clock.

## CHANNEL SET UP AGAIN

### Make sure ...

- Press the POWER button to turn on the TV/VCR.

### 1 Select "CHANNEL SET UP"

Press the MENU button on the remote control.

Press the PLAY/▲ or STOP/▼ button to point to "CHANNEL SET UP".

Then, press the F.FWD/▶ button.

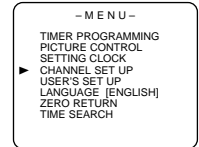

### 2 Begin auto preset

Press the PLAY/▲ or STOP/▼ button to point to "AUTO PRESET".

Then, press the F.FWD/▶ button. The tuner scans and memorizes all the active channels in your area.

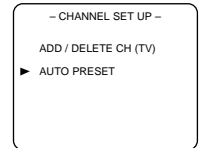

### 3 After scanning

The tuner stops on the lowest memorized channel.

## DELETING (OR ADDING) CHANNEL

The channels you no longer receive or seldom watch can be deleted from the memory. (Of course, you can add the deleted channel into the memory again.)

### 1 Select "CHANNEL SET UP"

Press the MENU button on the remote control. Then press the PLAY/▲ or STOP/▼ button to point to "CHANNEL SET UP".

Then, press the F.FWD/▶ button.

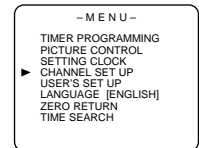

### 2 Select "ADD/DELETE CH"

Press the PLAY/▲ or STOP/▼ button to point to "ADD/DELETE CH".

Press the F.FWD/▶ button.

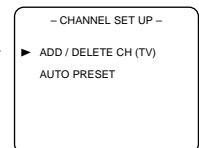

### 3 Enter the desired channel number

Press the PLAY/▲ or STOP/▼ button until your desired channel number appears. (You can also use the number buttons or the CHANNEL ▲/▼ button to enter it.) (Example: CH8)

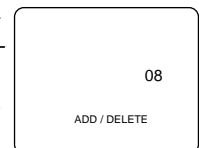

#### 4 Delete (or add) it from (into) memory

Press the F.FWD/▶ or REW/◀ button. The channel number changes to light red. The channel is deleted from memory.

- To delete another channel, repeat steps [3] and [4].
- If you press the F.FWD/▶ or REW/◀ button again, the channel is memorized again.

**Added channel: Light blue.**  
**Deleted channel: Light red.**

#### 5 Exit the channel setup mode

Press the MENU button on the remote control to return to TV mode.

**NOTE:** To confirm that channel(s) has been deleted or added, press the CHANNEL ▲ or ▼ button.

## SELECTING THE LANGUAGE

**Make sure ...**

- Press the POWER button to turn on the TV/VCR.

**NOTE:** This function effects only the language on the screen menu and not the audio source.

#### 1 Select "LANGUAGE"

Press the MENU button on the remote control.

Press the PLAY/▲ or STOP/▼ button to point to "LANGUAGE".

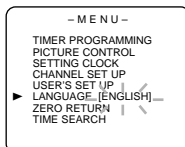

#### 2 Select "ENGLISH" or "ESPAÑOL"

Select "ENGLISH" or "ESPAÑOL" = Spanish using the F.FWD/▶ or REW/◀ button.

#### 3 Exit the Language mode

Press the MENU button on the remote control to return to TV mode.

**NOTE:** If for some reason the menu is in Spanish, press the MENU button on the remote control, press the PLAY/▲ button to point to "IDIOMA [ESPAÑOL]", then press the F.FWD/▶ button, then press the MENU button on the remote control.

## DAYLIGHT-SAVING TIME

Select this feature and the TV/VCR's clock automatically will advance one hour in April, then reverse one hour in October.

When Daylight-Saving Time is ON, the clock will change automatically as follows:

- **First Sunday of April** : At 2 AM the clock immediately changes to 3 AM. Any timer programming you have set to occur between 2 AM and 3 AM will not record.
- **Last Sunday of October** : At 2 AM the clock immediately changes to 1 AM.

**Make sure ...**

- Press the POWER button to turn on the TV/VCR.

#### 1 Select "SETTING CLOCK"

Press the MENU button on the remote control.

Press the PLAY/▲ or STOP/▼ button to point to "SETTING CLOCK".

Then, press the F.FWD/▶ button.

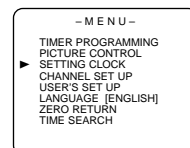

#### 2 Set "D.S.T." (Daylight-Saving Time) to [ON]

Press the PLAY/▲ or STOP/▼ button to point to "D.S.T.".

Then, press the F.FWD/▶ or REW/◀ button until [ON] appears.

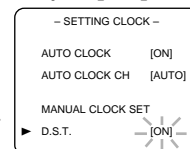

#### 3 Exit the Daylight-Saving Time mode

Press the MENU button on the remote control to return to TV mode.

## TO CANCEL THE DAYLIGHT-SAVING TIME

Repeat steps [1] to [2], select [OFF] using the F.FWD/▶ or REW/◀ button. Then, press the MENU button to return to TV mode.

# TV OPERATION

## WATCHING A TV PROGRAM

### 1 Turn on the TV/VCR

Press the POWER button to turn on the TV/VCR.

### 2 Select the channel number

Press the CHANNEL ▲ or ▼ button to select your desired channel number or press the number buttons on the remote control.

**Remember:** If the TV/VCR is connected to a cable box or satellite box, the TV/VCR must be on CH3 or CH4, then the channel to be viewed must be selected on the cable box or satellite box.

### 3 Adjust sound

Press the VOLUME ▲ or ▼ button to adjust the volume.

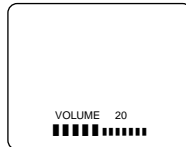

## GAME MODE

This function enables you to decrease the TV screen contrast and making it suitable for use with a TV GAME.

**NOTE:** This function can not be set during recording.

Press the GAME button on the remote control. "GAME" appears on the screen.

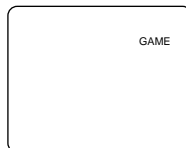

When you press the GAME button;

- The TV/VCR comes on automatically if it is off.
- The TV/VCR will be in external input mode automatically.

### TO CANCEL THE GAME MODE

Press the GAME button or CHANNEL ▲ or ▼ button on the remote control.

## DEGAUSSING

Magnetism from nearby appliances might affect the color of the TV picture.

If this happens, move this unit away from the appliance. If the color is still not correct, disconnect power cord from AC outlet then reconnect it after 30 minutes.

## PICTURE CONTROL

The TV/VCR's picture controls – **BRIGHT, CONTRAST, COLOR, TINT** and **SHARPNESS** – are preset to factory specifications. Although they are usually the best, you may need to make some further adjustments for a natural looking image.

### NOTES:

- Procedures must be followed within 5 seconds or the Picture Control mode will be cancelled.
- When setting the Picture Control, the Game mode will be cancelled.

### Make sure ...

- TV/VCR power must be turned on.

### 1 Select "PICTURE CONTROL"

Press the MENU button on the remote control.

Press the PLAY/▲ or STOP/▼ button to point to "PICTURE CONTROL".

Then, press the F.FWD/▶ button.

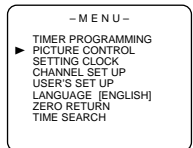

### 2 Select item you want to adjust

Press the PLAY/▲ or STOP/▼ button until desired control is displayed.

BRIGHT  
CONTRAST  
COLOR  
TINT  
SHARPNESS

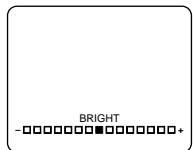

### 3 Adjust the picture control

Press the F.FWD/▶ or REW/◀ button to adjust to your desired level.

	REW/◀	F.FWD/▶
<b>BRIGHT</b>	to decrease brightness	to increase brightness
<b>CONTRAST</b>	to decrease contrast	to increase contrast
<b>COLOR</b>	to pale	to brilliant
<b>TINT</b>	to purple	to green
<b>SHARPNESS</b>	to soft	to clear

- If there is a power failure of any kind, the unit will retain its memory for this feature.

# PLAYBACK

This TV/VCR will operate with any cassette that has the **VHS** mark. For best results, we recommend the use of high-quality tapes. Do not use poor quality or damaged tapes.

## INSERTING A CASSETTE

Insert the cassette in the direction as shown. Push in gently, but continuously, on the center-back of the cassette until it is drawn into the TV/VCR. The TV/VCR will automatically turn on.

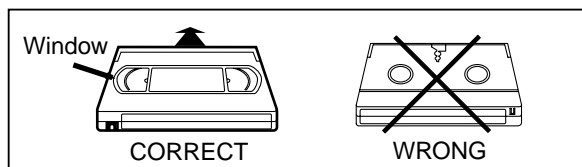

## PRECAUTIONS

- Avoid moisture. Moisture condensation may occur on the tape if it is moved from a cold place to a warm place or visa versa. Before using a tape with these conditions, to avoid damage of the tape and your TV/VCR, wait until the tape has warmed to room temperature and the moisture has evaporated.
- Avoid extreme heat, high humidity and magnetic fields.
- Do not tamper with the cassette mechanism.
- Do not touch the tape with your fingers.

## NORMAL PLAYBACK

### Make sure ...

- TV/VCR power must be turned on.

### 1 Insert a prerecorded tape

If the erase-protection tab has been removed, the TV/VCR will start playback automatically.

### 2 To begin playback

Press the PLAY button.

**Note:** If any menu is activated on the screen, the PLAY button does not function. Press the MENU button to clear the menu. then, press the PLAY button.

If a tape is already on the TV/VCR with power off,

A) Press the PLAY button on the TV/VCR. Power will automatically turn on and playback will start. (Direct button operation)

B) Use the remote control;

Press the POWER button to turn the TV/VCR on, and then press the PLAY button on the remote control.



### 3 To stop playback

Press the STOP button when playback is completed.

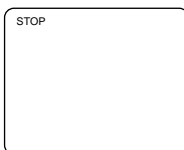

## AUTO REPEAT PLAYBACK

The TV/VCR has the auto repeat function that allows you to repeat a tape indefinitely without touching the PLAY button.

**ALL REPEAT:** Repeat playback from the beginning to the end of the tape.

**BLANK REPEAT:** Repeat playback from the beginning to a blank part, which is blank for more than 10 seconds.

### 1 Select "USER'S SET UP"

Press the MENU button on the remote control.

Press the PLAY/▲ or STOP/▼ button to point to "USER'S SET UP".

Then, press the F.FWD/▶ button.

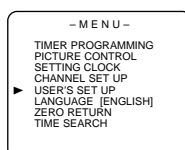

### 2 Select "ALL" or "BLANK"

Press the PLAY/▲ or STOP/▼ button to point to "REPEAT PLAY".

Press the F.FWD/▶ or REW/◀ button repeatedly until your desired selection [ALL] or [BLANK] appears.

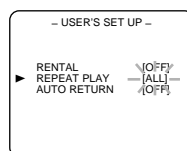

### 3 Exit the Repeat Play setting

Press the MENU button on the remote control to return to the TV mode.

### 4 Start playback

Press the PLAY button to start the Repeat Play. "REPEAT PLAY ▶" appears.

- Once you select the Repeat Play mode, it stays in effect even after you turn off the TV/VCR.
- If the Rental mode is set [ON], the "RENTAL PLAY ▶" display has priority.

## TO CANCEL THE REPEAT PLAY MODE

Repeat steps [1] and [2], select [OFF] using the F.FWD/▶ or REW/◀ button on the remote control. Press the MENU button on the remote control to return to TV mode.

**If there is a power failure of any kind, the unit will retain its memory for this feature.**



## SEARCH

### PICTURE SEARCH

This feature is very useful in finding or skipping over a particular scene on a tape. In this mode, the sound will be muted.

- 1) You may view a video tape at a high speed in either a forward or reverse direction by pressing the F.FWD or REW button during playback. (in the SP / LP / SLP modes)
- 2) Press it again and the TV/VCR will now search in super high speed. (in the LP / SLP modes only)  
**NOTE:** Tapes recorded in the SP or LP mode will display a noise bar on the TV screen and the picture may revert to Black and White. This is normal.
- 3) Press the PLAY button to return to normal speed.

### ZERO RETURN

This function allows you to search easily a beginning point that you want to review by rewinding or fast forwarding.

#### NOTE:

Zero Return **WILL NOT** work on a blank tape or a blank portion of a tape.

#### 1 Stop a tape at your desired point

Rewind or fast forward the tape to the beginning point at which you want to review.

#### 2 Reset the counter to 0:00:00

Press the COUNTER RESET button repeatedly.

#### 3 Begin recording or playback

Press the RECORD or PLAY button.

Press the STOP button when recording or playback is completed.

#### 4 To activate "ZERO RETURN" mode

Press the MENU button on the remote control.

Press the PLAY/▲ or STOP/▼ button to point to "ZERO RETURN".

Then, press the F.FWD/▶ button.

The counter will appear on the TV screen.

The tape will automatically stop when the counter returns to 0:00:00.

### TIME SEARCH

The Time Search function makes it possible to quickly advance the tape to your desired position simply by entering the exact amount of playback time you want to skip.

#### NOTES:

- Time Search can be set up to a maximum of 9 hours 50 minutes (9:50) by 10 minutes at a time.
- This function will not operate in recording mode.

*In the example below:* To watch a program after 2 hour 50 minutes from the present position, in either direction.

#### 1 Insert a tape.

#### 2 Select "TIME SEARCH" mode

Press the TIME SEARCH button (with each push it will increase by 10 minute).

#### 3 Enter your desired time

Press the PLAY/▲ or STOP/▼ button until your desired time appears. (Example: "2:50" stands for 2 hours 50 minutes)

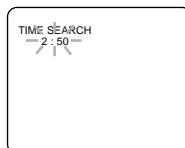

If you wish to cancel the Time Search at this point, press the MENU button on the remote control.

#### 4 Begin Time Search

By pressing the REW/◀ or F.FWD/▶ button, the TV/VCR will rewind or fast forward to the specified point.

The time counts down as the searching progresses. When 0:00 is reached, the tape will start playback automatically.

#### TO CANCEL THE TIME SEARCH at this point

Press the STOP/EJECT button on the TV/VCR or the remote control. This will delete the selected time.

## STILL PICTURE

You can view a still picture on the TV screen during playback (the Still mode). Press the PAUSE/STILL button during playback. Only tapes recorded in the SLP mode will show the least amount of lines. Press the PLAY button to return to playback.

#### NOTES:

- Usually there will be video "noise" lines (black and white streaks or dots) on the screen. This is normal.

If the tape was originally recorded in SP or LP mode, the still picture will be black and white in addition to the "noise" lines.

**This is not a fault of the machine, but is a by-product of the technology involved in producing a TV/VCR with 2 video heads.**

- If it is left in the Still mode for more than five minutes, the TV/VCR will automatically switch to the Stop mode.

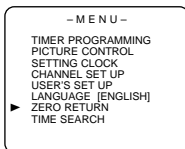

## NOISE CANCEL (in the Still mode)

This feature allows you to reposition or reduce the noise lines of a still picture. Press the PAUSE/STILL button so that the noise lines change position on the screen so you can see the picture in its entirety without distracting noise lines.

**NOTE:** This feature can be activated ONLY when viewing a tape recorded in the SLP mode. If the tape was originally recorded in the SP or LP mode, the still picture may revert to black and white in addition to the “noise bars”. This is normal.

## VERTICAL HOLD CONTROL

In the Pause/Still mode only, when the picture begins to vibrate vertically, stabilize the picture by pressing the CHANNEL ▲ or ▼ button.

**NOTE:**

If there are video noise lines on the screen, reposition or reduce them. Refer to “NOISE CANCEL”.

## TRACKING ADJUSTMENT

- Tracking adjustment will be set automatically (Digital Tracking function) when you start playback.
- However when playing pre-recorded tapes or tapes recorded on units other than your own, noise lines (black and white streaks) may appear on the playback picture. If this occurs, you can adjust the tracking control manually by pressing the CHANNEL ▲ or ▼ button until the streaks disappear. To return to the DTR function, stop the tape once and start playback again.

## RENTAL PLAYBACK

This function enables you to improve the picture quality when playing back worn cassettes such as rented tapes.

### 1 Select “USER’S SET UP”

Press the MENU button on the remote control.

Press the PLAY/▲ or STOP/▼ button to point to “USER’S SET UP”.

Then, press the F.FWD/▶ button.

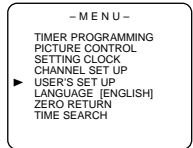

### 2 Set “RENTAL” to [ON]

Press the PLAY/▲ or STOP/▼ button to point to “RENTAL”.

Press the F.FWD/▶ or REW/◀ button until [ON] appears.

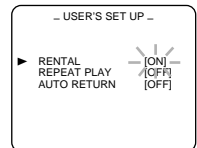

### 3 Exit the Rental setting

Press the MENU button on the remote control to return to the TV mode.

### 4 Start playback

Press the PLAY button to start playback. “RENTAL PLAY ▶” appears.

- Once you select the Rental mode, it stays in effect even after you turn off the TV/VCR.

## TO CANCEL THE RENTAL MODE

Repeat steps [1] and [2], select [OFF] using the F.FWD/▶ or REW/◀ button on the remote control. Press the MENU button on the remote control to return to TV mode.

**If there is a power failure of any kind, the unit will retain its memory for this feature.**

## RECORDING

### TWO DIFFERENT TAPE SPEEDS

Before recording, select the tape speed from : **SP mode** (Standard Play) or **SLP mode** (Super Long Play).

The table below shows the maximum recording/playback time using T60, T120 or T160 tapes in each mode.

Tape Speed	Recording/Playback Time			
	Type of tape	T60	T120	T160
SP mode		1 hour	2 hours	2-2/3 hours
SLP mode		3 hours	6 hours	8 hours

**Note:** You can play back a tape recorded in LP mode (Long Play).

### ERASE PREVENTION

You can prevent accidental erasing of recording by breaking off the tab on the back edge of the cassette.

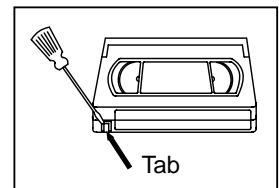

If you decide to record on the tape again, cover the hole with plastic tape.

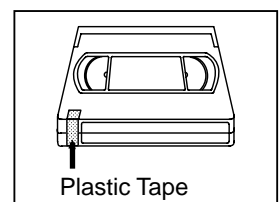

### Make sure ...

- TV/VCR power must be turned on.
- Insert a cassette tape with its erase prevention tab in place. (If necessary, rewind or fast forward the tape to the point at which you want to begin recording.)

**NOTE:** This unit will ONLY record and view the same channel.

## NORMAL RECORDING

You can ONLY watch the same TV program that is being recorded.

### 1 Select the channel to be recorded

Press the number buttons on the remote control or the CHANNEL ▲ or ▼ button.

Remember: If the TV/VCR is connected to a cable box or satellite box, the TV/VCR must be on CH3 or CH4, then the channel to be recorded must be selected on the cable box or satellite box.

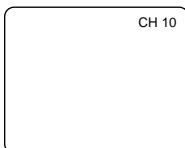

### 2 Select the tape speed

Press the SPEED button to select the desired tape speed (SP/ SLP).

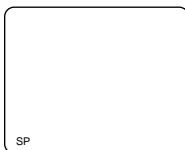

### 3 Begin recording

Press the RECORD button.

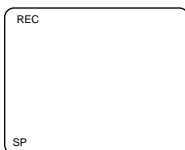

### 4 Stop recording

Press the STOP button when recording is completed.

## SKIPPING UNWANTED SCENES DURING RECORDING

Press the PAUSE/STILL button to temporarily stop recording. Press the PAUSE/STILL or RECORD button to resume recording.

### NOTE:

- After five minutes, the TV/VCR will automatically switch to the Recording mode to prevent tape damage.

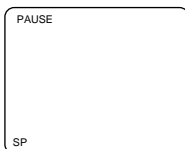

## OTR (One Touch Recording)

This function enables you to set a recording length simply by pressing the REC/OTR button on the TV/VCR.

### Make sure ...

- TV/VCR power must be turned on.
- Insert a cassette tape with its erase prevention tab in place. (If necessary, rewind or fast forward the tape to the point at which you want to begin recording.)

### NOTES:

- This function CANNOT be done from the remote control.
- Recording starts immediately when the REC/OTR button is pressed.
- When the REC/OTR button is pressed 18 times, the TV/VCR returns to the Normal Recording mode.
- To stop the OTR operation, press the STOP button on the TV/VCR or on the remote control.
- To show the remaining time, press the DISPLAY button on the remote control so that "OTR" appears on the TV screen. (It will show up momentarily then disappear.)
- Recording stops when 0:00 is reached.
- Please note that in the SLP mode maximum recording time, assuming the tape is started at the beginning, is 8 hours using T-160 (or 6 hours using T-120).
- If the tape runs out before the end time, the TV/VCR will switch to the Stop mode immediately, ejects the tape and turns itself off.

### 1 Select the channel to be recorded

Press the number buttons on the remote control or the CHANNEL ▲ or ▼ button.

**Remember:** If the TV/VCR is connected to a cable box or satellite box, the TV/VCR must be on CH3 or CH4, then the channel to be recorded is selected on the cable box or satellite box.

### 2 Select the tape speed

Press the SPEED button to select the desired tape speed (SP/ SLP).

### 3 Begin OTR

Press the REC/OTR button on the TV/VCR as many times as needed. The recording length will be determined by the number of times you press the REC/OTR button. Each additional push will increase the recording time by 30 minutes. It is set up to 8 hours.

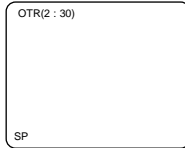

Push(es)	Display	Recording length
1 push		(normal recording)
2 pushes	0:30	30 minutes
3 pushes	1:00	60 minutes
↓	↓	↓
17 pushes	8:00	480 minutes

## TIMER RECORDING

You may set the TV/VCR to start and end a recording while you are away. You can set 8 programs to record on specific days, daily or weekly within a 1 year period.

*In the example below, the timer is being set to record:*

DATE: July 6th, 2001  
 SETTING TIME: from 7:30PM to 8:50PM  
 CHANNEL: CH61  
 TAPE SPEED: SP

#### Make sure ...

- If a cable box or satellite box is connected with the TV/VCR you will be limited to record only one channel. And the channel selector on the TV/VCR must be selected to the output channel of the boxes CH 3 or CH 4 and then the actual channel to be recorded must be selected on the boxes.
- Clock must be set to the correct time and date before setting the timer.
- TV/VCR power must be turned on to program it.
- Insert a cassette tape with its erase prevention tab in place. (If necessary, rewind or fast forward the tape to the point at which you want to begin recording.)
- The channel you want to record is properly set in advance.

### Avoid over lap of programs ...

There is a chance that a program will not be recorded, when programs overlap;

- The program with an earlier start has priority.
- Once the earliest program finishes, the overlapping programs will begin recording in sequence.
- The illustration below demonstrates the sequence of recordings.

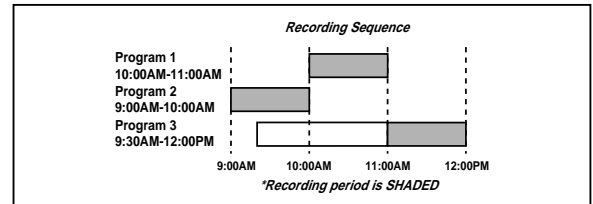

### 1 Select "TIMER PROGRAMMING"

Press the MENU button on the remote control.

Confirm "TIMER PROGRAMMING" is pointed by pressing the PLAY/▲ button.

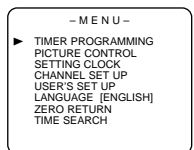

And press the F.FWD/▶ button.

- If you have not yet set the clock, "MANUAL CLOCK SET" appears. If so, follow steps [3] to [8] on page 12. Then set the timer recording.

### 2 Select your desired program position (1-8)

Press the PLAY/▲ or STOP/▼ button to select the desired program position.

Then, press the F.FWD/▶ button.

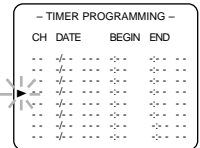

### 3 Set the channel number

Press the PLAY/▲ or STOP/▼ button until the desired channel number appears.

(Example: CH61)

Then, press the F.FWD/▶ button.

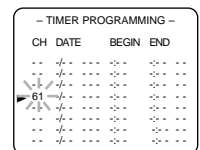

Remember: If the TV/VCR is connected to a cable box or satellite box, the TV/VCR must be on CH3 or CH4, then the channel to be recorded is selected on the cable box or satellite box.

### 4 Select once, every day or weekly recording

#### For once recording :

Press the PLAY/▲ (up) button until the desired date appears. (Example: "7/06" for July 6th). Then, press the F.FWD/▶ button.

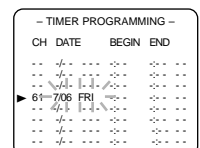

**For every day recording :** To record a TV program at the same time on the same channel every day.

(Example: Monday through Sunday)

Press the STOP/▼ (down) button until “EVRY DAY” appears. Then, press the F.FWD/▶ button.

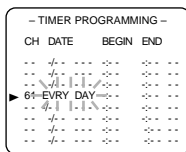

**For weekly recording :** To record a TV program at the same time on the same channel every week.

(Example: every Monday)

Press the STOP/▼ (down) button until “EVRY” and your desired day of the week appear together. Then, press the F.FWD/▶ button.

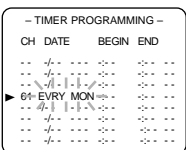

### 5 Set beginning hour

Press the PLAY/▲ or STOP/▼ button until the desired hour appears. (Example: “7, PM” for 7:30PM) Then, press the F.FWD/▶ button.

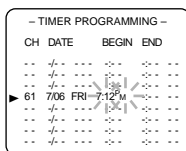

### 6 Set beginning minute

Press the PLAY/▲ or STOP/▼ button until the desired minute appears. (Example: “30” for 7:30PM) Then, press the F.FWD/▶ button.

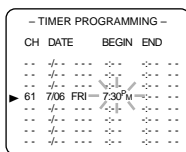

### 7 Set end hour

Press the PLAY/▲ or STOP/▼ button until the desired hour appears. (Example: “8, PM” for 8:50PM) Then, press the F.FWD/▶ button.

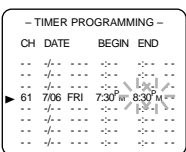

### 8 Set end minute

Press the PLAY/▲ or STOP/▼ button until the desired minute appears. (Example: “50” for 8:50PM) Then, press the F.FWD/▶ button.

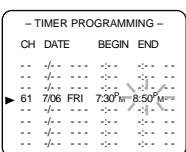

### 9 Set the tape speed

Press the PLAY/▲ or STOP/▼ button until the desired tape speed appears. (Example: SP)

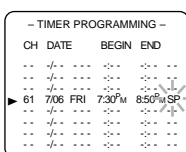

## 10 Finish setting the program

Press the F.FWD/▶ or REW/◀ button. The program is now completed.

- To set another program, repeat steps [2] to [10].
- Press the MENU button on the remote control to return to original mode.

## 11 Set the timer

Press the POWER button to set automatic timer recording. The TIMER REC indicator lights up.

- You must turn off the TV/VCR to activate automatic timer recording.

If power is not turned off and you continue watching TV, “TIMER REC STANDBY” starts flashing on the TV screen 2 minutes before the programmed start time.

To shift the time schedule of an automatic timer recording.

- 1) Press the POWER button.
- 2) Repeat step [1] on page 20.
- 3) Press the RECORD button and select the desired program using the PLAY/▲ or STOP/▼ button.
- 4) Press the RECORD button again.

Each additional push will shift forward the begin/end time for recording by 10 minutes. When the recording is already in progress, each additional push will shift forward the end time only. If you want to cancel while setting, press the PAUSE/STILL button on the remote control. The recording time returns to the original time.

**NOTE:** When you shift forward the time schedule during recording, the recording speed will automatically be set to the SLP mode.

- 5) Press the F.FWD/▶ or REW/◀ button to exit the setting menu. Then press the MENU button on the remote control to return to original mode.

## TO CORRECT A PROGRAM

- **While setting a program;** press the REW/◀ button to go back one step and enter the correct numbers using the PLAY/▲ or STOP/▼ button.

- **After setting a program;**

- 1) Press the POWER button.
- 2) Repeat steps [1] - [2] on page 20.
- 3) Press the F.FWD/▶ button (or press the REW/◀ button to go back one step) until the part you want to correct begins flashing, then make the changes pressing the PLAY/▲ or STOP/▼ button.
- 4) Press the POWER button to set automatic timer recording.

## TO CANCEL AN AUTOMATIC TIMER RECORDING

- **After setting a program;**
  - 1) Press the POWER button.
  - 2) Repeat steps [1] ~ [2] on page 20 and select a program you want to cancel.
  - 3) Press the T-PROG. CLEAR button.
  - 4) Press the MENU button on the remote control to return to TV mode.
- **While recording is in progress;**
  - 1) Press POWER button.
  - 2) Press the STOP/EJECT button on the TV/VCR.

## TO CHECK THE BEGIN/END TIME

- 1) Press the POWER button so that the REC indicator goes off.
- 2) Press the MENU button on the remote control.
- 3) Confirm "TIMER PROGRAMMING" is pointed.
- 4) Press the F.FWD/▶ button. The details of programs appear on the TV screen.
- 5) Press the MENU button on the remote control to return to TV mode.

## HINTS FOR AUTOMATIC TIMER RECORDING

- Make sure the channel you want to record is properly set in advance.
- It is not necessary to press the RECORD button for timer recording.
- Recording begins automatically at the Start time.
- If you are recording using a Timer mode, you may not operate the unit manually.
- The erase-prevention tab on the cassette must be in place (or you must put tape over the hole).
- If the erase-prevention tab is removed, the cassette will be ejected when the POWER button is pressed to off.
- If the tape runs out before the end time, the TV/VCR will switch to the Stop mode immediately, and the tape will be ejected.

## AUTO RETURN

With this feature, after timer recording is finished, the beginning of the recorded program(s) can be searched for automatically.

### 1 Select "USER'S SET UP"

Press the MENU button on the remote control.

Press the PLAY/▲ or STOP/▼ button to point to "USER'S SET UP". Then, press the F.FWD/▶ button.

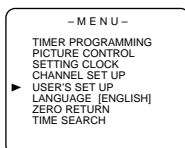

### 2 Set "AUTO RETURN" to [ON]

Press the PLAY/▲ or STOP/▼ button to point to "AUTO RETURN".

Press the F.FWD/▶ or REW/◀ button until [ON] appears. Then,

press the MENU button on the remote control to return to TV mode.

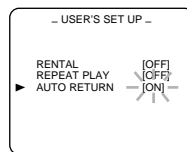

### 3 Auto Return will begin

When all the timer recordings are completed, the TV/VCR will rewind to the beginning of the recorded program(s).

#### NOTE:

- If you press the POWER button while tape is rewinding, the Auto Return will stop.

### 4 Watch the recorded program

Press the PLAY button.

## TO CANCEL THE AUTO RETURN MODE

Repeat steps [1] and [2], select [OFF] using the F.FWD/▶ or REW/◀ button. Then, press the MENU button on the remote control to return to TV mode.

**If there is a power failure of any kind, the unit will retain its memory for this feature.**

## WAKE UP TIMER

The Wake Up Timer function turns on the TV/VCR without using the POWER button after a desired period of time.

#### NOTES:

- **Use the remote control for this procedure.**
- Clock must be set to the correct time before setting the timer.
- If you want to select [TAPE], you must insert a cassette tape in the TV/VCR. The tape will start playback automatically on your desired time.

### 1 Select "WAKE UP TIMER"

Press the WAKE-UP/SLEEP button on the remote control once, and confirm "ON/OFF" is pointed.

Press the F.FWD/▶ or REW/◀ button until [ON] appears.

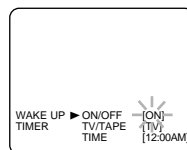

### 2 Select "TV" or "TAPE"

Press the PLAY/▲ or STOP/▼ button until to point to "TV/TAPE".

Press the F.FWD/▶ or REW/◀ button, and select [TV] or [TAPE].

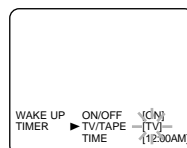

## SLEEP TIMER

### 3 Set wake up time

Press the PLAY/▲ or STOP/▼ button until to point to "TIME".

Press the F.FWD/▶ or REW/◀ button until your desired wake up time appears.

Each additional push will increase (or decrease) the time by 10 minutes.

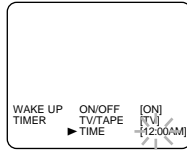

### 4 Exit the Wake Up Timer setting

Press the MENU button on the remote control to return to TV mode.

### TO CANCEL THE WAKE UP TIMER

Press the WAKE-UP/SLEEP button on the remote control once, and confirm "ON/OFF" is pointed. Press the F.FWD/▶ or REW/◀ button until [OFF] appears.

The Sleep Timer function turns off the TV/VCR without using the POWER button after a desired period of time.

#### NOTE:

- This function does not operate during Recording mode.

### 1 Select "SLEEP TIMER"

Press the WAKE UP/SLEEP button on the remote control until "SLEEP TIMER" appears.

### 2 Set sleep time

Press the PLAY/▲, STOP/▼, F.FWD/▶ or REW/◀ button until your desired sleep time appears.

Each additional push will increase the time by 30 minutes up to 120 minutes.

Press the MENU button on the remote control to exit the Sleep Timer setting.

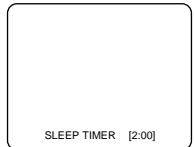

### TO CANCEL THE SLEEP TIMER

Press the WAKE-UP/SLEEP button on the remote control until "SLEEP TIMER" appears.

To view the time left for sleep timer, press the WAKE-UP/SLEEP button twice, then press the MENU button on the remote control to exit the sleep timer setting.

## COPYING A VIDEO TAPE

You can make copies of video tapes made by friends or relatives for your enjoyment.

**WARNING: Unauthorized recordings of copyrighted video tapes may be an infringement of copyright laws.**

Connect your TV/VCR and a Source (Playing) VCR using the following diagram.

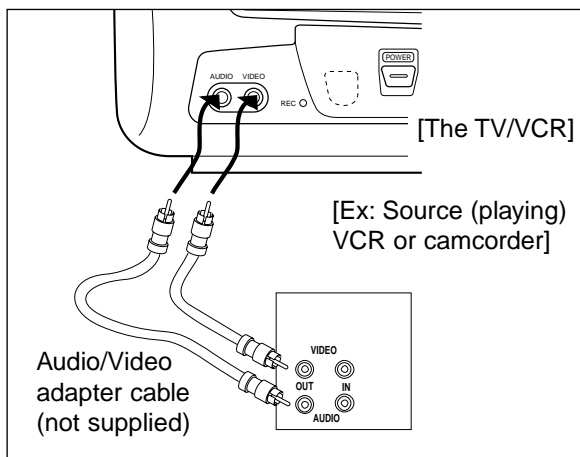

- 1) Insert a pre-recorded video cassette into the Source (Playing) VCR or camcorder.
- 2) Insert a blank video cassette, or one you want to record over, into the TV/VCR's cassette compartment.
- 3) Press the SPEED button on remote control for the TV/VCR to select the desired recording speed (SP/SLP).
- 4) Press the CHANNEL ▲ or ▼ button on the TV/VCR until "AUX" appears on the screen.  
**NOTE:** "AUX" is found below the lowest memorized channel. (Example: CH2)
- 5) Press the RECORD button on the TV/VCR.
- 6) Begin playback of the tape in the source (Playing) VCR or camcorder.  
**NOTE:** For best results during dubbing, use the TV/VCR's front panel controls whenever possible. The remote control might affect the source (Playing) VCR's playback operation.

## ON SCREEN DISPLAY

To check the Counter, Clock and Channel number on the TV screen, press the DISPLAY button on the remote control. Each time you press the DISPLAY button on the remote control, the TV screen will change as follows:

- Counter mode: After 5 seconds, only the counter remains. To clear it, press the DISPLAY button.
- Clock mode: After 5 seconds, only the clock and the channel number remain. To clear them, press the DISPLAY button.

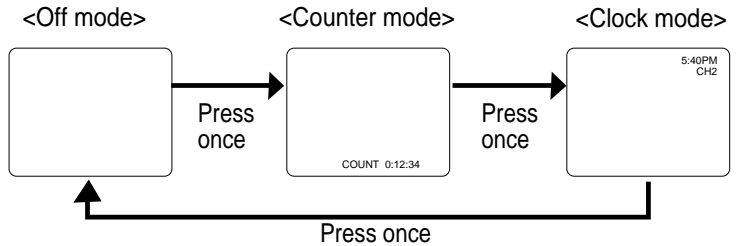

## SPECIAL FEATURES

### REAL TIME TAPE COUNTER

This shows the elapsed recording or playback time in hours, minutes, and seconds. (The displayed time will not change on a blank tape or blank portions on the tape.) The “-” indication will appear when the tape has rewound further than “0:00:00” on the tape counter.

### AUTO REWIND-EJECT

- When the end of a tape is reached during recording, playback, or fast-forward, the tape will automatically rewind to the beginning. After rewinding finishes, the TV/VCR will eject the tape and turn itself to off.
- This function is operative when Repeat Play is set to the [OFF] position.
- The tape will not auto-rewind during timer recording or One Touch Recording.

## MAINTENANCE

### CABINET CLEANING

- Wipe the front panel and other exterior surfaces of the TV/VCR with a soft cloth immersed in lukewarm water and wrung dry.
- Never use a solvent or alcohol. Do not spray insecticide liquid near the TV/VCR. Such chemicals may cause damage and discoloration to the exposed surfaces.

### AUTO HEAD CLEANING

- Automatically cleans video heads as you insert or remove a cassette, so you can see a clear picture.
- Playback picture may become blurred or interrupted while the TV program reception is clear. Dirt accumulated on the video heads after long periods of use, or the usage of rental or worn tapes can cause this problem.

If a streaky or snowy picture appears during playback, the video heads in your TV/VCR may need to be cleaned.

1. Please visit your local Audio/Video store and purchase a good quality VHS Video Head Cleaner.
2. If a Video Head Cleaner does not solve the problem, please call our help line at 1-800-968-3429, to locate an Authorized Service Center.

#### NOTES:

- Remember to read the instructions included with the video head cleaner before use.
- Clean video heads only when problems occur.

### SERVICING

- Should your TV/VCR become inoperative, do not try to correct the problem by yourself. There are no user-serviceable parts inside. Turn off, unplug the power cord, and please call our help line at 1-800-968-3429, to locate an Authorized Service Center.



## TROUBLESHOOTING GUIDE

If you have followed the instructions contained in this manual and have difficulty in operating your TV/VCR, locate the **PROBLEM** in the left column below. Check the corresponding **CORRECTIVE ACTION** column to remedy the problem.

<b>PROBLEM</b>	<b>CORRECTIVE ACTION</b>
No power.	<ul style="list-style-type: none"> <li>• Make sure the AC cord is connected to an AC outlet.</li> <li>• Make sure the car battery cord is connected to vehicle's cigarette lighter socket and to DC 13.2V (12V) jack on back of the TV/VCR.</li> <li>• Check the fuse (5A, 250V) in car battery cord.</li> <li>• Make sure the power is turned on.</li> </ul>
No picture and sound.	<ul style="list-style-type: none"> <li>• Make sure the AC cord is connected to an AC outlet.</li> <li>• Check antenna connection.</li> <li>• Let the TV/VCR program its' tuner memory.</li> </ul>
No picture or poor picture on TV/VCR.	<ul style="list-style-type: none"> <li>• Adjust direction or replace antenna.</li> <li>• Adjust picture controls.</li> </ul>
No sound or poor sound.	<ul style="list-style-type: none"> <li>• Adjust volume control on remote control or main unit.</li> <li>• Press the MUTE button to restore sound.</li> </ul>
Timer recording is not possible.	<ul style="list-style-type: none"> <li>• Make sure the timer recording is set correctly.</li> <li>• Make sure the power is off.</li> <li>• Make sure the TV/VCR clock is set correctly.</li> </ul>
Cannot go into Record mode.	<ul style="list-style-type: none"> <li>• Make sure the tape has an erase-prevention tab. If need, cover the hole with plastic tape.</li> </ul>
Playback picture is partially noisy.	<ul style="list-style-type: none"> <li>• Adjust tracking control for a better picture using the CHANNEL ▲ or ▼ button on the TV/VCR.</li> </ul>
No picture but the audio is OK in playback.	<ul style="list-style-type: none"> <li>• Head cleaning may be necessary. Refer to "AUTO HEAD CLEANING" on page 24.</li> </ul>
No operation by infrared Remote Control.	<ul style="list-style-type: none"> <li>• Make sure the AC cord is connected to an AC outlet.</li> <li>• Check batteries in remote control.</li> </ul>
Video or color fades in and out when making a copy of a video tape.	<ul style="list-style-type: none"> <li>• You can not copy a copyrighted video tape. You are experiencing copy guard protection.</li> </ul>
Can not set the auto clock to ON.	<ul style="list-style-type: none"> <li>• Make sure the AC cord is connected to an AC outlet.</li> </ul>
"DEW" appears on the screen.	<ul style="list-style-type: none"> <li>• Refer to page 4 "WARNING".</li> </ul>

# SPECIFICATIONS

## GENERAL SPECIFICATIONS

**CRT :** 9 inch in-line gun, 90° deflection tube  
**Television system :** NTSC-M  
**Video Heads :** Rotary two-head  
**Tape width :** 1/2 inch  
**Tape speed**  
     **SP :** 33.40mm/sec.  
     **LP :** 16.67mm/sec.  
     **SLP :** 11.12mm/sec.  
**Tuner channel**  
     **TV VHF Low :** #2~#6  
     **TV VHF High :** #7~#13  
     **TV UHF :** #14~#69  
**CATV**  
     **VHF :** 5A  
     **MID band :** A5~A1, A~I  
     **SUPER band :** J~W  
     **HYPER band :** W+1~W+84  
**Terminals**  
     **Antenna input :** VHF/UHF 75 ohms unbalanced  
     **Video input :** RCA connector × 1  
     **Audio input :** RCA connector × 1  
     **Earphone :** 1/8" monaural (3.5 mm)

## ELECTRICAL SPECIFICATIONS

**Video input level :** 0.5~2.0Vp-p  
**Audio input level :** -15dBs  
     **Video S/N ratio :** More than 46dB  
     **Audio S/N ratio :** More than 43dB

## OTHER SPECIFICATIONS

**Power requirement :** AC 120V/60Hz  
     DC 13.2V (12V)  
**Power consumption :** AC 55W / DC 60W  
**Dimensions :** H:13" (330mm)  
     W:12-1/8" (308mm)  
     D:12-15/16" (329mm)  
**Weight :** 18.7 lbs (8.5kg)

- **Designs and specifications are subject to change without notice and without our legal obligation.**
- **If there is a discrepancy between languages, the default language will be English.**

# CABLE CHANNEL DESIGNATIONS

If you subscribe to cable TV, the channels are displayed as 1-125. Cable companies often designate channels with letters or letter-number combinations. Please check with your local cable company. The following is a chart of common cable channel designations.

CATV channel	5A	2	3	4	5	6	7	8	9	10	11	12	13	A	B
TV Display	1	2	3	4	5	6	7	8	9	10	11	12	13	14	15
CATV channel	C	D	E	F	G	H	I	J	K	L	M	N	O	P	Q
TV Display	16	17	18	19	20	21	22	23	24	25	26	27	28	29	30
CATV channel	R	S	T	U	V	W	W+1	W+2	W+3	W+4	W+5	W+6	W+7	W+8	W+9
TV Display	31	32	33	34	35	36	37	38	39	40	41	42	43	44	45
CATV channel	W+10	W+11	W+12	W+13	W+14	W+15	W+16	W+17	W+18	W+19	W+20	W+21	W+22	W+23	W+24
TV Display	46	47	48	49	50	51	52	53	54	55	56	57	58	59	60
CATV channel	W+25	W+26	W+27	W+28	W+29	W+30	W+31	W+32	W+33	W+34	W+35	W+36	W+37	W+38	W+39
TV Display	61	62	63	64	65	66	67	68	69	70	71	72	73	74	75
CATV channel	W+40	W+41	W+42	W+43	W+44	W+45	W+46	W+47	W+48	W+49	W+50	W+51	W+52	W+53	W+54
TV Display	76	77	78	79	80	81	82	83	84	85	86	87	88	89	90
CATV channel	W+55	W+56	W+57	W+58	A-5	A-4	A-3	A-2	A-1	W+59	W+60	W+61	W+62	W+63	W+64
TV Display	91	92	93	94	95	96	97	98	99	100	101	102	103	104	105
CATV channel	W+65	W+66	W+67	W+68	W+69	W+70	W+71	W+72	W+73	W+74	W+75	W+76	W+77	W+78	W+79
TV Display	106	107	108	109	110	111	112	113	114	115	116	117	118	119	120
CATV channel	W+80	W+81	W+82	W+83	W+84										
TV Display	121	122	123	124	125										

# **SYLVANIA**

## **LIMITED WARRANTY**

FUNAI CORP. will repair this SYLVANIA product, free of charge in the USA in the event of defect in materials or workmanship as follows:

### **DURATION:**

**PARTS:** FUNAI CORP. will provide parts to replace defective parts without charge for one (1) year from the date of original retail purchase. Two (2) years for Picture Tube. Certain parts are excluded from this warranty.

**LABOR:** FUNAI CORP. will provide the labor without charge for a period of ninety (90) days from the date of original retail purchase.

### **LIMITS AND EXCLUSIONS:**

This warranty is extended only to the original retail purchaser. A purchase receipt or other proof of original retail purchase will be required together with the product to obtain service under this warranty.

This warranty shall not be extended to any other person or transferee.

This warranty is void and of no effect if any serial numbers on the product are altered, replaced, defaced, missing or if service was attempted by an unauthorized service center. This FUNAI CORPORATION Limited warranty does not apply to any product not purchased and used in the United States.

This warranty only covers failures due to defects in material or workmanship which occurs during normal use. It does not cover damage which occurs in shipment, or failures which are caused by repairs, alterations or product not supplied by FUNAI CORP., or damage which results from accident, misuse, abuse, mishandling, misapplication, alteration, faulty installation, improper maintenance, commercial use such as hotel, rental or office use of this product or damage which results from fire, flood, lightning or other acts of God.

THIS WARRANTY DOES NOT COVER PACKING MATERIALS, ANY ACCESSORIES (EXCEPT REMOTE CONTROL), ANY COSMETIC PARTS, COMPLETE ASSEMBLY PARTS, DEMO OR FLOOR MODELS.

FUNAI CORP. AND ITS REPRESENTATIVES OR AGENTS SHALL IN NO EVENT BE LIABLE FOR ANY GENERAL, INDIRECT OR CONSEQUENTIAL DAMAGES ARISING OUT OF OR OCCASIONED BY THE USE OF OR THE INABILITY TO USE THIS PRODUCT. THIS WARRANTY IS MADE IN LIEU OF ALL OTHER WARRANTIES, EXPRESS OR IMPLIED, AND OF ALL OTHER LIABILITIES ON THE PART OF FUNAI. ALL OTHER WARRANTIES INCLUDING THE WARRANTY OF MERCHANTABILITY, AND FITNESS FOR A PARTICULAR PURPOSE, ARE HEREBY DISCLAIMED BY FUNAI AND ITS REPRESENTATIVES IN THE UNITED STATES.

ALL WARRANTY INSPECTIONS AND REPAIRS MUST BE PERFORMED BY A FUNAI AUTHORIZED SERVICE CENTER. THIS WARRANTY IS VALID WHEN THE UNIT IS CARRIED-IN TO FUNAI AUTHORIZED SERVICE FACILITY.

### **IMPORTANT:**

THIS LIMITED WARRANTY GIVES YOU SPECIFIC LEGAL RIGHTS, YOU MAY HAVE OTHER RIGHTS THAT VARY FROM STATE TO STATE. IF, AT ANY TIME DURING THE WARRANTY PERIOD, YOU ARE UNABLE TO OBTAIN SATISFACTION WITH THE REPAIR OF THIS PRODUCT, PLEASE CONTACT FUNAI CORP.

### **ATTENTION:**

FUNAI CORP. RESERVES THE RIGHT TO MODIFY ANY DESIGN OF THIS PRODUCT WITHOUT PRIOR NOTICE.

**To locate your nearest SYLVANIA Authorized Service Center or for general service procedure, please call 1-800-968-3429 or write to the following:**

FUNAI CORPORATION  
Customer Service  
100 North Street; Teterboro, NJ 07608  
**Tel :1-800-968-3429**

**PLEASE DO NOT SHIP YOUR UNIT TO THE TETERBORO ADDRESS.**

# CONTROLES DE OPERACIÓN Y SUS FUNCIONES

## NOTA:

No recomendamos utilizar mandos a distancia universales. No todas las funciones pueden ser controladas mediante un mando a distancia universal. Si decide utilizar un mando a distancia universal con esta unidad, tenga en cuenta que con el número de código dado tal vez no se pueda controlar la unidad. En este caso, póngase en contacto con el fabricante del mando a distancia universal.

## - PANEL DELANTERO -

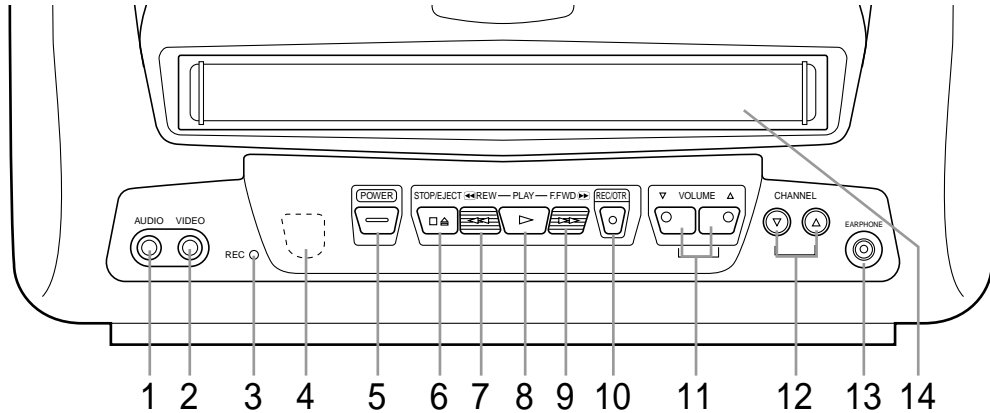

## - CONTROL REMOTO -

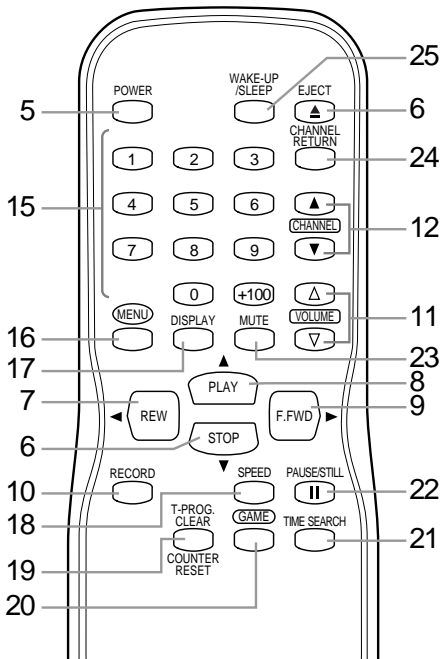

- 1 **Toma de entrada de audio (AUDIO)**– Conéctela a la toma de salida de audio de su equipo de audio, videocámara u otra videograbadora.
- 2 **Toma de entrada de vídeo (VIDEO)**– Conéctela a la toma de salida de vídeo de su videocámara u otra videograbadora.
- 3 **Indicador de grabación (RECORD)**– Parpadea durante la grabación. Se enciende en el modo de espera de la grabación con temporizador.
- 4 **Ventanilla sensora del mando a distancia**– Recibe las señales infrarrojas procedentes del mando a distancia.

5 **Botón de la alimentación (POWER)**– Púlselo para encender y apagar el televisor/videograbadora. Púlselo para activar la grabación con temporizador.

6 **Botón de parada (STOP)**– Púlselo para detener la cinta.

**Botón de expulsión (EJECT)**–Púlselo en el modo de parada para expulsar la cinta del televisor/videograbadora.

**Botón ▼**–

- Púlselo para seleccionar los modos de ajuste desde el menú de la pantalla.

- Púlselo para introducir dígitos cuando establezca un programa. (Por ejemplo: Para ajustar el reloj o establecer un programa de temporizador)

7 **Botón de rebobinado (REW)**– Púlselo para rebobinar la cinta, o para ver la imagen en retroceso rápido durante el modo de reproducción. (Búsqueda con rebobinado)

**Botón ◀**–

- Púlselo para seleccionar un modo desde un menú particular. (Por ejemplo: IDIOMA o ADJUST DE USER)

8 **Botón de reproducción (PLAY)**– Púlselo para iniciar la reproducción.

**Botón ▲**–

- Púlselo para seleccionar los modos de ajuste desde el menú de la pantalla.

- Púlselo para introducir dígitos cuando establezca un programa. (Por ejemplo: Para ajustar el reloj o establecer un programa de temporizador)

9 **Botón de avance rápido (F.FWD)**– Púlselo para avanzar rápidamente la cinta, o para ver la imagen en avance rápido durante el modo de reproducción. (Búsqueda con avance rápido)

**Botón ▶**–

- Cuando establezca un programa (por ejemplo: para ajustar el reloj o para establecer un programa de temporizador), púlselo para determinar su elección y vaya al paso siguiente que quiera introducir.

- Púlselo para determinar los modos de ajuste desde el menú de la pantalla.

- Púlselo para seleccionar un modo desde un menú particular. (Por ejemplo: IDIOMA o ADJUST DE USER)

10 **Botón de grabación (REC)**– Púlselo para iniciar la grabación manual.

**Botón de grabación de un toque (OTR)**– Activa la grabación de un toque. (Sólo en el televisor/videograbadora)

## - PANEL TRASERO -

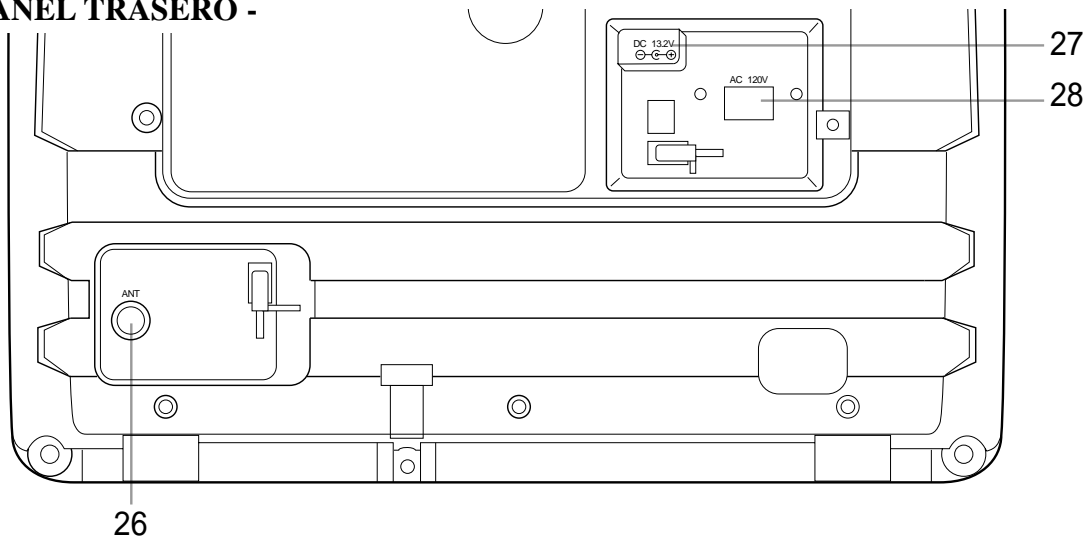

- 11 Botones de volumen (VOLUME  $\Delta$  /  $\nabla$ )**– Ajustan el nivel del volumen.
- 12 Botones de canales (CHANNEL  $\blacktriangle$  /  $\blacktriangledown$ )**– Púlselos para seleccionar los canales deseados para ver o grabar.  
Se puede mostrar el menú principal en la pantalla del televisor pulsando repetidamente este botón del televisor/videograbadora.  
**Función de seguimiento**– Pulse los botones para minimizar el ruido de vídeo (líneas o puntos en la pantalla) durante la reproducción.
- 13 Toma de auriculares (EARPHONE)**– Para conectar los auriculares (no suministrados) y escuchar en privado. La toma es mono y tiene un tamaño de 3,5 mm.
- 14 Compartimiento del videocasete**
- 15 Botones numerados**– Púlselos para seleccionar los canales deseados para ver o grabar. Para seleccionar canales del 1 al 9, pulse primero el botón 0 y luego el botón 1 a 9.  
**Botón +100**– Cuando seleccione canales de televisión por cable cuyo número sea superior al 99, pulse primero este botón, y luego pulse los dos últimos dígitos. (Para seleccionar el canal 125, pulse primero el botón “+100” y luego el “2” y el “5”.)
- 16 Botón de menú (MENU)**– Púlselo para visualizar el menú principal en la pantalla del televisor.
- 17 Botón del visualizador (DISPLAY)**– Visualiza el contador o el número del canal actual y la hora actual en la pantalla del televisor.
- 18 Botón de velocidad de cinta (SPEED)**– Púlselo para elegir la velocidad de grabación deseada: SP/SLP.
- 19 Botón T-PROG. CLEAR**– Púlselo para cancelar un programa de temporizador.  
**Botón de reposición del contador (COUNTER RESET)**– Púlselo para reponer el contador a 0:00:00.
- 20 Botón de juego (GAME)**– Establece el modo del juego y el modo de entrada externa al mismo tiempo.
- 21 Botón de búsqueda con tiempo (TIME SEARCH)**– Púlselo para activar el modo de búsqueda con tiempo.
- 22 Botón de pausa/imagen fija (PAUSE/STILL)**– Púlselo para detener temporalmente la cinta durante la grabación o para ver una imagen fija durante la reproducción.
- 23 Botón de silenciamiento (MUTE)**– Silencia el sonido. Púlselo de nuevo para recuperar el sonido.
- 24 Botón de retorno de canal (CHANNEL RETURN)**– Púlselo para volver al canal anterior. Por ejemplo, pulsando una vez este botón, la visualización del canal cambiará de 3 (canal actual) a 10 (canal anterior), y al pulsarlo por segunda vez, el canal cambiará del 10 al 3.
- 25 Botón del temporizador despertador/para dormir (WAKE UP/SLEEP)**– Ajusta el temporizador para despertarse/dormir.
- 26 Terminal de antena (ANT.)**– Para conectar una antena o sistema de televisión por cable.
- 27 DC 13.2V**– Conecta el cordón para la batería del automóvil.
- 28 AC 120V**– Conecta el cordón de CA.

## CONEXIONES DE ANTENA/CABLE

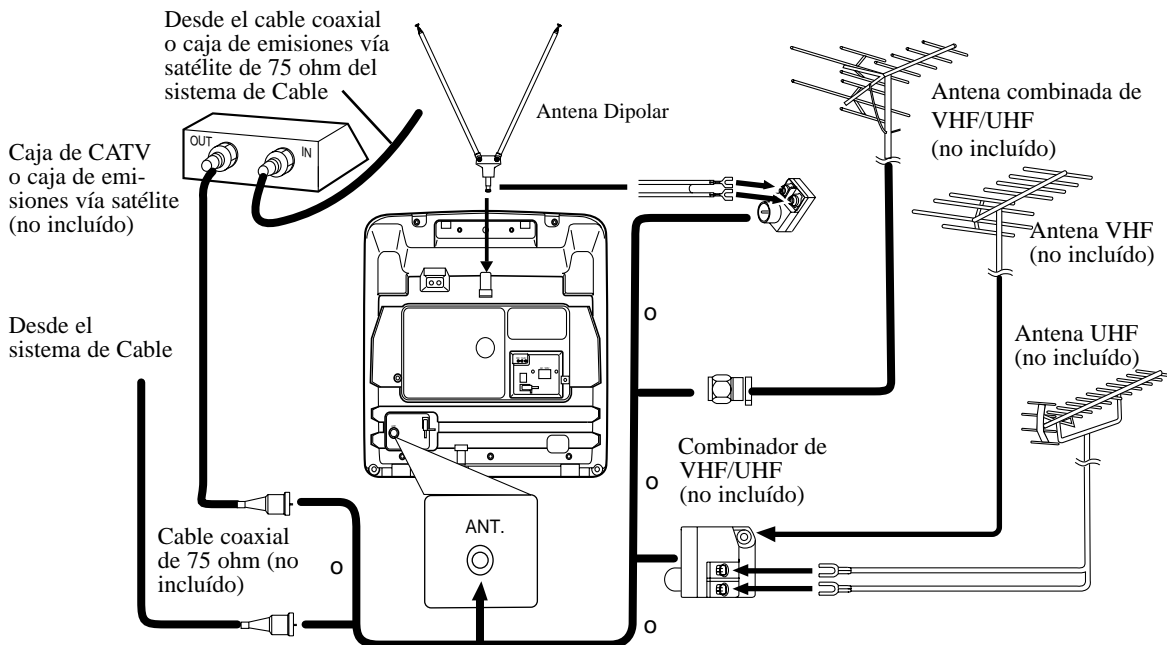

### CONEXION DE LA ANTENA BIPOLAR

1. Introduzca la varilla de la antena bipolar (accesorio) en el orificio destinado para la antena, en la parte trasera de la TV/VCR.
2. Conecte el cable bifilar plano de la antena bipolar al adaptador de acople (accesorio) de 300/75 ohm.
3. Enchufe el adaptador de acople al terminal ANT de la TV/VCR, como lo muestra el dibujo.

Para obtener una mejor recepción, extienda la antena de varilla y regule su longitud y posición. (Evite tocar su parte superior mientras hace los ajustes.)

**NOTAS:** Si es difícil obtener una buena recepción con la antena de interiores, se recomienda usar una antena de exteriores. Antes de instalar una antena de exteriores al aparato, se debe desconectar la antena de interiores.

### ANTENA COMBINADA DE VHF/UHF

Una antena de combinación de 75 ohm para VHF/UHF puede ser conectada al terminal ANT.

### ANTENAS SEPARADAS DE VHF/UHF

En algunos lugares será necesario utilizar una antena exterior.

### CABLE SIN CONVERTIDOR/DESCODIFICADOR

Utilice esta conexión si su sistema de televisión por cable se conecta directamente a su televisor/videogradora sin convertidor. Utilizando esta conexión usted podrá:

- 1) Utilizar el mando a distancia del televisor/videogradora para seleccionar canales.
- 2) Programar uno o más canales sin codificar para realizar la grabación automática con temporizador.

**NOTA:** Con esta unidad SÓLO se podrá grabar y ver un mismo canal al mismo tiempo.

### CABLE CON CONVERTIDOR/DESCODIFICADOR O CONVERTIDOR DE EMISIONES VÍA SATÉLITE

Si su servicio de televisión por cable le suministra un convertidor, o si usted utiliza un sistema de emisiones vía satélite, usted podrá utilizar las conexiones básicas.

Utilizando estas conexiones, usted también podrá grabar canales codificados. Sin embargo, la selección de los canales deberá hacerse con el convertidor de televisión por cable con el convertidor de emisiones vía satélite. Esto significa que los canales no podrán ser cambiados con el mando a distancia del televisor/videogradora. La grabación inatendida se limita a un canal cada vez.

#### PARA GRABAR UN CANAL CODIFICADO/DESCODIFICADO

1. Ajuste el selector de canales del televisor/videogradora al canal de salida del convertidor de televisión por cable o del convertidor de emisiones vía satélite. (Ej.: CA3)
2. Seleccione el canal que desee grabar de su convertidor de televisión por cable o del convertidor de emisiones vía satélite.

#### Aviso a los instaladores de sistemas CATV:

Este aviso se incluye para que los instaladores de sistemas CATV tenga en cuenta el Artículo 820-40 del NEC, que proporciona consejos para hacer una conexión apropiada a tierra y, en particular, especifica que el cable de tierra deberá conectarse a un sistema de puesta a tierra del edificio tan cerca del punto de entrada del cable como sea posible.

**ADVERTENCIA:** El conductor nunca debe ver programas del televisor o del videograbadora mientras está conduciendo un vehículo.

**PRECAUCIÓN:** Si usted usa la TV/VCR con el motor del vehículo apagado, recargue la batería del vehículo aprox. cada 4 horas de uso, para evitar que ésta se agote. Cuando termine de usar la TV/VCR, siempre desenchufe el cordón para la batería del automóvil del zócalo del encendedor de cigarrillos.

- 1) La antena de interiores incluida es adecuada para usar cuando el vehículo está inmóvil. Para obtener una mejor recepción en ruta, utilice una antena de VHF/UHF para TV móvil de alta calidad.
- 2) Enchufe el cordón para batería de automóvil al conector DC13.2V (12V) en la parte posterior de la TV/VCR. Luego conecte el otro extremo en el zócalo para el encendedor de cigarrillos del automóvil.

### NOTAS:

- Confirme que su vehículo tiene un sistema eléctrico a tierra negativo de 13.2 (12) voltios.
- Confirme que está usando sólo el cordón provisto para la batería del automóvil. El uso de otro cordón puede dañar su TV/VCR.
- Asegúrese que no haya cenizas ni otros restos en el zócalo del encendedor.
- Asegúrese de introducir completamente el enchufe del cordón de la batería del automóvil en el zócalo del encendedor de cigarrillos.
- Siempre desenchufe primero del zócalo del encendedor de cigarrillos el cordón para la batería del coche, antes de desconectarlo de la TV/VCR.
- Antes de usar la alimentación de CA, usted debe desconectar de la TV/VCR el cordón para la batería del automóvil.
- Solamente reemplace un fusible por otro del mismo tipo 5A, 250V.

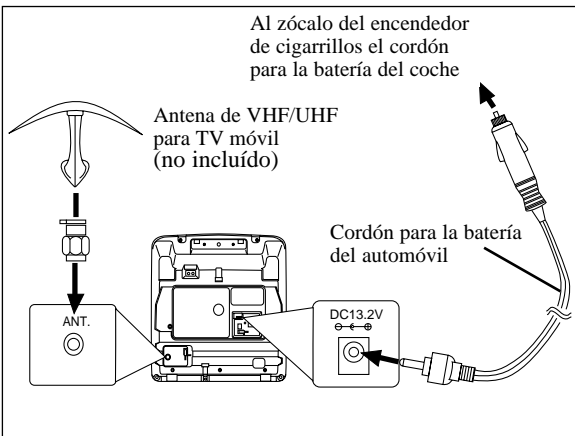

## INSTALACIÓN DE LAS PILAS

- 1) Abra la tapa del compartimiento de las pilas del mando a distancia presionándola en el sentido de la flecha.
- 2) Inserte 2 pilas tamaño "AA" en el compartimiento de las pilas, en el sentido indicado por las marcas de polaridad (+/-).
- 3) Vuelva a poner la tapa.

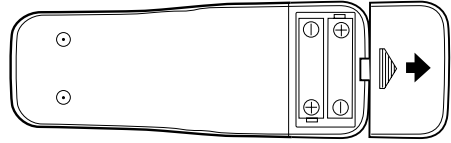

## MODO DE ENTRADA EXTERNA

Cuando utilice una señal de entrada externa (otra videograbadora o una videocámara), conecte los cables de salida de audio/vídeo del equipo de reproducción a las tomas AUDIO IN/VIDEO IN de su televisor/videograbadora. Y luego pulse el botón CHANNEL ▲ o ▼ hasta que "AUX" aparezca en la pantalla. Usted puede programar el temporizador para que explore todos los canales que puedan recibirse en su zona.

## PREPARACIÓN DE CANALES POR PRIMERA VEZ

- 1) Conecte el extremo más pequeño del cordón de CA al conector de CA de 120V en la parte posterior de la TV/VCR. Luego, enchufe el otro extremo en un tomacorriente normal de CA.

### NOTAS:

- Dede desconectar de la TV/VCR el cordón para la batería del automóvil antes de usar la alimentación de CA.
  - Si aparecen algunos dígitos en el rincón de la pantalla, pulse el botón POWER sin desenchufar el cable de alimentación.
- 2) Pulse el botón POWER para encender el televisor/videograbadora.
  - 3) Seleccione "ENGLISH" o "ESPAÑOL" utilizando el botón F.FWD/▶ o REW/◀. "[ ]" indica el idioma seleccionado.
  - 4) Pulse el botón PLAY/▲ o STOP/▼ para señalar "AUTOPRESELECCION".

Luego pulse el botón F.FWD/▶. El sintonizador explorará y memorizará todos los canales activos de su área.

### NOTAS:

- El televisor/videograbadora distingue entre los canales de televisión estándar y los canales de televisor por cable.
  - Si desea reproducir o grabar una cinta ANTES de preajustar el sintonizador, usted tendrá que pulsar el botón MENU en el mando a distancia.
  - La unidad de televisor/videograbadora puede reconocer los canales de TV como ellos de TV por cable a causa de las condiciones de recepción. En este caso, pruebe el preajuste automático de nuevo en las condiciones finas de recepción.
- 5) El sintonizador se para en el canal memorizado más bajo. Si desea recuperar canales seleccionados, usted podrá seleccionar directamente el canal deseado con los botones numerados del mando a distancia o con los botones CHANNEL ▲ o ▼.

## AJUSTE DEL RELOJ

### Cerciórese...

- La alimentación del televisor/videograbadora deberá estar conectada.

*En el ejemplo de abajo, el reloj va a ajustarse así:*

FECHA: 1 de mayo de 2001

HORA: 5:40 PM

- 1) Pulse el botón MENU en el mando a distancia. Pulse el botón PLAY/▲ o STOP/▼ para indicar "AJUSTE RELOJ". Luego, pulse el botón F.FWD/▶.
- 2) Pulse el botón PLAY/▲ o STOP/▼ para indicar "AJUSTE MANUAL RELOJ". Luego, pulse el botón F.FWD/▶.
- 3) Pulse el botón PLAY/▲ o STOP/▼ hasta que aparezca el mes deseado. (Ejemplo: Mayo - 05) Luego, pulse el botón F.FWD/▶.
- 4) Pulse el botón PLAY/▲ o STOP/▼ hasta que aparezca el día del mes deseado. (Ejemplo: 1 - 01) Luego, pulse el botón F.FWD/▶.
- 5) Pulse el botón PLAY/▲ o STOP/▼ hasta que aparezca el año deseado. (Ejemplo: 2001) Luego, pulse el botón F.FWD/▶.
- 6) Pulse el botón PLAY/▲ o STOP/▼ hasta que aparezca la hora deseada. (Ejemplo: 5, PM) Luego, pulse el botón F.FWD/▶.
- 7) Pulse el botón PLAY/▲ o STOP/▼ hasta que aparezca el minuto deseado. (Ejemplo: 40)
- 8) Pulse el botón MENU en el mando a distancia. Aunque los segundos no se visualizan, éstos empiezan a contar desde 00 cuando se pulsa MENU en el mando a distancia. Utilice esta función para sincronizar el reloj con la hora correcta.



# **SYLVANIA**

## **LIMITED WARRANTY**

FUNAI CORP. will repair this SYLVANIA product, free of charge in the USA in the event of defect in materials or workmanship as follows:

### **DURATION:**

**PARTS:** FUNAI CORP. will provide parts to replace defective parts without charge for one (1) year from the date of original retail purchase. Two (2) years for Picture Tube. Certain parts are excluded from this warranty.

**LABOR:** FUNAI CORP. will provide the labor without charge for a period of ninety (90) days from the date of original retail purchase.

### **LIMITS AND EXCLUSIONS:**

This warranty is extended only to the original retail purchaser. A purchase receipt or other proof of original retail purchase will be required together with the product to obtain service under this warranty.

This warranty shall not be extended to any other person or transferee.

This warranty is void and of no effect if any serial numbers on the product are altered, replaced, defaced, missing or if service was attempted by an unauthorized service center. This FUNAI CORPORATION Limited warranty does not apply to any product not purchased and used in the United States.

This warranty only covers failures due to defects in material or workmanship which occurs during normal use. It does not cover damage which occurs in shipment, or failures which are caused by repairs, alterations or product not supplied by FUNAI CORP., or damage which results from accident, misuse, abuse, mishandling, misapplication, alteration, faulty installation, improper maintenance, commercial use such as hotel, rental or office use of this product or damage which results from fire, flood, lightning or other acts of God.

THIS WARRANTY DOES NOT COVER PACKING MATERIALS, ANY ACCESSORIES (EXCEPT REMOTE CONTROL), ANY COSMETIC PARTS, COMPLETE ASSEMBLY PARTS, DEMO OR FLOOR MODELS.

FUNAI CORP. AND ITS REPRESENTATIVES OR AGENTS SHALL IN NO EVENT BE LIABLE FOR ANY GENERAL, INDIRECT OR CONSEQUENTIAL DAMAGES ARISING OUT OF OR OCCASIONED BY THE USE OF OR THE INABILITY TO USE THIS PRODUCT. THIS WARRANTY IS MADE IN LIEU OF ALL OTHER WARRANTIES, EXPRESS OR IMPLIED, AND OF ALL OTHER LIABILITIES ON THE PART OF FUNAI. ALL OTHER WARRANTIES INCLUDING THE WARRANTY OF MERCHANTABILITY, AND FITNESS FOR A PARTICULAR PURPOSE, ARE HEREBY DISCLAIMED BY FUNAI AND ITS REPRESENTATIVES IN THE UNITED STATES.

ALL WARRANTY INSPECTIONS AND REPAIRS MUST BE PERFORMED BY A FUNAI AUTHORIZED SERVICE CENTER. THIS WARRANTY IS VALID WHEN THE UNIT IS CARRIED-IN TO FUNAI AUTHORIZED SERVICE FACILITY.

### **IMPORTANT:**

THIS LIMITED WARRANTY GIVES YOU SPECIFIC LEGAL RIGHTS, YOU MAY HAVE OTHER RIGHTS THAT VARY FROM STATE TO STATE. IF, AT ANY TIME DURING THE WARRANTY PERIOD, YOU ARE UNABLE TO OBTAIN SATISFACTION WITH THE REPAIR OF THIS PRODUCT, PLEASE CONTACT FUNAI CORP.

### **ATTENTION:**

FUNAI CORP. RESERVES THE RIGHT TO MODIFY ANY DESIGN OF THIS PRODUCT WITHOUT PRIOR NOTICE.

**To locate your nearest SYLVANIA Authorized Service Center or for general service procedure, please call 1-800-968-3429 or write to the following:**

FUNAI CORPORATION  
Customer Service  
100 North Street; Teterboro, NJ 07608

**Tel :1-800-968-3429**

**PLEASE DO NOT SHIP YOUR UNIT TO THE TETERBORO ADDRESS.**

## Free Manuals Download Website

<http://myh66.com>

<http://usermanuals.us>

<http://www.somanuals.com>

<http://www.4manuals.cc>

<http://www.manual-lib.com>

<http://www.404manual.com>

<http://www.luxmanual.com>

<http://aubethermostatmanual.com>

Golf course search by state

<http://golfingnear.com>

Email search by domain

<http://emailbydomain.com>

Auto manuals search

<http://auto.somanuals.com>

TV manuals search

<http://tv.somanuals.com>