

OWNER'S MANUAL

SYLVANIA

COLOR TV/VCR

6313CE (13 inch)

6319CE (19 inch)

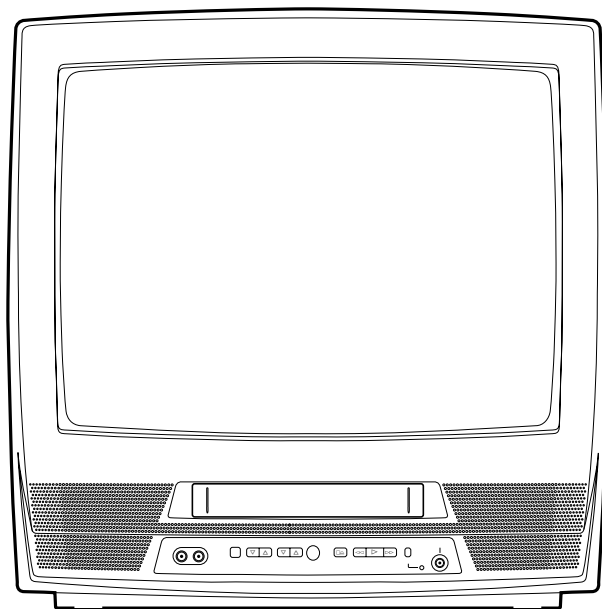

19" MODEL ILLUSTRATED

INSTRUCCIONES EN ESPAÑOL INCLUIDAS.

If you need additional assistance for set-up or operating after reading owner's manual, please call **TOLL FREE : 1-800-968-3429**.
Or visit our **WEB SITE** at <http://www.SylvaniaConsumerElectronics.com>

VHS

Please read before using this equipment

Download from [Www.Somanuals.com](http://www.Somanuals.com). All Manuals Search And Download.

WARNING: TO REDUCE THE RISK OF FIRE OR ELECTRIC SHOCK, DO NOT EXPOSE THIS APPLIANCE TO RAIN OR MOISTURE.



CAUTION
RISK OF ELECTRIC SHOCK
DO NOT OPEN



CAUTION: TO REDUCE THE RISK OF ELECTRIC SHOCK, DO NOT REMOVE COVER (OR BACK). NO USER SERVICEABLE PARTS INSIDE. REFER SERVICING TO QUALIFIED SERVICE PERSONNEL.



THIS SYMBOL INDICATES THAT DANGEROUS VOLTAGE CONSTITUTING A RISK OF ELECTRIC SHOCK IS PRESENT WITHIN THIS UNIT.



THIS SYMBOL INDICATES THAT THERE ARE IMPORTANT OPERATING AND MAINTENANCE INSTRUCTIONS IN THE LITERATURE ACCOMPANYING THE APPLIANCE.

The caution marking is located on the rear of the cabinet.

IMPORTANT SAFEGUARDS

1. Read instructions - All the safety and operating instructions should be read before the appliance is operated.

2. Retain Instructions - The safety and operating instructions should be retained for future reference.

3. Heed Warnings - All warnings on the appliance and in the operating instructions should be adhered to.

4. Follow Instructions - All operating and use instructions should be followed.

5. Cleaning - Unplug unit from the wall outlet before cleaning. Do not use liquid cleaners or aerosol cleaners. Use a damp cloth for cleaning.

EXCEPTION: A product that is meant for uninterrupted service and, that for some specific reason, such as the possibility of the loss of an authorization code for a CATV converter, is not intended to be unplugged by the user for cleaning or any other purpose, may exclude the reference to unplugging the appliance in the cleaning description otherwise required in item 5.

6. Attachments - Do not use attachments not recommended by the unit manufacturer as they may cause hazards.

7. Water and Moisture - Do not use this unit near water-for example, near a bath tub, wash bowl, kitchen sink, or laundry tub, in a wet basement, or near a swimming pool, and the like.

8. Accessories - Do not place this unit on an unstable cart, stand, tripod, bracket, or table. The unit may fall, causing serious injury to someone, and serious damage to the appliance. Use only with a cart, stand, tripod, bracket, or table recommended by the manufacturer, or sold with the unit. Any mounting of the appliance should follow the manufacturer's instructions and should use a mounting accessory recommended by the manufacturer. An appliance and cart combination should be moved with care. Quick stops, excessive force, and uneven surfaces may cause the appliance and cart combination to overturn.

PORTABLE CART WARNING



S3126A

AMEUBLES - Cet appareil ne doit être placé que sur un meuble (avec ou sans roulettes) recommandé par le fabricant. Si vous l'installez sur un meuble à roulettes, déplacez les deux ensembles avec précaution. Un arrêt brusque, l'utilisation d'une force excessive et des surfaces irrégulières risquent de déstabiliser l'ensemble et de le renverser.



9. Ventilation - Slots and openings in the cabinet and the back or bottom are provided for ventilation and to ensure reliable operation of the unit and to protect it from overheating, and these openings must not be blocked or covered. The openings should never be blocked by placing the unit on a bed, sofa, rug, or other similar surface. This unit should never be placed near or over a radiator or heat register. This unit should not be placed in a built-in installation such as a bookcase or rack unless proper ventilation is provided or the manufacturer's instructions have been adhered to.

10. Power Sources - This unit should be operated only from the type of power source indicated on the marking label. If you are not sure of the type of power supply to your home, consult your appliance dealer or local power company. For units intended to operate from battery power, or other sources, refer to the operating instructions.

11. Grounding or Polarization - This unit is equipped with a polarized alternating-current line plug (a plug having one blade wider than the other). This plug will fit into the power outlet only one way. This is a safety feature. If you are unable to insert the plug fully into the outlet, try reversing the plug. If the plug should still fail to fit, contact your electrician to replace your obsolete outlet. Do not defeat the safety purpose of the polarized plug.

12. Power-Cord Protection - Power-supply cords should be routed so that they are not likely to be walked on or pinched by items placed upon or against them, paying particular attention to cords at plugs, convenience receptacles, and the point where they exit from the appliance.

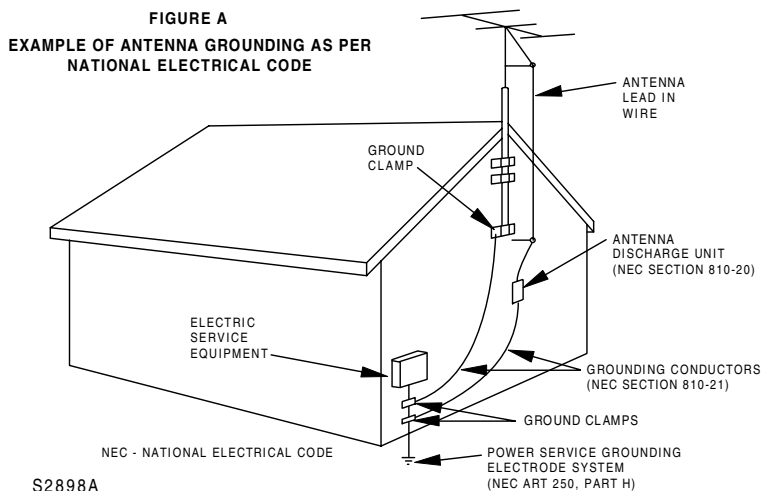

13. Outdoor Antenna grounding - If an outside antenna or cable system is connected to the unit, be sure the antenna or cable system is grounded so as to provide some protection against voltage surges and built-up static charges. Article 810 of the National Electrical Code, ANSI/NFPA No. 70, provides information with respect to proper grounding of the mast and supporting structure, grounding of the lead-in wire to an antenna discharge unit, size of grounding conductors, location of antenna-discharge unit, connection to grounding electrodes, and requirements for the grounding electrode. (Fig. A)

14. Lightning - For added protection for this unit receiver during a lightning storm, or when it is left unattended and unused for long periods of time, unplug it from the wall outlet and disconnect the antenna or cable system. This will prevent damage to the unit due to lightning and power-line surges.

15. Power Lines - An outside antenna system should not be located in the vicinity of overhead power lines or other electric light or power circuits, or where it can fall into such power lines or circuits. When installing an outside antenna system, extreme care should be taken to keep from touching such power lines or circuits as contact with them might be fatal.

16. Overloading - Do not overload wall outlets and extension cords as this can result in a risk of fire or electric shock.

17. Object and Liquid Entry - Never push objects of any kind into this unit through openings as they may touch dangerous voltage points or short out parts that could result in a fire or electric shock. Never spill liquid of any kind on the unit.

18. Servicing - Do not attempt to service this unit yourself as opening or removing covers may expose you to dangerous voltage or other hazards. Refer all servicing to qualified service personnel.

19. Damage Requiring Service - Unplug this unit from the wall outlet and refer servicing to qualified service personnel under the following conditions:

- a. When the power-supply cord or plug is damaged or frayed.
- b. If liquid has been spilled, or objects have fallen into the unit.
- c. If the unit has been exposed to rain or water.
- d. If the unit does not operate normally by following the operating instructions. Adjust only those controls that are covered by the operating instructions, as improper adjustment of other controls may result in damage and will often require extensive work by a qualified technician to restore the unit to its normal operation.
- e. If the unit has been dropped or damaged in any way.
- f. When the unit exhibits a distinct change in performance, this indicates a need for service.

20. Replacement Parts - When replacement parts are required, be sure the service technician has used replacement parts specified by the manufacturer that have the same characteristics as the original part. Unauthorized substitutions may result in fire, electric shock, injury to persons or other hazards.

21. Safety Check - Upon completion of any service or repairs to this unit, ask the service technician to perform routine safety checks to determine that the unit is in proper operating condition.

22. Heat - This unit product should be situated away from heat sources such as radiators, heat registers, stoves, or other products (including amplifiers) that produce heat.

CAUTION: TO PREVENT ELECTRIC SHOCK, MATCH WIDE BLADE OF PLUG TO WIDE SLOT, FULLY INSERT.

ATTENTION: POUR ÉVITER LES CHOC ÉLECTRIQUES, INTRODUIRE LA LAME LA PLUS LARGE DE LA FICHE DANS LA BORNE CORRESPONDANTE DE LA PRISE ET POUSSER JUSQU'AU FOND.

PRECAUTIONS

LOCATION

For safe operation and satisfactory performance of your unit, keep the following in mind when selecting a place for its installation:

- Shield it from direct sunlight and keep it away from sources of intense heat.
- Avoid dusty or humid places.
- Avoid places with insufficient ventilation for proper heat dissipation. Do not block the ventilation holes at the top and bottom of the unit. Do not place the unit on a carpet because this will block the ventilation holes.
- Install the unit in a horizontal position.
- Avoid locations subject to strong vibration.
- Do not place the unit near strong magnetic fields.
- Avoid moving unit to locations where temperature differences are extreme.
- Be sure to unplug the AC power cord from the outlet before carrying the unit.

AVOID THE HAZARDS OF ELECTRICAL SHOCK AND FIRE

- Do not handle the power cord with wet hands.
- Do not pull on the power cord when disconnecting it from an AC wall outlet. Grasp it by the plug.
- If, by accident, water is spilled on your unit, unplug the power cord immediately and take the unit to our Authorized Service Center for servicing.
- Do not put your fingers or objects into the unit cassette holder.
- Do not place anything directly on top of the unit.

WARNING

Moisture condensation may occur inside the unit when it is moved from a cold place to a warm place, or after heating a cold room or under conditions of high humidity. If a tape is played in a unit which has moisture, it may damage the tape and unit. Therefore when the condensation occurs inside the unit, turn the unit on and allow at least 2 hours for the unit to dry out.

The serial number of this product may be found on the back of the unit. No other unit has the same serial number as yours. You should record the number and other vital information here and retain this book as a permanent record of your purchase to aid identification in case of theft. Serial numbers are not kept on file.

Date of Purchase	
Dealer Purchase from	
Dealer Address	
Dealer Phone No.	
Model No.	
Serial No.	

IMPORTANT COPYRIGHT INFORMATION

Unauthorized recording or use of broadcast television programming, video tape, film or other copyrighted material may violate applicable copyright laws. We assume no responsibility for the unauthorized duplication, use, or other acts which infringe upon the rights of copyright owners.

FCC WARNING- This equipment may generate or use radio frequency energy. Changes or modifications to this equipment may cause harmful interference unless the modifications are expressly approved in the instruction manual. The user could lose the authority to operate this equipment if an unauthorized change or modification is made.

RADIO-TV INTERFERENCE

This equipment has been tested and found to comply with the limits for a Class B digital device, pursuant to Part 15 of the FCC Rules. These limits are designed to provide reasonable protection against harmful interference in a residential installation.

This equipment generates, uses, and can radiate radio frequency energy and, if not installed and used in accordance with the instructions, may cause harmful interference to radio communications.

However, there is no guarantee that interference will not occur in a particular installation. If this equipment does cause harmful interference to radio or television reception, which can be determined by turning the equipment off and on, the user is encouraged to try to correct the interference by one or more of the following measures:

- 1) Reorient or relocate the receiving antenna.
- 2) Increase the separation between the equipment and receiver.
- 3) Connect the equipment into an outlet on a circuit different from that to which the receiver is connected.
- 4) Consult the dealer or an experienced radio/TV technician for help.

TABLE OF CONTENTS

<ul style="list-style-type: none"> ■ IMPORTANT SAFEGUARDS2 ■ PRECAUTIONS4 <ul style="list-style-type: none"> LOCATION4 AVOID THE HAZARDS OF ELECTRICAL SHOCK AND FIRE4 WARNING4 ■ TABLE OF CONTENTS5 ■ FEATURES6 ■ SUPPLIED ACCESSORIES6 ■ OPERATING CONTROLS AND FUNCTIONS 7 <ul style="list-style-type: none"> INSTALLING THE BATTERIES8 ■ PREPARATION FOR USE9 <ul style="list-style-type: none"> ANTENNA/CABLE CONNECTIONS9 USING FRONT A/V INPUT JACKS10 ■ TV OPERATION AND SETTINGS10 <ul style="list-style-type: none"> WATCHING A TV PROGRAM10 PICTURE CONTROL11 GAME MODE11 DEGAUSSING11 WAKE UP TIMER11 SLEEP TIMER12 CLOSED CAPTION SYSTEM12 CHANNEL SET UP12 CLOCK SET UP (AUTO / MANUAL)13 DAYLIGHT-SAVING TIME15 MENU LANGUAGE15 V-CHIP SET UP16 ■ VIDEO CASSETTE17 	<ul style="list-style-type: none"> ■ PLAYBACK18 <ul style="list-style-type: none"> NORMAL PLAYBACK18 TRACKING ADJUSTMENT18 STILL PICTURE18 ■ SPECIAL PLAYBACK19 <ul style="list-style-type: none"> RENTAL PLAYBACK19 AUTO REPEAT PLAYBACK19 ■ SEARCH20 <ul style="list-style-type: none"> ZERO RETURN20 PICTURE SEARCH20 TIME SEARCH20 ■ SPECIAL FEATURES21 <ul style="list-style-type: none"> REAL TIME TAPE COUNTER21 AUTO REWIND-EJECT21 ■ RECORDING21 <ul style="list-style-type: none"> NORMAL RECORDING21 SKIPPING UNWANTED SCENES DURING RECORDING21 OTR (One Touch Recording)22 COPYING A VIDEO CASSETTE (Requires a VCR or camcorder)22 ■ TIMER RECORDING23 <ul style="list-style-type: none"> AUTOMATIC TIMER RECORDING23 AUTO RETURN24 ■ ON SCREEN DISPLAY25 ■ CABLE CHANNEL DESIGNATIONS25 ■ TROUBLESHOOTING GUIDE26 ■ SPECIFICATIONS27 ■ MAINTENANCE27 ■ WARRANTYBack Cover
---	--

INDICE

<ul style="list-style-type: none"> CONTROLES DE OPERACIÓN Y SUS FUNCIONES28 ■ PREPARACIÓN PARA LA UTILIZACIÓN ...30 <ul style="list-style-type: none"> CONEXIONES DE ANTENA/CABLE30 ■ FUNCIONES Y AJUSTES30 <ul style="list-style-type: none"> PARA MIRAR UN PROGRAMA DE TV30 	<ul style="list-style-type: none"> AJUSTE DEL RELOJ30 IDIOMA DEL MENÚ31 REPRODUCCION NORMAL31 GRABACIÓN NORMAL31
---	--



A NOTE ABOUT RECYCLING

Batteries should never be thrown away or incinerated but disposed of in accordance with your local regulations concerning chemical wastes.

FEATURES

- **Infrared remote control**
- **Trilingual on screen menu display selectable in English, Spanish or French**
- **Real time counter**—This shows the elapsed recording or playback time in hours, minutes and seconds. The “-” indication will appear when the tape is rewound further than the tape counter position “0:00:00”.
- **181 channel capability PLL frequency synthesizer tuner with direct station call**—(A converter may be necessary to view scrambled cable channels.)
- **Auto Clock Setting**—Allows you to set the clock function from a PBS broadcast station.
- **Closed caption system**—You may view specially labeled (cc) TV programs, movies, news, prerecorded tapes, etc. with either a dialogue caption or text display added to the program.
- **Game mode**—Automatically sets external input mode and allows unit display to be suitable for use with video games.
- **Auto power on and off system**—Automatically turns on the unit when you insert the cassette, turns off after auto-rewind, and ejects when the beginning of the tape is reached.
- **Auto rewind when the end of a tape is reached** (This function doesn't occur when using timer recording.)
- **2 Step picture search operation**—You can view a video program at a high speed or super high speed in either a forward or reverse direction in LP and SLP mode. For SP mode only high speed is available.
- **Three different playback tape speeds : SP/LP/SLP**
- **Two different recording tape speeds : SP/SLP**
- **Auto Head Cleaner**—Automatically cleans video heads as you insert or remove a cassette.
- **Zero Return**—The tape returns to counter of 0:00:00 by rewinding or fast forwarding.
- **Still**—Freeze the picture at any time, for close viewing of a particular scene. Only tapes recorded in SLP mode will show a fairly clear picture.
- **Digital Auto Tracking (DTR)**—Automatically adjusts the tracking for each tape you play.
- **Rental play mode**—Improves playback picture quality from worn tapes, such as rental tapes.
- **Auto repeat**—Allows you to repeat the playing of a tape indefinitely without pressing the PLAY button.
- **Time search**—Let you set the unit to advance the tape by entering the desired playback time you want to skip.
- **OTR (One Touch Recording)**—Instant timed recording from 30 to 480 minutes is possible at the push of the REC/OTR button.
- **1 Year, 8 events (including Daily and Weekly) Timer Recording**—The built-in timer allows you to record up to 8 programs at different times on different channels up to 1 year in advance. The Daily timer allows recordings to be made of daily broadcasts and the Weekly timer allows recording to be made once a week up to the end of the tape.
- **Auto return**—After timer recording is finished, the unit can return to the beginning of the recording.
- **Wake up/Sleep timer**—Allows you to have the unit automatically turn on or off at a desired time.
- **Timer Program Extension**—Allow you to shift the time schedule for automatic timer recording.
- **V-CHIP**—Enables parents to prevent their children from watching inappropriate material on TV.

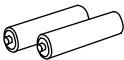
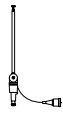
SUPPLIED ACCESSORIES

<p>Remote Control Unit</p> <p>PART NO. (N0150UD or N0107UD)</p> 	<p>2 AA Batteries</p> 	<p>Rod Antenna (Supplied with 13" model only)</p> <p>PART NO. (0EMN00673, 0EMN01599 or 0EMN01755)</p> 	<p>Owner's Manual</p>  <p>(1EMN20215)</p>
--	---	---	--

- If you need to replace these accessories, please refer to the PART NO. under the illustrations and call our help line mentioned on the front page.
- Depending on your antenna system, you may need different types of Combiners (Mixer) or Separators (Splitter). Contact your local electronics store for these items.
- We do not recommend the use of universal remote controls. Not all of the functions may be controlled with a universal remote control. If you decide to use a universal remote control with this unit, please be aware that the code number given may not operate this unit. In this case, please call the manufacturer of the universal remote control.

OPERATING CONTROLS AND FUNCTIONS

This manual covers 13" and 19". The operation of the two models are exactly the same except the appearance. 19" model is illustrated in this manual.

- TV/VCR FRONT PANEL -

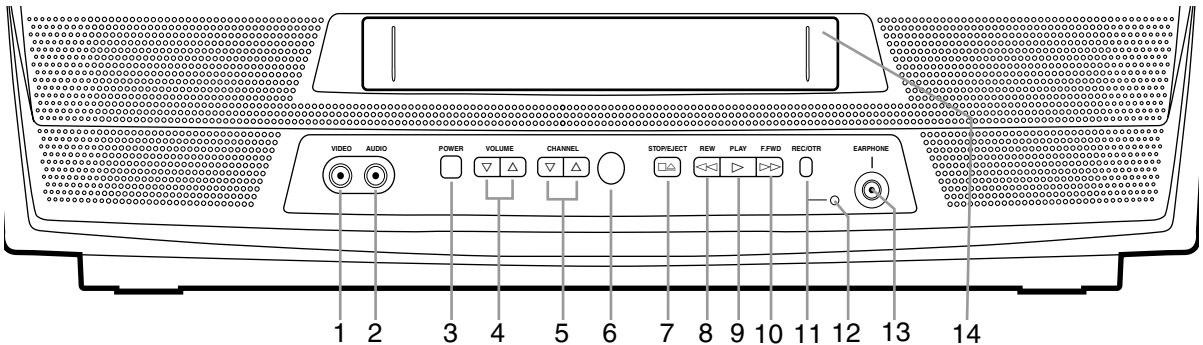

- REMOTE CONTROL -

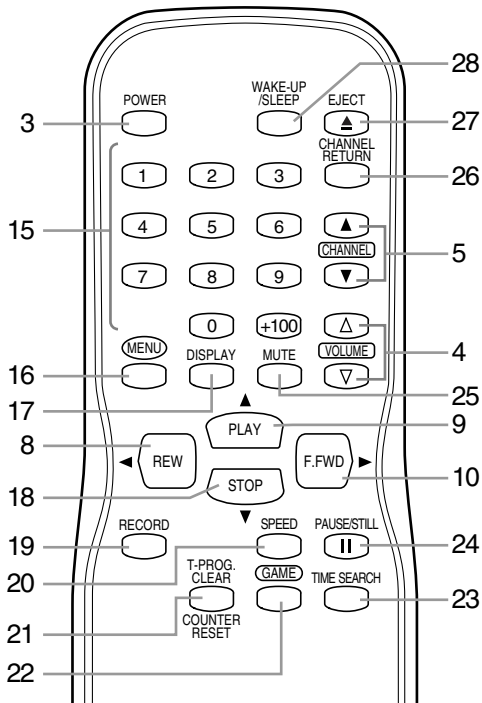

- 1 **VIDEO input jack**– Connect to the Video output jack of a video camera or VCR.
- 2 **AUDIO input jack**– Connect to the Audio output jack of an audio equipment, video camera or VCR.
- 3 **POWER button**– Hit to turn the unit on and off. Hit to activate timer recording.
- 4 **VOLUME Δ/∇ buttons**– Adjust the volume level.
- 5 **CHANNEL Δ/∇ buttons**– Press to select the desired channels for viewing or recording.
TRACKING function– Press to minimize video ‘noise’ (lines or dots on screen) during playback mode. (Refer to page 18.)
- 6 **Remote Sensor Window**– Receives the infrared signals from the remote control.

- 7 **STOP/EJECT \square/\triangle button**– Hit to stop the tape motion. Hit in the stop mode to remove the cassette from the unit.
- 8 **REW \lll button**– Hit to rewind the tape or to view the picture rapidly in reverse during playback mode. (Rewind Search)
 \blacktriangleleft button– (Remote control)
 - Hit to select a mode from the setting menu.
- 9 **PLAY \triangleright button**– Hit to start playback.
 \blacktriangle button– (Remote control)
 - Hit to select a mode or figure from the setting menu.
- 10 **F.FWD \ggg button**– Hit to rapidly advance the tape or to view the picture rapidly in forward during playback mode. (Forward Search)
 \blacktriangleright button– (Remote control)
 - Hit to determine your selection and proceed to the next step in the setting menu.
- 11 **REC/OTR button** – Hit to start manual recording. Hit repeatedly to start One Touch Recording (OTR).
- 12 **Record indicator**– Flashes during recording. Lights up in the stand-by mode for Timer Recording.
- 13 **EARPHONE jack**– Connects to earphones (not supplied) for personal listening. The size of jack is 1/8" (3.5mm) monaural.
- 14 **Cassette compartment**
- 15 **Number buttons**– Press to select desired channels for viewing or recording. To select a single-digit channel, hit [0] first and then [1] to [9].
+100 button– When selecting cable channels which are higher than 99, hit this button first, then press the last two digits. (To select channel 125, first hit [+100] button then hit [2] and [5].)
- 16 **MENU button**– Hit to enter or exit the setting menu.

- REAR VIEW -

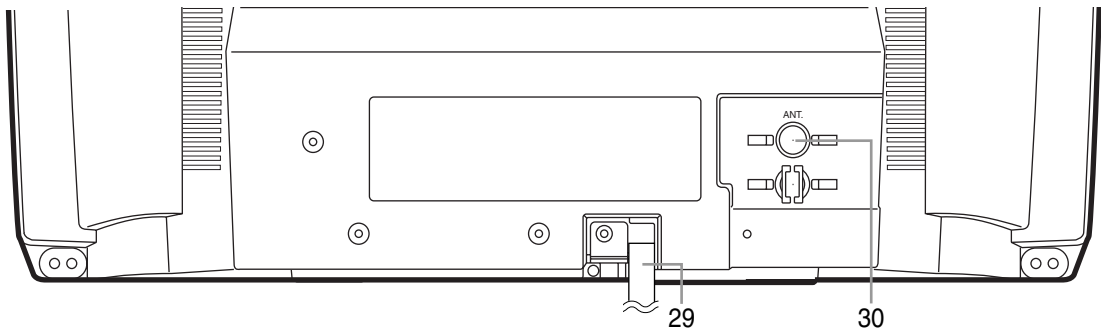

- 17 DISPLAY button**– Hit to display the counter or the current channel number and current time on the TV screen. (Refer to page 25.)
- 18 STOP button**– Hit to stop the tape motion.
- ▼ **button**– (Remote control)
- Hit to select a mode or figure from the setting menu.
- 19 RECORD button**– Hit to start manual recording.
- 20 SPEED button**– Hit to choose the desired recording speed:SP/SLP.
- 21 T-PROG. CLEAR button**– Hit to cancel a setting of timer program. (Refer to page 24.)
- COUNTER RESET button**– Hit to reset counter to 0:00:00.
- 22 GAME button**– Hit to set the Game mode and external input mode at the same time. (Refer to page 11.)
- 23 TIME SEARCH button**– Hit to activate Time Search mode.
- 24 PAUSE/STILL II button**– Hit to temporarily stop the tape during the recording or to view a still picture during playback.
- 25 MUTE button**– Hit to mute the sound. Hit it again to restore the sound.
- 26 CHANNEL RETURN button**– Hit to go back to the previously viewed channel. Hit again to return to the present channel.
- 27 EJECT ▲ button**– Hit in the stop mode to remove the cassette from the unit.
- 28 WAKE-UP/SLEEP button**– Sets the Wake up or Sleep Timer. (Refer to page 11 or 12.)
- 29 Power cord**– Connect to a standard AC outlet (120V/60Hz). (Refer to page 10.)
- 30 ANT(ENNA). jack**– Connect to an antenna, cable system or satellite system. (Refer to page 9.)

INSTALLING THE BATTERIES

- 1)Open the battery compartment cover by pressing the cover on the remote unit in the direction of the arrow.
- 2)Insert 2 “AA” penlight batteries into the battery compartment in the direction indicated by the polarity (+/-) markings.
- 3)Replace the cover.

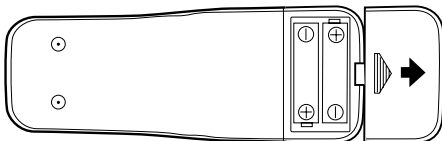

[BATTERY PRECAUTIONS]

- Be sure to follow the correct polarity as indicated in the battery compartment. Reversed batteries may cause damage to the device.
- Do not mix different types of batteries together (e.g. Alkaline and Carbon-Zinc) or old batteries with fresh ones.
- If the device is not to be used for a long period of time, remove the batteries to prevent damage or injury from possible battery leakage.
- Do not try to recharge batteries not intended to be recharged; they can overheat and rupture.

PREPARATION FOR USE

ANTENNA/CABLE CONNECTIONS

Plug the incoming cable into the ANT. jack on the rear of the unit.
If your cable service supplies you with a converter box or if you use a satellite system, connect the box with this unit as shown below.

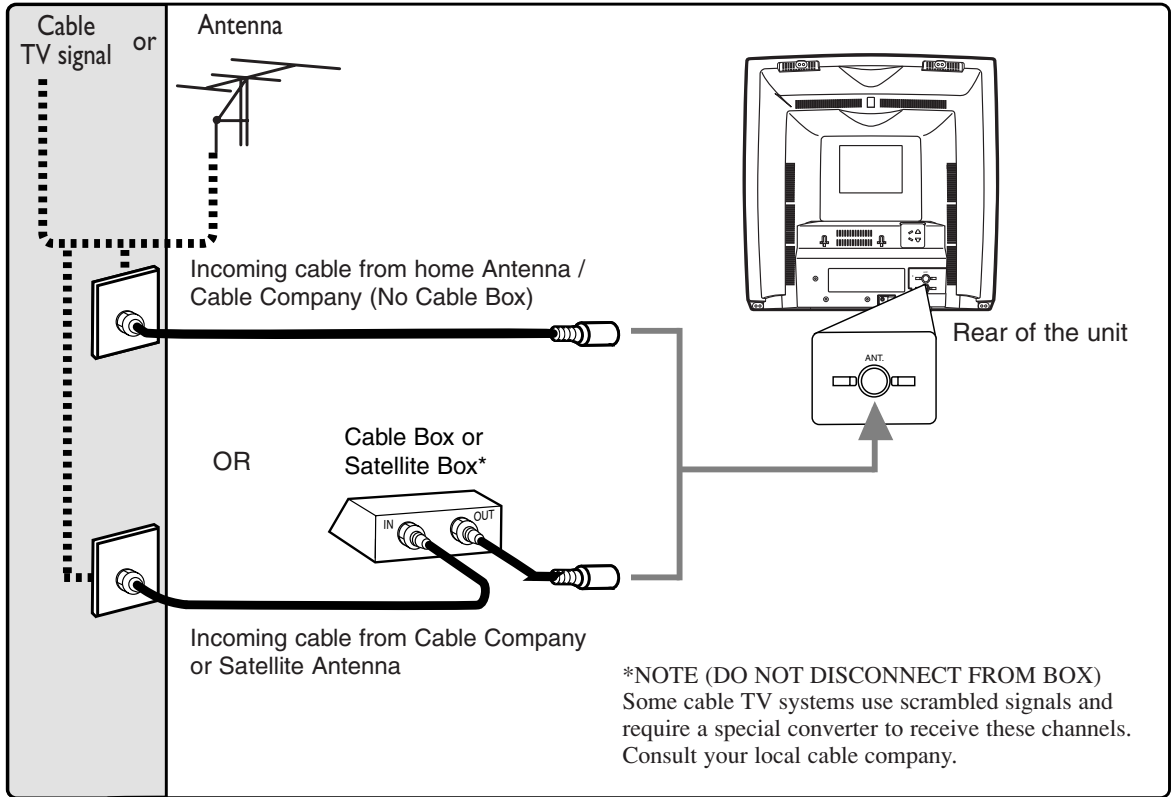

Note to CATV system installer:

This reminder is provided to call the CATV system installer's attention to Article 820-40 of the NEC that provides guidelines for proper grounding and in particular, specifies that the cable ground shall be connected to the grounding system of the building as close to the point of cable entry as practical.

NOTE:

Before plugging the antenna into the ANT. jack of the unit, check that the pin is not bent. If it is bent, straighten the pin as illustrated, then plug the pin into the ANT. jack of the unit.

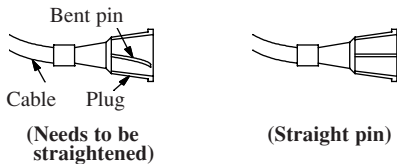

Rod Antenna Connection:

You can use the Rod Antenna (Supplied) if incoming cable is not available.

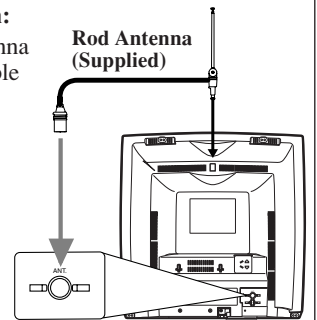

For your safety and to avoid damages to the unit, unplug the antenna cable from the ANT. jack before moving the unit.

USING FRONT A/V INPUT JACKS

When you watch a program recorded on another source (VCR or video camera), use the AUDIO/VIDEO input jacks on the front of the unit.

Connect the Audio/Video output jacks of another source to the AUDIO L/R and VIDEO jacks of this unit.

Then press [CHANNEL ▲/▼] until “AUX” appears on the screen.

AUX

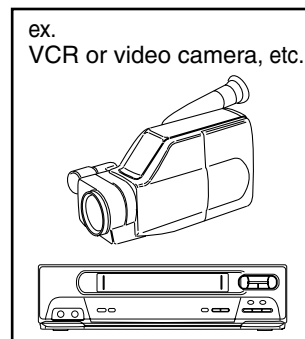
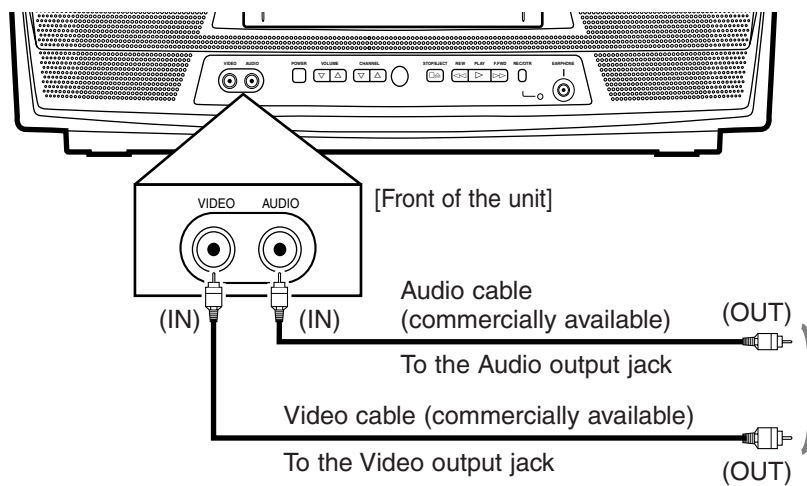

TV OPERATION AND SETTINGS

WATCHING A TV PROGRAM

1 Plug in the unit power cord

Plug the unit power cord into a standard AC outlet.

NOTE:

- If any digits appear in the corner of the screen, hit [POWER] without unplugging the power cord.

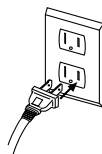

2 Turn on the unit

Hit [POWER] to turn on the unit.

3 Select the channel number

Press [CHANNEL ▲/▼] or the **Number buttons** to select your desired channel number.

Note for using the Number buttons:

- You must precede single-digit channel numbers with a zero (for example: 02, 03, 04 and so on).
- When selecting cable channels which are higher than 99, hit [+100] first, then press the last two digits. (Example: to select channel 125, first hit [+100] then hit [2] and [5].)

4 Adjust sound

Press [VOLUME ▲/▼] to adjust the volume.

Hit [MUTE] to instantly mute the sound.

Hit it again to restore the previous sound level.

VOLUME 20

TO WATCH CABLE OR SATELLITE CHANNEL

- If the unit is connected to a cable box or satellite box, press [CHANNEL ▲/▼] to select CH3 or CH4 according to the output channel setting of the device and select desired channel on that device.

TO WATCH EXTERNAL INPUT

- When an external equipment is connected to the front AUDIO/VIDEO input jacks, **press [CHANNEL ▲/▼] repeatedly until “AUX” appears on the screen.**

SLEEP TIMER

The Sleep Timer function turns off the unit without using [POWER] after a desired period of time.

NOTE:

- This function does not work during Recording mode.

1 Call up "SLEEP TIMER" setting

Hit [WAKE-UP/SLEEP] repeatedly so that "SLEEP TIMER" appears.

2 Set sleep time

Press [PLAY/▲], [STOP/▼], [REW/◀] or [F.FWD/▶] until your desired sleep time appears. Each additional pressing will increase the time by 30 minutes up to 120.

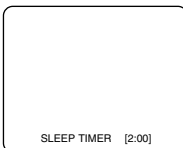

Hit [MENU] to exit the Sleep Timer setting.

TO CANCEL THE SLEEP TIMER

Hit [WAKE-UP/SLEEP] until "SLEEP TIMER" appears.

Press [PLAY/▲], [STOP/▼], [REW/◀] or [F.FWD/▶] until [OFF] appears.

CLOSED CAPTION SYSTEM

You can view specially labeled (cc) TV programs, movies, news and pre-recorded tapes with either a dialogue caption or text display.

CAPTION mode: You can watch dramas, movies and news while captioning the dialogues and the contents of news.

TEXT mode: You can watch half screen text information if you want.

1-2: You may get these captions or text information by selecting either "1" or "2". Caption "2" is usually used for a second language if available.

NOTES:

- Not all programs are broadcast with closed captions. Your unit is designed to provide error free closed captions from high quality antenna, cable and VCR signals. Conversely, poor quality signals are likely to result in caption errors or no captions at all. Common signal conditions which may cause caption errors are listed below:
 - Automobile ignition noise
 - Electric motor brush noise
 - Weak snowy reception on TV screen
 - Multiplex signal reception displaying picture ghosts or airplane flutter.
 - Playback of poorly recorded or worn VCR tapes.
- If the unit displays a black box on the TV screen, this means that the unit is set to the TEXT mode. To clear screen, select [CAPTION1], [CAPTION2] or [OFF].



Make sure ...

- The unit must be turned on.

1 Select "CAPTION"

Hit [MENU].

Press [PLAY/▲] or [STOP/▼] to point to "CAPTION".

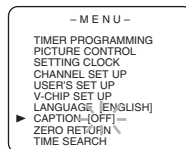

2 Select your desired caption menu

Press [REW/◀] or [F.FWD/▶] until your desired caption menu appears.

([CAPTION1], [CAPTION2], [TEXT1] or [TEXT2])



3 Exit the caption setting mode

Hit [MENU] to return to TV mode.

NOTE:

- Even if there is a power failure of any kind, the unit will retain its memory for this feature.

TO CANCEL THE CLOSED CAPTION SYSTEM

Repeat steps 1 to 2 and select [OFF] using [REW/◀] or [F.FWD/▶]. Then hit [MENU] to return to TV mode.

CHANNEL SET UP

Make sure ...

- The unit must be turned on.

AUTO CHANNEL PROGRAMMING

As the initial setting, this unit has memorized all channels, including the ones not available in your area. This feature automatically puts only available channels into the memory.

1 Select "CHANNEL SET UP"

Hit [MENU].

Press [PLAY/▲] or [STOP/▼] to point to "CHANNEL SET UP", then hit [F.FWD/▶].

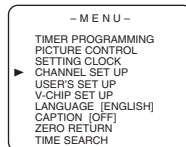

2 Begin channel scanning

Press [PLAY/▲] or [STOP/▼] to point to "AUTO CH PROGRAMMING", then hit [F.FWD/▶].

The tuner scans and memorizes all the active channels in your area.

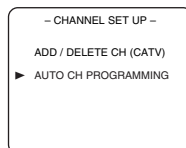

3 After scanning

The tuner stops on the lowest memorized channel.

NOTES:

- If there is no TV signal input, “NO TV SIGNALS” will appear on the display after the completion of channel scanning.
- The unit may recognize TV channels to be CATV channels if reception condition is poor. In this case, check the antenna connection and try “AUTO CH PROGRAMMING” again when reception conditions are better.
- **Channel memory programming is NOT necessary when connected to a cable box or satellite box. Just select the channel for the cable box or satellite input (ex. CH3) on the unit, then select your desired channel on the cable box or satellite box.**

ADDING/DELETING CHANNELS

The channels you no longer receive or seldom watch can be deleted from the memory. (Of course, you can add the deleted channel into the memory again.)

1 Select “CHANNEL SET UP”

Hit [MENU].

Press [PLAY/▲] or [STOP/▼] to point to “CHANNEL SET UP”, then hit [F.FWD/▶].

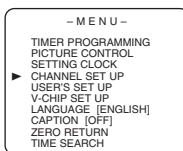

2 Select “ADD/DELETE CH”

Press [PLAY/▲] or [STOP/▼] to point to “ADD/DELETE CH”, then hit [F.FWD/▶].

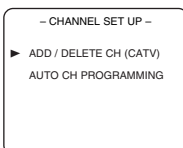

3 Enter the desired channel number

Press [PLAY/▲] or [STOP/▼] or the **Number** buttons until your desired channel number appears. (You can also press [CHANNEL ▲/▼] to enter it.)

- You must precede single-digit channel numbers with a zero (Example: 02 ... 09).
- When selecting cable channels which are higher than 99, hit [+100] first, then press the last two digits. (Example: to select channel 125, first hit [+100] then hit [2] and [5].)

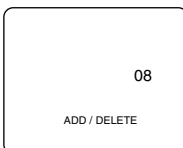

4 Delete (or add) it from (or into) memory

Press [REW/◀] or [F.FWD/▶]. The channel number changes to light red. The channel is deleted from memory.

- To delete another channel, repeat steps 3 to 4.
- If you press [REW/◀] or [F.FWD/▶] again, the channel is memorized again.

Added channel: Light blue
Deleted channel: Light red

5 Exit the channel setup mode

Hit [MENU] to returns to TV mode.

NOTE:

- To confirm that channel(s) has been deleted or added, press [CHANNEL ▲/▼].

CLOCK SET UP (AUTO / MANUAL)

The unit clock must be set correctly so that VCR timer recording is possible. It is suggested that the clock be set manually when first setting up the unit, then set to [ON] the auto clock setting which will periodically correct the setting if necessary.

NOTE:

- If you cannot receive a station with time signals, auto clock setting cannot be performed. Use manual setting only.

MANUAL CLOCK SETTING

Make sure ...

- The unit must be turned on.

In the example below, the clock is to be set to:

DATE May 5th, 2005
SETTING TIME 5:40PM

1 Select “SETTING CLOCK”

Hit [MENU].

Press [PLAY/▲] or [STOP/▼] to point to “SETTING CLOCK”, then hit [F.FWD/▶].

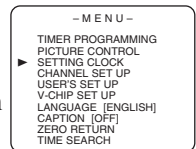

2 Select “MANUAL CLOCK SET”

Press [PLAY/▲] or [STOP/▼] to point to “MANUAL CLOCK SET”, then hit [F.FWD/▶].

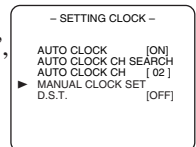

3 Select the month

Press [PLAY/▲] or [STOP/▼] until your desired month appears. (Example: May → “05”) Then hit [F.FWD/▶].

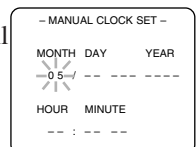

4 Select the day

Press [PLAY/▲] or [STOP/▼] until your desired day appears. (Example: 5th → “05”) Then hit [F.FWD/▶].

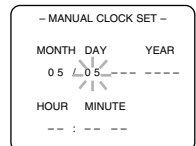

5 Select the year

Press [PLAY/▲] or [STOP/▼] until your desired year appears. (Example: “2005”) Then hit [F.FWD/▶].

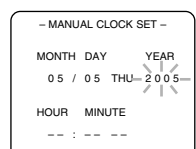

6 Select the hour

Press [PLAY/▲] or [STOP/▼] until your desired hour appears. (Example: “5”, “PM”) Then hit [F.FWD/▶].

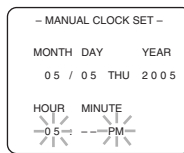

7 Select the minute

Press [PLAY/▲] or [STOP/▼] until the desired minute appears. (Example: “40”)

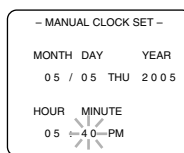

8 Start the clock

Hit [MENU].

Although seconds are not displayed, they begin counting from 00 when you hit [MENU]. Use this feature to synchronize the clock with the correct time.

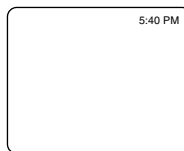

NOTE:

- When unplugging the AC cord or if there is a power failure for more than 3 seconds, you may have to reset the clock.

TO CHANGE CLOCK SETTING

If you want to change the clock,

- 1) Follow steps **1** to **2** on page 13.
- 2) Select the item you want to change using [REW/◀] or [F.FWD/▶].
- 3) Enter correct numbers using [PLAY/▲] or [STOP/▼].

4) Hit [MENU] to start the clock.

NOTE:

- If there is no local PBS station in your area or on your cable system, select “AUTO CLOCK” and press [REW/◀] or [F.FWD/▶] to turn [OFF] this function. Then you can manually adjust the clock.

AUTOMATIC CLOCK SETTING

Make sure ...

- The unit must be turned on.
- Confirm the unit is receiving a RF (Radio Frequency) signal from either an antenna or cable system connection using the ANT. jack on the rear of the unit.

NOTES:

- If a cable converter box is being used, make sure it is powered on.
- You must use the remote control to perform the clock setting procedure.
- If the unit is connected directly to a cable converter box or satellite box, the local PBS station must be selected on the cable box itself and the unit must be set to the output channel of the cable converter box or satellite box (usually channel 3 or 4), to be able to set up or correct the clock automatically.

1 Select “SETTING CLOCK”

Hit [MENU].

Press [PLAY/▲] or [STOP/▼] to select “SETTING CLOCK”, then hit [F.FWD/▶].



2 Set “AUTO CLOCK” to [ON]

Hit [F.FWD/▶] until “AUTO CLOCK [ON]” appears.

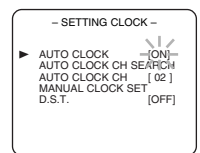

3 Begin “AUTO CLOCK CH SEARCH”

Hit [STOP/▼] to select “AUTO CLOCK CH SEARCH”.

Then hit [F.FWD/▶].

- The unit begins searching for the station which contains the auto clock set signal. The search for a signal may take up to 20 seconds per channel.
- When the search has ended, “_ _” appears at the lower left of the screen.
- Write down the number(s) that appear on the screen. They are the auto clock station(s) in your area.
- If no number(s) appear on the TV screen, there are no stations in your area which contain the Auto Clock signal. Auto Clock Setting is not possible. Please use Manual Clock Setting on page 13. Hit [MENU] to exit the screen.

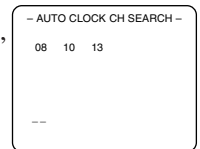
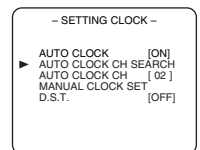

NOTE:

- During AUTO CLOCK CH SEARCH, the picture may be distorted.

4 Enter the channel number that contains the Automatic Clock Setting Signal

Follow step **1** above to select “SETTING CLOCK” menu.

Hit [STOP/▼] to select “AUTO CLOCK CH”.

Press [REW/◀] or [F.FWD/▶] until you locate Auto Clock Set station number that you wrote down at step **3**. Hit [MENU] to exit the screen.

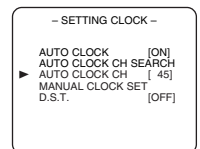

5 Turn off the unit

Once the unit is turned off, it will periodically check and set the correct date and time.

DAYLIGHT-SAVING TIME

When Daylight-Saving Time is ON, the clock will change automatically as follows:

- **First Sunday of April** : At 2 AM the clock immediately changes to 3 AM. Any timer programming you have set to occur between 2 AM and 3 AM will not record.
- **Last Sunday of October** : At 2 AM the clock immediately changes to 1 AM.

Make sure ...

- The unit must be turned on.

1 Select "SETTING CLOCK"

Hit [MENU].

Press [PLAY/▲] or [STOP/▼] to point to "SETTING CLOCK", then hit [F.FWD/▶].

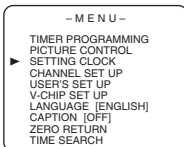

2 Set "D.S.T." (Daylight-Saving Time) to [ON]

Press [PLAY/▲] or [STOP/▼] to point to "D.S.T.", then press [REW/◀] or [F.FWD/▶] until "ON" appears.

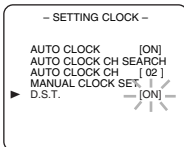

3 Exit the Daylight-Saving Time mode

Hit [MENU] to return to TV mode.

TO CANCEL THE DAYLIGHT-SAVING TIME

Repeat steps 1 to 2 and select [OFF] using [REW/◀] or [F.FWD/▶].

MENU LANGUAGE

1 Select "LANGUAGE"

Hit [MENU].

Press [PLAY/▲] or [STOP/▼] to point to "LANGUAGE".

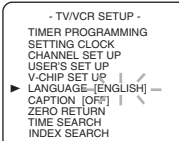

2 Select "ENGLISH", "ESPAÑOL" or "FRANÇAIS"

Press [REW/◀] or [F.FWD/▶] repeatedly to select "ENGLISH", "ESPAÑOL"= Spanish or "FRANÇAIS"= French.

3 Exit the Language mode

Hit [MENU] to turn to TV mode.

NOTES:

- This function effects only the language on the screen menu and not the audio source.
- If for some reason the menu is in Spanish or French, hit [MENU], press [PLAY/▲] or [STOP/▼] to point to "IDIOMA [ESPAÑOL]" or "LANGAGE [FRANÇAIS]", then hit [F.FWD/▶] repeatedly to select desired language, then hit [MENU].

V-CHIP SET UP

This feature enables parents to prevent their children from watching inappropriate material on TV. When you try to access a program which is blocked, "PROTECTED PROGRAM by ..." message appears on the TV screen.

V-CHIP SET UP

Make sure ...

- The unit must be turned on.

1 Select "V-CHIP SET UP"

Hit [MENU].

Press [PLAY/▲] or [STOP/▼] to select "V-CHIP SET UP", then hit [F.FWD/▶].

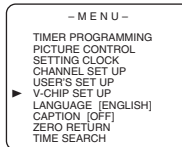

2 Select the desired item

Press [PLAY/▲] or [STOP/▼] to select "TV RATING" or "MPAA RATING", then hit [F.FWD/▶].

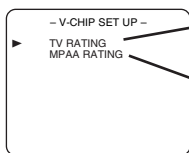

A Step 3

B Step 3

A TV RATING SET UP

Follow steps 1 to 2 in the "V-CHIP SET UP" section above.

3 Blocking TV programs

Press [PLAY/▲] or [STOP/▼] to select a rating that you wish to block.

Hit [F.FWD/▶] repeatedly to set it to [BLOCK] or [VIEW].

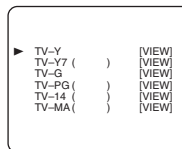

Selection	Rating Category Explanations
TV-Y	Appropriate for all children
TV-Y7	Appropriate for children seven and older
TV-G	General Audience
TV-PG	Parental Guidance suggested.
TV-14	Unsuitable for children under 14
TV-MA	Mature audience only

NOTE:

- When you select a rating and set it to [BLOCK], the higher ratings will be blocked automatically. The lower ratings will be available for viewing.
- When you set the lowest rating to [VIEW], all other ratings will automatically be available for viewing.

4 Setting "Sub-Ratings"

When you select the ratings of TV-Y7, TV-PG, TV-14 or TV-MA you will have the option of setting sub rating categories.

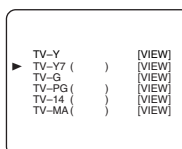

Press [PLAY/▲] or [STOP/▼] to select a rating with sub-ratings you wish to block, then hit [F.FWD/▶] twice.

Press [PLAY/▲] or [STOP/▼] to select a sub-rating, then hit [F.FWD/▶] to set it to [BLOCK] or [VIEW].

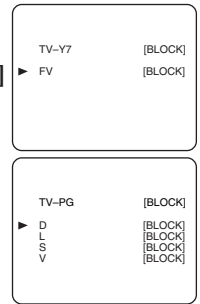

Selection	Rating Category Explanations
TV-Y7	
FV	Fantasy Violence
TV-PG, TV-14, TV-MA	
D	Suggestive Dialog (TV-PG, TV-14 only)
L	Coarse Language
S	Sexual Situation
V	Violence

NOTE:

- The blocked sub-ratings will appear next to the rating category in the "TV RATING" menu.

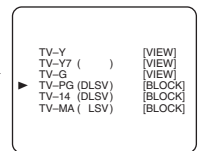

5 Exit the V-Chip setting mode

Press [MENU] to return to original mode.

NOTE:

- To change the rating, the TV must be turned to an unprotected program. If "PROTECTED PROGRAM by ..." appears on the screen, please change the channel to a station that is not protected.

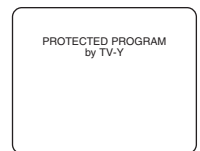

B MPAA RATING SET UP

Follow steps 1 to 2 in the "V-CHIP SET UP".

3 Select your desired item

Press [PLAY/▲] or [STOP/▼] to point to your desired item, then hit [F.FWD/▶] to select [BLOCK] or [VIEW].

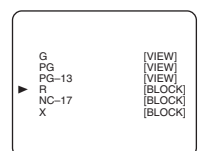

Selection	Rating Category Explanations
G	General Audience
PG	Parental Guidance suggested.
PG-13	Unsuitable for children under 13
R	Restricted; under 17 requires accompanying parent or adult guardian
NC-17	No one under 17 admitted
X	Mature audience only

- When you select a rating and set it to [BLOCK], the higher ratings will be blocked automatically. The lower ratings will be available for viewing.
- When you set the lowest rating to [VIEW], all other ratings will automatically be available for viewing.

4 Exit the V-Chip setting mode

Hit [MENU] to return to original mode.

VIDEO CASSETTE

This unit will operate with any cassette that has the **VHS** mark. For best results, we recommend the use of high-quality tapes. Do not use poor quality or damaged tapes.

PRECAUTIONS

- Avoid moisture. Moisture condensation may occur on the tape if it is moved from a cold place to a warm place or vice versa. Before using a tape with these conditions, to avoid damage of the tape and your unit, wait until the tape has warmed to room temperature and the moisture has evaporated.
- Avoid extreme heat, high humidity and magnetic fields.
- Do not tamper with the cassette mechanism.
- Do not touch the tape with your fingers.

TWO DIFFERENT TAPE SPEEDS

Before recording, select the tape speed from : **SP mode** (Standard Play) or **SLP mode** (Super Long Play).

The table below shows the maximum recording/playback time using T60, T120 or T160 tapes in each mode.

Tape Speed	Recording/Playback Time			
	Type of tape	T60	T120	T160
SP mode		1 hour	2 hours	2-2/3 hours
SLP mode		3 hours	6 hours	8 hours

NOTE:

- You can play back a tape recorded in LP mode (Long Play).

INSERTING A CASSETTE

Insert the cassette in the direction as shown. Push in gently, but continuously, on the center-back of the cassette until it is drawn into the unit. The unit will automatically turn on.

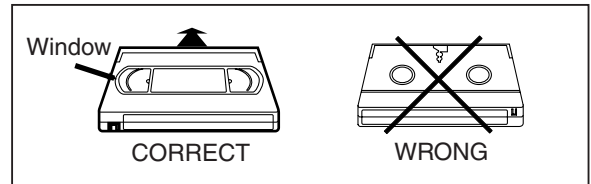

REMOVING A CASSETTE

- 1) In the stop mode, hit [STOP/EJECT □ ▲] on the unit. The cassette will be ejected.
- 2) Pull the cassette out of the cassette compartment.
- 3) Store the cassette in its case as shown.

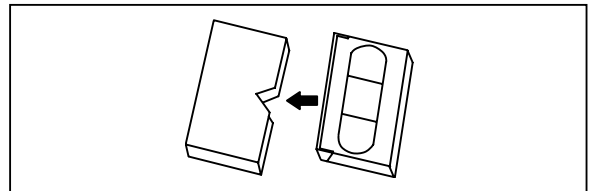

ERASE PREVENTION

You can prevent accidental erasing of recording by breaking off the tab on the back edge of the cassette.

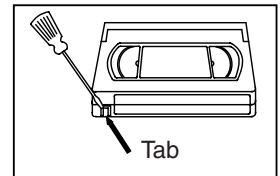

If you decide to record on the tape again, cover the hole with plastic tape.

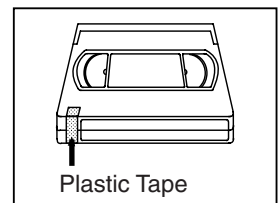

NOTE:

- If the cassette without tab is inserted, playback will automatically start.

PLAYBACK

NORMAL PLAYBACK

Make sure ...

- The unit must be turned on.

1 Insert a prerecorded tape

If the erase-prevention tab has been removed, the unit will start playback automatically.

2 To begin playback

Hit [PLAY/▲].

NOTE:

- If any menu is activated on the screen, [PLAY/▲] does not function. Hit [MENU] to exit the menu. Then, hit [PLAY/▲].



3 To stop playback

Hit [STOP/▼].



TRACKING ADJUSTMENT

- Tracking adjustment will be set automatically (Digital Auto Tracking function) when you start playback.
- Noise lines (black and white streaks) may appear on the playback picture when playing pre-recorded tapes or tapes recorded on other VCR. If this occurs, press [CHANNEL ▲/▼] until the streaks disappear. To return to the Digital Auto Tracking function, stop the tape once and start playback.

STILL PICTURE

You can view a still picture on the TV screen during playback (the Still mode). Hit [PAUSE/STILL ■■] during playback. Only tapes recorded in the SLP mode will show the least amount of lines. Hit [PLAY/▲] to return to playback.

NOTES:

- Usually there will be video “noise” lines (black and white streaks or dots) on the screen. This is normal.
If the tape was originally recorded in SP or LP mode, the still picture will be black and white in addition to the “noise” lines.
This is not a fault of the machine, but is a by-product of the technology involved in producing a unit with 2 video heads.
- If the unit is left in the Pause mode for more than 5 minutes, the unit will automatically switch to the stop mode.

NOISE CANCEL (in the Still mode)

This feature allows you to reposition or reduce the noise lines of a still picture. Hit [PAUSE/STILL ■■] so that the noise lines change position on the screen so you can see the picture in its entirety without distracting noise lines.

NOTE:

- This feature can be activated ONLY when viewing a tape recorded in the SLP mode. If the tape was originally recorded in the SP or LP mode, the still picture may revert to black and white in addition to the “noise bars”. This is normal.

VERTICAL HOLD CONTROL

In the Pause/Still mode only, when the picture begins to vibrate vertically, stabilize the picture by pressing [CHANNEL ▲/▼].

NOTE:

- If there are video noise lines on the screen, reposition or reduce them. Refer to “NOISE CANCEL” above.

SPECIAL PLAYBACK

Make sure ...

- The unit must be turned on.
- Insert a prerecorded tape.

RENTAL PLAYBACK

This function enables you to improve the picture quality when playing back worn cassettes such as rented tapes.

1 Select "USER'S SET UP"

Hit [MENU].

Press [PLAY/▲] or [STOP/▼] to point to "USER'S SET UP", then hit [F.FWD/▶].

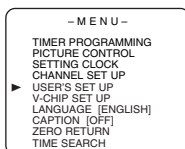

2 Set "RENTAL" to [ON]

Press [PLAY/▲] or [STOP/▼] to point to "RENTAL".

Press [F.FWD/▶] or [REW/◀] until [ON] appears.

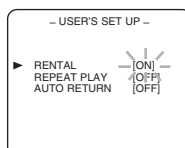

3 Exit the Rental setting

Hit [MENU] to return to the TV mode.

4 Start playback

Hit [PLAY/▲] to start playback.

"RENTAL PLAY ▶" appears.

- Once you select the Rental mode, it stays in effect even after you turn off the unit.

TO CANCEL THE RENTAL MODE

Repeat steps 1 to 2 and select [OFF] using [REW/◀] or [F.FWD/▶]. Hit [MENU] to return to TV mode.

Even if there is a power failure of any kind, the unit will retain its memory for this feature.

AUTO REPEAT PLAYBACK

The unit has the auto repeat function that allows you to repeat a tape indefinitely without hitting [PLAY/▲].

ALL REPEAT: Repeat playback from the beginning to the end of the tape.

BLANK REPEAT: Repeat playback from the beginning to a blank part, which is blank for more than 10 seconds.

1 Select "USER'S SET UP"

Hit [MENU].

Press [PLAY/▲] or [STOP/▼] to point to "USER'S SET UP", then hit [F.FWD/▶].

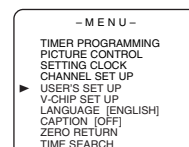

2 Select "ALL" or "BLANK"

Press [PLAY/▲] or [STOP/▼] to point to "REPEAT PLAY".

Press [REW/◀] or [F.FWD/▶] repeatedly until your desired selection [ALL] or [BLANK] appears.

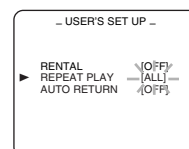

3 Exit the Repeat Play setting

Hit [MENU] to return to the TV mode.

4 Start playback

Hit [PLAY/▲] to start the Repeat Play.

"REPEAT PLAY ▶" appears.

- Once you select the Repeat Play mode, it stays in effect even after you turn off the unit.
- If the Rental mode is set [ON], the "RENTAL PLAY ▶" display has priority.

TO CANCEL THE REPEAT PLAY MODE

Repeat steps 1 to 2 and select [OFF] using [REW/◀] or [F.FWD/▶]. Hit [MENU] to return to TV mode.

Even if there is a power failure of any kind, the unit will retain its memory for this feature.

SEARCH

Make sure ...

- The unit must be turned on.
- Insert a tape.

ZERO RETURN

This function allows you to search easily a beginning point that you want to review by rewinding or fast forwarding.

NOTE:

- Zero Return **WILL NOT** work on a blank tape or a blank portion of a tape.

1 Stop a tape at your desired point

Rewind or fast forward the tape to the beginning point at which you want to review.

2 Reset the counter to 0:00:00

Hit [COUNTER RESET] repeatedly.

3 Begin recording or playback

Press [RECORD] or [PLAY/▲].

Hit [STOP/▼] when recording or playback is completed.

4 To activate "ZERO RETURN" mode

Hit [MENU].

Press [PLAY/▲] or [STOP/▼] to point to "ZERO RETURN", then hit [F.FWD/▶].

The counter will appear on the TV screen.

The tape will automatically stop when the counter returns to 0:00:00. (approx.)

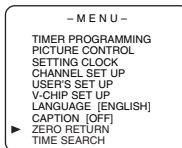

PICTURE SEARCH

This feature is very useful in finding or skipping over a particular scene on a tape. In this mode, the sound will be muted.

1 Start Picture Search

During playback, press [REW/◀] or [F.FWD/▶] to view at a high speed (in forward/reverse).

2 Change searching speed

Press [REW/◀] or [F.FWD/▶] again to view at super high speed (in the LP/SLP modes only).

NOTE:

- Tapes recorded in the SP or LP mode will normally display a noise bar on the TV screen and the picture may revert to Black and White.

3 Return to normal speed

Hit [PLAY/▲].

TIME SEARCH

The Time Search function makes it possible to quickly advance the tape to your desired position simply by entering the exact amount of playback time you want to skip.

NOTES:

- Time Search can be set up to a maximum of 9 hours 50 minutes (9:50) by 10 minutes at a time.

In the example below: To watch a program before/after 2 hour 50 minutes from the present position, in either direction.

1 Call up "TIME SEARCH" setting

Hit [TIME SEARCH].

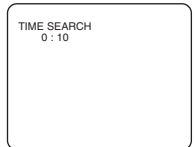

2 Enter your desired time

Press [PLAY/▲] or [STOP/▼] until your desired time appears. (Example: "2:50" stands for 2 hours 50 minutes) You can also use [TIME SEARCH].

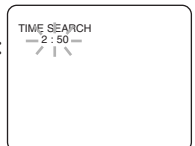

If you wish to cancel the Time Search at this point, hit [MENU].

3 Begin Time Search

By pressing [REW/◀] or [F.FWD/▶], the unit will rewind or fast forward to the specified point.

The time counts down during the search. When the display shows "0:00", the tape will start playback automatically.

TO CANCEL DURING TIME SEARCH

Press [STOP/EJECT □ ▲] on the unit or [STOP/▼]. This will delete the selected time.

SPECIAL FEATURES

REAL TIME TAPE COUNTER

This shows the elapsed recording or playback time in hours, minutes, and seconds. (The displayed time will not change on a blank tape or blank portions on the tape.) The “-” indication will appear when the tape has rewound further than “0:00:00” on the tape counter.

AUTO REWIND-EJECT

- When the end of a tape is reached during recording, playback or fast-forward, the tape will automatically rewind to the beginning. After rewinding finishes, the unit will eject the tape and turn itself off.
- This function is operative when Repeat Play is set to [OFF].
- The tape will not auto-rewind during timer recording or One Touch Recording.

RECORDING

Make sure ...

- The unit must be turned on.
- Insert a cassette tape with its erase-prevention tab in place. (If necessary, rewind or fast forward the tape to the point at which you want to begin recording.)

NOTE:

- This unit will ONLY record and view the same channel.

NORMAL RECORDING

You can ONLY watch the same TV program that is being recorded.

1 Select the channel to be recorded

Press the **Number buttons** or **[CHANNEL ▲/▼]**.

NOTE:

- If the unit is connected to a cable box or satellite box, the unit must be on CH3 or CH4, then the channel to be recorded must be selected on the cable box or satellite box.

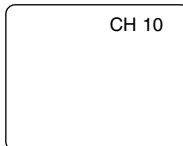

SKIPPING UNWANTED SCENES DURING RECORDING

Hit **[PAUSE/STILL II]** to temporarily stop recording. Press **[PAUSE/STILL II]** or **[RECORD]** to resume recording.

NOTES:

- After 5 minutes, the unit will automatically switch to the Recording mode to prevent tape damage.
- If Closed Caption mode is on, the On-Screen Display will appear for 5 seconds, then disappear.

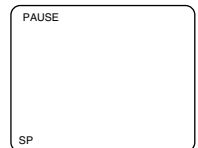

2 Select the tape speed

Hit **[SPEED]** to select the desired tape speed (SP/SLP).



3 Begin recording

Hit **[RECORD]**.

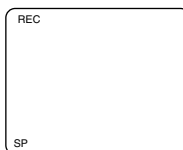

4 Stop recording

Hit **[STOP/▼]**.

OTR (One Touch Recording)

This function enables you to set a recording length simply by hitting [REC/OTR] on the unit.

Make sure ...

- The unit must be turned on.
- Insert a cassette tape with its erase-prevention tab in place. (If necessary, rewind or fast forward the tape to the point at which you want to begin recording.)

NOTES:

- You **cannot** start OTR with the remote control.
- Recording starts immediately when [REC/OTR] is hit.
- When [REC/OTR] is hit 18 times, the unit returns to the Normal Recording mode.
- To stop the OTR operation, hit [STOP/EJECT □ △] on the unit or on the remote control.
- To show the remaining time, hit [DISPLAY] on the remote control so that "OTR" appears on the TV screen. (It will show up momentarily then disappear.)
- Recording stops when the display shows 0:00.
- Please note that in the SLP mode maximum recording time, assuming the tape is started at the beginning, is 8 hours using T-160 (or 6 hours using T-120).
- If the tape runs out before the end time, the unit will switch to the stop mode immediately, ejects the tape and turns itself off.
- Even if [POWER] is hit during OTR, the unit continues recording.

1 Select the channel to be recorded

Press the **Number buttons** or [CHANNEL ▲/▼].

NOTE:

- If the unit is connected to a cable box or satellite box, the unit must be on CH3 or CH4, then the channel to be recorded is selected on the cable box or satellite box.

2 Select the tape speed

Hit [SPEED] to select the desired tape speed (SP/SLP).

3 Begin OTR

Hit [REC/OTR] on the unit as many times as needed. The recording length will be determined by the number of times you hit [REC/OTR]. Each time it is hit, the recording time will be increased by 30 minutes up to 8 hours.

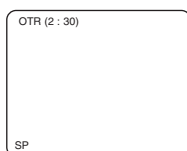

Time(s)	Display	Recording length
1 time		(normal recording)
2 times	0:30	30 minutes
3 times	1:00	60 minutes
↓	↓	↓
17 times	8:00	480 minutes

COPYING A VIDEO CASSETTE (Requires a VCR or camcorder)

You can make copies of video tapes made by friends or relatives for your enjoyment.

WARNING: Unauthorized recordings of copyrighted video tapes may be an infringement of copyright laws.

Connect your unit and a source (playing) VCR using the following diagram.

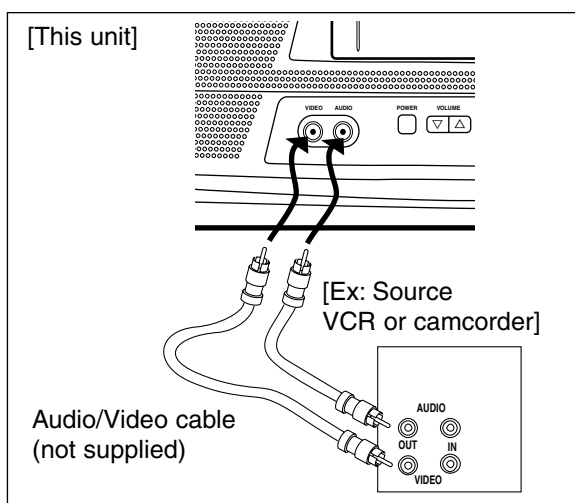

- 1) Insert a pre-recorded video cassette into the source VCR or camcorder.
- 2) Insert a blank video cassette or one you want to record over, into the unit's cassette compartment.
- 3) Hit [SPEED] on remote control for the unit to select the desired recording speed (SP/SLP).
- 4) Press [CHANNEL ▲/▼] on the unit until "AUX" appears on the screen.
- 5) Hit [REC/OTR] on the unit.

- 6) Begin playback of the tape in the source VCR or camcorder.

NOTE:

- For best results during copying, use the front panel controls whenever possible. The remote control might affect the source VCR's playback operation.
- 7) To stop copying, hit [STOP/EJECT □ △] on the unit, then stop the tape on the source VCR or camcorder.

TIMER RECORDING

AUTOMATIC TIMER RECORDING

You may set the unit to start and end a recording while you are away. You can set 8 programs to record on specific days, daily or weekly within a 1 year period.

In the example below, the timer is being set to record:

DATE: July 4th, 2005
 SETTING TIME: from 7:30PM to 8:50PM
 CHANNEL: CH61
 TAPE SPEED: SP

Make sure ...

- If a cable box or satellite box is connected with the unit you will be limited to record only one channel, and the channel selector on the unit must be selected to the output channel of the boxes CH 3 or CH 4 and then the actual channel to be recorded must be selected on the boxes.
- Clock must be set to the correct time and date before setting the timer.
- The unit must be turned on to program it.
- Insert a cassette tape with its erase-prevention tab in place. (If necessary, rewind or fast forward the tape to the point at which you want to begin recording.)
- The channel you want to record is properly set in advance. (Refer to page 12.)

Avoid overlap of programs ...

There is a chance that a program will not be recorded, when programs overlap;

- The program with an earlier start has priority.
- Once the earliest program finishes, the overlapping programs will begin recording in sequence.
- When the starting time is the same, the program set on the highest position in the program list has priority.
- The illustration below demonstrates the sequence of recordings.

Program 1 10:00AM - 11:00AM
 Program 2 9:00AM - 10:00AM
 Program 3 9:30AM - 12:00PM

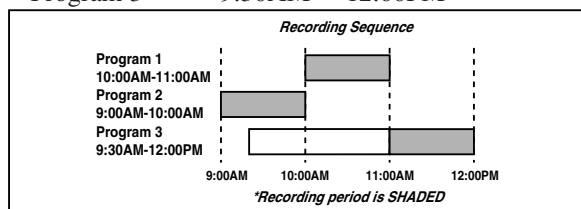

1 Select "TIMER PROGRAMMING"

Hit [MENU].

Confirm "TIMER PROGRAMMING" is pointed by hitting [PLAY/▲], then hit [F.FWD/▶].

- If you have not yet set the clock, "MANUAL CLOCK SET" appears. If so, follow steps 3 to 8 on page 13 and 14. Then set the timer recording.

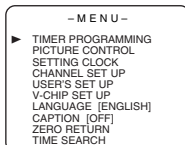

2 Select your desired program position (1 to 8)

Press [PLAY/▲] or [STOP/▼] to select the desired program position, then hit [F.FWD/▶].

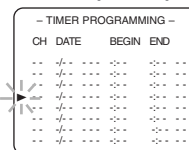

3 Set the channel number

Press [PLAY/▲] or [STOP/▼] until the desired channel number appears (Example: CH61), then hit [F.FWD/▶].

NOTE:

- If the unit is connected to a cable box or satellite box, the unit must be on CH3 or CH4, then the channel to be recorded is selected on the cable box or satellite box.

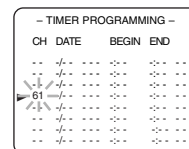

4 Select once, every day or weekly recording

For once recording :

Hit [PLAY/▲] until the desired date appears. (Example: "7/04" for July 4th)

Then hit [F.FWD/▶].

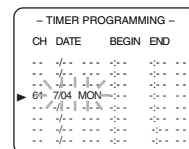

For every day recording : To record a TV program at the same time on the same channel every day. (Example: Monday through Sunday)

Hit [STOP/▼] until "EVRY DAY" appears, then hit [F.FWD/▶].

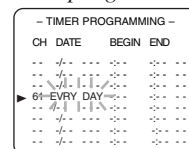

For weekly recording : To record a TV program at the same time on the same channel every week. (Example: every Monday)

Hit [STOP/▼] until "EVRY" and your desired day of the week appear together, then hit [F.FWD/▶].

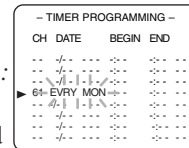

5 Set beginning hour

Press [PLAY/▲] or [STOP/▼] until the desired hour appears. (Example: "7, PM" for 7:30PM) Then hit [F.FWD/▶].

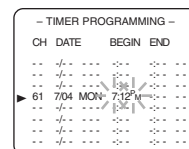

6 Set beginning minute

Press [PLAY/▲] or [STOP/▼] until the desired minute appears. (Example: "30" for 7:30PM) Then hit [F.FWD/▶].

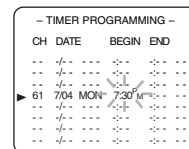

7 Set end hour

Press [PLAY/▲] or [STOP/▼] until the desired hour appears. (Example: "8, PM" for 8:50PM) Then hit [F.FWD/▶].

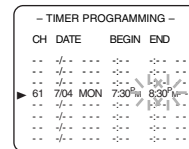

8 Set end minute

Press [PLAY/▲] or [STOP/▼] until the desired minute appears. (Example: "50" for 8:50PM) Then hit [F.FWD/▶].

- TIMER PROGRAMMING -			
CH	DATE	BEGIN	END
--	----	----	----
--	----	----	----
▶ 61	7/04 MON	7:30 ^{AM}	8:50 ^{PM}
--	----	----	----
--	----	----	----
--	----	----	----
--	----	----	----
--	----	----	----

9 Set the tape speed

Press [PLAY/▲] or [STOP/▼] until the desired tape speed appears. (Example: "SP")

- TIMER PROGRAMMING -			
CH	DATE	BEGIN	END
--	----	----	----
--	----	----	----
▶ 61	7/04 MON	7:30 ^{AM}	8:50 ^{PM} SP
--	----	----	----
--	----	----	----
--	----	----	----
--	----	----	----
--	----	----	----
--	----	----	----

10 Finish setting the program

Hit [F.FWD/▶] to complete setting.

- To set another program, repeat steps 2 to 10.
- Hit [MENU] to exit the menu.

11 Set the timer

Hit [POWER] to set automatic timer recording. The recording indicator lights up.

- You must turn off the unit to activate automatic timer recording.
If power is not turned off and you continue watching TV, "TIMER REC STANDBY" starts flashing on the TV screen 2 minutes before the programmed start time.
- If the erase-prevention tab is removed, the cassette will be ejected when [POWER] is hit to off.

TIMER PROGRAM EXTENSION

To shift the time schedule of an automatic timer recording.

- 1) Hit [POWER].
- 2) Repeat step 1 on page 23.
- 3) Hit [RECORD] and select the desired program using [PLAY/▲] or [STOP/▼].
- 4) Hit [RECORD] again.

Each additional push will shift forward the begin/end time for recording by 10 minutes. When the recording is already in progress, each additional push will shift forward the end time only. If you want to cancel while setting, hit [PAUSE/STILL II] on the remote control. The recording time returns to the original time.

NOTE:

- When you shift forward the time schedule during recording, the recording speed will automatically be set to the SLP mode.
- 5) Press [REW/◀] or [F.FWD/▶] to exit the setting menu. Then hit [MENU] to return to original mode.

TO CORRECT A PROGRAM

- While setting a program; hit [REW/◀] to go back one step and enter the correct numbers using [PLAY/▲] or [STOP/▼].
- After setting a program;
 - 1) Hit [POWER].
 - 2) Repeat steps 1 to 2 on page 23.
 - 3) Hit [F.FWD/▶] (or hit [REW/◀] to go back one step) until the part you want to correct begins flashing, then make the changes using [PLAY/▲] or [STOP/▼].

4) Hit [POWER] to set automatic timer recording.
TO CANCEL AN AUTOMATIC TIMER RECORDING

- 1) Hit [POWER].
- 2) If recording is in progress, hit [STOP/EJECT □△] **on the unit**.
- 3) Repeat steps 1 to 2 on page 23 and select a program you want to cancel.
- 4) Hit [T-PROG. CLEAR].
- 5) Hit [MENU] to return to TV mode.

TO CONFIRM THE TIMER SETTING

- 1) Hit [POWER] so that the Recording indicator light goes off.
- 2) Hit [MENU].
- 3) Confirm "TIMER PROGRAMMING" is selected.
- 4) Hit [F.FWD/▶]. The details of programs appear on the TV screen.
- 5) Hit [MENU] to return to TV mode.

NOTES:

- The display will not be turned on automatically at the time the programmed recording begins.
- If the tape runs out before the end time, the unit will switch to the stop mode immediately and the tape will be ejected.

AUTO RETURN

With this feature, after timer recording is finished, the beginning of the recorded program(s) can be searched for automatically.

1 Select "USER'S SET UP"

Hit [MENU].

Press [PLAY/▲] or [STOP/▼] to point to "USER'S SET UP", then hit [F.FWD/▶].

- MENU -	
TIMER PROGRAMMING	
PICTURE CONTROL	
SETTING CLOCK	
▶ CHANNEL SET UP	
USER'S SET UP	
V-CHIP SET UP	
LANGUAGE [ENGLISH]	
CAPTION [OFF]	
ZERO RETURN	
TIME SEARCH	

2 Set "AUTO RETURN" to [ON]

Press [PLAY/▲] or [STOP/▼] to point to "AUTO RETURN", then press [REW/◀] or [F.FWD/▶] until [ON] appears.

- USER'S SET UP -	
RENTAL	[OFF]
REPEAT PLAY	[OFF]
▶ AUTO RETURN	[ON]

3 Auto Return will begin

When all the timer recordings are completed, the unit will rewind to the beginning of the recorded program(s).
NOTE:

- If you hit [POWER] while tape is rewinding, the Auto Return will stop.

4 Watch the recorded program

Hit [PLAY/▲].

TO CANCEL THE AUTO RETURN MODE

Repeat steps 1 to 2 and select [OFF] using [REW/◀] or [F.FWD/▶].

Even if there is a power failure of any kind, the unit will retain its memory for this feature.

ON SCREEN DISPLAY

To check the Counter, Clock and Channel number on the TV screen, hit **[DISPLAY]**. Each time you hit **[DISPLAY]**, the TV screen will change as follows:

When the Closed Caption mode is OFF:

- Counter mode: After 5 seconds, only the counter remains. To clear it, hit **[DISPLAY]**.
- Clock mode: After 5 seconds, only the clock and the channel number remain. To clear them, hit **[DISPLAY]**.

When the Closed Caption mode is ON:

- The On Screen Display disappear after 5 seconds.
- This is true even if **[MUTE]** or **[PAUSE/STILL]** is pressed while recording.

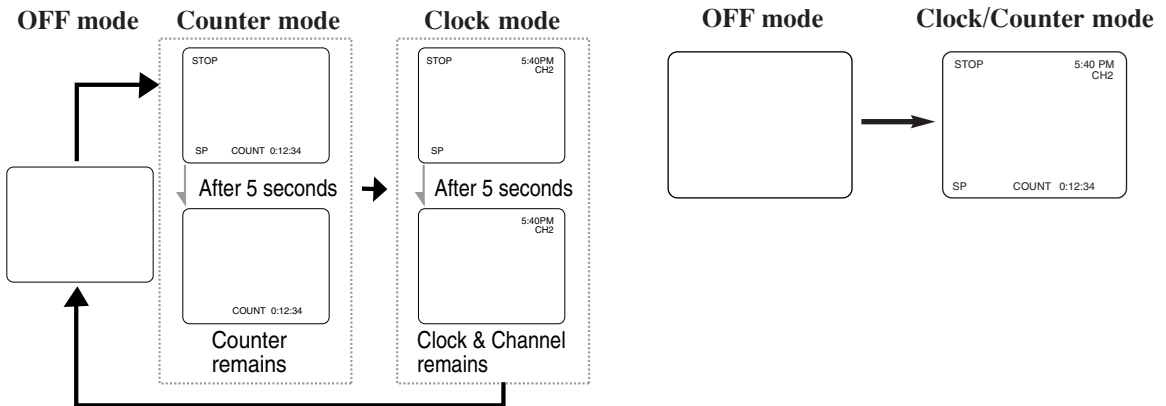

CABLE CHANNEL DESIGNATIONS

If you subscribe to cable TV, the channels are displayed as 1-125. Cable companies often designate channels with letters or letter-number combinations. Please check with your local cable company. The following is a chart of common cable channel designations.

CATV channel	5A	2	3	4	5	6	7	8	9	10	11	12	13	A	B
TV Display	1	2	3	4	5	6	7	8	9	10	11	12	13	14	15
CATV channel	C	D	E	F	G	H	I	J	K	L	M	N	O	P	Q
TV Display	16	17	18	19	20	21	22	23	24	25	26	27	28	29	30
CATV channel	R	S	T	U	V	W	W+1	W+2	W+3	W+4	W+5	W+6	W+7	W+8	W+9
TV Display	31	32	33	34	35	36	37	38	39	40	41	42	43	44	45
CATV channel	W+10	W+11	W+12	W+13	W+14	W+15	W+16	W+17	W+18	W+19	W+20	W+21	W+22	W+23	W+24
TV Display	46	47	48	49	50	51	52	53	54	55	56	57	58	59	60
CATV channel	W+25	W+26	W+27	W+28	W+29	W+30	W+31	W+32	W+33	W+34	W+35	W+36	W+37	W+38	W+39
TV Display	61	62	63	64	65	66	67	68	69	70	71	72	73	74	75
CATV channel	W+40	W+41	W+42	W+43	W+44	W+45	W+46	W+47	W+48	W+49	W+50	W+51	W+52	W+53	W+54
TV Display	76	77	78	79	80	81	82	83	84	85	86	87	88	89	90
CATV channel	W+55	W+56	W+57	W+58	A-5	A-4	A-3	A-2	A-1	W+59	W+60	W+61	W+62	W+63	W+64
TV Display	91	92	93	94	95	96	97	98	99	100	101	102	103	104	105
CATV channel	W+65	W+66	W+67	W+68	W+69	W+70	W+71	W+72	W+73	W+74	W+75	W+76	W+77	W+78	W+79
TV Display	106	107	108	109	110	111	112	113	114	115	116	117	118	119	120
CATV channel	W+80	W+81	W+82	W+83	W+84										
TV Display	121	122	123	124	125										

TROUBLESHOOTING GUIDE

If you have followed the instructions contained in this manual and have difficulty in operating your unit, locate the **PROBLEM** in the left column below. Check the corresponding **CORRECTIVE ACTION** column to remedy the problem.

PROBLEM	CORRECTIVE ACTION
No power.	<ul style="list-style-type: none"> • Make sure the AC cord is connected to an AC outlet. • Make sure the power is turned on.
No picture or sound.	<ul style="list-style-type: none"> • Make sure the AC cord is connected to an AC outlet. • Check antenna connection. • Let the unit program its tuner memory.
No picture or poor picture on the unit.	<ul style="list-style-type: none"> • Adjust direction or replace antenna. • Adjust picture controls. • Check for broken pin of the antenna cable.
No sound or poor sound.	<ul style="list-style-type: none"> • Adjust volume control on remote control or main unit. • Hit [MUTE] to restore sound.
Timer recording is not possible.	<ul style="list-style-type: none"> • Make sure the timer recording is set correctly. • Make sure the power is off. • Make sure the unit's clock is set correctly.
Cannot go into Record mode.	<ul style="list-style-type: none"> • Make sure the tape has an erase-prevention tab. If need, cover the hole with plastic tape.
Playback picture is partially noisy.	<ul style="list-style-type: none"> • Adjust tracking control for a better picture using [CHANNEL Δ/∇] on the unit.
No picture but the audio is OK in playback.	<ul style="list-style-type: none"> • Head cleaning may be necessary. Refer to "AUTO HEAD CLEANING" on page 27.
No operation by infrared Remote Control.	<ul style="list-style-type: none"> • Make sure the AC cord is connected to an AC outlet. • Check batteries in remote control.
Video or color fades in and out when making a copy of a video tape.	<ul style="list-style-type: none"> • You can not copy a copyrighted video tape. You are experiencing copy guard protection.
Different color marks on screen.	<ul style="list-style-type: none"> • Magnetism from nearby appliances and geomagnetism might affect the color of the TV picture. Move the unit away from the appliances, the unit can repair itself automatically. If you want to repair immediately, unplug the power cord, then plug it in again 30 minutes or so later. This automatically resets the unit.

CLOSED CAPTION PROBLEM	POSSIBLE REMEDY
Misspelling in captions	<ul style="list-style-type: none"> • Error committed by the closed captioning production company. Possible in a live broadcast. Not in case of a prerecorded program.
Text is not shown in its entirety or a delay occurs from what is being said.	<ul style="list-style-type: none"> • A few seconds of delay is common for live broadcast. • Display capacity may not exceed 220 words per minute. If a dialogue exceeds that rate, selective editing is used to insure that the captions remain up-to-date with the current TV screen dialogue.
Captions scrambled with white boxes	<ul style="list-style-type: none"> • Caused by interferences of building, power lines, thunderstorms, etc.
No captions in a program which must contain closed caption	<ul style="list-style-type: none"> • The broadcast may use a time compression process to speed up the program. The decoder cannot read the compressed information and captions will be lost.
No captions in a prerecorded videotape which indicated closed captions included.	<ul style="list-style-type: none"> • Possibility of a illegal copy or an erroneous copying process accidentally performed by the fabricator.
Black box in the TV screen	<ul style="list-style-type: none"> • You are in TEXT mode. Select a CAPTION mode ("C1", "C2") or Caption "OFF".

SPECIFICATIONS

GENERAL SPECIFICATIONS

CRT :	13 or 19 inch in-line gun, 90° deflection tube
Television system :	NTSC-M
Closed caption system :	§15.119/FCC
Video Heads :	Rotary two-head
Tape width :	1/2 inch
Tape speed	
SP :	33.40mm/sec.
LP :	16.67mm/sec.
SLP :	11.12mm/sec.
Tuner channel	
TV VHF Low :	#2~#6
TV VHF High :	#7~#13
TV UHF :	#14~#69
CATV	
VHF :	5A
MID band :	A5~A1, A~I
SUPER band :	J~W
HYPER band :	W+1~W+84
Terminals	
Antenna input :	VHF/UHF 75 ohms unbalanced
Video input :	RCA connector × 1
Audio input :	RCA connector × 1
Earphone :	1/8" monaural (3.5 mm)

ELECTRICAL SPECIFICATIONS

Video input level :	0.5~2.0Vp-p
Audio input level :	-15dBs
Video S/N ratio :	More than 46dB
Audio S/N ratio :	More than 43dB

OTHER SPECIFICATIONS

[13 inch model]

Power requirement :	AC 120V/60Hz
Power consumption :	60W
Dimensions :	H :15-3/8" (389mm) W:14-1/2" (367mm) D :14-7/8" (377mm)
Weight :	23.1 lbs (10.5kg)

[19 inch model]

Power requirement :	AC 120V/60Hz
Power consumption :	80W
Dimensions :	H :19-1/2" (493mm) W:19-3/8" (491mm) D :18-3/4" (475mm)
Weight :	43.0 lbs. (19.5kg)

- **Designs and specifications are subject to change without notice.**
- **If there is a discrepancy between languages, the default language will be English.**

MAINTENANCE

CABINET CLEANING

- Wipe the front panel and other exterior surfaces of the unit with a soft cloth immersed in lukewarm water and wrung dry.
- Never use a solvent or alcohol. Do not spray insecticide liquid near the unit. Such chemicals may cause damage and discoloration to the exposed surfaces.

AUTO HEAD CLEANING

- Automatically cleans video heads as you insert or remove a cassette, so you can see a clear picture.
- Playback picture may become blurred or interrupted while the TV program reception is clear. Dirt accumulated on the video heads after long periods of use, or the usage of rental or worn tapes can cause this problem.

If a streaky or snowy picture appears during playback, the video heads in your unit may need to be cleaned.

1. Please visit your local Audio/Video store and purchase a good quality VHS Video Head Cleaner.
2. If a Video Head Cleaner does not solve the problem, please call our help line mentioned on the front page, to locate an Authorized Service Center.

NOTES:

- Remember to read the instructions included with the video head cleaner before use.
- Clean video heads only when problems occur.

SERVICING

- Should your unit become inoperative, do not try to correct the problem by yourself. There are no user-serviceable parts inside. Turn off, unplug the power cord and please call our help line mentioned on the front page to locate an Authorized Service Center.

CONTROLES DE OPERACIÓN Y SUS FUNCIONES

Este manual sirve para los modelos de 13" y 19". A excepción de la apariencia, la operación de los dos modelos es exactamente la misma. En este manual se muestra el modelo de 19".

NOTA:

No recomendamos utilizar mandos a distancia universales. No todas las funciones pueden ser controladas mediante un mando a distancia universal. Si decide utilizar un mando a distancia universal con esta unidad, tenga en cuenta que con el número de código dado tal vez no se pueda controlar la unidad. En este caso, póngase en contacto con el fabricante del mando a distancia universal.

- PANEL FRONTAL -

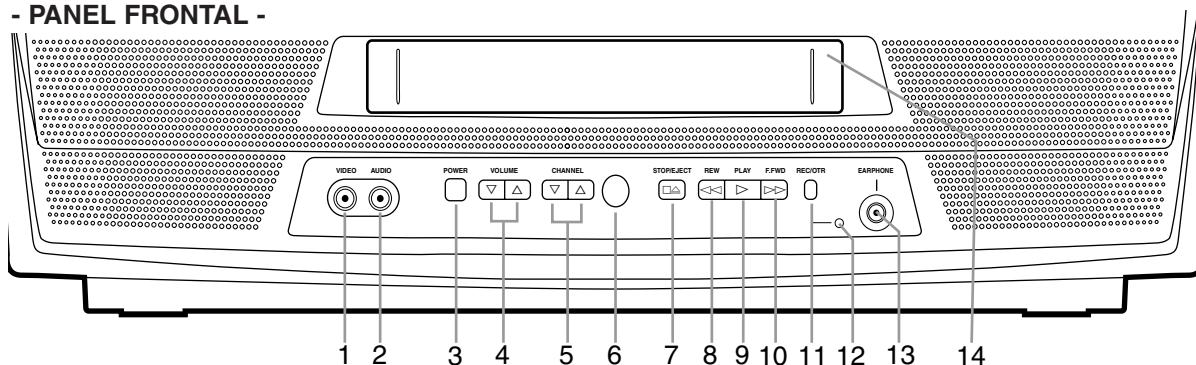

- MANDO A DISTANCIA -

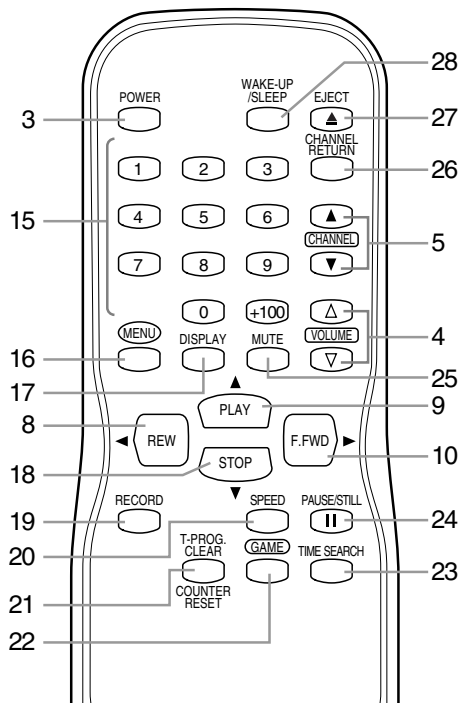

- 1 Toma de entrada VIDEO**– Conectela a la toma de salida de video de su videocámara u otra videograbadora.
- 2 Toma de entrada AUDIO**– Conectela a la toma de salida de audio de su equipo de audio, videocámara u otra videograbadora.
- 3 Botón POWER**– Presione para encender y apagar la unidad. Presione para activar la grabación con temporizador.

4 Botones VOLUME ▲/▼– Ajustan el nivel del volumen.

5 Botones CHANNEL ▲/▼– Presione para seleccionar los canales deseados para ver o grabar.

Función de seguimiento– Presione para minimizar el ruido de video (líneas o puntos en la pantalla) durante la reproducción.

6 Ventanilla del sensor de mando a distancia– Recibe las señales infrarrojas procedentes del mando a distancia.

7 Botón STOP/EJECT □/△ – Presione para parar el movimiento de la cinta. Presione en el modo de parada para expulsar el casete de la unidad.

8 Botón REW ◀◀ – Presione para rebobinar la cinta, o para ver la imagen en retroceso rápido durante el modo de reproducción. (Búsqueda con rebobinado)

Botón ◀ (Mando a distancia)

- Presione para seleccionar un modo desde un menú particular.

9 Botón PLAY ▶ – Presione para iniciar la reproducción.

Botón ▲ (Mando a distancia)

- Presione para seleccionar un modo o cifra del menú de ajustes.

10 Botón F.FWD ▶▶ – Presione para avanzar rápidamente la cinta, o para ver la imagen en avance rápido durante el modo de reproducción.

(Búsqueda con avance rápido)

Botón ▶ (Mando a distancia)

- Presione para determinar su selección y vaya al paso siguiente en el menú de ajustes.

- VISTA POSTERIOR -

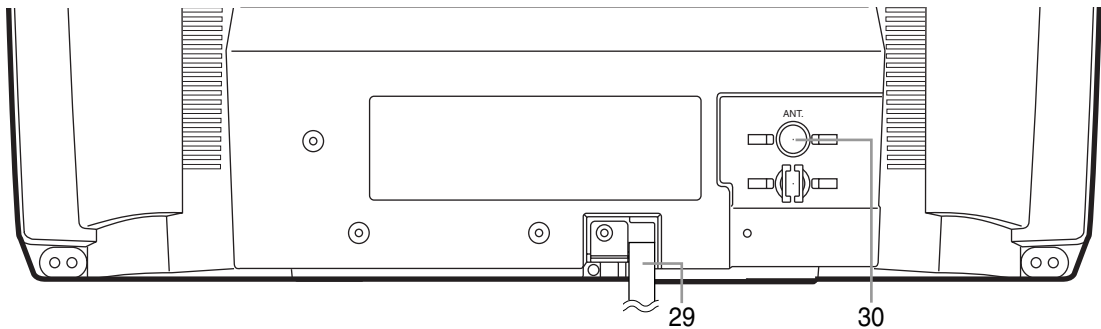

- 11 Botón REC/OTR**– Presione para iniciar la grabación manual. Presione repetidamente para empezar la grabación instantánea (OTR).
- 12 Indicador de grabación**– Parpadea durante la grabación.
Se enciende en el modo de espera de la grabación con temporizador.
- 13 Toma EARPHONE**– Para conectar los auriculares (no suministrados) y escuchar en privado. La toma es mono y tiene un tamaño de 1/8" (3,5 mm).
- 14 Compartimiento del casete**
- 15 Botones numéricos**– Presione para seleccionar los canales deseados para ver ó grabar. Para seleccionar canales del 1 al 9, presione primero el botón [0] y después el botón [1] a [9].
Botón +100– Cuando seleccione canales de televisión por cable cuyo número sea superior al 99, presione primero este botón, y después presione los dos últimos dígitos. (Para seleccionar el canal 125, presione primero el botón [+100] y luego [2] y [5].)
- 16 Botón MENU**– Presione para entrar o salir del menú de ajustes.
- 17 Botón DISPLAY**– Presione para visualizar el contador actual o el número del canal actual y la del televisor.
- 18 Botón STOP**– Presione para parar la cinta.
Botón ▼ - (Mando a distancia)
• Presione para seleccionar un modo o cifra en el menú numéricos de ajustes.
- 19 Botón RECORD**– Presione para iniciar la grabación manual.
- 20 Botón SPEED**– Presione para elegir la velocidad de grabación deseada: SP/SLP.
- 21 Botón T-PROG. CLEAR**– Presione para cancelar un programa de temporizador.
Botón COUNTER RESET– Presione para reponer el contador a 0:00:00.
- 22 Botón GAME**– Presione para establecer modo Game (juego) y el modo de entrada externa al mismo tiempo.
- 23 Botón TIME SEARCH**– Presione para activar el modo de búsqueda con tiempo.
- 24 Botón PAUSE/STILL II**– Presione para detener temporalmente la cinta durante la grabación o para ver una imagen fija durante la reproducción.
- 25 Botón MUTE**– Silencia el sonido. Presione de nuevo para recuperar el sonido.
- 26 Botón CHANNEL RETURN**– Presione para volver al canal anterior. Presione para volver al canal actual.
- 27 Botón EJECT ▲**– Presione en el modo de parada para retirar el casete de la unidad.
- 28 Botón WAKE-UP/SLEEP**– Ajusta el temporizador para despertar/dormir.
- 29 Cable de alimentación**– Conecte a la toma de CA estándar (120V/60Hz).
- 30 Toma ANT.**– Conecte a una antena, sistema de televisión por cable o sistema de satélite.

PREPARACIÓN PARA LA UTILIZACIÓN

CONEXIONES DE ANTENA/CABLE

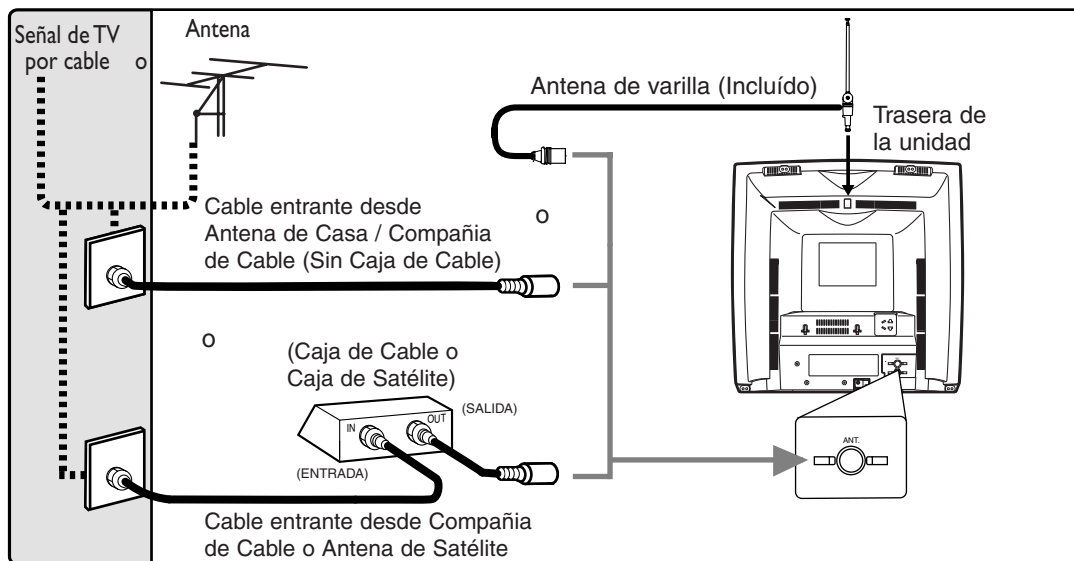

FUNCIONES Y AJUSTES

PARA MIRAR UN PROGRAMA DE TV

1 Enchufe el cable eléctrico

Enchufe el cable eléctrico de la unidad en un tomacorriente de CA del hogar.

NOTA:

- Si aparecen números en la esquina de la pantalla, presione **[POWER]** sin desenchufar el cable eléctrico.

2 Encienda la unidad

Presione **[POWER]** para encender la unidad.

3 Seleccione el número de canal

Presione **[CHANNEL ▲/▼]** o los botones numéricos para seleccionar su número de canal deseado.

Nota para el uso de los botones numéricos:

- Debe colocar un cero antes de los números de canal de una sola cifra (por ejemplo: 02, 03, 04, etc.).
- Cuando seleccione canales de cable de más de 99, presione primero **[+100]** y después las dos últimas cifras. (Ejemplo: para seleccionar el canal 125, primero presione **[+100]** y después presione **[2]** y **[5]**.)

4 Ajuste el sonido

Presione **[VOLUME ▲/▼]** para ajustar el volumen. Presione **[MUTE]** para silenciar instantáneamente el sonido. Presione nuevamente para recuperar el nivel de sonido anterior.

PARA VER CANALES DE CABLE O SATELITE

- Si la unidad está conectada a una caja de cable o caja de satélite, presione **[CHANNEL ▲/▼]** para seleccionar CH3 o CH4 de acuerdo con el ajuste de canal de salida del equipo y seleccione el canal deseado en el equipo.

PARA VER UNA ENTRADA EXTERNA

- Cuando se conecta un equipo externo en las tomas de entrada AUDIO/VIDEO frontales, presione **[CHANNEL ▲/▼]** repetidamente hasta que aparezca "AUX" en la pantalla.

AJUSTE DEL RELOJ

AJUSTE MANUAL DEL RELOJ

Asegúrese ...

- La unidad debe estar encendida.

En el siguiente ejemplo, el reloj debe estar en:

FECHA	5 de mayo, 2005
HORA DE AJUSTE	5:40PM

1 Seleccione "AJUSTE RELOJ"

Presione **[MENU]**.

Presione **[PLAY/▲]** o **[STOP/▼]** para seleccionar "AJUSTE RELOJ" y presione **[F.FWD/▶]**.

2 Seleccione "AJUSTE MANUAL RELOJ"

Presione **[PLAY/▲]** o **[STOP/▼]** para seleccionar "AJUSTE MANUAL RELOJ" y presione **[F.FWD/▶]**.

3 Seleccione el mes

Presione **[PLAY/▲]** o **[STOP/▼]** hasta que aparezca el mes deseado. (Ejemplo: Mayo → "05")

Presione **[F.FWD/▶]**.

4 Seleccione el día

Presione **[PLAY/▲]** o **[STOP/▼]** hasta que aparezca el día deseado. (Ejemplo: 5º → "05")

Presione **[F.FWD/▶]**.

5 Seleccione el año

Presione [PLAY/▲] o [STOP/▼] hasta que aparezca el año deseado. (Ejemplo: "2005")

Presione [F.FWD/▶].

6 Seleccione la hora

Presione [PLAY/▲] o [STOP/▼] hasta que aparezca la hora deseada. (Ejemplo: "5", "PM")

Presione [F.FWD/▶].

7 Seleccione los minutos

Presione [PLAY/▲] o [STOP/▼] hasta que aparezcan los minutos deseados. (Ejemplo: "40")

8 Haga funcionar el reloj

Presione [MENU].

Aunque no aparezcan los segundos, empezará a contar desde 00 cuando presione [MENU]. Utilice esta característica para sincronizar el reloj con la hora real.

NOTA:

- Cuando desenchufe el cable de CA o si hay un corte eléctrico de más de 3 segundos, puede ser necesario reajustar el reloj.

IDIOMA DEL MENÚ

1 Seleccione "LANGUAGE"

Presione [MENU].

Presione [PLAY/▲] o [STOP/▼] para seleccionar al "LANGUAGE".

2 Seleccione "ENGLISH", "ESPAÑOL" o "FRANÇAIS"

Presione [REW/◀] o [F.FWD/▶] repetidamente para seleccionar "ENGLISH" = inglés, "ESPAÑOL" o "FRANÇAIS" = francés.

3 Salga del modo de idioma

Presione [MENU] para volver al modo de TV.

NOTAS:

- Esta función afecta sólo el idioma en el menú de la pantalla y no la fuente de audio.
- Si por alguna razón, el menú está en francés, presione [MENU], presione [PLAY/▲] o [STOP/▼] para seleccionar al "LANGAGE [FRANÇAIS]" y presione [F.FWD/▶] repetidamente para seleccionar el idioma deseado y presione [MENU].

REPRODUCCION NORMAL

Asegúrese ...

- La unidad debe estar encendida.

1 Inserte una cinta pregrabada.

Si la lengüeta para evitar el borrado está rota, la unidad empezará a reproducir automáticamente.

2 Para empezar a reproducir

Presione [PLAY/▲].

NOTA:

- Si hay un menú activado en la pantalla, [PLAY/▲] no funciona. Presione [MENU] para salir el menú. Después presione [PLAY/▲].



3 Para parar la reproducción

Presione [STOP/▼].



GRABACIÓN NORMAL

SOLO puede ver el mismo programa de TV que está grabando.

1 Seleccione el canal a grabar

Presione los botones numéricos o [CHANNEL ▲/▼].

NOTA:

- Si la unidad está conectada a una caja de cable o caja de satélite, la unidad debe estar en el CH3 o CH4 y el canal a grabar debe seleccionarse en la caja de cable o caja de satélite.

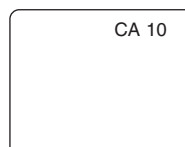

2 Seleccione la velocidad de la cinta

Presione [SPEED] para seleccionar la velocidad deseada de la cinta (SP/SLP).



3 Empiece a grabar

Presione [RECORD].

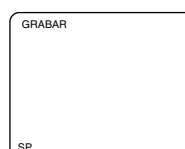

4 Pare la grabación

Presione [STOP/▼].

SYLVANIA

LIMITED WARRANTY

FUNAI CORP. will repair this SYLVANIA product, free of charge in the USA in the event of defect in materials or workmanship as follows:

DURATION:

PARTS: FUNAI CORP. will provide parts to replace defective parts without charge for one (1) year from the date of original retail purchase. Two (2) years for Picture Tube. Certain parts are excluded from this warranty.

LABOR: FUNAI CORP. will provide the labor without charge for a period of ninety (90) days from the date of original retail purchase.

LIMITS AND EXCLUSIONS:

This warranty is extended only to the original retail purchaser. A purchase receipt or other proof of original retail purchase will be required together with the product to obtain service under this warranty.

This warranty shall not be extended to any other person or transferee.

This warranty is void and of no effect if any serial numbers on the product are altered, replaced, defaced, missing or if service was attempted by an unauthorized service center. This SYLVANIA Limited warranty does not apply to any product not purchased and used in the United States.

This warranty only covers failures due to defects in material or workmanship which occurs during normal use. It does not cover damage which occurs in shipment, or failures which are caused by repairs, alterations or product not supplied by FUNAI CORP., or damage which results from accident, misuse, abuse, mishandling, misapplication, alteration, faulty installation, improper maintenance, commercial use such as hotel, rental or office use of this product or damage which results from fire, flood, lightning or other acts of God.

THIS WARRANTY DOES NOT COVER PACKING MATERIALS, ANY ACCESSORIES (EXCEPT REMOTE CONTROL), ANY COSMETIC PARTS, COMPLETE ASSEMBLY PARTS, DEMO OR FLOOR MODELS.

FUNAI CORP. AND ITS REPRESENTATIVES OR AGENTS SHALL IN NO EVENT BE LIABLE FOR ANY GENERAL, INDIRECT OR CONSEQUENTIAL DAMAGES ARISING OUT OF OR OCCASIONED BY THE USE OF OR THE INABILITY TO USE THIS PRODUCT. THIS WARRANTY IS MADE IN LIEU OF ALL OTHER WARRANTIES, EXPRESS OR IMPLIED, AND OF ALL OTHER LIABILITIES ON THE PART OF FUNAI. ALL OTHER WARRANTIES INCLUDING THE WARRANTY OF MERCHANTABILITY AND FITNESS FOR A PARTICULAR PURPOSE, ARE HEREBY DISCLAIMED BY FUNAI AND ITS REPRESENTATIVES IN THE UNITED STATES. ALL WARRANTY INSPECTIONS AND REPAIRS MUST BE PERFORMED BY A FUNAI AUTHORIZED SERVICE CENTER. THIS WARRANTY IS ONLY VALID WHEN THE UNIT IS CARRIED-IN TO A FUNAI AUTHORIZED SERVICE FACILITY.

IMPORTANT:

THIS LIMITED WARRANTY GIVES YOU SPECIFIC LEGAL RIGHTS. YOU MAY HAVE OTHER RIGHTS THAT VARY FROM STATE TO STATE. IF, AT ANY TIME DURING THE WARRANTY PERIOD, YOU ARE UNABLE TO OBTAIN SATISFACTION WITH THE REPAIR OF THIS PRODUCT, PLEASE CONTACT FUNAI CORP.

ATTENTION:

FUNAI CORP. RESERVES THE RIGHT TO MODIFY ANY DESIGN OF THIS PRODUCT WITHOUT PRIOR NOTICE.

To locate your nearest Authorized Service Center or for general service inquiries, please call or write to the following:

**FUNAI CORPORATION, INC.
SERVICE CENTER**

19900 Van Ness Avenue, Torrance, CA 90501

Tel :1-800-968-3429

<http://www.SylvaniaConsumerElectronics.com>

Head Office: 100 North Street, Teterboro, NJ 07608

PLEASE DO NOT SHIP YOUR UNIT TO THE TETERBORO ADDRESS.

Free Manuals Download Website

<http://myh66.com>

<http://usermanuals.us>

<http://www.somanuals.com>

<http://www.4manuals.cc>

<http://www.manual-lib.com>

<http://www.404manual.com>

<http://www.luxmanual.com>

<http://aubethermostatmanual.com>

Golf course search by state

<http://golfingnear.com>

Email search by domain

<http://emailbydomain.com>

Auto manuals search

<http://auto.somanuals.com>

TV manuals search

<http://tv.somanuals.com>