

# SYLVANIA

## OWNER'S MANUAL

### VIDEO CASSETTE RECORDER

# C6240VE



If you need additional operating assistance after reading this owner's manual or to order replacement accessories, please call  
**TOLL FREE : 1-800-287-4871**

## 1. Before using your VCR

### Basic VCR/TV Connection

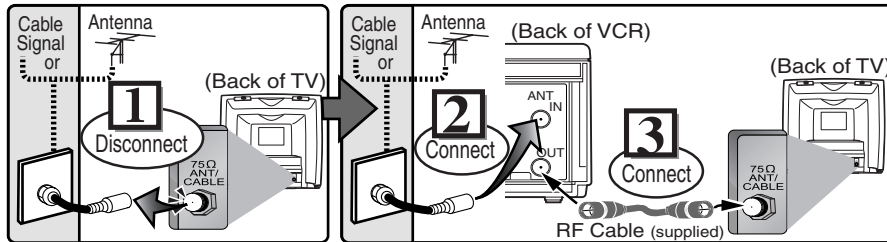

**4** Plug the AC power cords of the VCR and TV into the AC outlets.

### Hint for Cable Box or Satellite Box

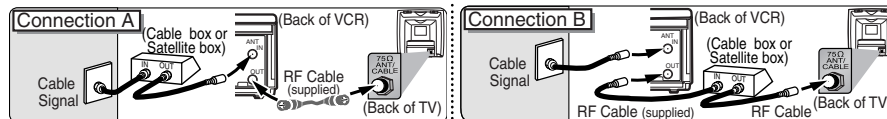

Select this connection when you want to view or record a scrambled channel.

- With this connection, channels cannot be changed on the VCR. You can view or record **ONLY** the channels you have selected on the cable box or the satellite box.
- While you are recording, only the recorded channel can be viewed.

#### To select channels of the cable box or satellite box

- 1) Turn on the VCR by pressing the POWER button, and then, press the VCR/TV button. The POWER and the VCR/TV indicators on the front panel will light on. Then, press the CHANNEL buttons to select channel 3 or 4 (the same channel as the output channel of the cable box or satellite box).
- If you use the channel 4, you need to change the VCR's RF output to channel 4. Refer to "RF Output Channel".
- 2) At the TV, select channel 3 or 4 (the same channel as you have selected at step 1).
- 3) At the cable box or satellite box, select the channel you want to view or record.

Select this connection when you want to change channels on the VCR. With this connection, you may watch one channel while recording another.

- You may not view or record a scrambled channel.

#### To select channels of the cable box or satellite box

- 1) At the cable box or satellite box, select channel 3 or 4 (the same channel as the VCR's RF output channel.)
- Refer to "RF Output Channel".
- 2) At the TV, select the same channel as the output channel (3 or 4) of the cable box or satellite box.
- 3) Turn on the VCR by pressing the POWER button, and then, press the VCR/TV button. The POWER and VCR/TV indicators on the front panel will light on. Then, select the channel you want to view or record.

#### To play back a tape

- 1) Follow the steps 1) to 2) above. Then, play back a tape.
- Refer to "Playback" on page 5.

#### To view one channel while recording another

- 1) While you are recording on the VCR, press the VCR/TV button so that the VCR/TV indicator disappears on the VCR.
- 2) At the cable box or satellite box, select the channel you want to view.

### RF Output Channel

If channel 3 is already occupied for broadcasting,

- 1) Set your TV to channel 4.
- 2) Insert a pre-recorded tape into the VCR.
- 3) Press the PLAY button once.
- 4) After a few seconds, press the PLAY button **on the VCR** for 3 seconds.
  - The RF output channel will change to channel 4 from channel 3 and you will see a playback picture.
  - When a picture does not appear on the TV screen, repeat step [4].
- 5) Press the STOP button to stop playback.

### Hint

- The RF output channel may not change when you adjust tracking during playback. In this case, stop the playback, and start the playback again. After that, press the PLAY button on the VCR for 3 seconds again.

### Stereo TV Connection

You can use the AUDIO OUT jack and VIDEO OUT jack on the back of the VCR if your TV has Audio/Video Input jacks. In this case, you need to set the TV to external Line Input Mode. Please refer to your TV's owner's manual.

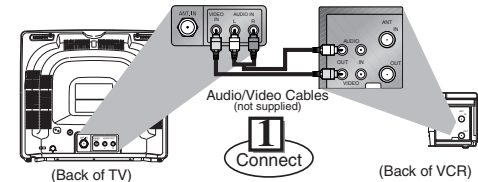

### Front & Rear Terminals

#### AUDIO OUT jack

Connect the audio cable to the audio in jack of a camcorder, another VCR, a stereo amplifier, or an audio system.

#### AUDIO IN jack

Connect the audio cable from the audio out jack of a camcorder, another VCR, or an audio source.

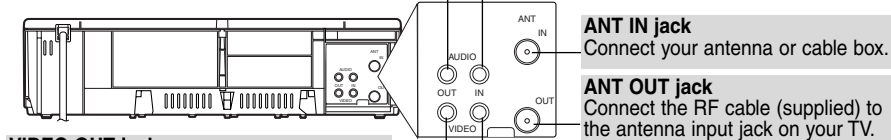

#### ANT IN jack

Connect your antenna or cable box.

#### ANT OUT jack

Connect the RF cable (supplied) to the antenna input jack on your TV.

#### VIDEO OUT jack

Connect the video cable to the video in jack of a camcorder, another VCR, or a TV.

#### VIDEO IN jack

Connect the video cable from the video out jack of a camcorder, another VCR, or an audio-visual source (laser disc player, video disc player, etc.).

### Supplied Accessory

- Remote control (NA371UD) with Two AA batteries
- RF Cable (WPZ0901TM002)
- Owner's Manual (0VMN04007)



### Installing the Batteries for the Remote Control

Install two AA batteries (supplied) matching the polarity indicated on the bottom of the remote control.

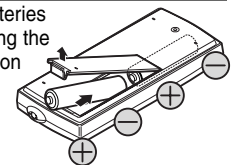

Printed in China

0VMN04007 / HF350CD ★★★★★

# 2. Important Safeguards

**WARNING: TO REDUCE THE RISK OF FIRE OR ELECTRIC SHOCK, DO NOT EXPOSE THIS APPLIANCE TO RAIN OR MOISTURE.**



**CAUTION**  
RISK OF ELECTRIC SHOCK  
DO NOT OPEN



**CAUTION:** TO REDUCE THE RISK OF ELECTRIC SHOCK, DO NOT REMOVE COVER (OR BACK). NO USER SERVICEABLE PARTS INSIDE. REFER SERVICING TO QUALIFIED SERVICE PERSONNEL.

The caution marking is located on the rear of the cabinet.



The lightning flash with arrowhead symbol, within an equilateral triangle, is intended to alert the user to the presence of uninsulated "dangerous voltage" within the product's enclosure that may be of sufficient magnitude to constitute a risk of electric shock to persons.



The exclamation point within an equilateral triangle is intended to alert the user to the presence of important operating and maintenance (servicing) instructions in the literature accompanying the product.

- 1. Read Instructions-** All the safety and operating instructions should be read before the appliance is operated.
- 2. Retain Instructions-** The safety and operating instructions should be retained for future reference.
- 3. Heed Warnings-** All warnings on the appliance and in the operating instructions should be adhered to.
- 4. Follow Instructions-** All operating and use instructions should be followed.
- 5. Cleaning-** Unplug this video product from the wall outlet before cleaning. Do not use liquid cleaners or aerosol cleaners. Use a damp cloth for cleaning.  
**EXCEPTION:** A product that is meant for uninterrupted service and, that for some specific reason, such as the possibility of the loss of an authorization code for a CATV converter, is not intended to be unplugged by the user for cleaning or any other purpose, may exclude the reference to unplugging the appliance in the cleaning description otherwise required in item 5.
- 6. Attachments-** Do not use attachments not recommended by the video product manufacturer as they may cause hazards.
- 7. Water and Moisture-** Do not use this video product near water, for example, near a bath tub, wash bowl, kitchen sink, or laundry tub, in a wet basement, or near a swimming pool, and the like.
- 8. Accessories-** Do not place this video product on an unstable cart, stand, tripod, bracket, or table. The video product may fall, causing serious injury to a child or adult, and serious damage to the appliance. Use only with a cart, stand, tripod, bracket, or table recommended by

the manufacturer, or sold with the video product. Any mounting of the appliance should follow the manufacturer's instructions and should use a mounting accessory recommended by the manufacturer. An appliance and cart combination should be moved with care. Quick stops, excessive force, and uneven surfaces may cause the appliance and cart combination to overturn.



- 9. Ventilation-** Slots and openings in the cabinet are provided for ventilation and to ensure reliable operation of the video product and to protect it from overheating, and these openings must not be blocked or covered. The openings should never be blocked by placing the video product on a bed, sofa, rug, or other similar surface. This video product should not be placed in a built-in installation such as a bookcase or rack unless proper ventilation is provided or the manufacturer's instructions have been adhered to.
- 10. Power Sources-** This video product should be operated only from the type of power source indicated on the marking label. If you are not sure of the type of power supply to your home, consult your appliance dealer or local power company. For products intended to operate from battery power, or other sources, refer to the operating instructions.
- 11. Grounding or Polarization-** This video product is equipped with a polarized alternating-current line plug (a plug having one blade wider than the other). This plug will fit into the power outlet only one way. This is a safety feature. If you are unable to insert the plug fully into the outlet, try reversing the plug. If the plug should still fail to fit, contact your electrician to replace your obsolete outlet. Do not defeat the safety purpose of the polarized plug.

- 12. Power Cord Protection-** Power supply cords should be routed so that they are not likely to be walked on or pinched by items placed upon or against them, paying particular attention to cords at plugs, convenience receptacles, and the point where they exit from the appliance.
- 13. Outdoor Antenna Grounding-** If an outside antenna or cable system is connected to the video product, be sure the antenna or cable system is grounded so as to provide some protection against voltage surges and built-up static charges. Article 810 of the National Electrical Code, ANSI/NFPA No. 70, provides information with regard to proper grounding of the mast and supporting structure, grounding of the lead-in wire to an antenna discharge unit, size of grounding conductors, location of antenna-discharge unit, connection to grounding electrodes, and requirements for the grounding electrode. (Fig. A)

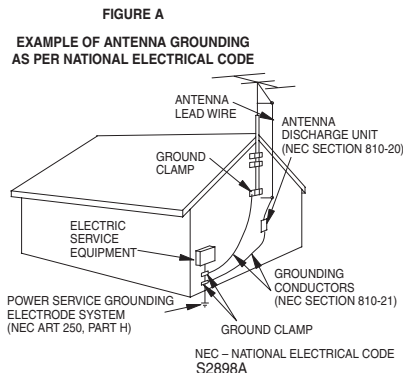

- 14. Lightning-** For added protection for this video product during a lightning storm, or when it is left unattended and unused for long periods of time, unplug it from the wall outlet and disconnect the antenna or cable system. This will prevent damage to the video product due to lightning and power-line surges.
- 15. Power Lines-** An outside antenna system should not be located in the vicinity of overhead power lines or other electric light or power circuits, or where it can fall into such power lines or circuits. When installing an outside antenna system, extreme care should be taken to keep from touching such power lines or circuits as contact with them might be fatal.
- 16. Overloading-** Do not overload wall outlets, extension cords, or integral convenience receptacles as this can result in a risk of fire or electric shock.

- 17. Object and Liquid Entry-** Never push objects of any kind into this video product through any openings as they may touch dangerous voltage points or short-out parts that could result in a fire or electric shock. Never spill liquid of any kind on the video product.
- 18. Servicing-** Do not attempt to service this video product yourself as opening or removing covers may expose you to dangerous voltage or other hazards. Refer all servicing to qualified service personnel.
- 19. Damage Requiring Service-** Unplug this video product from the wall outlet and refer servicing to qualified service personnel under the following conditions:
  - When the power-supply cord or plug is damaged.
  - If liquid has been spilled, or objects have fallen into the video product.
  - If the video product has been exposed to rain or water.
  - If the video product does not operate normally by following the operating instructions. Adjust only those controls that are covered by the operating instructions as an improper adjustment of other controls may result in damage and will often require extensive work by a qualified technician to restore the video product to its normal operation.
  - If the video product has been dropped or damaged in any way.
  - When the video product exhibits a distinct change in performance-this indicates a need for service.

- 20. Replacement Parts-** When replacement parts are required, be sure the service technician has used replacement parts specified by the manufacturer or have the same characteristics as the original part. Unauthorized substitutions may result in fire, electric shock or other hazards.
- 21. Safety Check-** Upon completion of any service or repairs to this video product, ask the service technician to perform safety checks to determine that the video product is in proper operating condition.
- 22. Heat-** This video product should be situated away from heat sources such as radiators, heat registers, stoves, or other products (including amplifiers) that produce heat.

# 3. Preset for Use

## Turn on the VCR for the first time

**1** Turn on the TV and set it to channel 3.

- If channel 3 is already occupied for broadcasting, see "RF Output Channel" section.



**2** Press the **POWER** button on the Remote Control to turn on the TV. Press the **STOP** or **PLAY** button on the remote control to select the language.

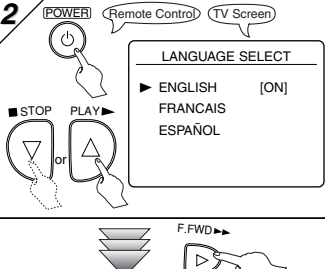

LANGUAGE SELECT

- ▶ ENGLISH [ON]
- FRANCAIS
- ESPAÑOL

**3** Press the **F.FWD** button on the remote control to scan for channels.

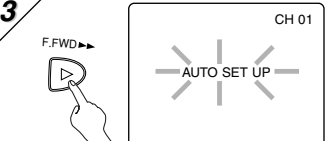

CH 01

AUTO SET UP

Do you connect the cable of the cable box or the satellite box to the VCR's ANT IN jack?

**Yes** Press the **MENU** button to exit

- Refer to "Hint for Cable Box or Satellite Box" section on page 1.

**No** Please wait for a few minutes.

After scanning...

- The tuner stops on the lowest memorized channel.
- You can select only the channels memorized in VCR by using the CHANNEL buttons.
- If "AUTO SET UP" appears on the TV screen again, check the cable connections. Then, press the F.FWD button once again.

**Hint**

- Repeat these steps only if there was a power failure or if the VCR has been unplugged for more than 30 seconds.

## To Select a Channel

You can select a channel by directly pressing the Number buttons on the remote control.

### Notes for using the Number buttons:

- When selecting cable channels which are higher than 99, enter channel numbers as a three-digit number. (For example: 117, press 1,1,7)
- You must precede single-digit channel numbers with a zero (For example: 02, 03, 04 and so on).

## To Preset the Channel Again

- 1) Press the **MENU** button until the main menu appears.
- 2) Select "**CHANNEL SET UP**" by pressing the **PLAY** or **STOP** button. Then, press the **F.FWD** button.
- 3) Select "**AUTO SET UP**" by pressing the **PLAY** or **STOP** button. Then, press the **F.FWD** button. After scanning, the tuner stops on the lowest memorized channel.

## To Change the On-Screen Language

- 1) Press the **MENU** button until the main menu appears.
- 2) Select "**LANGUAGE SELECT**" by pressing the **PLAY** or **STOP** button. Then, press the **F.FWD** button.
- 3) Select "**ENGLISH**", "**FRANCAIS**" or "**ESPAÑOL**" by pressing the **PLAY** or **STOP** button. Then, press the **C.RESET/EXIT** button.

## Hint

- If you accidentally select Spanish or French and need English: Press the **MENU** button and choose **SELEC. IDIOMA**, or **SELECTION LANGUAGE**. Press the **F.FWD** button, and select **ENGLISH**. Finally, press the **C.RESET/EXIT** button.

## To Add/Delete Channels

**1** Press the **MENU** button until the main menu appears.

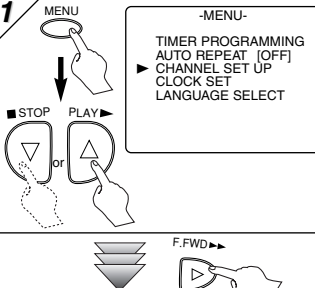

-MENU-

- TIMER PROGRAMMING
- AUTO REPEAT [OFF]
- ▶ CHANNEL SET UP
- CLOCK SET
- LANGUAGE SELECT

STOP PLAY

F.FWD

**2** Press the **STOP** or **PLAY** button to select "CHANNEL SET UP".

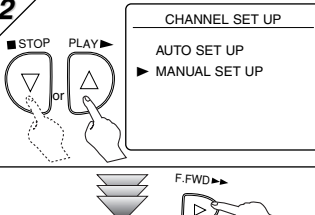

CHANNEL SET UP

- ▶ AUTO SET UP
- MANUAL SET UP

F.FWD

**3** Press the **STOP** or **PLAY** button to select "MANUAL SET UP".

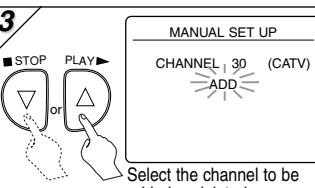

MANUAL SET UP

CHANNEL 30 (CATV)

ADD

Select the channel to be added or deleted.

F.FWD

**4** Press the **REW** or **F.FWD** button to select "ADD" or "DELETE".

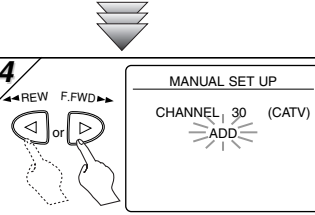

MANUAL SET UP

CHANNEL 30 (CATV)

ADD

Select "ADD" or "DELETE"

F.FWD

**5** Press the **C.RESET/EXIT** button to exit the menu.

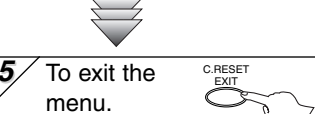

C.RESET/EXIT

## Clock Set Up

**1** Press the **MENU** button until the main menu appears.

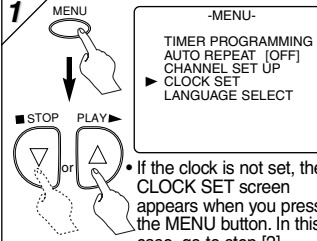

-MENU-

- TIMER PROGRAMMING
- AUTO REPEAT [OFF]
- ▶ CHANNEL SET UP
- CLOCK SET
- LANGUAGE SELECT

STOP PLAY

F.FWD

**2** Press the **STOP** or **PLAY** button to select "CLOCK SET".

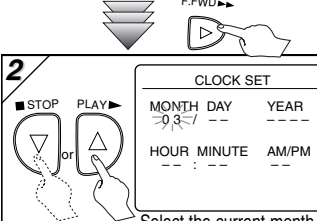

CLOCK SET

MONTH DAY YEAR

03 / 15 MON 2004

HOUR MINUTE AM/PM

05 : 40 PM

Select the current month

F.FWD

**3** Press the **STOP** or **PLAY** button to select the current day.

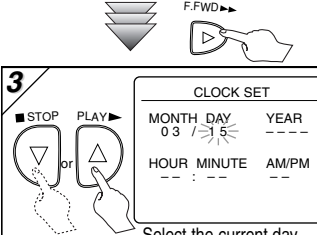

CLOCK SET

MONTH DAY YEAR

03 / 15 MON 2004

HOUR MINUTE AM/PM

05 : 40 PM

Select the current day

F.FWD

**4** Press the **STOP** or **PLAY** button to select the current year.

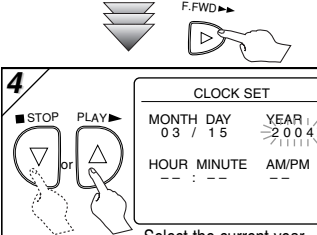

CLOCK SET

MONTH DAY YEAR

03 / 15 MON 2004

HOUR MINUTE AM/PM

05 : 40 PM

Select the current year

F.FWD

**5** Press the **STOP** or **PLAY** button to select the current hour.

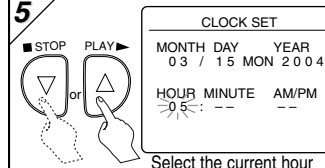

CLOCK SET

MONTH DAY YEAR

03 / 15 MON 2004

HOUR MINUTE AM/PM

05 : 40 PM

Select the current hour

F.FWD

**6** Press the **STOP** or **PLAY** button to select the current minute.

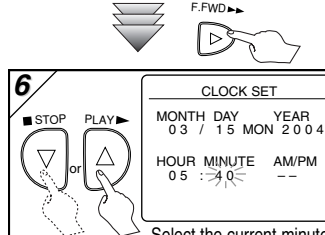

CLOCK SET

MONTH DAY YEAR

03 / 15 MON 2004

HOUR MINUTE AM/PM

05 : 40 PM

Select the current minute

F.FWD

**7** Press the **STOP** or **PLAY** button to select "AM" or "PM".

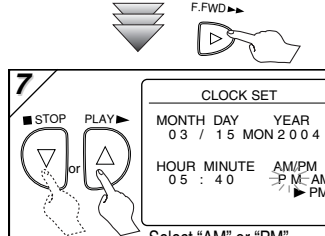

CLOCK SET

MONTH DAY YEAR

03 / 15 MON 2004

HOUR MINUTE AM/PM

05 : 40 PM

Select "AM" or "PM"

F.FWD

**8** To exit the **CLOCK SET** screen.



F.FWD

## Hint

- To go back one step, press the **REW** button (during the steps [2] to [7].)
- Your clock setting will be lost if there is a power failure or if the VCR has been unplugged for more than 30 seconds.

# 4. Precautions

## Precautions

### Install Location

For safety and optimum performance of your VCR:

- Install the VCR in a horizontal and stable position. Do not place anything directly on top of the VCR. Do not place the VCR directly on top of the TV.
- Shield it from direct sunlight and keep it away from sources of intense heat. Avoid dusty or humid places. Avoid places with insufficient ventilation for proper heat dissipation. Do not block the ventilation holes on the sides of the VCR. Avoid locations subject to strong vibration or strong magnetic fields.

### Avoid the Hazards of Electrical Shock and Fire

- Do not handle the power cord with wet hands.
- Do not pull on the power cord when disconnecting it from AC wall outlet. Grasp it by the plug.

### Moisture Condensation Warning

Moisture condensation may occur inside the unit when it is moved from a cold place to a warm place, or after heating a cold room or under conditions of high humidity. Do not use the VCR at least for 2 hours until its inside is dry.

### FCC Warning

This equipment may generate or use radio frequency energy. Changes or modifications to this equipment may cause harmful interference unless the modifications are expressly approved in the instruction manual. The user could lose the authority to operate this equipment if an unauthorized change or modification is made.

### Important Copyright Information

Unauthorized recording or use of broadcast television programming, video tape, film or other copyrighted material may violate applicable copyright laws. We assume no responsibility for the unauthorized duplication, use, or other acts which infringe upon the rights of copyright owners.

### A Note about Recycling

This product's packaging materials are recyclable and can be reused. Please dispose of any materials in accordance with your local recycling regulations. Batteries should never be thrown away or incinerated but disposed of in accordance with your local regulations concerning chemical wastes.

### Note to the Cable TV System Installer

This reminder is provided to call the Cable TV system installer's attention to Article 820-40 of the National Electrical Code, which provides guidelines for proper grounding – in particular, specifying that the cable ground shall be connected to the grounding system of the building, as close to the point of cable entry as possible.

**CAUTION:**  
**TO PREVENT ELECTRIC SHOCK,**  
**MATCH WIDE BLADE OF PLUG TO**  
**WIDE SLOT, FULLY INSERT.**  
**ATTENTION:**  
**POUR ÉVITER LES CHOC**  
**ÉLECTRIQUES, INTRODUIRE LA**  
**LAME LA PLUS LARGE DE LA**  
**FICHE DANS LA BORNE CORRE-**  
**SPONDANTE DE LA PRISE ET**  
**POUSSER JUSQU'AU FOND.**

## Troubleshooting Guide

If you are having problems operating your product even though you have followed the instructions in this manual, check the following list of problems and corrective actions. You may be able to solve the problem yourself.

PROBLEM	CORRECTIVE ACTION
No power.	<ul style="list-style-type: none"> <li>• Make sure the power plug is connected to an AC outlet.</li> <li>• Make sure the power is turned on.</li> </ul>
Timer recording is impossible.	<ul style="list-style-type: none"> <li>• Make sure the timer recording is set correctly.</li> <li>• Make sure the power is off.</li> <li>• Make sure the VCR clock is set correctly.</li> </ul>
Cannot go into Recording mode.	<ul style="list-style-type: none"> <li>• Make sure the tape has a record tab. If needed, cover the hole with cellophane tape.</li> </ul>
Playback picture is partially noisy.	<ul style="list-style-type: none"> <li>• Adjust tracking control for a better picture by pressing the CHANNEL buttons.</li> </ul>
No playback picture (only sound can be heard.)	<ul style="list-style-type: none"> <li>• Head cleaning may be necessary. Refer to "Auto Head Cleaning" on page 8.</li> <li>• Make sure the VCR is not in the Menu mode.</li> </ul>
No or poor playback picture.	<ul style="list-style-type: none"> <li>• Turn on the TV and set the TV to channel 3. If channel 3 is already occupied for broadcasting, change the RF output to channel 4, and change the TV channel to channel 4. (See "RF Output Channel" on page 1 for the detail.)</li> <li>• Fine tune the channel reception on your TV.</li> </ul>
TV programs cannot be seen normally.	<ul style="list-style-type: none"> <li>• Re-check the ANT. IN and ANT. OUT connections. See page 1.</li> <li>• Press the VCR/TV button on the remote control so that the VCR/TV indicator on the VCR disappears.</li> </ul>
No VCR operation from the infrared Remote Control.	<ul style="list-style-type: none"> <li>• Make sure the power plug is connected to an AC outlet.</li> <li>• Check batteries in remote control.</li> </ul>
Video or color fades in and out when making a copy of a video tape.	<ul style="list-style-type: none"> <li>• You cannot copy a copyrighted video tape. You are experiencing copy guard protection.</li> </ul>

## Specifications

Video Heads :	Four Heads	Power requirement :	120V, 60Hz
Operating temperature :	41°F~104°F (5°C~40°C)	Power consumption :	14 Watts
Converter output :	VHF Channel 3 or 4.	Dimensions :	W 14-3/16" (360mm) H 3-5/8" (92mm) D 8-9/16" (216mm)
		Weight :	4.0 lbs. (1.8 Kg.) (approx.)

- Designs and specifications are subject to change without notice and legal obligation.
- If an explanation in the Owner's Manual is not consistent across languages, please refer to the English version.

## 5. Playback

Before:  
Turn on the TV and set it to channel 3.

- If channel 3 is already occupied for broadcasting, see "RF Output Channel" section.

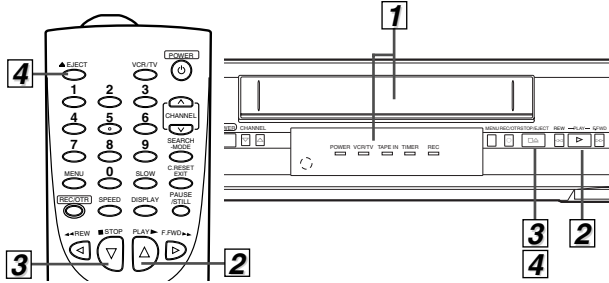
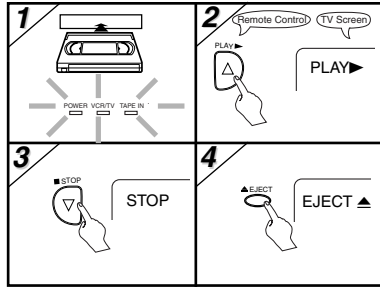

### Hint

- When a tape without record tab is inserted, the VCR will start playback automatically at step [1].
- Tracking will be automatically adjusted upon playback. To adjust the tracking manually, press the CHANNEL buttons.

## 6. Recording & OTR (One Touch Recording)

Before:  
Turn on the TV and set it to channel 3.

- If channel 3 is already occupied for broadcasting, see "RF Output Channel" section.

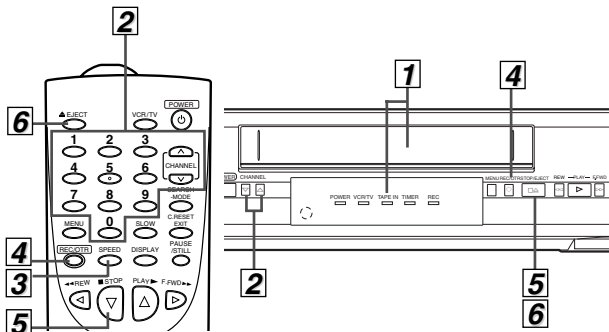
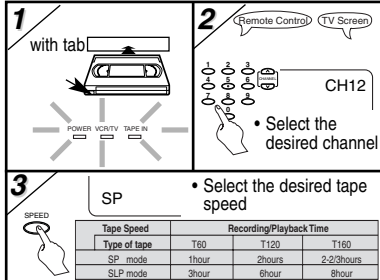

### Accidental erasure prevention

To prevent accidental recording on a recorded cassette, remove its record tab. To record on it later, cover the hole with cellophane tape.

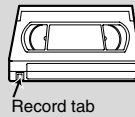

### Hint

- If you have connected the VCR to a cable box or satellite box, refer to "Hint for Cable Box or Satellite Box" section on page 1.

## 7. Other Operations

### To cue or review picture during playback (Picture Search)

- Press the **F.FWD** or **REW** button.
- Press it again and the VCR will now search in super high speed. (in the LP/SLP modes only)

### To freeze the picture on TV screen during playback (Still mode)

- Press the **PAUSE/STILL** button. Each time you press the button, the picture will be forwarded by one frame.
- If the picture begins to vibrate vertically during the still mode, stabilize the picture by pressing the CHANNEL buttons.
- If the picture is distorted or rolling vertically, adjust the vertical hold control on your TV, if equipped.

### Counter Reset

- Press the **C.RESET/EXIT** button.

### To play back in slow motion

Press the **SLOW** button during playback or the still mode.

- If the noise bar appears on the TV screen, you can reduce it by pressing the CHANNEL buttons.

### To temporarily stop recording (Pause mode)

Press the **PAUSE/STILL** button.

- During the rec pause mode, five ■ marks appear on the TV screen. Each ■ mark represents one minute.
- Press it again to resume recording.

### Auto Rewind

When a tape reaches its end during playback, fast-forward, or recording (except timer recording and One Touch Recording), the tape will automatically rewind to the beginning. After rewinding finishes, the VCR will eject the tape and turn itself off.

### Hint

- Still/Slow/Pause mode will be automatically cancelled after 5 minutes to prevent damage to the tape and the video head.
- To return to playback from the Picture Search/Still/Slow mode, press the PLAY button.

## 8. On-Screen Operations

### 1 To call up the main menu

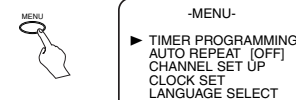

### 2 To select an item

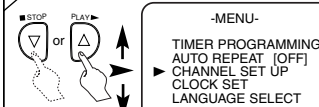

### 3 To decide

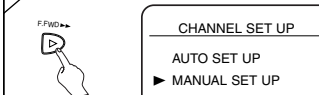

### 4 To exit the menu

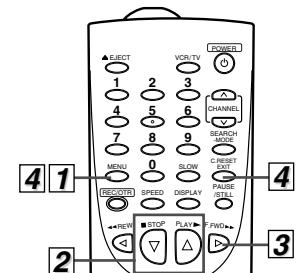
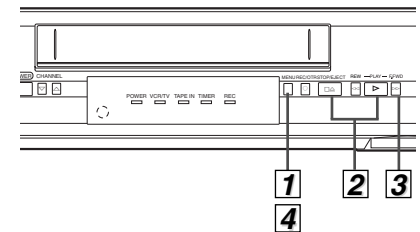
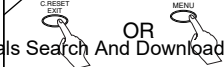

# 9. Recording Features

## Timer Recording

• Insert a tape with its record tab into the VCR.

**1** **-MENU-**  
 MENU  
 ▶ TIMER PROGRAMMING  
 AUTO REPEAT [OFF]  
 CHANNEL SET UP  
 CLOCK SET  
 LANGUAGE SELECT

**2**  
 STOP PLAY  
 PROGRAM NUMBER 4  
 DATE ---:--:--  
 START TIME ---:--:--  
 END TIME ---:--:--  
 CHANNEL ---  
 REC SPEED ---

Select an empty program number

**3**  
 STOP PLAY  
 PROGRAM NUMBER 4  
 ▶ ONCE  
 DAILY  
 WEEKLY

Select "ONCE", "DAILY" (Mon-Fri), or "WEEKLY"

**4** Select the desired month  
 STOP PLAY  
 ONE TIME PROGRAM  
 PROGRAM NUMBER 4  
 DATE 05/03 MON  
 START TIME 07:30 PM  
 END TIME ---:--:--  
 CHANNEL ---  
 REC SPEED ---

Select the desired day  
 STOP PLAY  
 • You can program one year in advance.

**5** Select the desired start time (hour)  
 STOP PLAY  
 ONE TIME PROGRAM  
 PROGRAM NUMBER 4  
 DATE 05/03 MON  
 START TIME 07:30  
 END TIME ---:--:--  
 CHANNEL ---  
 REC SPEED ---

Select the minute

**6**  
 STOP PLAY  
 ONE TIME PROGRAM  
 PROGRAM NUMBER 4  
 DATE 05/03 MON  
 START TIME 07:30  
 END TIME ---:--:--  
 CHANNEL ---  
 REC SPEED ---

Select "AM" or "PM"

**7** Repeat the procedure in steps 5 and 6 to set the end time.

**8**  
 STOP PLAY  
 ONE TIME PROGRAM  
 PROGRAM NUMBER 4  
 DATE 05/03 MON  
 START TIME 07:30 PM  
 END TIME 08:30 PM  
 CHANNEL 6  
 REC SPEED 1

Select the desired channel

• If you have connected the VCR to a cable box or satellite box as the Connection A on page 1, select the VCR to channel 3 or 4 (the RF output channel of the VCR). Then, select the desired channel at the cable box or satellite box. Leave the cable box or satellite box on for timer recording.

**9**  
 STOP PLAY  
 ONE TIME PROGRAM  
 PROGRAM NUMBER 4  
 DATE 05/03 MON  
 START TIME 07:30 PM  
 END TIME 08:30 PM  
 CHANNEL 16  
 REC SPEED SP

Select the desired recording speed

**10** Turn off the VCR for recording  
 POWER

• TIMER indicator on the VCR lights up.

**Hint**  
 • To go back one step, press the REW button (during the steps [3] to [9].)

### To Check, Correct, or Cancel a Timer Program

- 1) Turn the power on by pressing the POWER button.
- 2) Select main menu by pressing the MENU button.
- 3) Select "TIMER PROGRAMMING" by pressing the PLAY or STOP button. Then, press the F.FWD button.
- 4) Select the program number which you want to check by pressing the PLAY or STOP button. The details of the program you selected will appear on the TV screen.
- Go to the digit you want to change by pressing the F.FWD or REW button. Then, enter correct numbers by pressing the PLAY or STOP button.
- You may cancel the entire program by pressing the REW button while the program number flashes.
- 5) Press the C.RESET/EXIT button to exit.
- 6) Press the POWER button to return to timer stand-by mode.

## Hint for Timer Recording

- If there is a power failure or the VCR has been unplugged for more than 30 seconds, the clock setting and all timer settings will be lost.
  - If the tape runs out before the end time, the VCR will switch to the Stop mode immediately, eject the tape and the VCR power will be turned off. The TIMER indicator will flash.
  - If a tape is not in the VCR or does not have the record tab, the TIMER indicator flashes and timer recording cannot be performed. Please insert a recordable tape.
- When all the Timer Recording are completed, the TIMER indicator flashes. To play or eject the recorded tape, press the POWER button first, and then press the PLAY or EJECT button.

To cancel a Timer Recording that is in progress

Press the STOP/EJECT button on the VCR.

## Copying a Video Tape

**Warning:** Unauthorized recordings of copyrighted video tapes may be an infringement of copyright laws.

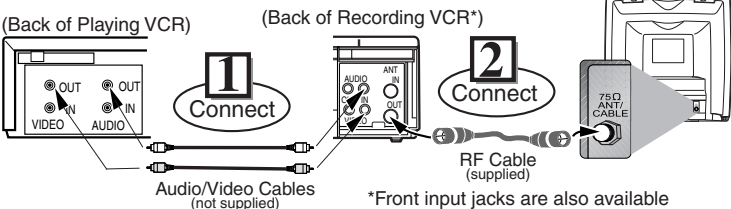

- 1) Insert a pre-recorded tape into the playing VCR.
- 2) Insert a tape with its record tab into the recording VCR.
- 3) Press the SPEED button on the remote control of the recording VCR to select the desired recording speed (SP/SLP).
- 4) Select the "L1" or "L2" position on the recording VCR.
  - To use the input jacks on the back of the VCR, select "L1" position by pressing [0], [0], [1] on the remote control or the CHANNEL buttons.
  - To use the input jacks on the front of the VCR, select "L2" position by pressing [0], [0], [2] on the remote control or the CHANNEL buttons.
- 5) Press the REC/OTR button on the recording VCR.
- 6) Begin playback of the tape in the playing VCR.
- 7) To stop recording, press the STOP/EJECT button on the recording VCR, then stop playback of the tape in the playing VCR.

**Hint**  
 • For best results during dubbing, use the VCR's front panel controls whenever possible. The remote control might affect the playing VCR's operation.  
 • Always use a video-quality shielded cable with RCA-type connectors. Standard audio cables are not recommended.  
 • You can use a video disc player, satellite receiver, or other audio/video component with A/V outputs in place of the playing VCR.  
 • "L1" or "L2" is found before the lowest memorized channel. (Example: CH02)

# 10. Special Features

## Time Search

You can specify the time for fast forwarding or rewinding.

- Insert a tape into the VCR.

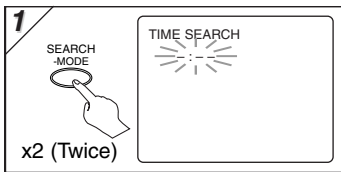

2 Select the desired length of time for fast forwarding or rewinding

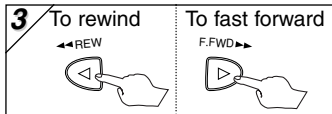
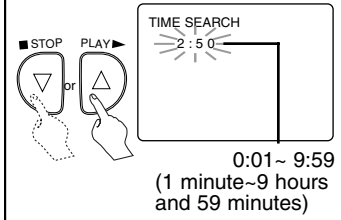

After searching,

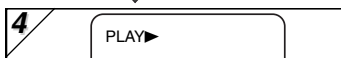

## Index Search

You can specify the number of programs to be skipped.

- Insert a tape into the VCR.

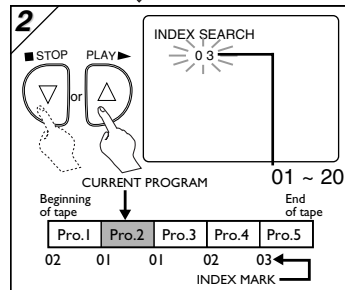
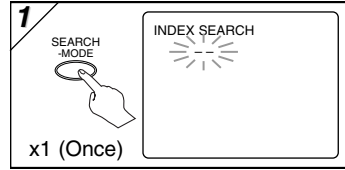

After searching,

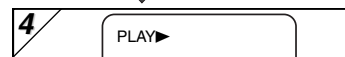

### Hint

- The VCR records an index mark at the beginning of the recording when you make a recording. There should be time gap between index marks for the Index Search.

### Hint for Timer Search & Index Search

- These functions are not available during recording.
- Press the STOP button to stop the search.
- If the end of the tape is reached during a Search, the VCR will cancel the search and rewind the tape.

## Auto Repeat

You can repeat playback of a whole tape automatically.

- Insert a tape into the VCR.

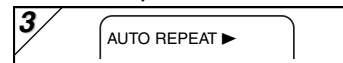
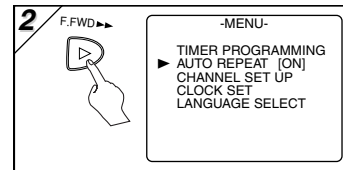
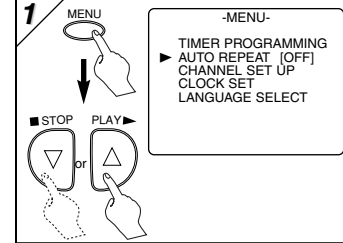

### Hint

- To cancel Auto Repeat, follow steps [1]-[2] above. Then, press the F.FWD button so that [OFF] appears beside AUTO REPEAT. Press the C.RESET/EXIT button to exit.
- If menu remains on the TV screen at step [3], press the C.RESET/EXIT button to exit.

# 11. Information

## SYLVANIA HOME ENTERTAINMENT WARRANTY

We appreciate your purchase of a SYLVANIA Home Entertainment product. We take pride in the quality of our products and have manufactured your new Home Entertainment unit to exacting quality standards. We feel confident that in normal use, it will provide you with satisfactory performance. However, should you experience difficulty, you are protected under the provisions of this warranty. SYLVANIA Home Entertainment products are warranted against manufacturing defects in materials and workmanship in normal use for the following periods from the date of purchase by the original user, and is conditional upon the unit being installed and used as directed in the instruction manual.

Product	Parts and Labour
V.C.R.	1 Year
Video Head	6 Months
Remote Control	90 Days

SYLVANIA's obligation under this warranty shall be limited to the repair, including all necessary parts and the cost of the labour connected therewith, or at our option the exchange of any Home Entertainment product which shows evidence of a manufacturing defect within the warranty period. Replacement parts, furnished in connection with this warranty shall be warranted for a period equal to the unexpired portion of the original equipment warranty.

### CUSTOMER OBLIGATIONS

This warranty applies to the product from the original date of purchase at retail. Therefore, the owner must provide a copy of the original, dated bill of sale. No warranty service will be performed without a bill of sale. Transportation to and from the service depot is the responsibility of the owner.

### WARRANTY EXCLUSIONS

This warranty is extended to SYLVANIA Home Entertainment products purchased and used in Canada. This warranty shall not apply to appearance or accessory items including but not limited to: cabinet, cabinet parts, batteries, connecting cables, tapes. This warranty shall, in addition, not apply to cleaning video/audio heads, pinch rollers, tape transport system damages due to

handling, transportation, unpacking, set-up, installation, customer adjustments that are covered in the instruction book, repair or replacement of parts supplied by other than the SYLVANIA authorized service depot, any malfunction or failure caused by or resulting from abnormal environmental conditions, improper unauthorized service, improper maintenance, modifications or repair by the consumer, abuse, misuse, neglect, accident, fire, flood, or other Acts of God, and incorrect line voltage.

This Home Entertainment product is only warranted to the original retail purchaser. This warranty becomes void in the event of commercial or rental use. This warranty becomes void in the event serial numbers are altered, defaced or removed.

SYLVANIA reserves the right to make changes in design or to make additions to or improvements upon this product without incurring any obligation to install the same on products previously manufactured. The foregoing is in lieu of all other warranties expressed or implied and SYLVANIA neither assumes nor authorizes any person to assume for it any other obligation or liability in connection with the sale or service of this product. In no event shall SYLVANIA or its SYLVANIA dealers be liable for special or consequential damage arising from the use of this product, or for any delay in the performance of this warranty due to cause beyond our control. The purchaser may have other rights under existing provincial or federal laws, and where any terms of this warranty are prohibited by such laws, they are deemed null and void, but the remainder of the warranty shall remain in effect.

### HOW TO OBTAIN SERVICE

Should this product require service, you may obtain specific information on how to obtain service by contacting the SYLVANIA Dealer from whom this product was purchased, or by contacting us directly:

#### SONIGEM SERVICE

300 Alden Road  
Markham, Ontario  
L3R 4C1

PHONE: (905) 940-5089  
FAX: (905) 940-2303  
1-800-287-4871

## Maintenance

### Servicing

Should your VCR become inoperative, do not try to correct the problem by yourself. There are no user-serviceable parts inside. Turn off, unplug the power plug, and please call our help line mentioned on page 1 to locate an Authorized Service Center.

### Cabinet Cleaning

- Wipe the front panel and other exterior surfaces of the VCR with a soft cloth immersed in lukewarm water and wrung dry.
- Never use a solvent or alcohol. Do not spray insecticide liquid near the VCR. Such chemicals may cause damage and discoloration to the exposed surfaces.

### Auto Head Cleaning

- Automatically cleans video heads as you insert or remove a cassette, so you can see a clear picture.
  - Playback picture may become blurred or interrupted while the TV program reception is clear. Dirt accumulated on the video heads after long periods of use, or the usage of rental or worn tapes can cause this problem. If a streaky or snowy picture appears during playback, the video heads in your VCR may need to be cleaned.
- Please visit your local Audio/Video store and purchase a good quality VHS Video Head Cleaner.
  - If a Video Head Cleaner does not solve the problem, please call our help line mentioned on page 1 to locate an Authorized Service Center.

### NOTES:

- Remember to read the instructions included with the video head cleaner before use.
- Clean video heads only when problems occur.

## Instrucciones en Español

### PREPARACIÓN DE CANALES (La antena o la caja de televisión por cable deberá estar conectada)

**NOTES:** Cuando utilice su nueva videograbadora por primera vez, o en el caso de ser necesario después de producirse un fallo en la alimentación, la videograbadora se pondrá inicialmente en el modo de preajuste cuando se pulse [POWER].

- Encienda el televisor y ponga el televisor en el canal 3.
- Pulse [POWER] para encender la videograbadora.
- Seleccione "ENGLISH", "FRANCAIS"(French) o "ESPAÑOL" (Spanish) pulsando [PLAY] o [STOP]. Y luego pulse [F.FWD].
- Pulse una vez [F.FWD].

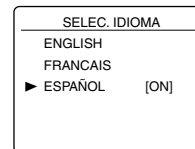

El sintonizador explora y memoriza todos los canales activos de su zona. Tras la exploración, el sintonizador se detiene en el canal memorizado más bajo.

### PREPARACIÓN DEL RELOJ

- Pulse [MENU] hasta que aparezca el menú principal. (Si el reloj no está puesto en hora y se pulsa [MENU], el menú AJUSTE DE RELOJ aparece en primer lugar. En este caso, siga el paso 3.)
- Pulse [PLAY] o [STOP] para indicar a "AJUSTE DE RELOJ". Luego, pulse [F.FWD].
- 

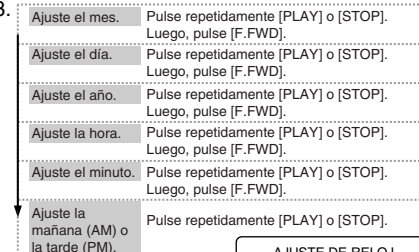

- Para volver atrás un paso, pulse [REW].
- Pulse [F.FWD] para poner en funcionamiento el reloj.

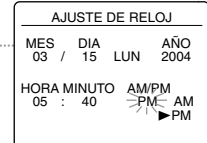



## Free Manuals Download Website

<http://myh66.com>

<http://usermanuals.us>

<http://www.somanuals.com>

<http://www.4manuals.cc>

<http://www.manual-lib.com>

<http://www.404manual.com>

<http://www.luxmanual.com>

<http://aubethermostatmanual.com>

Golf course search by state

<http://golfingnear.com>

Email search by domain

<http://emailbydomain.com>

Auto manuals search

<http://auto.somanuals.com>

TV manuals search

<http://tv.somanuals.com>