

PL360/460 Cradle

Quick Reference Guide



© 2001 - 2006 SYMBOL TECHNOLOGIES, INC. All rights reserved.

Symbol reserves the right to make changes to any product to improve reliability, function, or design.

Symbol does not assume any product liability arising out of, or in connection with, the application or use of any product, circuit, or application described herein.

No license is granted, either expressly or by implication, estoppel, or otherwise under any patent right or patent, covering or relating to any combination, system, apparatus, machine, material, method, or process in which Symbol products might be used. An implied license exists only for equipment, circuits, and subsystems contained in Symbol products.

Symbol and the Symbol logo are registered trademarks of Symbol Technologies, Inc. Other product names mentioned in this manual may be trademarks or registered trademarks of their respective companies and are hereby acknowledged.

Symbol Technologies, Inc.
One Symbol Plaza
Holtsville, N.Y. 11742-1300
<http://www.symbol.com>

Warranty

For the complete Symbol hardware product warranty statement, go to:
<http://www.symbol.com/warranty>.

Patents

This product is covered by one or more patents. For patent information go to:
<http://www.symbol.com/patents>.

Introduction

The PhaserLink 360/460 cradle acts as a stand, host communication interface, and charger for the Phaser scanner. For convenience, the cradle can sit on a desktop or be mounted on a wall.

The cradle receives data from the scanner via connectors in the bottom of the scanner and the top of the cradle. It then transmits that data to the host device through an attached cable.

The cradle also provides power for charging the scanner battery pack (in the scanner). The cradle has a charge status indicator light.

Two versions of the cradle are available:

- PL 460 cradle: the batch retail version.
- PL 360 cradle: the batch industrial version.

This *Quick Reference Guide* provides basic instruction on the set up and use of the cradle. Unless otherwise noted, the term PhaserLink refers to all versions of the cradle.

Equipment Supplied

The following equipment is supplied:

- Two screws (for wall mounting).
- One Velcro strip (for desk mounting).
- Four rubber feet (for desk mounting).
- This Quick Reference Guide.
- PhaserLink cradle.

Save the shipping container for storing or shipping. Inspect all equipment for damage. If anything is damaged or missing, call your authorized Customer Support Representative immediately.

Related Documentation

- Phaser Series Scanner Product Reference Guide, p/n 70-33629-xx.
- P360/460 Memory Scanners Quick Reference Guide, p/n 70-33628-xx.

Parts

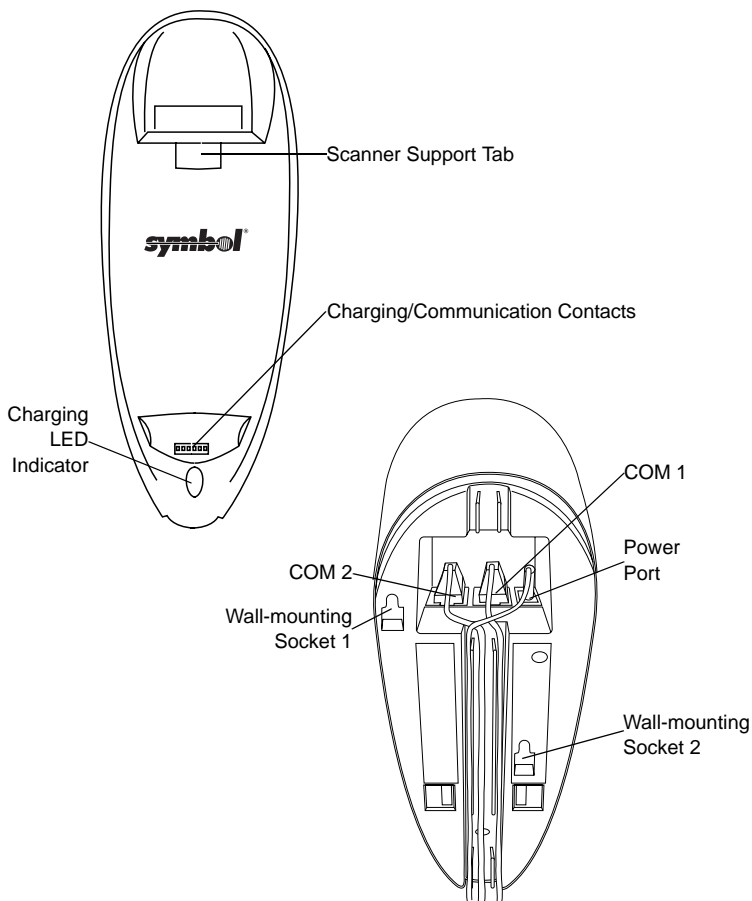

Connecting to the Host

There are three ports on the bottom of the cradle.

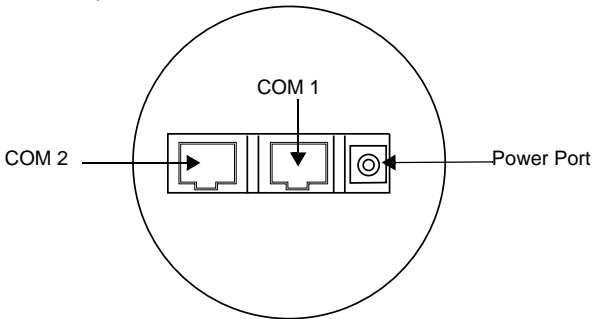

COM 1 connects to the host computer; COM 2 is used for daisy-chaining multiple cradles together; and, the Power Port supplies power to the cradle.

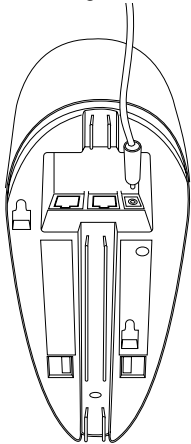

1. Insert the independent power plug into the Power Port. (The cradle cannot be powered by the host computer.)
2. Insert the cable from the host computer into COM 1.
3. Insert the cable to the other cradles, if any, into COM 2.

Daisy-Chaining

- ✓ **NOTE** The cradle supports daisy-chaining when connected to a serial host and not when using Synapse interfaces.

To daisy-chain two or more cradles together, connect COM 1 of the first cradle to the host and COM 2 to COM 1 of the second cradle. Then connect COM 2 of the second cradle to COM 1 of the third cradle. Up to 12 cradles can be daisy-chained to one host.

Wall Mounting

Before wall-mounting the cradle, the scanner support tab must be changed from the desk-mount position to the wall-mount position.

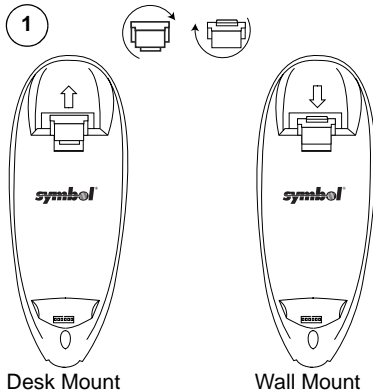

1. Lift the scanner support tab out of the top part of the cradle and replace it in the wall-mount position as shown.
2. Seat the cables from the bottom of the cradle in the grooves along the length of the cradle so that the bottom of the cradle is smooth and flat.
3. Secure two screws (included) to the wall. A template is provided on [page 14](#).
 - Fasten the screws into the wall where the cradle should hang leaving about 1/8" (.3 cm) of the screw outside the wall for the cradle wall mount sockets.
4. Place the cradle over the screw heads and slide down until it fits into place. Slight pressure upwards should not move the cradle.
5. Place the Phaser scanner in the cradle.

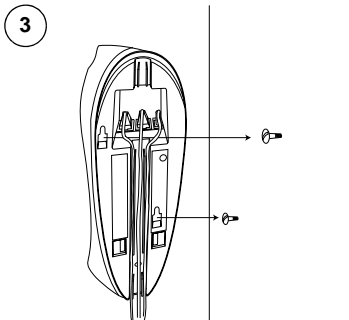
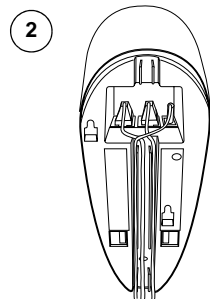

Inserting Phaser in the Cradle

Place the Phaser scanner in the cradle so that the top of the scanner sits in the larger part of the cradle and the metal contacts on the bottom of the scanner touch the contacts on the cradle.

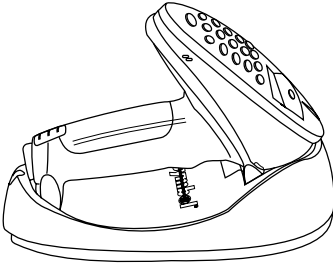

Sending Data to the Host Computer

To set up the PhaserLink cradle for communication between a Phaser scanner and a host computer:

1. Connect the cradle to the host computer as described in [Connecting to the Host on page 5](#).
2. Insert the Phaser scanner in the cradle.
3. Start the communication program on the host computer and the Phaser scanner.

Recharging the Battery in the Phaser

4. Connect the cradle to a receptacle supplying AC power of the proper voltage level.
5. Place the scanner in the cradle, ensuring the metal contacts on the bottom of the scanner touch the contacts on the cradle.
6. A complete charge takes up to 4 hours, depending upon the remaining charge in the scanner battery.

Indicator LED

When the scanner is placed in the cradle, it waits 15 minutes to start charging the battery in the scanner. The LED indicates the charging status as follows:

LED	Description
Off	The scanner is not in the cradle.
Slow Blink	Scanner is in cradle but not charging.
Fast Blink	Scanner is in cradle and charging.
On	Scanner is in cradle and the charge cycle is complete.

Troubleshooting

If the cradle does not work after following the operating instructions in this guide:

- check the system power.
- check for loose cable connections.
- ensure the scanner is sitting properly in the cradle.

Cleaning

Wipe the cradle periodically with a lens tissue or other material suitable for cleaning optical material, such as eyeglasses.



CAUTION Do not pour, spray or spill any liquid on the cradle.

Regulatory Information

All Symbol devices are designed to be compliant with rules and regulations in locations they are sold and are labeled as required.

Any changes or modifications to Symbol Technologies equipment, not expressly approved by Symbol Technologies, could void the user's authority to operate the equipment.



CAUTION Only use Symbol approved and UL Listed accessories, battery packs and battery chargers.

Do NOT attempt to charge damp/wet mobile computers or batteries. All components must be dry before connecting to an external power source.

Country Approvals

Regulatory markings are applied to the device signifying the device is approved for use in the following countries: United States, Canada, Australia, Japan and Europe.

Please refer to the Symbol Declaration of Conformity (DoC) for details of other country markings. This is available at <http://www2.symbol.com/doc/>.



Operation of the device without regulatory approval is illegal.

Health and Safety Recommendations



Ergonomic Recommendations



CAUTION In order to avoid or minimize the potential risk of ergonomic injury follow the recommendations below. Consult with your local Health & Safety Manager to ensure that you are adhering to your company's safety programs to prevent employee injury.

- Reduce or eliminate repetitive motion.
- Maintain a natural position.
- Reduce or eliminate excessive force.
- Keep objects that are used frequently within easy reach.
- Perform tasks at correct heights.

Download from [Www.Somanuals.com](http://www.Somanuals.com). All Manuals Search And Download.

- Reduce or eliminate vibration.
- Reduce or eliminate direct pressure.
- Provide adjustable workstations.
- Provide adequate clearance.
- Provide a suitable working environment.
- Improve work procedures.

Vehicle or Forklift Installation

Position your device within easy reach. Be able to access your device without removing your eyes from the road.



Laser Devices

Complies with 21CFR1040.10 and 1040.11 except for deviations pursuant to Laser Notice No. 50, dated July 26, 2001.

EN60825-1:1994+ A1:2002 +A2:2001

IEC60825-1:1993+A1:1997+A2:2001

The laser classification is marked on one of the labels on the device.

Class 1 Laser devices are not considered to be hazardous when used for their intended purpose. The following statement is required to comply with US and international regulations:



CAUTION Use of controls, adjustments or performance of procedures other than those specified herein may result in hazardous laser light exposure.

Class 2 laser scanners use a low power, visible light diode. As with any very bright light source, such as the sun, the user should avoid staring directly into the light beam. Momentary exposure to a Class 2 laser is not known to be harmful.

Cradle Labeling

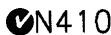
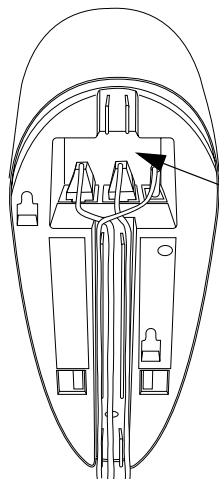

THIS PRODUCT COVERED BY U.S. AND FOREIGN PATENTS.
SEE QUICK REFERENCE GUIDE FOR PATENT LISTING.

THIS DEVICE COMPLIES WITH PART 15 OF THE FCC RULES.
OPERATION IS SUBJECT TO THE FOLLOWING TWO CONDITIONS:
(1) THIS DEVICE MAY NOT CAUSE HARMFUL INTERFERENCE, AND
(2) THIS DEVICE MUST ACCEPT ANY INTERFERENCE RECEIVED,
INCLUDING INTERFERENCE THAT MAY CAUSE UNDESIRABLE OPERATION.
THIS CLASS A DIGITAL APPARATUS MEETS ALL REQUIREMENTS OF
THE CANADIAN INTERFERENCE-Causing EQUIPMENT REGULATIONS.
CET APPAREIL NUMÉRIQUE DE LA CLASSE A RESPECTE TOUTES LES
EXIGENCES DU RÈGLEMENT SUR LE MATÉRIEL BROUILLÉUR DU CANADA
MADE IN U.S.A.

In accordance with Clause 5, IEC 825 and EN60825, the following information is provided to the user:

**ENGLISH**

CLASS 1 CLASS 1 LASER PRODUCT
CLASS 2 LASER LIGHT
DO NOT STARE INTO BEAM
CLASS 2 LASER PRODUCT

HEBREW

מוצר לייזר רמה 1 רמה 1
אור לייזר רמה 2
אין להביט אל תוך הזרם מוצר לייזר רמה 2

DANISH / DANSK

KLASSE 1 KLASSE 1 LASERPRODUKT
KLASSE 2 LASERLYF
SE IKKE IND I STRÅLEN
KLASSE 2 LASERPRODUKT

ITALIAN / ITALIANO

KLASSE 1 PRODOTTO AL LASER DI CLASSE 1
KLASSE 2 LUCE LASER
NON FISSARE IL RAGGIO/PRODOTTO
AL LASER DI CLASSE 2

DUTCH / NEDERLANDS

KLASSE 1 KLASSE-1 LASERPRODUKT
KLASSE 2 LASERLICHT
NIET IN STRAAL STAREN
KLASSE-2 LASERPRODUKT

NORWEGIAN / NORSK

KLASSE 1 LASERPRODUKT, KLASSE 1
KLASSE 2 LASERLYS IKKE STIRR INN I LYSSTRÅLEN
LASERPRODUKT, KLASSE 2

FINNISH / SUOMI

LUOKKA 1 LUOKKA 1 LASERTUOTE
LUOKKA 2 LASERVALO
ÄLÄ TUJOTA SÄDETTÄ
LUOKKA 2 LASERTUOTE

PORTUGUESE / PORTUGUÊS

CLASSE 1 PRODUTO LASER DA CLASSE 1
CLASSE 2 LUZ DE LASER NÃO FIXAR O RAIOS LUMINOSOS
PRODUTO LASER DA CLASSE 2

FRENCH / FRANÇAIS

CLASSE 1 PRODUIT LASER DE CLASSE 1
CLASSE 2 LUMIERE LASER
NE PAS REGARDER LE RAYON FIXEMENT
PRODUIT LASER DE CLASSE 2

SPANISH / ESPAÑOL

CLASE 1 PRODUCTO LASER DE LA CLASE 1
CLASE 2 LUZ LASER
NO MIRE FIJAMENTE EL HAZ
PRODUCTO LASER DE LA CLASE 2

GERMAN / DEUTCH

KLASSE 1 LASERPRODUKT DER KLASSE 1
KLASSE 2 LASERSTRAHLEN
NICHT DIREKT IN DEN LASERSTRAHL SCHAUEN
LASERPRODUKT DER KLASSE 2

SWEDISH / SVENSKA

KLASS 1 LASERPRODUKT KLASS 1
KLASS 2 LASERLJUS STIRRA INTE MOT STRÅLEN
LASERPRODUKT KLASS 2

CHINESE / 简体中文

1 类 1 类激光产品
2 类 激光
切勿注视光束
2 类激光产品

KOREAN / 한국어

1등급 1등급 레이저 제품
2등급 레이저 광선
이 광선을 주시하지 마십시오.
2등급 레이저 제품

JAPANESE / 日本語

クラス1 クラス1 レーザ製品
クラス2 レーザ光線
光線を直視しないでください
クラス2 レーザ製品

Power Supply

Use only a Symbol approved power supply 50-14000-101R output rated 9 Vdc and minimum 1 A. The power supply is certified to EN60950-1 with SELV outputs. Use of an alternative power supply invalidates any approval given to this device and may be dangerous.

Batteries

Please follow the local regulations when disposing of re-chargeable batteries.

Taiwan - Recycling

EPA (Environmental Protection Administration) requires dry battery producing or importing firms in accordance with Article 15 of the Waste Disposal Act are required to

indicate the recycling marks on the batteries used in sales, giveaway or promotion. Contact a qualified Taiwanese recycler for proper battery disposal.



「廢電池請回收」

Symbol Rechargeable Batteries

Symbol rechargeable battery packs are designed and constructed to the highest standards within the industry. However, there are limitations to how long a battery can operate or be stored before needing replacement. Many factors affect the life of a battery pack such as heat, cold, customer usage profiles, age, and severe drops.

When batteries are stored over a year, battery cell manufacturers advise that some irreversible deterioration in overall battery quality may occur. To minimize this loss, they recommend storing batteries half charged in a dry, cool place between 41° and 77°F (5° and 25°C), the cooler the better) and removed from the equipment to prevent the loss of capacity. Batteries should be charged to half capacity at least once a year. If an electrolyte leakage is observed, avoid any contact with the affected area and properly dispose of the battery.

Replace the battery when a significant loss of run time is detected. Batteries must be charged within the 32° to 104°F (0° to 40°C) temperature range.

The standard warranty period for all Symbol batteries is 30 days, regardless if the battery was purchased separately or included as part of the mobile computer. For more information on Symbol batteries, please visit <http://mysymbolcare.symbol.com/battery/batbasics1.html>.

Radio Frequency Interference Requirements-FCC



Note: This equipment was tested and found to comply with the limits for a Class B digital device, pursuant to Part 15 of the FCC rules. These limits are designed to provide reasonable protection against harmful interference in a residential installation. This equipment generates, uses and can

radiate radio frequency energy and, if not installed and used in accordance with the instructions, may cause harmful interference to radio communications. However there is no guarantee that interference will not occur in a particular installation. If this equipment does cause harmful interference to radio or television reception, which can be determined by turning the equipment off and on, the user is encouraged to try to correct the interference by one or more of the following measures:

- Reorient or relocate the receiving antenna.
- Increase the separation between the equipment and receiver.
- Connect the equipment into an outlet on a circuit different from that to which the receiver is connected.
- Consult the dealer or an experienced radio/TV technician for help.

Radio Frequency Interference Requirements - Canada

This Class B digital apparatus complies with Canadian ICES-003.

Cet appareil numérique de la classe B est conforme à la norme NMB-003 du Canada.

Marking and European Economic Area (EEA)

Statement of Compliance

Symbol Technologies, Inc., hereby, declares that this device is in compliance with the essential requirements and other relevant provisions of Directive 1999/5/EC. A Declaration of Conformity may be obtained from <http://www2.symbol.com/doc/>.



Waste Electrical and Electronic Equipment (WEEE)

English: For EU Customers: All products at the end of their life must be returned to Symbol for recycling. For information on how to return product, please go to: http://www.symbol.com/environmental_compliance.

Čeština: Pro zákazníky z EU: Všechny produkty je nutné po skončení jejich životnosti vrátit společnosti Symbol k recyklaci. Informace o způsobu vrácení produktu najdete na webové stránce: http://www.symbol.com/environmental_compliance.

Dansk: Til kunder i EU: Alle produkter skal returneres til Symbol til recirkulering, når de er udtjent. Læs oplysningerne om returnering af produkter på: http://www.symbol.com/environmental_compliance.

Deutsch: Für Kunden innerhalb der EU: Alle Produkte müssen am Ende ihrer Lebensdauer zum Recycling an Symbol zurückgesandt werden. Informationen zur Rücksendung von Produkten finden Sie unter http://www.symbol.com/environmental_compliance.

Eesti: EL klientidele: kõik tooted tuleb nende eluea lõppedes tagastada taaskasutamise eesmärgil Symbol'ile. Lisainformatsiooni saamiseks toote tagastamise kohta külastage palun aadressi: http://www.symbol.com/environmental_compliance.

Español: Para clientes en la Unión Europea: todos los productos deberán entregarse a Symbol al final de su ciclo de vida para que sean reciclados. Si desea más información sobre cómo devolver un producto, visite: http://www.symbol.com/environmental_compliance.

Ελληνικά: Για πελάτες στην Ε.Ε.: Όλα τα προϊόντα, στο τέλος της διάρκειας ζωής τους, πρέπει να επιστρέφονται στην Symbol για ανακύκλωση. Για περισσότερες πληροφορίες σχετικά με την επιστροφή ενός προϊόντος, επισκεφθείτε τη διεύθυνση http://www.symbol.com/environmental_compliance στο Διαδίκτυο.

Français : Clients de l'Union Européenne : Tous les produits en fin de cycle de vie doivent être retournés à Symbol pour recyclage. Pour de plus amples informations sur le retour de produits, consultez : http://www.symbol.com/environmental_compliance.

Italiano: per i clienti dell'UE: tutti i prodotti che sono giunti al termine del rispettivo ciclo di vita devono essere restituiti a Symbol al fine di consentirne il riciclaggio. Per informazioni sulle modalità di restituzione, visitare il seguente sito Web: http://www.symbol.com/environmental_compliance.

Latviešu: ES klientiem: visi produkti pēc to kalpošanas mūža beigām ir jānogādā atpakaļ Symbol otrreizējai pārstrādei. Lai iegūtu informāciju par produktu nogādāšanu Symbol, lūdzu, skatiet: http://www.symbol.com/environmental_compliance.

Lietuvių: ES vartotojams: visi gaminiai, pasibaigus jų eksploatacijos laikui, turi būti gražinti utilizuoti į kompaniją „Symbol“. Daugiau informacijos, kaip gražinti gaminį, rasite: http://www.symbol.com/environmental_compliance.

Magyar: Az EU-ban vásárlóknak: Minden tönkrement terméket a Symbol vállalathoz kell eljuttatni újrahasznosítás céljából. A termék visszajuttatásának módjával kapcsolatos tudnivalóért látogasson el a http://www.symbol.com/environmental_compliance weboldalra.

Malti: Għal klijenti fl-UE: il-prodotti kollha li jkunu waslu fl-aħħar tal-hajja ta' l-użu tagħhom, iridu jiġu rritornati għand Symbol għar-riċiklaġġ. Għal aktar taġġir dwar kif għandek tirritorna l-prodott, jekk jogħġbok żur: http://www.symbol.com/environmental_compliance.

Nederlands: Voor klanten in de EU: alle producten dienen aan het einde van hun levensduur naar Symbol te worden teruggezonden voor recycling. Raadpleeg http://www.symbol.com/environmental_compliance voor meer informatie over het terugzenden van producten.

Polski: Klienci z obszaru Unii Europejskiej: Produkty wycofane z eksploatacji należy zwrócić do firmy Symbol w celu ich utylizacji. Informacje na temat zwrotu produktów znajdują się na stronie internetowej http://www.symbol.com/environmental_compliance.

Português: Para clientes da UE: todos os produtos no fim de vida devem ser devolvidos à Symbol para reciclagem. Para obter informações sobre como devolver o produto, visite: http://www.symbol.com/environmental_compliance.

Slovenski: Za kupce v EU: vsi izdelki se morajo po poteku življenjske dobe vrniti podjetju Symbol za reciklažo. Za informacije o vračilu izdelka obišeite: http://www.symbol.com/environmental_compliance.

Slovenščina: Pre zákazníkov z krajín EU: Všetky výrobky musia byť po uplynutí doby ich životnosti vrátené spoločnosti Symbol na recykláciu. Bližšie informácie o vrátení výrobkov nájdete na: http://www.symbol.com/environmental_compliance.

Suomi: Asiakkaat Euroopan unionin alueella: Kaikki tuotteet on palautettava kierrätettäväksi Symbol-yhtiöön, kun tuotetta ei enää käytetä. Lisätietoja tuotteen palauttamisesta on osoitteessa http://www.symbol.com/environmental_compliance.

Svenska: För kunder inom EU: Alla produkter som uppnått sin livslängd måste returneras till Symbol för återvinning. Information om hur du returnerar produkten finns på http://www.symbol.com/environmental_compliance.

Wall Mounting Template

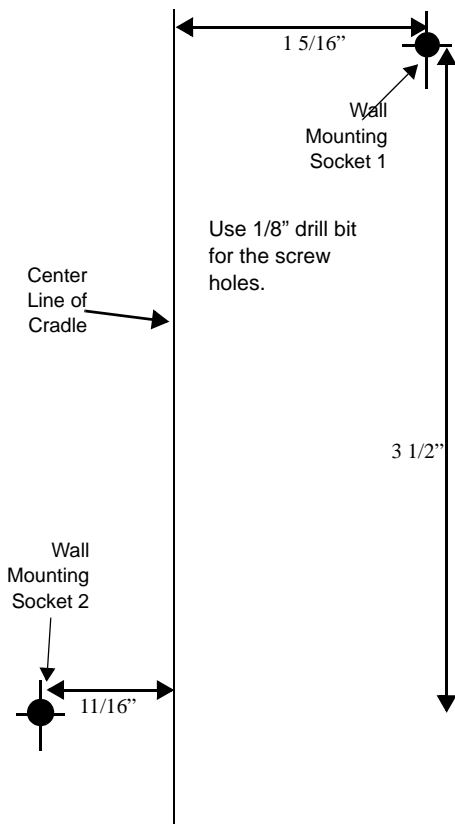

This page is intentionally blank.

Service Information

Before you use the unit, it must be configured to operate in your facility's network and run your applications.

If you have a problem running your unit or using your equipment, contact your facility's Technical or Systems Support. If there is a problem with the equipment, they will contact the Symbol Support Center:

United States	1-800-653-5350	Canada	905-629-7226
United Kingdom	0800 328 2424	Asia/Pacific	337-6588
Australia	1-800-672-906	Austria/Österreich	01-5055794-0
Denmark/Danmark	7020-1718	Finland/Suomi	9 5407 580
France	01-40-96-52-21	Germany/ Deutschland	6074-49020
Italy/Italia	2-484441	Mexico/México	5-520-1835
Netherlands/Nederla nd	315-271700	Norway/Norge	+47 2232 4375
South Africa	11-809 5311	Spain/España	+913244000
Sweden/Sverige	08 445 29 00	Europe/Mid-East Distributor Operations	Contact local distributor or call +44 118 945 7360
Latin America Sales Support	Inside USA: 1-800-347-0178; Outside USA: +1.954.255.2610		

For the latest version of this guide go to: <http://www.symbol.com/manuals>.



70-33657-01

Revision D - May 2006

Symbol Technologies, Inc.

One Symbol Plaza Holtsville, N.Y. 11742-1300

<http://www.symbol.com>

Download from [Www.Somanuals.com](http://www.Somanuals.com). All Manuals Search And Download.

Free Manuals Download Website

<http://myh66.com>

<http://usermanuals.us>

<http://www.somanuals.com>

<http://www.4manuals.cc>

<http://www.manual-lib.com>

<http://www.404manual.com>

<http://www.luxmanual.com>

<http://aubethermostatmanual.com>

Golf course search by state

<http://golfingnear.com>

Email search by domain

<http://emailbydomain.com>

Auto manuals search

<http://auto.somanuals.com>

TV manuals search

<http://tv.somanuals.com>