

# OWNER'S MANUAL

# VIDEO CASSETTE RECORDER VR-501

# Symphonic

## TABLE OF CONTENTS

■ <b>IMPORTANT SAFEGUARDS</b> .....	2
■ <b>PRECAUTIONS</b> .....	3
■ <b>FEATURES</b> .....	4
■ <b>OPERATING CONTROLS AND FUNCTIONS</b> .....	4
■ <b>PREPARATION FOR USE</b> .....	6
■ <b>INITIAL SET UP FOR USE</b> .....	7
■ <b>SET UP FOR USE AGAIN</b> .....	8
■ <b>PLAYBACK FUNCTION</b> .....	9
■ <b>RECORDING FUNCTION</b> .....	10
■ <b>TIMER RECORDING</b> .....	11
■ <b>SPECIAL FEATURES</b> .....	12
■ <b>TROUBLESHOOTING GUIDE</b> .....	12
■ <b>SPECIFICATIONS</b> .....	13
■ <b>MAINTENANCE</b> .....	13
■ <b>INSTRUCCIONES EN ESPAÑOL</b> .....	14
■ <b>WARRANTY</b> .....	16

**INSTRUCCIONES EN ESPAÑOL INCLUIDAS.**

## SUPPLIED ACCESSORIES

ACCESSORIES	PART NO.
Coaxial Cable	WPZ0901LW001
Remote Control Unit	N9374UD or N9377UD
Batteries	AA x 2

 As an ENERGY STAR® Partner, our company has determined that this product meets the ENERGY STAR® guidelines for energy efficiency. ENERGY STAR® is a U.S. registered mark.

**VHS**

If you need additional operating assistance after reading this owner's manual or to order replacement accessories, please call  
**TOLL FREE : 1-800-242-7158.**

**WARNING:** TO REDUCE THE RISK OF FIRE OR ELECTRIC SHOCK,  
DO NOT EXPOSE THIS APPLIANCE TO RAIN OR MOISTURE.



**CAUTION**  
RISK OF ELECTRIC SHOCK  
DO NOT OPEN



**CAUTION:** TO REDUCE THE RISK OF ELECTRIC SHOCK, DO NOT REMOVE COVER (OR BACK). NO USER SERVICEABLE PARTS INSIDE. REFER SERVICING TO QUALIFIED SERVICE PERSONNEL.

The caution marking is located on the rear of the cabinet.



The lightning flash with arrowhead symbol, within an equilateral triangle, is intended to alert the user to the presence of uninsulated "dangerous voltage" within the product's enclosure that may be of sufficient magnitude to constitute a risk of electric shock to persons.



The exclamation point within an equilateral triangle is intended to alert the user to the presence of important operating and maintenance (servicing) instructions in the literature accompanying the product.

## IMPORTANT SAFEGUARDS

- 1. Read Instructions-**All the safety and operating instructions should be read before the appliance is operated.
- 2. Retain Instructions-**The safety and operating instructions should be retained for future reference.
- 3. Heed Warnings-**All warnings on the appliance and in the operating instructions should be adhered to.
- 4. Follow Instructions-**All operating and use instructions should be followed.
- 5. Cleaning-**Unplug this video product from the wall outlet before cleaning. Do not use liquid cleaners or aerosol cleaners. Use a damp cloth for cleaning.

**EXCEPTION :** A product that is meant for uninterrupted service and, that for some specific reason, such as the possibility of the loss of an authorization code for a CATV converter, is not intended to be unplugged by the user for cleaning or any other purpose, may exclude the reference to unplugging the appliance in the cleaning description otherwise required in item 5.

- 6. Attachments-**Do not use attachments not recommended by the video product manufacturer as they may cause hazards.
- 7. Water and Moisture-**Do not use this video product near water, for example, near a bath tub, wash bowl, kitchen sink, or laundry tub, in a wet basement, or near a swimming pool, and the like.
- 8. Accessories-**Do not place this video product on an unstable cart, stand, tripod, bracket, or table. The video product may fall, causing serious injury to a child or adult, and serious damage to the appliance.

PORTABLE CART WARNING  
(Symbol provided by IRETAG)



S3125A

- 9. Ventilation-**Slots and openings in the cabinet are provided for ventilation and to ensure reliable operation of the video product and to protect it from overheating, and these openings must not be blocked or covered. The openings should never be blocked by placing the video product on a bed, sofa, rug, or other similar surface. This video product should not be placed in a built-in installation such as a bookcase or rack unless proper ventilation is provided or the manufacturer's instructions have been adhered to.
- 10. Power Sources-**This video product should be operated only from the type of power source indicated on the marking label. If you are not sure of the type of power supply to your home, consult your appliance dealer or local power company. For products intended to operate from battery power, or other sources, refer to the operating instructions.
- 11. Grounding or Polarization-** This video product is equipped with a polarized alternating-current line plug (a plug having one blade wider than the other). This plug will fit into the power outlet only one way. This is a safety feature. If you are unable to insert the plug fully into the outlet, try reversing the plug. If the plug should still fail to fit, contact your electrician to replace your obsolete outlet. Do not defeat the safety purpose of the polarized plug.
- 12. Power Cord Protection-**Power supply cords should be routed so that they are not likely to be walked on or pinched by items placed upon or against them, paying particular attention to cords at plugs, convenience receptacles, and the point where they exit from the appliance.
- 13. Outdoor Antenna Grounding-**If an outside antenna or cable system is connected to the video product, be sure the antenna or cable system is grounded so as to provide some protection against voltage surges and built-up static charges. Article 810 of the National Electrical Code, ANSI/NFPA No. 70, provides information with regard to proper grounding of the mast and supporting structure, grounding of the lead-in wire to an antenna discharge unit, size of grounding conductors, location of antenna-discharge unit, connection to grounding electrodes, and requirements for the grounding electrode. (Fig. A)

FIGURE A  
EXAMPLE OF ANTENNA GROUNDING AS PER  
NATIONAL ELECTRICAL CODE

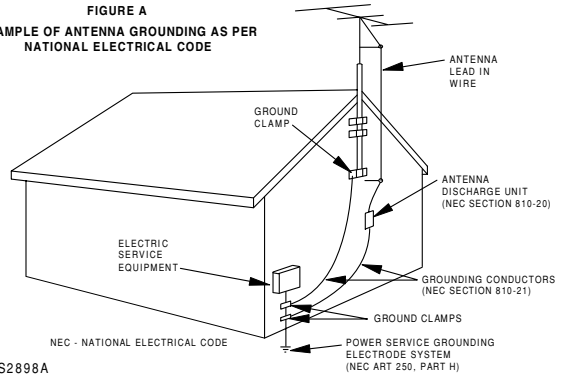

S2898A

- 14. Lightning-**For added protection for this video product during a lightning storm, or when it is left unattended and unused for long periods of time, unplug it from the wall outlet and disconnect the antenna or cable system. This will prevent damage to the video product due to lightning and power-line surges.
- 15. Power Lines-**An outside antenna system should not be located in the vicinity of overhead power lines or other electric light or power circuits, or where it can fall into such power lines or circuits. When installing an outside antenna system, extreme care should be taken to keep from touching such power lines or circuits as contact with them might be fatal.
- 16. Overloading-**Do not overload wall outlets and extension cords as this can result in a risk of fire or electric shock.
- 17. Object and Liquid Entry-**Never push objects of any kind into this video product through any openings as they may touch dangerous voltage points or short-out parts that could result in a fire or electric shock. Never spill liquid of any kind on the video product.
- 18. Servicing-**Do not attempt to service this video product yourself as opening or removing covers may expose you to dangerous voltage or other hazards. Refer all servicing to qualified service personnel.
- 19. Damage Requiring Service-**Unplug this video product from the wall outlet and refer servicing to qualified service personnel under the following conditions:
  - When the power-supply cord or plug is damaged.
  - If liquid has been spilled, or objects have fallen into the video product.
  - If the video product has been exposed to rain or water.
  - If the video product does not operate normally by following the operating instructions. Adjust only those controls that are covered by the operating instructions as an improper adjustment of other controls may result in damage and will often require extensive work by a qualified technician to restore the video product to its normal operation.
  - If the video product has been dropped or damaged in any way.
  - When the video product exhibits a distinct change in performance-this indicates a need for service.
- 20. Replacement Parts-**When replacement parts are required, be sure the service technician has used replacement parts specified by the manufacturer or have the same characteristics as the original part. Unauthorized substitutions may result in fire, electric shock or other hazards.
- 21. Safety Check-**Upon completion of any service or repairs to this video product, ask the service technician to perform safety checks to determine that the video product is in proper operating condition.
- 22. Heat-**This video product should be situated away from heat sources such as radiators, heat registers, stoves, or other products (including amplifiers) that produce heat.

# PRECAUTIONS

## INSTALL LOCATION

For safety and optimum performance of your VCR:

- Install the VCR in a horizontal and stable position. Do not place anything directly on top of the VCR. Do not place the VCR directly on top of the TV.
- Shield it from direct sunlight and keep it away from sources of intense heat. Avoid dusty or humid places. Avoid places with insufficient ventilation for proper heat dissipation. Do not block the ventilation holes on the sides of the VCR. Avoid locations subject to strong vibration or strong magnetic fields.

## AVOID THE HAZARDS OF ELECTRICAL SHOCK AND FIRE

- Do not handle the power cord with wet hands.
- Do not pull on the power cord when disconnecting it from AC wall outlet. Grasp it by the plug.
- If, by accident, water is spilled on your VCR, unplug the power cord immediately and take the unit to our Authorized Service Center for servicing.
- Do not put your fingers or objects into the VCR cassette holder.

## MOISTURE CONDENSATION WARNING

Moisture condensation may occur inside the unit when it is moved from a cold place to a warm place, or after heating a cold room or under conditions of high humidity. Do not use the VCR at least for 2 hours until its inside is dry.

## VIDEO CASSETTE TAPE

- This VCR will operate with any cassette that has the **VHS** mark. For best results, we recommend the use of high-quality tapes. Do not use poor quality or damaged tapes.
- Avoid moisture. Moisture condensation may occur on the tape if it is moved from a cold place to a warm place or visa versa. Before using a tape with these conditions, to avoid damage of the tape and your VCR, wait until the tape has warmed to room temperature and the moisture has evaporated.
- Avoid extreme heat, high humidity and magnetic fields.
- Do not tamper with the cassette mechanism.
- Do not touch the tape with your fingers.
- You can prevent accidental erasing of a recording by breaking off the tab on the back edge of the cassette.
- If you decide to record on the tape again, cover the hole with plastic tape.

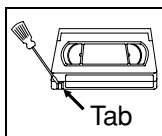

## REMOTE CONTROL

We do not recommend the use of universal remote controls. Not all of the functions may be controlled with a universal remote control.

If you decide to use a universal remote control with this unit, please be aware that the code number given may not operate this unit. In this case, please call the manufacturer of the universal remote control.

## FCC WARNING

This equipment may generate or use radio frequency energy. Changes or modifications to this equipment may cause harmful interference unless the modifications are expressly approved in the instruction manual. The user could lose the authority to operate this equipment if an unauthorized change or modification is made.

## IMPORTANT COPYRIGHT INFORMATION

Unauthorized recording or use of broadcast television programming, video tape, film or other copyrighted material may violate applicable copyright laws. We assume no responsibility for the unauthorized duplication, use, or other acts which infringe upon the rights of copyright owners.

## A NOTE ABOUT RECYCLING

This product's packaging materials are recyclable and can be reused. Please dispose of any materials in accordance with your local recycling regulations.

Batteries should never be thrown away or incinerated but disposed of in accordance with your local regulations concerning chemical wastes.

## SERIAL NUMBER

The serial number of this product may be found on the back of the VCR. No other VCR has the same serial number as yours. You should record the number and other vital information here and retain this book as a permanent record of your purchase to aid identification in case of theft. Serial numbers are not kept on file.

Date of Purchase	
Dealer Purchase from	
Dealer Address	
Dealer Phone No.	
Model No.	
Serial No.	

**CAUTION: TO PREVENT ELECTRIC SHOCK, MATCH WIDE BLADE OF PLUG TO WIDE SLOT, FULLY INSERT.**

**ATTENTION: POUR ÉVITER LES CHOC ÉLECTRIQUES, INTRODUIRE LA LAME LA PLUS LARGE DE LA FICHE DANS LA BORNE CORRESPONDANTE DE LA PRISE ET POUSSER JUSQU'AU FOND.**

# FEATURES

## Hardware specifications

- **Auto Head Cleaner**
- **4 Head**
- **Bilingual on-screen menu display selectable in English or Spanish**
- **181 channel capability PLL frequency synthesizer tuner with direct station call**  
(A cable converter box may be necessary to view scrambled cable channels.)

## Automatic functions

- **Auto power on and off system**
- **Digital Auto Tracking (DTR)**

## Playback

- **S-VHS Quasi Playback (SQPB)**  
(Allows you to view a tape recorded in S-VHS format.)
- **Auto Repeat**
- **2 Step Picture Search Operation**
- **Index Search**
- **Time Search**

## Recording

- **1 Year, 7 events (including Daily and Weekly Timer Recording)**
- **OTR (One Touch Recording)**

# OPERATING CONTROLS AND FUNCTIONS

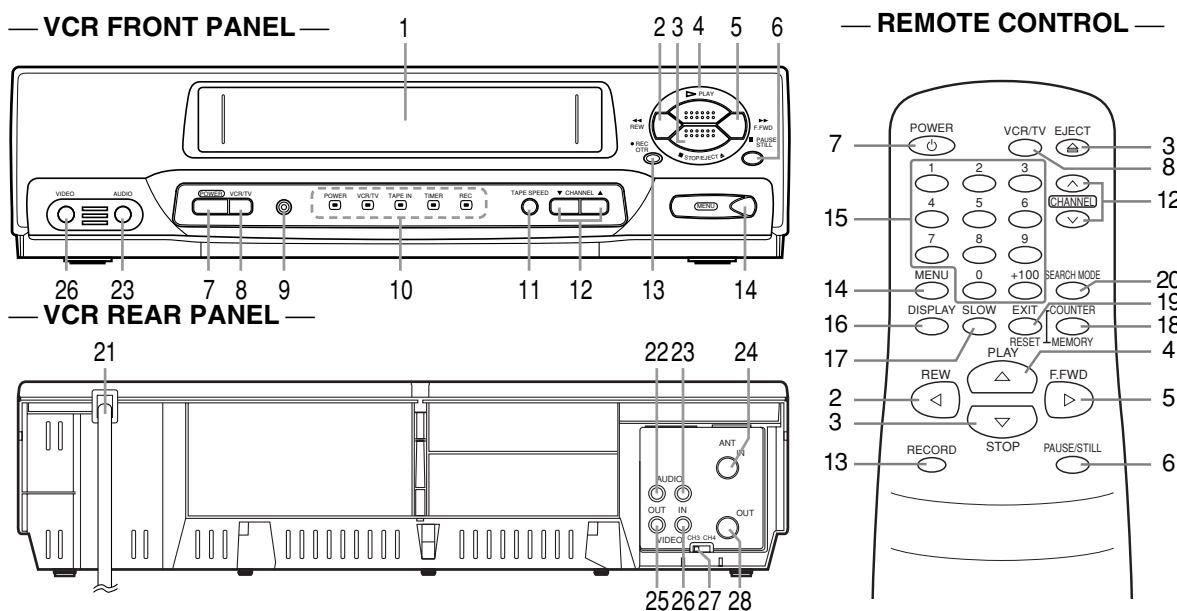

### 1. Cassette Compartment

**2. REW button**— Press to rewind the tape, or to view the picture rapidly in reverse during the playback mode. (Rewind Search)

Press to cancel a setting of timer program. Press to correct digits when setting program (For example: setting clock or timer program). Press to add or delete channel numbers during channel preset.

**3. EJECT button**— Press to remove the tape from the VCR.

**STOP button**— Press to stop the tape motion. Press to enter digits when setting program (For example: setting clock or timer program). Press to select the setting modes from the on screen menu.

**4. PLAY button**— Press to begin playback.

Press to enter digits when setting program (For example: setting clock or timer program). Press to select the setting modes from the on screen menu.

**5. F.FWD button**— Press to rapidly advance the tape, or view the picture rapidly in forward during playback. (Forward Search)

When setting program (For example: setting clock or timer program), press to determine your selection and proceed to the next step you want to input. Press to determine the setting modes from the on screen menu. Press to add or delete channel numbers during channel preset.

- 6. PAUSE/STILL button**– Press to temporarily stop the tape during recording or to view a still picture during playback.
- Frame Advance function**– Press to advance the picture by one frame at a time during still mode.
- 7. POWER button**– Press to turn VCR on and off. Press to activate timer recording, when the timer program has been set.
- 8. VCR/TV button**– Press to select TV or VCR mode.
- VCR position:* to view playback, to monitor video recordings or watch TV using the VCR tuner.
- TV position:* to watch TV or to view one program while recording another.
- 9. Remote sensor window**– Receives the infrared signals from the remote control.
- 10. Indicators**
- POWER indicator**– Indicates that the power is turned on.
- VCR/TV indicator**– Indicates that the VCR is in the VCR position.
- TAPE IN indicator**– Indicates that there is a tape in the VCR.
- TIMER indicator**– Indicates that the timer recording or OTR has been set.
- REC indicator**– Indicates that it is recording. Flashes when a recording has been paused.
- 11. TAPE SPEED button**– Press to choose the desired recording speed : SP/SLP. (only on the VCR)
- 12. CHANNEL Up or Down buttons**– Press to select the desired channels for viewing or recording.
- Tracking function**– Press to minimize video ‘noise’ (lines or dots on screen) during playback (only on the VCR) or slow mode.
- Press to stabilize the picture in the Still mode when the picture begins to vibrate vertically.
- 13. RECORD button**– Press for manual recording.
- OTR button**– Press to activate One Touch Recording. (only on the VCR)
- 14. MENU button**– Press to display the menu on the TV screen. Press to exit the menu on the TV screen.
- 15. NUMBER buttons**– Press to select desired channels for viewing or recording. To select channels from 1 to 9, first press "0" button then 1 to 9. (only on the remote control)
- +100 button**– When selecting cable channels which are higher than 99, press this button first, then press the last two digits. (To select channel 125, first press "+100" button then press "2" and "5"). (only on the remote control)
- 16. DISPLAY button**– Press to display the current time, channel number, real time tape counter, and other information on the TV screen. (only on the remote control)
- Each time you press this button, TV screen will change as shown. The status display (STOP, PLAY etc.) and the tape speed display (SP, LP (playback only), or SLP) will disappear after 5 seconds.

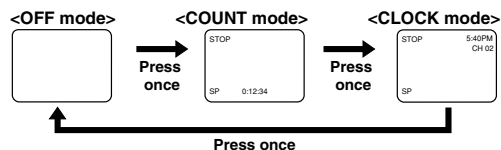

- 17. SLOW button**– Press to start slow motion playback. (only on the remote control)
- 18. COUNTER MEMORY button**– Press to set counter memory on and off. (only on the remote control)
- 19. COUNTER RESET button**– Press to reset counter to 0:00:00. (only on the remote control)
- EXIT button**– Press to exit the menu on the TV screen. (only on the remote control)
- 20. SEARCH MODE button**– Press to perform a Time Search or an Index Search. (only on the remote control)
- 21. Power cord**– Connect to a standard AC outlet (120V/60Hz).
- 22. AUDIO OUT jack**– Connect to the audio input jack of your audio equipment or another VCR.
- 23. AUDIO IN jack**– Connect to the audio output jack of your audio equipment or another VCR.
- 24. ANT. IN terminal**– Connect to an antenna, Cable system or Satellite system.
- 25. VIDEO OUT jack**– Connect to the video input jack of your video camera or another VCR.
- 26. VIDEO IN jack**– Connect to the video output jack of your video camera or another VCR.
- 27. CH3/CH4 selector switch**– Use to select a video output channel (3 or 4) for VCR playback.
- 28. ANT. OUT terminal**– Connects to the antenna input terminal on your TV.

## INSTALLING THE BATTERIES

- 1) Open the battery compartment cover by pressing the cover on the remote unit in the direction of the arrow.
- 2) Insert 2 "AA" penlight batteries into the battery compartment in the direction indicated by the polarity (+/-) markings.
- 3) Replace the cover.

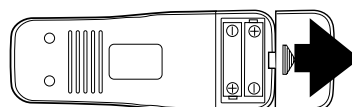

Install 2 X AA battery

# PREPARATION FOR USE

## ANTENNA/CABLE CONNECTIONS

For some of the most common types of connections, please refer to the diagram below. Use only one connection. For any further complex connections, please contact your local dealer. (You may need additional accessories which are not supplied).

**1** Disconnect the antenna or cable from your TV.

**2** Connect the antenna or cable to the ANT.IN (Top jack) of your VCR.

**3** Connect one end of the coaxial cable (supplied) to the ANT.OUT (Bottom jack) of your VCR.

**4** Connect the other end of the coaxial cable (supplied) to the UHF/VHF antenna jack of your TV.

### Basic Connections

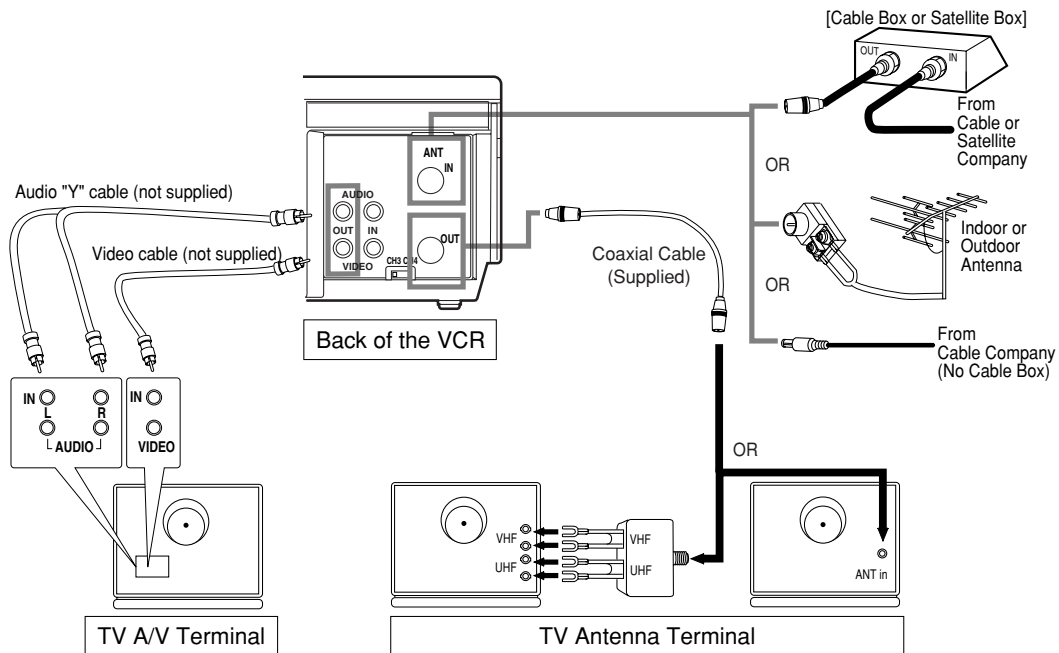

### USING OPTIONAL AUDIO/VIDEO OUTPUT JACKS

If your TV has A/V input jacks, you may connect your VCR's AUDIO/VIDEO OUTPUT jacks to the audio/video input jacks on back of your TV.

Direct audio/video connections usually result in a better picture and sound quality for tape playback. Please see your TV's owner's manual for A/V input connections.

### USING AUDIO/VIDEO INPUT JACKS

You can use the A/V input jacks on the front or the back of the VCR.

- 1) When you connect the external source to input jacks on the back of the VCR, select "L1" position for recording by pressing the 0, 0, 1 on the remote control or CHANNEL Up/Down button.
- 2) When you connect the external source to input jacks on the front of the VCR, select "L2" position for recording by pressing the 0, 0, 2 on the remote control or CHANNEL Up/Down button.

**Note:** "L1" or "L2" is found before the lowest memorized channel. (Example: CH2)

### Note to CATV system installer

This reminder is provided to call the CATV system installer's attention to Article 820-40 of the NEC that provides guidelines for proper grounding and, in particular, specifies that the cable ground shall be connected to the grounding system of the building, as close to the point of cable entry as practical.

# INITIAL SET UP FOR USE

## SETTING THE CH3/CH4 SWITCH

*If your TV does not have A/V terminals:*

When the VCR is in the Playback mode or when the VCR is in the VCR position, your TV will receive signals from the VCR on either channel 3 or 4.

To use the VCR with your TV, set the selector switch to CH3 or CH4 (which is located in the back of your VCR), whichever is not used for normal broadcasts in your area. Then set your TV to the same channel.

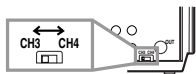

[Back of the VCR]

## AUTOMATIC CHANNEL SET UP

You can automatically program the tuner to scan only the channels you receive in your area.

- Channel memory programming is **NOT needed** when you connected the VCR to a cable box or satellite box as in "Basic connections" on page 6. In this case, select the VCR and TV to channel 3 or 4 the same channel as the CH3 or CH4 switch on the back of the VCR. Then, the channel you want to record or view may be selected at the cable box or satellite box.
- Follow the steps below once. Repeat it only if there is a power failure or if the VCR is unplugged for more than 30 seconds. (In these cases, the programmed channels are erased.)
- You must follow the steps below before attempting to play or record a video tape. If you want to play or record a video tape BEFORE programming the tuner, you can cancel it by pressing the RESET/EXIT button. To program the tuner again, see "CHANNEL SET UP AGAIN" on the next page.

**1** You need to connect the antenna or cable to the VCR first. Then, connect the VCR power plug into a standard AC outlet.

**2** Turn on the TV and set the TV to channel 3 or 4. Now set the CH3/CH4 switch on the back of the VCR to match the channel selected on the TV.

**3** Turn on the VCR by pressing the POWER button. Both the POWER indicator and the VCR/TV indicator on the VCR come on.

**4** Select the On Screen Language ("ENGLISH" or "ESPAÑOL") by pressing the PLAY or STOP button. Then, press the F.FWD button.

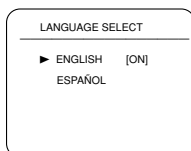

## 5 Begin channel preset

by pressing the F.FWD button once. The tuner scans and memorizes all active channels in your area.

- The VCR distinguishes between standard TV channels and cable channels.

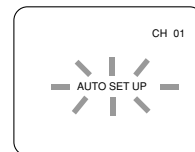

**6** After scanning, the tuner stops on the lowest memorized channel. The TV screen returns to TV mode.

- If "AUTO SET UP" appears on the TV screen again, check the cable connections. Press the F.FWD button once again and the VCR will begin preset again.

## TO SELECT A DESIRED CHANNEL

You can select the desired channel by using the CHANNEL Up or Down button or directly pressing the number buttons on the remote control.

**Note for using the number buttons:**

- When selecting cable channels which are higher than 99, press the +100 button first, then press the last two digits.
- You must precede single-digit channel numbers with a zero (For example: 02, 03, 04 and so on).

## CLOCK SET UP

Set the clock accurately for proper automatic timer recording. We suggest that you use a TV or radio station as your time source.

**1** Select main menu by pressing the MENU button. (If the clock is not set, the CLOCK SET menu appears first. In this case, follow step [3].)

**2** Select "CLOCK SET" by pressing the PLAY or STOP button. Then, press the F.FWD button.

**3** Set the clock.

Set the month	Press the PLAY or STOP button repeatedly. Then, press the F.FWD button.
Set the day	Press the PLAY or STOP button repeatedly. Then, press the F.FWD button.
Set the year	Press the PLAY or STOP button repeatedly. Then, press the F.FWD button. The day of the week will appear automatically.
Set the hour	Press the PLAY or STOP button repeatedly. Then, press the F.FWD button.
Set the minute	Press the PLAY or STOP button repeatedly. Then, press the F.FWD button.
Set the AM or PM	Press the PLAY or STOP button repeatedly.



- To go back one step, press the REW button.

**4** Start the clock by pressing the RESET/EXIT or F.FWD button after setting the AM or PM.

# SET UP FOR USE AGAIN

## TO ADD/DELETE CHANNELS

When the VCR automatically programs the tuner to scan only the channels you receive in your area, some channels may be skipped due to a weak signal. You can manually add the channel in the VCR memory. (Of course, you can later delete the added channel from the memory again.)

**1** Select main menu by pressing the MENU button.

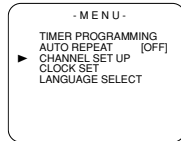

**2** Select "CHANNEL SET UP" by pressing the PLAY or STOP button. Then, press the F.FWD button.

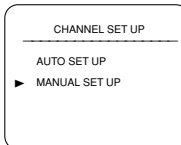

**3** Select "MANUAL SET UP" by pressing the PLAY or STOP button. Then, press the F.FWD button.

**4** Enter the desired channel number by pressing the PLAY or STOP button.

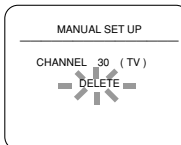

**5** Add or Delete it from memory by pressing the F.FWD or REW button so that "ADD" or "DELETE" flashes on the TV screen accordingly.

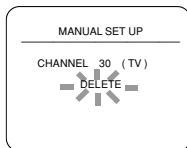

- DELETED -

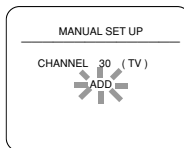

- MEMORIZED -

**6** Exit the preset mode by pressing the RESET/EXIT button.

## CHANNEL SET UP AGAIN

**1** Select main menu by pressing the MENU button.

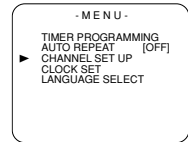

**2** Select "CHANNEL SET UP" by pressing the PLAY or STOP button. Then, press the F.FWD button.

**3** Select "AUTO SET UP" by pressing the PLAY or STOP button. Then, press the F.FWD button. After scanning, the tuner stops at the lowest memorized channel.

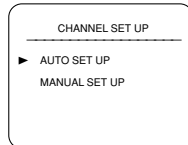

- The VCR distinguishes between standard TV channels and cable channels.

## SELECTING THE ON SCREEN LANGUAGE

**1** Select main menu by pressing the MENU button.

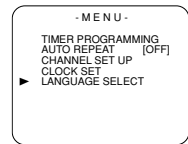

**2** Select "LANGUAGE SELECT" by pressing the PLAY or STOP button. Then, press the F.FWD button.

**3** Select the On Screen Language ("ENGLISH" or "ESPAÑOL") by pressing the PLAY or STOP button.



**4** Exit the preset mode by pressing the RESET/EXIT button.



# PLAYBACK FUNCTION

## NORMAL PLAYBACK

**1 Insert the prerecorded tape.** The VCR will turn on. If the safety tab has been removed, the VCR will start playback automatically.

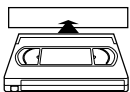

**2 Turn on the TV and set the TV to channel 3 or 4.** Now set the CH3/CH4 switch on the back of the VCR to match the channel selected on the TV.

**3 Begin playback** by pressing the PLAY button.

- Tracking adjustment will be set automatically (Digital Tracking function) when you start playback. To adjust the tracking manually, press the CHANNEL Up or Down button **on the VCR**.
- When a tape has reached the end, the VCR will rewind the tape to the beginning, eject the tape, and turn off the VCR automatically.
- S-VHS Quasi Playback (SQPB)  
This unit allows you to view a tape recorded in S-VHS format. (Noise lines may appear on the picture.)

**4 To stop playback,** press the STOP button.

## STILL/SLOW

- 1) You can freeze the picture on TV screen by pressing the PAUSE/STILL button during playback.
- You can advance the picture by one frame at a time by pressing the PAUSE/STILL button during the still mode.
- 2) You can see the slow motion by pressing the SLOW button during playback or the still mode.
  - If the noise bar appears on the TV screen, you can reduce it by pressing the CHANNEL Up or Down button.
  - After the VCR has been in Still/Slow mode for 5 minutes, it will stop automatically to protect the tape and the video head.
  - To return playback, press the PLAY button.

## AUTO REPEAT PLAYBACK

Use this feature allows you to play a tape over and over.

- 1) Select main menu by pressing the MENU button.
- 2) Select "AUTO REPEAT" by pressing the PLAY or STOP button.
- 3) Begin auto repeat playback by pressing the F.FWD button so that [ON] will appear next to "AUTO REPEAT" on the TV screen.
  - If the on-screen menu still remains, press the RESET/EXIT button to exit the menu.
  - To cancel the auto repeat mode, press the F.FWD button at step [3] so that [OFF] appear next to "AUTO REPEAT" on the TV screen.
  - When you set the auto repeat mode to [ON] while the counter memory mode is ON, the VCR will exit the counter memory mode automatically.

## SEARCH FUNCTIONS

### PICTURE SEARCH

If you want to skip or repeat a scene while in the play mode, press the F.FWD or REW button.

- Press it again and the VCR will now search in super high speed. (in the LP / SLP modes only)

### TIME SEARCH

You can skip a program for a desired length of time.

- 1) Press the SEARCH MODE button so that the Time Search menu appears.
- 2) Enter your desired time to skip by pressing the PLAY or STOP button within 30 seconds.
- 3) Press the F.FWD or REW button to start time search. If you want to go in the forward direction, press the F.FWD button. If you want to go in the reverse direction, press the REW button.
  - After time search, the VCR will play the tape automatically.



### INDEX SEARCH

The index signal is recorded on the tape automatically when the recording is started. If you want to view a recording at a specific start point, it can easily be done.

- 1) Press the SEARCH MODE button so that the Index Search menu appears.
- 2) Enter your desired number by pressing the PLAY or STOP button within 30 seconds.
- 3) Press the F.FWD or REW button to start index search. If you want to go in the forward direction, press the F.FWD button. If you want to go in the reverse direction, press the REW button.
  - After index search, the VCR will play the tape automatically.



# RECORDING FUNCTION

## Before recording, make sure:

- The desired channel is selected by pressing the number buttons on the remote control or the CHANNEL Up/Down button. (If you connected the VCR to a cable box or satellite box as in "Basic connections" on page 6, select the VCR to channel 3 or 4 the same channel as the CH3 or CH4 switch on the back of the VCR. Then, select the channel you want to record at the cable box or satellite box. In this case, you can ONLY record and view the SAME channel.)
- There is a tape with its safety tab into the VCR.
- The desired recording speed is selected in SP(standard play) or SLP(super long play) mode by pressing the TAPE SPEED button on the VCR.

Tape Speed	Recording/Playback Time		
	Type of tape	T60	T120
SP mode	1 hour	2 hours	2-2/3 hours
SLP mode	3 hours	6 hours	8 hours

## VIEWING AND RECORDING THE SAME PROGRAM

- 1) Begin the recording by pressing the RECORD button.
  - To temporarily stop recording or resume it, press the PAUSE/STILL button. After the VCR has been in Pause mode for 5 minutes, it will stop automatically to protect the tape and the video head.
- 2) Stop the recording by pressing the STOP button when recording is completed.

## OTR(One Touch Recording)

This function enables you to set the recording length simply by pressing the REC/OTR button **on the VCR**.

- 1) Begin OTR by pressing the REC/OTR button **on the VCR** repeatedly until the desired recording length appears.
  - Recording stops when 0:00 is reached.

Press	Display	Recorded Length
1 press		(normal recording)
2 presses	0:30	30 minutes
3 presses	1:00	60 minutes
↓	↓	↓
17 presses	8:00	480 minutes
18 presses		(normal recording)

## COPYING A VIDEO TAPE

You can make copies of video tapes made by friends or relatives for your enjoyment.

**Warning:** Unauthorized recordings of copyrighted video tapes may be an infringement of copyright laws. Connect the recording VCR(this unit), the playing VCR(another source) and your TV using the following diagram.

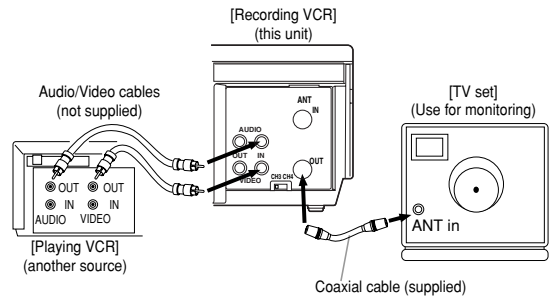

- 1) Insert a pre-recorded tape into the playing VCR.
- 2) Insert a tape with its safety tab into the recording VCR.
- 3) Press the TAPE SPEED button on the recording VCR to select the desired recording speed (SP/SLP).
- 4) Select the "L1" or "L2" position on the recording VCR. See page 6, under "Using audio/video input jacks".
- 5) Press the REC/OTR button on the recording VCR.
- 6) Begin playback of the tape in the playing VCR.
  - For best results during dubbing, use the VCR's front panel controls whenever possible. The remote control might affect the playing VCR's operation.
  - Always use video-quality shielded cables with RCA-type connectors. Standard audio cables are not recommended.
  - You can use a video disc player, satellite receiver, or other audio/video component with A/V outputs in place of the playing VCR.

## TO MONITOR THE RECORDING

- 1) Turn on the TV and set the TV to channel 3 or 4. Now set the CH3/CH4 switch on the back of the VCR to match the channel selected on the TV.
- 2) Press the VCR/TV button on the recording VCR so that the VCR/TV indicator comes on.

# TIMER RECORDING

You may set the VCR to start recording while you are away. You can set seven programs to record on specific days, daily or weekly within a 1 year period.

- 1) Insert a tape with its safety tab into the VCR.
- 2) Select main menu by pressing the MENU button.
- 3) Select "TIMER PROGRAMMING" by pressing the PLAY or STOP button. Then, press the F.FWD button.
  - If you have not yet set the clock, "CLOCK SET" appears. If so, follow the steps [3] and [4] in "CLOCK SET UP" section. Then, set the timer recording.
- 4) Set the timer.

**Set the program number (1~7)**

Program number which is not set up flashes. Press the PLAY or STOP button repeatedly for the desired program number. Then, press the F.FWD button.

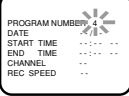

**Select once, daily or weekly recording**

- **For once:** Press the PLAY or STOP button to point to "ONCE".
- **For daily (Monday~Friday):** Press the PLAY or STOP button to point to "DAILY".
- **For weekly:** Press the PLAY or STOP button to point to "WEEKLY". Then, press the F.FWD button.



**Set the date**

First, press the PLAY or STOP button for the month, then, press the F.FWD button. Next, press the PLAY or STOP button for the day. Then, press the F.FWD button.

**Set the start time**

First, press the PLAY or STOP button for the hour, then, press the F.FWD button. Next, press the PLAY or STOP button for the minute, then, press the F.FWD button. And then, press the PLAY or STOP button for AM or PM. Then, press the F.FWD button.

**Set the end time**

Follow the instructions of "Set the start time" to set the end time.

**Set the channel number**

Press the PLAY or STOP button repeatedly for the desired channel number. Then, press the F.FWD button.

- If you connected the VCR to a cable box or satellite box as in "Basic connections" on page 6, select the VCR to channel 3 or 4 the same channel as the CH3 or CH4 switch on the back of the VCR. Then, select the channel you want to record at the cable box or satellite box. Leave the cable box or satellite box on for timer recording.

**Set the tape speed**

Press the PLAY or STOP button repeatedly for the desired tape speed. Then, press the F.FWD button.

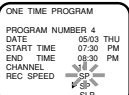

- To go back one step, press the REW button.
- 5) To set another program, repeat step [4]. To exit, press the RESET/EXIT button.
  - 6) Press the POWER button to set the timer. The TIMER indicator on the VCR comes on.

## HINTS FOR TIMER RECORDING

- If there is a power failure or the VCR is unplugged for more than 30 seconds, the clock setting and all timer settings will be lost.
- If the tape runs out before the end time, the VCR will switch to the Stop mode immediately, eject the tape and the VCR power will be turned off. The TIMER indicator will flash.
- If a tape is not in the VCR or does not have the safety tab, the TIMER indicator flashes and timer recording cannot be performed. Please insert a recordable tape.

### TO STOP AN AUTOMATIC TIMER PROGRAM ALREADY STARTED

Press the STOP/EJECT button **on the VCR**.

### TO CHECK, CORRECT, OR CANCEL AN AUTOMATIC TIMER PROGRAM

- 1) Turn the power on.
- 2) Select main menu by pressing the MENU button.
- 3) Select "TIMER PROGRAMMING" by pressing the PLAY or STOP button. Then, press the F.FWD button.
- 4) Select the program number which you want to check by pressing the PLAY or STOP button. The details of the selected program appears on the TV screen.
  - Go to the digit you want to change by pressing the F.FWD or REW button. Then, enter correct numbers by pressing the PLAY or STOP button.
  - You may cancel the entire program by pressing the REW button during the program number flashes.
- 5) Press the RESET/EXIT button to exit.
- 6) Press the POWER button to return to timer stand-by mode.

### AVOIDING OVERLAPPING PROGRAMS

There may be times when a program will not record. When programs overlap:

- The program with the earliest start time has priority.
- Once the earliest program finishes, the overlapping program with the lower number will begin recording in sequence.
- The illustration below demonstrates the sequence of recordings.

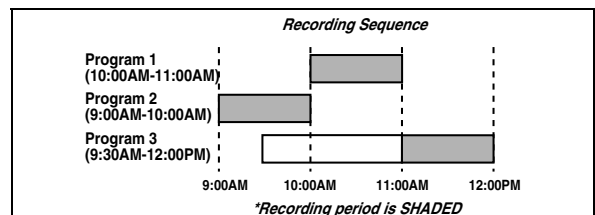

## SPECIAL FEATURES

### AUTO REWIND

When a tape has reached the end during recording, playback, or fast-forward, the tape will automatically rewind to the beginning. After rewinding finishes, the VCR will eject the tape and turn itself to off.

- The tape will not auto-rewind during timer recording or One Touch Recording.
- When the Counter Memory is activated, the tape will rewind to the M0:00:00 and the VCR will go into the Stop mode.

### REAL TIME TAPE COUNTER

- This shows the elapsed recording or playback time in hours, minutes, and seconds. (The displayed time will not change during blank portions on the tape.)
- The "-" indication will appear when the tape is re-wound further than "0:00:00" on the tape counter.

### COUNTER MEMORY FUNCTION

Use this feature to memorize the beginning of recording start point.

- 1) Press the COUNTER RESET button on the remote control to reset the counter.
- 2) Press the COUNTER MEMORY button on the remote control so that "M" appears on the TV screen.
- 3) Record the program.
- 4) After recording, press the STOP button then the REW button.
  - When "0:00:00" is reached, rewinding operation goes to stop. And you can view the recording program.
  - The COUNTER MEMORY button does not function if the auto repeat mode is set to [ON]. In this case, set the auto repeat mode to [OFF].
  - To cancel the counter memory mode, press the COUNTER MEMORY button so that "M" disappears from the TV screen.

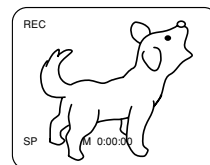

## TROUBLESHOOTING GUIDE

If you have followed the instructions contained in this manual and have difficulty in operating your VCR, locate the PROBLEM in the left column below. Check the corresponding CORRECTIVE ACTION column to remedy the problem.

PROBLEM	CORRECTIVE ACTION
No power.	<ul style="list-style-type: none"> <li>• Make sure the power plug is connected to an AC outlet.</li> <li>• Make sure the power is turned on.</li> </ul>
Timer recording is not possible.	<ul style="list-style-type: none"> <li>• Make sure the timer recording is set correctly.</li> <li>• Make sure the power is off.</li> <li>• Make sure the VCR clock is set correctly.</li> </ul>
Cannot go into Record mode.	<ul style="list-style-type: none"> <li>• Make sure the tape has a safety tab. If needed, cover the hole with plastic tape.</li> </ul>
Playback picture is partially noisy.	<ul style="list-style-type: none"> <li>• Adjust tracking control for a better picture by pressing the CHANNEL Up or Down button on the VCR.</li> </ul>
Cannot view a tape but the audio is OK.	<ul style="list-style-type: none"> <li>• Head cleaning may be necessary. Refer to "AUTO HEAD CLEANING".</li> <li>• Make sure the VCR is not in the Menu mode.</li> </ul>
No picture or poor picture on playback.	<ul style="list-style-type: none"> <li>• Set your TV to the VCR mode and/or press the VCR/TV button so that the VCR/TV indicator on the VCR comes on.</li> <li>• Fine tune your TV.</li> </ul>
On-the-air TV programs cannot be seen.	<ul style="list-style-type: none"> <li>• Re-check the ANT. IN and ANT. OUT connections. See page 6.</li> <li>• Set your TV to the TV mode and/or press the VCR/TV button so that the VCR/TV indicator on the VCR disappears.</li> </ul>
No VCR operation from the infrared Remote Control.	<ul style="list-style-type: none"> <li>• Make sure the power plug is connected to an AC outlet.</li> <li>• Check batteries in remote control.</li> </ul>
Video or color fades in and out when making a copy of a video tape.	<ul style="list-style-type: none"> <li>• You cannot copy a copyrighted video tape. You are experiencing copy guard protection.</li> </ul>

# SPECIFICATIONS

---

Television system :	NTSC, TV standard	Video output level :	1Vp-p
Video heads :	Rotary four-head	Video output impedance :	75Ω
Tape cassette :	<b>VHS</b> video cassette	Audio output level :	-6dBv (1KHz)
Tape speed		Video input level :	0.5~2.0Vp-p
Recording :	SP, SLP	Audio input level :	-10dBv
Playback :	SP, LP, SLP	Power requirement :	120V, 60Hz
Tuner channel		Power consumption :	12 Watts
VHF :	#2~#13	Dimensions :	W 14-1/4" (360mm)
UHF :	#14~#69	H	3-5/8" (92mm)
Cable channel :	5A, A-5 ~ A-1, A ~ W+84	D	8-1/2" (215.5mm)
RF converter :	Built-in VHF converter	Weight :	5.1 lbs. (2.3 Kg.) (approx.)
Converter output :	VHF Channel 3 or 4.		
Timer indication :	AM/PM 12-hour system		
Operating temperature :	5°C~40°C (41°F~104°F)		
Terminals			
Antenna input :	F type connector x 1		
Antenna output :	F type connector x 1		
Video input/output :	RCA connector x 3		
Audio input/output :	RCA connector x 3		

- Designs and specifications are subject to change without notice and without legal obligation.
- If there is a discrepancy between languages, the default language will be English.

# MAINTENANCE

---

## SERVICING

Should your VCR become inoperative, do not try to correct the problem by yourself. There are no user-serviceable parts inside. Turn off, unplug the power plug, and please call our help line at 1-800-242-7158, to locate an Authorized Service Center.

## CABINET CLEANING

- Wipe the front panel and other exterior surfaces of the VCR with a soft cloth immersed in lukewarm water and wrung dry.
- Never use a solvent or alcohol. Do not spray insecticide liquid near the VCR. Such chemicals may cause damage and discoloration to the exposed surfaces.

## AUTO HEAD CLEANING

- Automatically cleans video heads as you insert or remove a cassette, so you can see a clear picture.
- Playback picture may become blurred or interrupted while the TV program reception is clear. Dirt accumulated on the video heads after long periods of use, or the usage of rental or worn tapes can cause this problem.

If a streaky or snowy picture appears during playback, the video heads in your VCR may need to be cleaned.

1. Please visit your local Audio/Video store and purchase a good quality VHS Video Head Cleaner.
2. If a Video Head Cleaner does not solve the problem, please call our help line at 1-800-242-7158, to locate an Authorized Service Center.

## NOTES:

- Remember to read the instructions included with the video head cleaner before use.
- Clean video heads only when problems occur.

## CONEXIONES DE ANTENA/TELEVISIÓN POR CABLE

Para conocer algunos de los tipos de conexión más comunes, consulte las explicaciones siguientes. Utilice solamente una conexión. Para hacer conexiones más complejas, consulte a su concesionario local. (Tal vez necesite accesorios adicionales que no han sido incluidos.)

**NOTA:** Para obtener más información, consulte la sección "Conexiones de antena/televisión por cable" en la página 6.

1. Desconecte la antena o la caja de televisión por cable de su televisor.
2. Conecte la antena o la caja de televisión por cable a ANT.IN (toma superior) de su videogradora.

3. Conecte un extremo del cable coaxial (suministrado) a ANT.OUT (toma inferior) de su videogradora.
4. Conecte el otro extremo del cable coaxial (suministrado) a la toma de antena UHF/VHF de su televisor.
5. Si su televisor no tiene terminales A/V: Ponga el conmutador selector en CH3 o CH4 (en la parte trasera de su videogradora), el que no se utilice para las emisiones normales en su zona. Luego ajuste el televisor al mismo canal.



[Parte trasera de la videogradora]

### Conexiones básicas

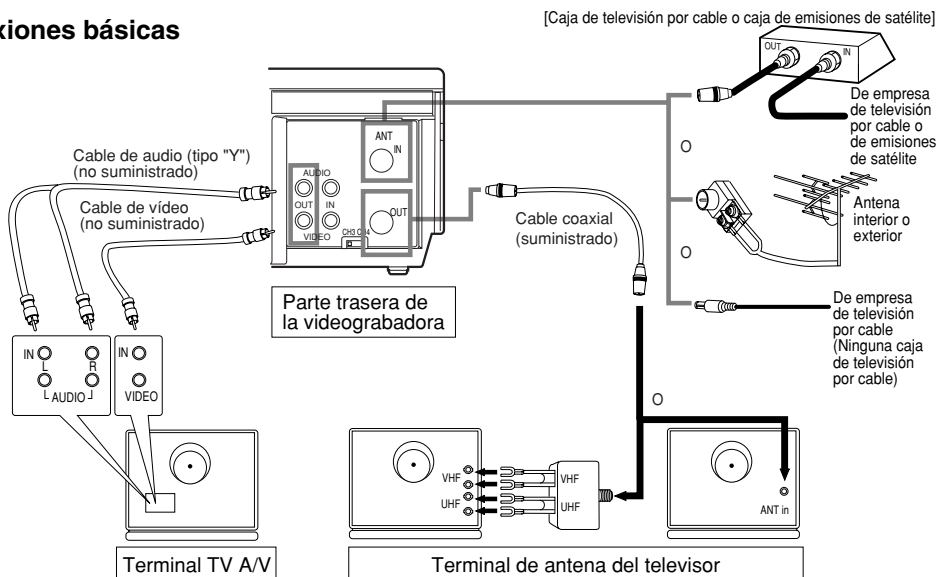

## PREPARACIÓN DE CANALES (La antena o la caja de televisión por cable deberá estar conectada)

**NOTA:** Cuando utilice su nueva videogradora por primera vez, o en el caso de ser necesario después de producirse un fallo en la alimentación, la videogradora se pondrá inicialmente en el modo de preajuste cuando se pulse el botón POWER.

Si conecta una caja de televisión por cable o una caja de emisiones vía satélite, consulte la sección "Preparación automática de canales" del manual del propietario.

1. Encienda el televisor y ponga el televisor en el canal 3 ó 4. Ahora ponga el conmutador de la parte trasera de la videogradora para que concuerde con el canal seleccionado en el televisor.
2. Pulse el botón POWER para encender la videogradora.
3. Seleccione "ENGLISH" o "ESPAÑOL" (Spanish) pulsando el botón PLAY o STOP. Y luego pulse el botón F.FWD.
4. Pulse una vez el botón F.FWD.

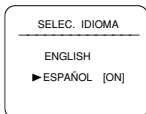

El sintonizador explora y memoriza todos los canales activos de su zona. Tras la exploración, el sintonizador se detiene en el canal memorizado más bajo.

## PREPARACIÓN DEL RELOJ

1. Pulse el botón MENU hasta que aparezca el menú principal. (Si el reloj no está puesto en hora y se pulsa el botón MENU, el menú AJUSTE DE RELOJ aparece en primer lugar. En este caso, siga el paso 3.)
2. Pulse el botón PLAY o STOP para indicar a "AJUSTE DE RELOJ". Luego, pulse el botón F.FWD.

Ajuste el mes.	Pulse repetidamente el botón PLAY o STOP. Luego, pulse el botón F.FWD.
Ajuste el día.	Pulse repetidamente el botón PLAY o STOP. Luego, pulse el botón F.FWD.
Ajuste el año.	Pulse repetidamente el botón PLAY o STOP. Luego, pulse el botón F.FWD.
Ajuste la ora.	Pulse repetidamente el botón PLAY o STOP. Luego, pulse el botón F.FWD.
Ajuste el minuto.	Pulse repetidamente el botón PLAY o STOP. Luego, pulse el botón F.FWD.
Ajuste la mañana (AM) o la tarde (PM).	Pulse repetidamente el botón PLAY o STOP.

AJUSTE DE RELOJ

MES	DIA	AÑO
03	19	LUN 2001
HORA	MINUTO	AM/PM
05	: 40	AM

- Para volver atrás un paso, pulse el botón REW.
4. Después de establecer AM o PM, pulse el botón RESET/EXIT o F.FWD para poner en funcionamiento el reloj.

# CONTROLES DE FUNCIONAMIENTO Y FUNCIONES

## — PANEL DELANTERO DE LA VIDEOGRABADORA —

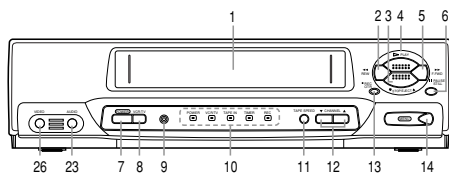

## — PANEL TRASERO DE LA VIDEOGRABADORA —

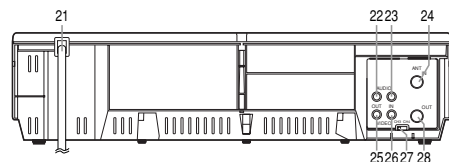

## — MANDO A DISTANCIA —

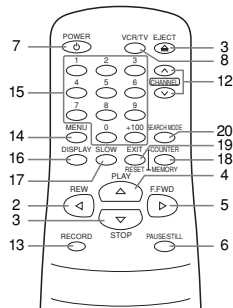

1. **Compartimiento del videocasete**
2. **Botón de rebobinado (REW)** - Púlselo para rebobinar la cinta o para ver rápidamente la imagen en retroceso durante el modo de reproducción. (Búsqueda con rebobinado)  
Púlselo para cancelar un ajuste de programa de temporizador. Púlselo para corregir los dígitos al programar (por ejemplo: puesta en hora del reloj o un programa de temporizador). Púlselo para añadir o borrar números de canales durante el preajuste de canales.
3. **Botón de expulsión (EJECT)** - Púlselo para sacar el videocasete de la videograbadora.  
**Botón de parada (STOP)** - Púlselo para detener la cinta. Púlselo para introducir los dígitos cuando establezca programas (por ejemplo: puesta en hora del reloj o un programa de temporizador). Púlselo para seleccionar los modos de ajuste en el menú en pantalla.
4. **Botón de reproducción (PLAY)** - Púlselo para iniciar la reproducción. Púlselo para introducir los dígitos cuando establezca programas (por ejemplo: puesta en hora del reloj o un programa de temporizador). Púlselo para seleccionar los modos de ajuste en el menú en pantalla.
5. **Botón de avance rápido (F.FWD)** - Púlselo para avanzar rápidamente la cinta o para ver rápidamente la imagen en avance durante la reproducción. (Búsqueda en avance)  
Cuando establezca un programa (por ejemplo: puesta en hora del reloj o un programa de temporizador), púlselo para determinar su selección y proseguir con el siguiente paso que desee introducir. Púlselo para determinar los modos de ajuste del menú en pantalla. Púlselo para añadir o borrar números de canales durante el preajuste de canales.
6. **Botón de pausa/imagen fija (PAUSE/STILL)** - Púlselo para detener temporalmente la cinta durante la grabación o para ver una imagen fija durante la reproducción.  
**Función de avance de cuadro** - Púlselo para avanzar la imagen cuadro a cuadro durante el modo de imagen fija.
7. **Botón de la alimentación (POWER)** - Púlselo para encender y apagar la videograbadora. Púlselo para activar la grabación con temporizador cuando ésta haya sido establecida.
8. **Botón de videograbadora/televisor (VCR/TV)** - Púlselo para seleccionar el modo de la videograbadora (VCR) o del televisor (TV).  
*Posición VCR:* para ver la reproducción, comprobar las grabaciones de vídeo o ver programas de TV utilizando el sintonizador de la videograbadora.  
*Posición TV:* para ver programas de TV o para ver un programa mientras se graba otro.
9. **Ventanilla sensora del mando a distancia** - Recibe las señales infrarrojas procedentes del mando a distancia.
10. **Indicadores**  
**Indicador de alimentación (POWER)** - Indica que la alimentación está conectada.  
**Indicador de videograbadora/televisor (VCR/TV)** - Indica que la videograbadora está activada.  
**Indicador de videocasete introducido (TAPE IN)** - Indica que hay un videocasete en la videograbadora.  
**Indicador del temporizador (TIMER)** - Indica que ha sido establecida la grabación con temporizador u OTR.  
**Indicador de grabación (REC)** - Indica que la videograbadora está grabando. Parpadea cuando la grabación ha hecho una pausa.
11. **Botón de velocidad de cinta (TAPE SPEED)** - Púlselo para elegir la velocidad de grabación deseada: SP/SLP. (Sólo en la videograbadora)
12. **Botones de selección de canales (CHANNEL)** - Púlselos para seleccionar los canales deseados para ver o grabar.  
**Función de seguimiento** - Pulse los botones para minimizar el "ruido" de vídeo (líneas o puntos en la pantalla) durante la reproducción (sólo en la videograbadora) o el modo de cámara lenta. Púlselo para estabilizar la imagen en el modo de imagen fija cuando ésta empieza a vibrar verticalmente.
13. **Botón de grabación (RECORD)** - Púlselo para realizar la grabación manual.  
**Botón de grabación con un toque (OTR)** - Púlselo para activar la grabación con un toque. (Sólo en la videograbadora)
14. **Botón de menús (MENU)** - Púlselo para visualizar los menús en la pantalla del televisor. Y vuelva a pulsarlo para salir de los menús de la pantalla del televisor.
15. **Botones de números (NUMBER)** - Púlselos para seleccionar los canales deseados para ver o grabar. Para seleccionar los canales del 1 al 9, pulse primero el botón "0" y luego el botón 1 a 9. (Sólo en el mando a distancia)  
**Botón +100** - Cuando seleccione canales de televisión por cable cuyo número sea superior al 99, pulse primero este botón, y luego pulse los dos últimos dígitos. (Para seleccionar el canal 125, pulse primero el botón "+100" y luego el "2" y el "5"). (Sólo en el mando a distancia)
16. **Botón del visualizador (DISPLAY)** - Púlselo para visualizar en la pantalla del televisor la hora actual, el número del canal, el contador de cinta en tiempo real y otra información. (Sólo en el mando a distancia)  
Cada vez que pulse este botón, la pantalla del televisor cambiará. La visualización del estado (PARAR, REPRODUCIR, etc.) y la visualización de velocidad de la cinta [SP, LP (reproducción solamente) o SLP] desaparecerá después de 5 segundos.
17. **Botón de cámara lenta (SLOW)** - Púlselo para iniciar la reproducción de cámara lenta. (Sólo en el mando a distancia)
18. **Botón de memoria del contador (COUNTER MEMORY)** - Púlselo para activar y desactivar la memoria del contador. (Sólo en el mando a distancia)
19. **Botón de reposición del contador (COUNTER RESET)** - Púlselo para reponer el contador a 0:00:00. (Sólo en el mando a distancia)  
**Botón de salida (EXIT)** - Púlselo para salir de los menús en pantalla. (Sólo en el mando a distancia)
20. **Botón del modo de búsqueda (SEARCH MODE)** - Púlselo para realizar una búsqueda con tiempo o una búsqueda con índice. (Sólo en el mando a distancia)
21. **Cable de alimentación** - Conéctelo a una toma de CA estándar (120 V/60 Hz).
22. **Toma de salida de audio (AUDIO OUT)** - Conéctela a la toma de entrada de audio de su equipo de audio o de otra videograbadora.
23. **Toma de entrada de audio (AUDIO IN)** - Conéctela a la toma de salida de audio de su equipo de audio o de otra videograbadora.
24. **Terminal de entrada de antena (ANT. IN)** - Aquí se conecta una antena, sistema de televisión por cable o sistema de emisiones vía satélite.
25. **Toma de salida de vídeo (VIDEO OUT)** - Conéctela a la toma de entrada de vídeo de su videocámara o de otra videograbadora.
26. **Toma de entrada de vídeo (VIDEO IN)** - Conéctela a la toma de salida de vídeo de su videocámara o de otra videograbadora.
27. **Conmutador selector de canales CH3/CH4** - Se utiliza para seleccionar un canal de salida de vídeo (3 ó 4) para la reproducción de la videograbadora.
28. **Terminal de salida de antena (ANT. OUT)** - Conéctelo al terminal de entrada de la antena de su televisor.

# FUNAI CORPORATION

## LIMITED WARRANTY

Funai Corporation will exchange or repair this product, at its option, in the event of defect in materials or workmanship as follows:

### EXCHANGE DURATION:

**1-90 DAYS:** FUNAI CORPORATION will exchange for a new unit without charge for a period of ninety (90) days from the date of original retail purchase.

**91-365 DAYS:** FUNAI CORPORATION will exchange for a factory-service-to-new-condition unit for a charge of \$49.00 for the period of ninety one (91) days to three hundred sixty five (365) days from the date of original retail purchase.

### REPAIR DURATION:

**LABOR:** FUNAI CORPORATION will provide the labor without charge for a period of ninety (90) days from the date of original retail purchase.

**PARTS:** FUNAI CORPORATION will provide parts to replace defective parts without charge for a period of one (1) year from the date of original retail purchase. Two (2) years for Picture Tube. Certain parts are excluded from this warranty.

### LIMITS AND EXCLUSIONS:

This warranty is extended only to the original retail purchaser. A purchase receipt or other proof of original retail purchase will be required together with the product to obtain exchange or service under this warranty.

This warranty shall not be extended to any other person or transferee.

This warranty is void and of no effect if any serial numbers on the product are altered, replaced, defaced or missing. This FUNAI CORPORATION Limited warranty applies only to product purchased and used in the United States.

This warranty only covers failures due to defects in material or workmanship, which occur during normal use. It does not cover damage which occurs in shipment, or failures which are caused by repairs, alterations, or parts not supplied by FUNAI CORPORATION, or damage which results from accident, misuse, abuse, mishandling, misapplication, alteration, faulty installation, improper maintenance, commercial use such as hotel, rental or office use of this product, or damage which results from fire, flood, lightning or other acts of God.

THIS WARRANTY DOES NOT COVER PACKING MATERIALS, ANY ACCESSORIES (EXCEPT REMOTE CONTROL UNITS), ANY COSMETIC PARTS, COMPLETE ASSEMBLY PARTS, DEMONSTRATION OR FLOOR MODELS. FUNAI CORPORATION AND ITS REPRESENTATIVES OR AGENTS SHALL IN NO EVENT BE LIABLE FOR ANY GENERAL, INDIRECT OR CONSEQUENTIAL DAMAGES ARISING OUT OF OR OCCASIONED BY THE USE OF OR THE INABILITY TO USE THIS PRODUCT. THIS WARRANTY IS MADE IN LIEU OF ALL OTHER WARRANTIES INCLUDING THE WARRANTY OF MERCHANT ABILITY, AND FITNESS FOR A PARTICULAR PURPOSE, THAT ARE HEREBY DISCLAIMED BY FUNAI CORPORATION AND ITS REPRESENTATIVES OR AGENTS IN THE UNITED STATES.

ALL WARRANTY INSPECTIONS AND REPAIRS MUST BE PERFORMED BY A FUNAI AUTHORIZED CENTER. THIS WARRANTY IS VALID WHEN THE PRODUCT IS DELIVERED PREPAID TO A FUNAI AUTHORIZED SERVICE FACILITY.

### IMPORTANT:

THIS LIMITED WARRANTY GIVES YOU SPECIFIC LEGAL RIGHTS, YOU MAY HAVE OTHER RIGHTS THAT VARY FROM STATE TO STATE. IF AT ANY TIME DURING THE WARRANTY PERIOD YOU ARE UNABLE TO OBTAIN SATISFACTION WITH THE EXCHANGE OR REPAIR OF THIS PRODUCT, PLEASE CONTACT FUNAI CORPORATION.

### ATTENTION:

FUNAI CORPORATION RESERVES THE RIGHT TO MODIFY ANY DESIGN OF THIS PRODUCT WITHOUT PRIOR NOTICE.

For information about your product, or for information on how to exchange or repair your product, telephone or write to the following:

#### FUNAI CORPORATION

Customer Service

100 North Street; Teterboro, NJ 07608

Telephone (800)242-7158

PLEASE DO NOT SHIP YOUR UNIT TO THE TETERBORO ADDRESS.



## Free Manuals Download Website

<http://myh66.com>

<http://usermanuals.us>

<http://www.somanuals.com>

<http://www.4manuals.cc>

<http://www.manual-lib.com>

<http://www.404manual.com>

<http://www.luxmanual.com>

<http://aubethermostatmanual.com>

Golf course search by state

<http://golfingnear.com>

Email search by domain

<http://emailbydomain.com>

Auto manuals search

<http://auto.somanuals.com>

TV manuals search

<http://tv.somanuals.com>