

# System Smoke Detectors



# System Smoke Detectors

## Contents

Foreword . . . . .	1	Section 4 – Proper Detector Applications, Placement and Spacing . . . . .	8
Introduction . . . . .	2	Where To Place Detectors . . . . .	8
Section 1 – Standards that Apply . . . . .	2	Where Not To Place Detectors . . . . .	9
NFPA Codes and Standards . . . . .	2	Special Application Detectors . . . . .	10
Building and Fire Codes . . . . .	2	Standards for Smoke Detectors . . . . .	10
Testing Laboratories . . . . .	2	Detector Spacing . . . . .	10
Industry Publications . . . . .	3	General Spacing Guidelines . . . . .	10
Manufacturer’s Publications . . . . .	3	Special Spacing Problems . . . . .	11
Section 2 – How Smoke Detectors Work . . . . .	3	Detectors in Air Handling and Air Conditioning Systems . . . . .	12
Ionization Smoke Detector Operation . . . . .	3	Detectors in Above-Ceiling Plenum Areas Including Plenums Utilized as Part of the HVAC System . . . . .	12
Photoelectric Smoke Detector Operation . . . . .	4	Section 5 – Testing, Maintenance and Service of Detectors . . . . .	13
Smoke Detector Design Consideration . . . . .	4	Typical Inspection, Test and Maintenance Practices . . . . .	13
Considerations in Selecting Detectors . . . . .	4	Section 6 – Troubleshooting Techniques . . . . .	14
Smoke Detectors Have Limitations . . . . .	5	What to Do About Unwanted Alarms . . . . .	14
Section 3 – Typical System Layout . . . . .	5	Reasons for Unwanted Alarms . . . . .	14
Electrical Supervision . . . . .	5	Maintain an Alarm Log . . . . .	14
Class B Circuits . . . . .	5	Effects of Location or Environment . . . . .	14
Class A Circuits . . . . .	6	Inspect Detector for Dirt and Review Maintenance . . . . .	14
Wireless Circuits . . . . .	6	Effects of other Systems on Alarm System Wiring . . . . .	15
General Zoning Guidelines . . . . .	6	Miscellaneous Causes of Unwanted Alarms . . . . .	15
Fire Safety Functions . . . . .	6	Responsibilities of Detector Owners and Installers . . . . .	15
Smoke Detector Installation . . . . .	6	Where to Get Help if the Source of Unwanted Alarms Can’t be Found . . . . .	16
Wiring Installation Guidelines . . . . .	6	Appendix 1 – Glossary of Terms . . . . .	17
Typical Wiring Techniques . . . . .	6	Appendix 2 – Alarm Log . . . . .	19
Wireless Systems . . . . .	8		
Installation Do’s and Don’ts . . . . .	8		
Wiring and System Checkout . . . . .	8		

## Foreword

Studies have shown that in the United States the use of early warning fire and smoke detection systems has resulted in a significant reduction overall in fire deaths. The sooner a fire is detected, the better the chances are for survival.

A potential problem with smoke detectors is unwanted alarms that often result in people being desensitized to the alarm system or in severe cases disconnecting the system. This is an industry-wide problem that in most cases is caused by improper application, installation and maintenance of smoke detectors. It is hoped that the information in this guide will be used by those involved with the application, installation and maintenance of fire alarm systems to minimize these problems.

## Introduction

The purpose of this guide is to provide information concerning the proper application of smoke detectors used in conjunction with fire alarm systems. It outlines basic principles that should be considered in the application of early warning fire and smoke detection devices. Operating characteristics of detectors and environmental factors, which may aid, delay or prevent their operation, are presented.

Fire protection engineers, mechanical and electrical engineers, fire service personnel, fire alarm designers and

installers should find the contents both educational and informative.

Though this information is based upon industry expertise and many years of experience, it is intended to be used only as a technical guide. The requirements of applicable codes and standards, as well as directives of the Authorities Having Jurisdiction (AHJ's) should be followed. In particular, the most current version of NFPA 72 for installation and testing of systems is a key element in the effectiveness of smoke detection systems.

### Section 1 Standards That Apply

#### NFPA Codes and Standards

NFPA publishes standards for the proper application, installation, and maintenance of automatic smoke detectors. The principal codes and standards that should be reviewed before specifying or installing automatic smoke detectors are listed below:

**National Fire Protection Association (NFPA)**  
**Batterymarch Park, Quincy, Massachusetts 02269-9101**  
 NFPA publishes codes and standards concerning all phases of fire protection. Among those which directly concern automatic smoke detectors are:

**NFPA 70: National Electrical Code**  
**NFPA 72: National Fire Alarm Code**  
 NFPA 72 covers minimum performance, location, mounting, testing, and maintenance requirements of automatic fire detectors.

**NFPA 90A: Standard for the Installation of Air Conditioning and Ventilating Systems**  
**NFPA 92A: Smoke Control Systems in Malls, Atria, and Large Areas**  
 NFPA 90A and 92A provide information for the use of smoke detectors in ducts of HVAC systems and smoke control systems.

**NFPA 101: Life Safety Code**  
 NFPA 101 specifies the requirements for smoke detection in both new and existing buildings depending on the type of occupancy.

#### Building and Fire Codes

There are three independent regional organizations which write model building and fire codes which become law when adopted by local and state governments. These codes specify smoke detector requirements based on building type and occupancy. The organizations are:

**Building Officials and Code Administrators (BOCA)**  
**4051 West Flossmoor Road, Country Club Hills, Illinois 60478-5795**  
 BOCA's National Building Code is generally used throughout the northeast and midwest regions of the United States.

**International Conference of Building Officials (ICBO)**  
**5360 Workman Mill Road, Whittier, California 90601-2298**

ICBO's Uniform Building Code is generally used throughout the West and Southwest regions of the United States.

**Southern Building Code Congress International (SBCCI)**  
**900 Montclair Road, Birmingham, Alabama 35213-1206**  
 SBCCI's Standard Building Code is generally used in the South and Southeast regions of the United States.

**International Code Council, Inc. (International Building Code/International Fire Code)**  
**5360 Workman Mill Road, Whittier, California 90601-2298**

The organizations listed above have formed an umbrella organization known as the International Code Council (ICC), for the purpose of combining the codes produced by the above three organizations into a single set of model building and fire codes. ICC's International Building Code and International Fire Code were first published in 2000 and have been adopted by some states.

#### Testing Laboratories

Testing laboratories test smoke detectors, control panels and other components of fire alarm systems to verify conformance with NFPA requirements and their own standards. Equipment that passes their tests are identified by a label and/or listing.

**Underwriters Laboratories, Inc. (UL)**  
**333 Pfingsten Road, Northbrook, Illinois 60062**  
**1655 Scott Boulevard, Santa Clara, California 95050**  
**1285 Walt Whitman Road, Melville, New York 11747**  
**12 Laboratory Drive, P.O. Box 13995, Research Triangle Park, North Carolina**

UL publishes an annual directory listing fire protection equipment which bear the UL label. Its standards which apply to smoke detectors are:

**UL 217: Single and Multiple Station Smoke Detectors**  
**UL 268: Smoke Detectors for Fire Protection Signaling Systems**  
**UL 268A: Smoke Detectors for Duct Applications**  
**UL 864: Standard for Control Units for Fire Protective Signaling Systems**

**Factory Mutual Research (FM)**  
**1151 Boston-Providence Turnpike, P.O. Box 9102, Norwood, Massachusetts 02062**

FM publishes an annual report listing fire protection equipment which bears its label.

**Industry Publications**

- NEMA Guide for Proper Use of Smoke Detectors in Duct Applications
- NEMA Training Manual on Fire Alarm Systems
- NEMA Guide to Code Requirements for Fire Protective Signaling and Detection Systems
- NEMA Guide for proper Use of System Smoke Detectors

**Manufacturer's Publications**

The manufacturer of the smoke detectors being used should be contacted for any published information on their products.

**Section 2**

**How Smoke Detectors Work**

There are two basic types of smoke detectors in use today; ionization and photoelectric.

The sensing chambers of these detectors use different principles of operation to sense the visible or invisible particles of combustion given off in developing fires.

**Ionization Smoke Detector Operation**

A typical ionization chamber consists of two electrically charged plates and a radioactive source (typically Americium 241) for ionizing the air between the plates. (See Figure 1.) The radioactive source emits particles that collide with the air molecules and dislodge their electrons. As molecules lose electrons, they become positively charged ions. As other molecules gain electrons, they become negatively charged ions. Equal numbers of positive and negative ions are created. The positively charged ions are attracted to the negatively charged electrical plate, while the negatively charged ions are attracted to the positively charged plate. (See Figure 2.) This creates a small ionization current that can be measured by electronic circuitry connected to the plates ("normal" condition in the detector).

Electronic circuitry monitors both chambers and compares their outputs. If the humidity or the atmospheric pressure changes, both chambers' outputs are affected equally and cancel each other. When combustion particles enter the sensing chamber, its current decreases while the current of the reference chamber remains unchanged. The resulting current imbalance is detected by the electronic circuitry. (See Figure 5.) There are a number of conditions that can affect dual-chamber ionization sensors; dust, excessive humidity (condensation), significant air currents, and tiny insects can be misread as particles of combustion by the electronic circuitry monitoring the sensors.

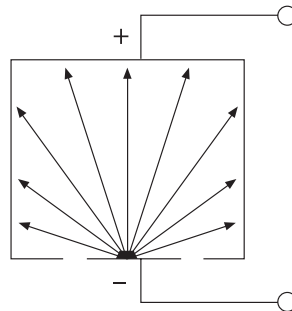

Figure 1: Particle Radiation Pattern

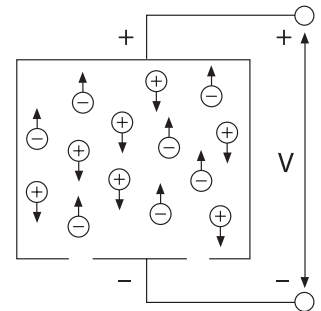

Figure 2: Ion Distribution

Particles of combustion are much larger than the ionized air molecules. As particles of combustion enter an ionization chamber, ionized air molecules collide and combine with them. (See Figure 3.) Some particles become positively charged and some become negatively charged. As these relatively large particles continue to combine with many other ions, they become recombination centers, and the total number of ionized particles in the chamber is reduced. This reduction in the ionized particles results in a decrease in the chamber current that is sensed by electronic circuitry monitoring the chamber. When the current is reduced by a predetermined amount, a threshold is crossed and "alarm" condition is established.

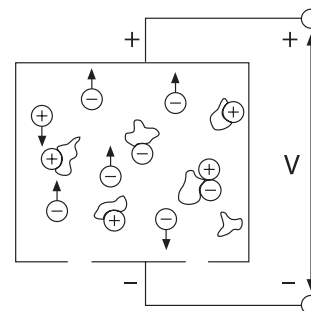

Figure 3: Ion and Particles of Combustion Distribution

Changes in humidity and atmospheric pressure affect the chamber current and create an effect similar to the effect of particles of combustion entering the sensing chamber. To compensate for the possible effects of humidity and pressure changes, the dual ionization chamber was developed and has become commonplace in the smoke detector market.

A dual-chamber detector utilizes two ionization chambers; one is a sensing chamber that is open to the outside air. (See Figure 4). The sensing chamber is affected by particulate matter, humidity, and atmospheric pressure. The other is a reference chamber that is partially closed to outside air and affected only by humidity and atmospheric pressure, because its tiny openings block the entry of larger particulate matter including particles of combustion.

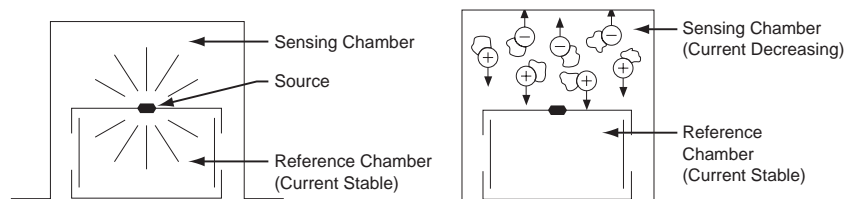

Figure 4: Dual Chamber

Figure 5: Dual Chamber with Particles of Combustion

### Photoelectric Smoke Detector Operation

Smoke produced by a fire affects the intensity of a light beam passing through air. The smoke can block or obscure the beam. It can also cause the light to scatter due to reflection off the smoke particles. Photoelectric smoke detectors are designed to sense smoke by utilizing these effects of smoke on light.

#### Photoelectric Light Scattering Smoke Detector

Most photoelectric smoke detectors are of the spot type and operate on the light scattering principle. A light-emitting diode (LED) is beamed into an area not normally “seen” by a photosensitive element, generally a photodiode. (See Figure 6.) When smoke particles enter the light path, light strikes the particles (Figure 7) and is reflected onto the photosensitive device causing the detector to respond.

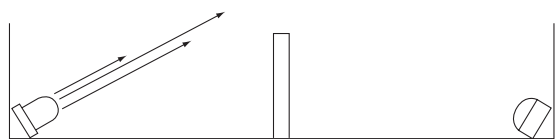

Figure 6: Light Scattering Detector

#### Photoelectric Light Obscuration Smoke Detector

Another type of photoelectric detector, the light obscuration detector, employs a light source and a photosensitive receiving device, such as a photodiode (see Figure 8). When smoke particles partially block the light beam (Figure 9), the reduction in light reaching the photosensitive device alters its output. The change in output is sensed by the detector’s circuitry, and when the threshold is crossed, an alarm is initiated. Obscuration type detectors are usually of the projected beam type where the light source spans the area to be protected.

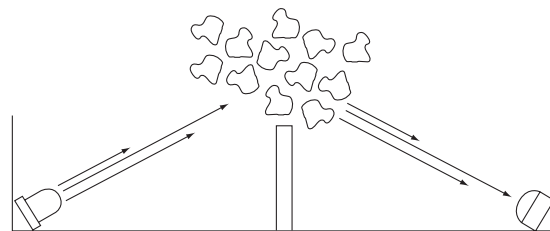

Figure 7: Light Scattering Detector with Smoke

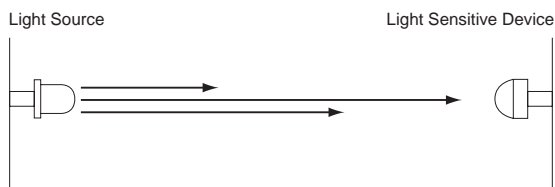

Figure 8: Light Obscuration Detector

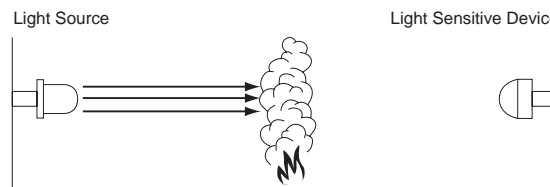

Figure 9: Light Obscuration Detector with Smoke

### Smoke Detector Design Considerations

Smoke detectors are based on simple concepts, but certain design considerations need to be observed. They should produce an alarm signal when smoke is detected, but should minimize the impact of an unwanted signal which can arise from a variety of causes. In an ionization detector, dust and dirt can accumulate on the radioactive source and cause it to become more sensitive. In a photoelectric detector, light from the light source may be reflected off the walls of the sensing chamber and be seen by the photosensitive device when no smoke is present. The entrance of insects, dirt, drywall dust, and other forms of contamination into the sensing chamber can also reflect light from the light source onto the photosensitive device.

Electrical transients and some kinds of radiated energy can affect the circuitry of both ionization and photoelectric smoke detectors and be interpreted by the electronic circuitry to be smoke, resulting in nuisance alarms.

The allowable sensitivity ranges for both types of detectors are established by Underwriters Laboratories, Inc. and all are verified by their performance in fire tests. Regardless of their principle of operation all smoke detectors are required to respond to the same test fires.

### Considerations in Selecting Detectors

The characteristics of an ionization detector make it more suitable for detection of fast flaming fires that are characterized by combustion particles in the 0.01 to 0.4 micron size range. Photoelectric smoke detectors are better suited to detect slow smoldering fires that are characterized by particulates in the 0.4 to 10.0 micron size range. Each type of detector can detect both types of fires, but their respective response times will vary, depending on the type of fire.

Because the protected buildings normally contain a variety of combustibles, it is often very difficult to predict what size particulate matter will be produced by a developing fire. The fact that different ignition sources can have different effects on a given combustible further complicates the selection. A lighted cigarette, for example, will usually produce a slow smoldering fire if it is dropped on a sofa or bed. However, if the cigarette happens to fall upon a newspaper on top of a sofa or bed, the resulting fire may be characterized more by flames than by smoldering smoke.

The innumerable combustion profiles possible with various fire loads and possible ignition sources make it difficult to select the type of detector best suited for a particular application.

For more information, see NFPA 72-1999, paragraphs A-2-3.6.1.2, A-2-3.6.1.1, A-2-3.6.1.2(a), and A-2-3.6.1.2(b).

NFPA 72 requirements also dictate that alarm notification appliances (including smoke detectors with built-in sounders) produce the 3-pulse temporal pattern fire alarm evacuation signal described in ANSI S3.41. (Audible Emergency Evacuation Signals)

**Situations Where Other Types of Detectors May Be Used**

In certain circumstances where standard smoke detectors are unsuitable, special-purpose detectors, such as flame detectors, heat detectors, and other detection devices may be used.

The application of these special types of detectors should be based on an engineering survey and used in accordance with the manufacturer’s installation instructions provided.

**Smoke Detectors Have Limitations**

Smoke detectors offer the earliest possible warning of fire. They have saved thousands of lives in the past and will

save more in the future. Nevertheless, smoke detectors do have limitations. They may not provide early warning of a fire developing on another level of a building. A first floor detector, for example, may not detect a second floor fire. For this reason, detectors should be located on every level of a building. In addition, detectors may not sense a fire developing on the other side of a closed door. In areas where doors are usually closed, detectors should be located on both sides of the door.

As already indicated, detectors have sensing limitations. Ionization detectors are better at detecting fast, flaming fires than slow, smoldering fires. Photoelectric smoke detectors sense smoldering fires better than flaming fires. Because fires develop in different ways and are often unpredictable in their growth, neither type of detector is always best. A given detector may not always provide significant advance warning of fires when fire protection practices are inadequate, nor when caused by violent explosions, escaping gas, improper storage of flammable liquids such as cleaning solvents, etc.

**Section 3  
Typical System  
Layout**

**Wiring Supervision**

The initiating circuits that connect smoke detectors to a control panel should be supervised so that a fault (trouble) condition that could interfere with the proper operation of the circuit will be detected and annunciated.

Smoke detectors are generally categorized as either 2-wire or 4-wire detectors. Two-wire detectors derive their power directly from the same fire alarm control panel alarm initiating device circuit over which they report an alarm. Because of their dependency on the initiating circuit, 2-wire detectors must be tested and listed for compatibility with the control panel to be used, to ensure proper operation.

Four-wire detectors are powered from a separate pair of wires, and, like the 2-wire detector, apply an electrical short across the associated alarm initiating device circuit to transmit an alarm (Figure 10). Because they do not derive power from the alarm initiating device circuit, electrical compatibility is predicated upon the operating parameters of the power supply to which the detectors are connected and not the initiating circuit. Supervision of the power to 4-wire detectors is mandated through the use of an end-of-line power supervision relay. When power is on, the relay contacts of the end-of-line relay are closed and connected in series with the end-of-line resistor beyond the last initiating device. Loss of power at any point in the power supply circuit will cause the relay to de-energize and a trouble condition to occur on the initiating circuit.

NOTE\*: Refer to the fire alarm control panel manufacturer’s operating manual to determine the ability of a specific initiating circuit to react in a “Class B” or “Class A” fashion.

**Class B Circuits**

Class B circuits differentiate between short circuits across the loop (alarm) and opens on the loop (trouble). Supervision of this circuit is accomplished by passing a low current through the installation wiring and an end-of-line resistor. Increases or decreases in this supervisory current are monitored by the fire alarm control panel and will cause alarm or trouble conditions, respectively, to be indicated. A single open in a Class B circuit disables all devices electrically beyond the open.

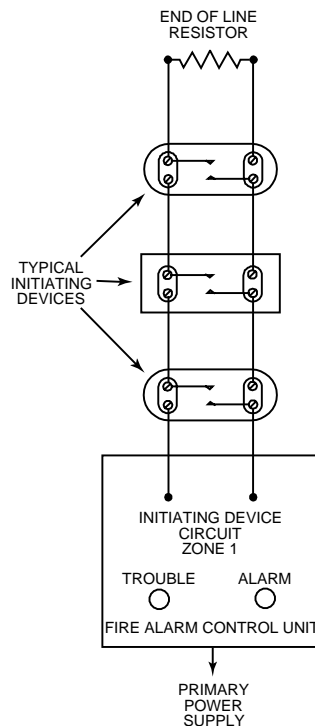

Figure 10: Two-Wire Detector Circuit

\*NFPA 72 now classifies initiating device circuits by “Style” and “Class”. Style B is an example of a Class B circuit; Style D is an example of a Class A circuit.



### Class A Circuits

Class A circuits also differentiate between short circuits across the loop and opens on the loop. Supervision is accomplished by monitoring the level of current passing through the installation wiring and the end-of-line resistor, which in a Class A circuit is an integral part of the fire alarm control panel. Class A wiring must return to and be terminated in the control panel. This technique requires a minimum of four conductors to be terminated at the panel, and further requires that the fire alarm control panel is designed to monitor Class A circuits. The additional circuitry necessary for Class A supervision enables the control panel to “condition” the initiating circuit to monitor the initiating circuit from both ends when in a trouble mode due to an open fault on the loop. This “conditioning” ensures that all devices are capable of responding and reporting an alarm despite a single open or non-simultaneous single ground fault on a circuit conductor.

The compatibility considerations of smoke detectors that were detailed in Class B circuits apply with Class A as well (Figure 11).

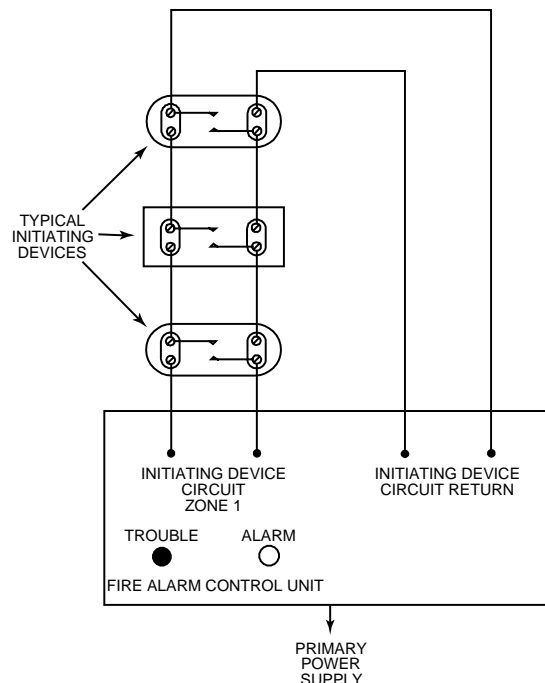

Figure 11: 2-Wire Detectors – Style D (Class A) Circuit

### Wireless Circuits

Wireless detectors and their internal transmitters derive their operating power from their internal battery or batteries and are listed by Underwriters Laboratories, Inc. in accordance with requirements of NFPA 72. Supervision of the internal battery power source is incorporated within the smoke detector circuitry. If the battery power source depletes to the threshold specified by Underwriters Laboratories, the smoke detector will sound a local alert and initiate a trouble signal once each hour for a minimum of seven days or until the battery or batteries are replaced.

The wireless initiating devices are supervised for tamper and/or removal by initiating a distinct trouble signal. Each wireless device also initiates a test transmission every hour to verify the reliability of the communication circuit. Any device failing to communicate is identified on the control panel no less than every four hours.

### General Zoning Guidelines

The faster the source of an alarm can be pinpointed, the faster action can be taken. Although formal rules for zoning are not given in fire protection codes, except for wireless devices where each smoke detector must be individually identified, it is always sensible to zone any system that contains more than a small number of detectors. Experienced detector installers and system designers recommend the following:

- Establish at least one zone on every protected floor.
- Zone natural subdivisions of a large building, such as separate wings on a single floor.
- Minimize the number of detectors in each zone. Fewer detectors on a zone will speed up locating the fire and simplify troubleshooting.
- Install duct detectors in different zones than open-area detectors for troubleshooting and locating purposes.

### Fire Safety Functions

Often smoke detectors are utilized to control ancillary equipment. Most detectors used in releasing service have auxiliary relay contacts which are directly connected to the system or device to be controlled. Care should be taken to ensure that detectors utilized in such a manner are approved for releasing service. A few of the typical applications are as follows:

- To control the flow of smoke in air handling and air conditioning systems.
- To release doors to contain smoke in a fire situation.
- To release locks to allow exit in a fire situation.
- To capture and recall elevators in a fire situation.
- To activate a suppression system.

Spacing and placement requirements for detectors used in releasing service may be different from detectors used in conventional open area applications. It is recommended that 4-wire detectors be used in these situations because depending on the control panel and detectors used, more than one detector relay on a circuit may not receive enough power from the 2-wire circuit to operate during alarm.

### Smoke Detector Installation

#### Wiring Installation Guidelines

All fire alarm system installation wiring should be installed in compliance with Article 760 of NFPA 70, the National Electrical Code (NEC), the manufacturer’s instructions and the requirements of the authority having jurisdiction.

#### Typical Wiring Techniques

The primary rule of installation wiring is:

#### “Follow the Manufacturer’s Instructions”

This rule cannot be overemphasized. The requirement for electrical supervision of the installation wires and their connections to initiating devices makes fire alarm system installation wiring very different than general wiring.

A manufacturer's installation wiring drawing routes wires and shows connections in a certain manner to accommodate supervision requirements. Any variance from the manufacturer's drawings might cause a portion of a circuit to be unsupervised and, if an open or short circuit fault occurred, it could prevent the circuit from being able to perform its intended function without giving the required trouble indication.

The rules of supervision are not very complex. However, unless an installer is experienced in fire alarm system installations, he or she would not likely be familiar with them.

Smoke detector manufacturer's installation drawings will show how their detectors are to be connected into a system. However, a manufacturer's drawings may not show how devices located on the same floor, but served by a different riser (vertical wiring run), should be connected. The diagrams on the following page should be considered as typical initiating device circuits utilizing smoke detectors. They are offered to illustrate proper and improper installation wiring and termination techniques. Since there are always exceptions to typical installation drawings, experienced installers use the primary rule of installation wiring: Follow the manufacturer's instructions, and meet the local codes.

Figure 12 illustrates improper wiring of smoke detector "A". This wiring method is referred to as "T-tapping." This common installation error is often made in riser wiring as well as single floor wiring. The smoke detector may operate properly under alarm conditions. If it becomes disconnected from the installation wiring loop beyond the "T-tap", however, the detector would not function, and no "trouble" condition would occur.

NOTE: "T-tapping" may be permitted with some "intelligent" fire alarm systems. Refer to manufacturer's recommendations.

Figure 13 illustrates the correct installation wiring method for smoke detectors. None of the connections can be broken without opening the circuit, causing loss of supervision, and the fire alarm control panel to indicate trouble.

Smoke detectors should be connected to supervised installation wiring in a manner that ensures electrical supervision of the device. Removal of a detector from its associated initiating circuit should cause the loop to open, resulting in a trouble condition. The required termination at the smoke detector may involve either screw terminals or wire pigtails. Regardless of the method utilized, removal of the smoke detector or a single installation wire must open the initiating circuit and result in a trouble signal at the control panel.

Screw termination of either side of the initiating circuit may require only one or two screws. Figure 14 is an example of proper termination when one screw terminal is used. Note that the installation conductor has been cut before termination. This assures full supervision of the smoke detector.

Figure 15 details common connection errors. In both examples, removal of the smoke detector wire does not open the initiating circuit. The fire alarm control panel will not recognize a trouble condition, and the detector that has been deliberately or inadvertently disconnected will be disabled.

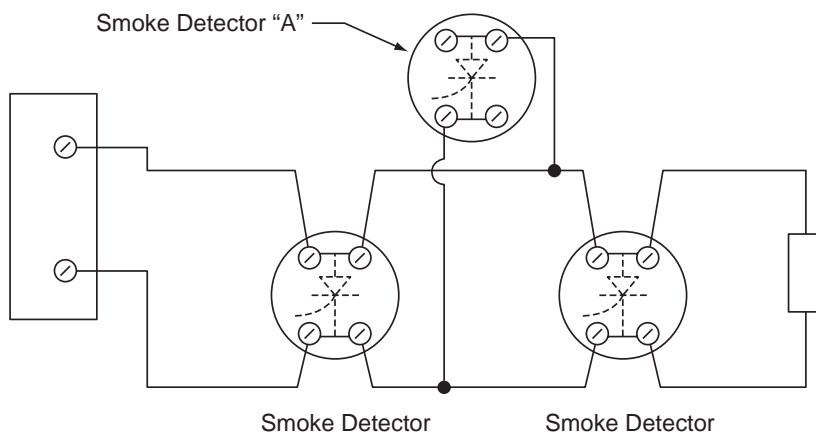

Figure 12: Incorrect Wiring Method

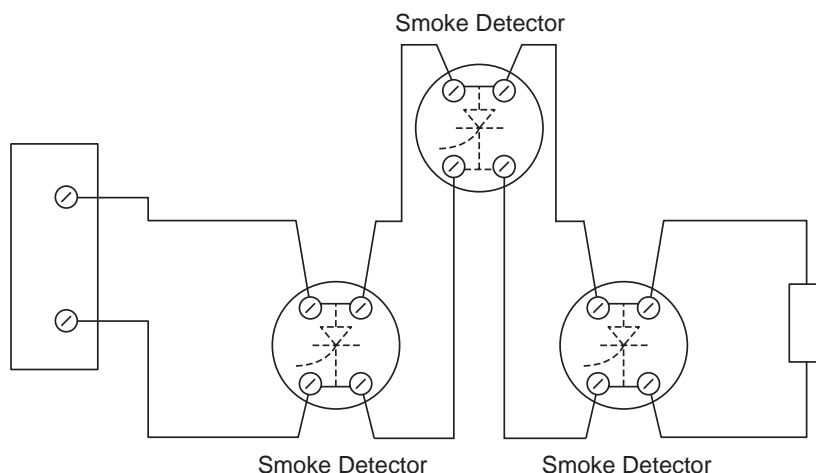

Figure 13: Correct Wiring Method

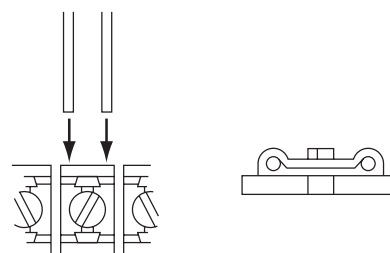

Figure 14: Proper Termination

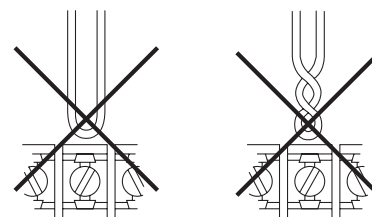

Figure 15: Improper Termination



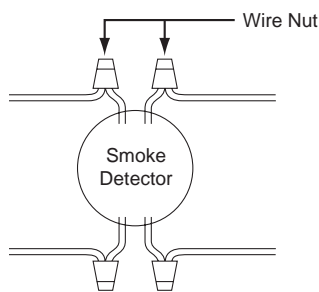

Figure 16: Pigtail Connections – Correct Wiring Method

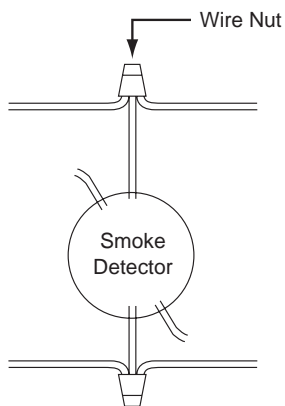

Figure 17: Pigtail Connections – Incorrect Wiring Method

Figure 16 is an example of properly connected smoke detectors provided with pigtails. This method of termination supervises all wiring to the point at which it connects to the detector.

Figure 17 shows an incorrect pigtail connection. This is a form of “T-tapping” discussed earlier. Note that the conductor between the wire nut (or splice) and the detector is unsupervised, and could be cut or disconnected without resulting in a trouble signal.

### Wireless Systems

Wireless smoke detectors do not require any field wiring as the power for the initiating devices is contained and incorporated within the device. Removal of a wireless smoke detector initiates a distinct tamper or trouble signal. Follow the instructions in the manufacturer’s installation manual for wireless systems.

### Installation Do’s and Don’ts

#### Do:

- Verify that 2-wire smoke detectors to be used have been tested and UL listed for compatibility with the equipment to which they are connected. If necessary, contact the manufacturer for this information.
- Locate any end-of-line devices electrically at the end of the circuit, beyond all initiating devices (not at the control unit, except in a Class A installation).
- Use caution when utilizing 2-wire detectors with integral relays, because they

may require more power than the initiating device circuit can supply. This could result in the inability of the relay to control auxiliary equipment to which it is connected.

- When using wireless detectors, follow the manufacturer’s installation instructions to assure proper radio communication between the smoke detector and the control panel.
- Observe polarity when required.
- Protect detectors against contamination during construction or renovation.
- Carefully follow the manufacturer’s installation instructions.

#### Don’t:

- “T-tap” smoke detectors or circuit conductors, except when specifically permitted by the manufacturer as part of an intelligent/addressable system.
- Loop uncut installation conductors around screw terminations.
- Exceed the maximum resistance permitted for the initiating device system.
- Exceed the number of 2-wire detectors allowed on a 2-wire initiating circuit (specified by UL).

### Wiring and System Checkout

As required for all installation wiring of fire alarm systems, check the detector loop wiring for grounds, short circuits, and open faults before the system is placed into operation. Each detector should be tested in accordance with the manufacturer’s instructions.

When using wireless detectors, verify the radio signal transmission strength in accordance with the installation manual.

## Section 4 Proper Detector Applications, Placement and Spacing\*

checkout consists of testing each detector at its installed location and following the panel manufacturer’s instructions for system checkout. Also, refer to NFPA 72 for additional information.

### Where to Place Detectors

Detector placement is critical to early warning functions. To provide effective early warning of a developing fire situation, smoke detectors should be installed in all areas of the protected premises. Total coverage as defined by NFPA 72 should include all rooms, halls, storage areas, basements, attics, lofts, and spaces above suspended ceilings including plenum areas utilized as part of the HVAC system. In addition, this should include all closets, elevator shafts, enclosed stairways, dumbwaiter shafts, chutes and other subdivisions and accessible spaces.

Fire detection systems installed to meet local codes or ordinances may not be adequate for early warning of fire.

\*The guidelines in this section of the guide are adapted from Standards published by the National Fire Protection Association, Quincy, Massachusetts, USA. These standards include NFPA 72, National Fire Alarm Code; NFPA 70, “National Electrical Code”, Article 760; and NFPA 90A, “Installation of Air Conditioning and Ventilating Systems”.

After all detectors have been installed, test the complete system to ensure that no wiring faults exist, and that all parts of the system operate as intended. A complete system

Some codes or ordinances have minimum objectives such as capturing elevators or preventing circulation of smoke through the HVAC systems instead of early detection of fire.

A user should weigh the costs against the benefits of installing a complete fire detection system when any detection system is being installed. The location, quantity and zoning of detectors should be determined by what objectives are desired rather than the minimum requirements of any local codes or ordinances.

“Total coverage”, as defined in NFPA 72, is the definition of a complete fire detection system. In some of the specified areas of coverage, such as attics, closets, under open loading docks or platforms, a heat detector may be more appropriate than a smoke detector. Careful consideration should be given to the detector manufacturer’s instructions and the following recommendations in this guide.

In general, when only one detector is required in a room or space, the detector should be placed as close to the center of the ceiling as possible. Central location of the detector is best for sensing fires in any part of the room. If a center location is not possible, it may be placed no closer than 4 inches from the wall, or if listed for wall mounting, it may

be mounted on the wall. Wall-mounted detectors should be located not less than 4 inches nor more than 12 inches from the ceiling to the top of the detector, and at least 4 inches (10 cm) from any corner wall junction. (See Figure 18.)

When air supply and/or air return ducts are present in a room or space, the detector(s) should not be placed in the path of the air flow supply or return duct (NFPA 72, 1999 Edition).

Smoke tests are helpful in determining proper placement. Special attention should be given to smoke travel directions and velocity, since either can affect detector performance.

Placement of detectors near air conditioning or incoming air vents can also cause excessive accumulation of dust and dirt on the detectors. This dirt can cause detectors to malfunction and cause unwanted alarms. Detectors should not be located closer than 3 feet from an air supply diffuser or an air return vent.

Spot type detectors, in properly engineered systems, may also be placed in return air ducts, or in approved duct detector housings designed for this application. Although duct detectors are not a substitute for open area detectors, they can provide an effective method of initiating building control functions to prevent smoke from being transported from the fire area to other parts of a building. (See Duct Smoke Detector Applications Guide.)

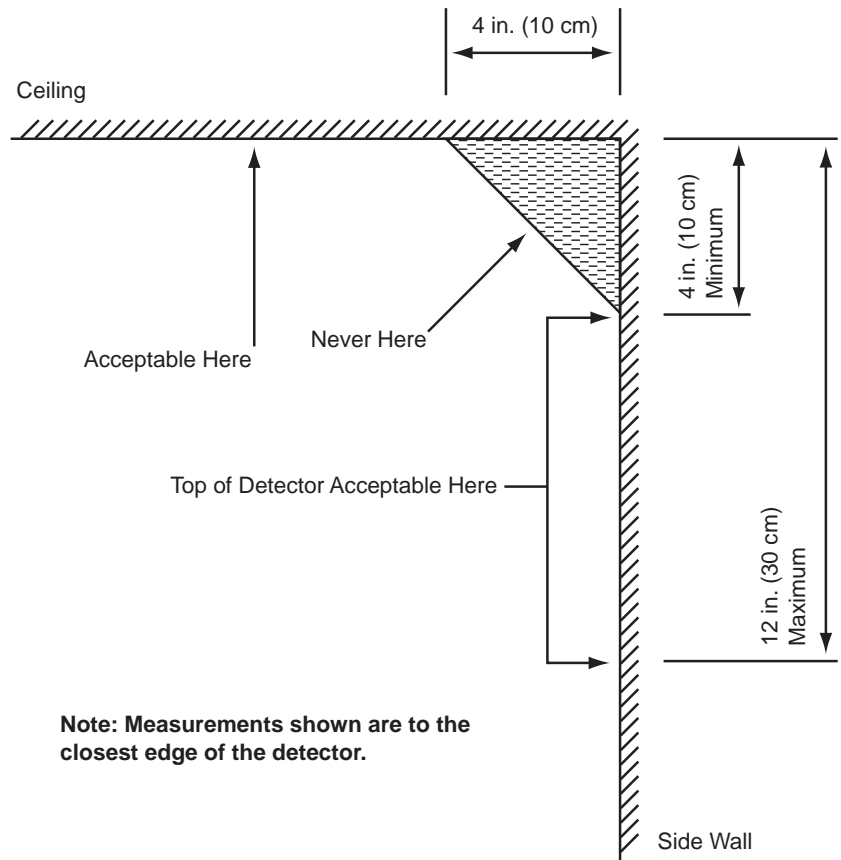

Figure 18: Wall Mounted Detector – Placement

### Where Not To Place Detectors

See Table A-2-3.6.1.2A in NFPA 72-1999.

One of the major causes of unwanted alarms is improper placement of detectors. The best way to avoid unwanted alarms is not to install detectors in environments that can cause them to malfunction, or to install detectors specially designed for those environments. Examples follow:

- **Excessively Dusty or Dirty Areas**  
In excessively dusty or dirty areas consider using the Filtrex™ smoke detector. This detector incorporates a microprocessor-controlled air intake fan and filter that allows the unit to be installed in areas where ordinary detectors cannot be used. Filtrex is an intelligent smoke detector that removes airborne particles before they reach the sensing chamber. It is ideal for textile mills, dusty manufacturing facilities, paper mills, and recycling centers. For more information see System Sensor's *Filtrex™ Applications Guide*.
- **Outdoors**  
Avoid using detectors outdoors, in open storage sheds, or other open structures affected by dust, air currents, or excessive humidity and temperature extremes.
- **Wet or Excessively Humid Areas**  
Avoid damp, wet or excessively humid areas, or next to bathrooms with showers.
- **Elevator Lobbies**  
Do not place over ashtrays or where people will smoke while waiting for the elevator.

- **Extreme Cold or Hot Environments**  
Avoid very cold or very hot environments, or unheated buildings or rooms where the temperature can fall below or exceed the operating temperature range of the detector. At temperatures above or below the operating range of the detector\*, its internal components may not function properly.  
\*Manufacturers' specifications should list acceptable temperatures in these ranges.
- **Areas with Combustion Particles**  
Avoid areas where particles of combustion are normally present, such as in kitchens or other areas with ovens and burners; in garages, where particles of combustion are present in vehicle exhausts. When a detector must be located in or adjacent to such an area, a heat detector may be appropriate.
- **Manufacturing Areas**  
Avoid manufacturing areas, battery rooms, or other areas where substantial quantities of vapors, gases, or fumes may be present. Strong vapors can make detectors overly sensitive or less sensitive than normal. In very large concentrations, gases heavier than air, such as carbon dioxide, may make detectors more sensitive, while gases lighter than air, such as helium, may make them less sensitive. Aerosol particles may collect on detector chamber surfaces and cause nuisance alarms.
- **Fluorescent Light Fixtures**  
Avoid placement near fluorescent light fixtures. Electrical noise generated by fluorescent light fixtures may cause unwanted alarms. Install detectors at least 1 foot (0.3 m) away from such light fixtures.

### Special Application Detectors

The guidelines in this document generally apply to standard open-area smoke detectors. System Sensor has a number of advanced technology detectors that are optimized for specific environments and should be considered.

Pinnacle™ Laser technology smoke detector is designed for use in areas that require extremely early warning of fire. It is designed to detect the earliest particles of combustion making it ideal for clean rooms, computer rooms or telecommunication centers — any area where any damage is too much. As Pinnacle is ultra-sensitive to smoke — as much as 100 times more sensitive than standard detectors — care and judgement of application is needed to prevent unwanted alarms. See System Sensor’s *Pinnacle™ Applications Guide*.

For environments classified as hazardous, System Sensor offers Intrinsically Safe Detectors designed to provide detection for high-risk areas such as oil production facilities, refineries and chemical plants. These units operate on low energy levels and are used with a safety barrier. See our Guide for Proper Use of Intrinsically Safe Fire Protection Devices.

### Standards for Smoke Detectors

Underwriters Laboratories (UL) has three standards for smoke detectors: one for duct detectors, UL 268A; one for single and multiple station smoke alarms, UL 217; and one for systems type detectors, UL 268. Detectors should only be used for the applications for which they are specifically listed.

The 2000 NFPA 101 Life Safety Code notes in Section 9.6.2.10.4 that single station smoke alarms shall sound an alarm only within an individual living unit, suite of rooms, or similar area and shall not actuate the building fire alarm system unless otherwise permitted by the authority having jurisdiction. Section 9.6.1.5 states, “All systems and components shall be approved for the purpose for which installed.”

In addition to possible code noncompliance, the following deficiencies would exist in a series of residential smoke detectors, connected in a system mode:

- Since the system is not supervised, vandals or others could disconnect a detector or the entire system, leaving a building without protection. The residents would be unaware of this serious life threatening condition.
- Residential smoke alarms do not latch in alarm. In other words, the smoke alarm self-resets. One smoke alarm in alarm will sound all the smoke alarms connected together. It would be difficult to identify or locate a specific smoke alarm that initially put the system into alarm after the alarm condition was cleared.

System detectors latch in alarm. They do not reset until power is momentarily disconnected. This makes it convenient to identify the location of a detector that caused the control panel to alarm. In addition, system detectors are specifically designed to connect to a panel. Two-wire detectors require a UL compatibility review to verify that the detector and panel operate together. A typical life safety fire protection system for an apartment complex would be

to use system detectors and manual fire alarm stations in the hallways and common areas of the complex and residential single station type smoke detectors and heat detectors in the individual apartments. The system detectors, manual stations and heat detectors would be connected to a control panel, sound a general alarm and automatically notify the proper authorities that a fire condition exists. The residential smoke detectors located in the apartments would be interconnected only within the individual living quarters of each apartment. These residential units would sound an alarm only in the apartment where a fire started.

### Detector Spacing

#### General Spacing Guidelines

Some fire protection codes specify detector spacing on a given center-to-center distance between detectors under ideal conditions. These distances are based on rooms with smooth ceilings with no physical obstructions between the contents being protected and the detectors. Moreover, they are also based on a maximum ceiling height, and on the assumption that the value and the combustible nature of the contents of the room to be protected do not warrant greater protection or closer spacing.

If we assume a typical center distance spacing guideline is 30 feet (90 meters), how do we determine whether a given room or space can be protected by a single detector? Figure 19 shows four detectors spaced horizontally and vertically 30 feet (9 meters) apart. Detectors B and D, however, are more than 30 feet apart. Clearly, in this example detector spacing can exceed the given 30 foot spacing and still comply with the code if any source of combustion is within 21.2 feet (6.4 meters) of the horizontal projection of a detector, and if no more than 900 square feet (82.8 square meters) are being protected by one detector.

To determine what coverage patterns are permissible within the 30 foot spacing, start by tracing a circle with a radius of 21.2 feet. Keeping in mind the fact that most rooms and areas to be protected are rectangular or square in shape, any square or rectangle that fits within the circumference of the circle may be protected by one detector. (See Figure 20.)

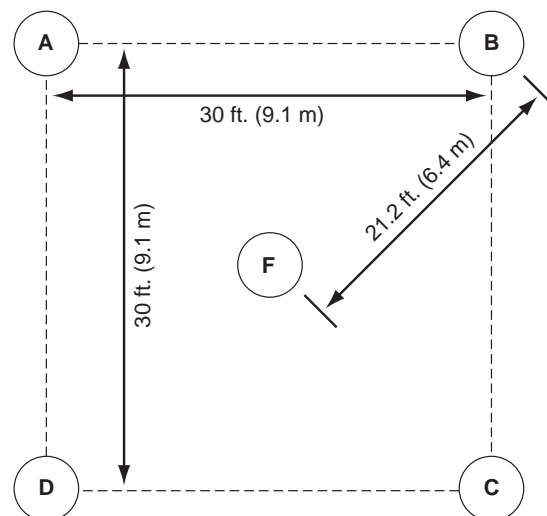

Figure 19: Typical Detector Spacing

In other words, if a diagonal through the center of the room is no greater than the diameter of the circle, or 42.4 feet (12.8 meters), one detector can be used under ideal conditions. Figure 21 shows how a length of hallway can be protected by only two detectors under ideal conditions.

**Special Spacing Problems**

The ideal conditions upon which code guidelines are based do not exist in the majority of buildings. Detector installers usually have to deal with a variety of problems, such as uneven ceilings or ceilings crossed by beams and joists; storage racks and partitions that obstruct the path of smoke toward detectors; air stratification due to uninsulated roofs, peaked or sloped ceilings, or localized heating or cooling from heating, ventilating, and air conditioning systems; and extensive variability in the value and combustion characteristics of building contents. The following are suggested techniques for dealing with some of the special detector spacing problems:

- Solid joist and beam construction. Per NFPA 72-1996, solid joists are to be considered equivalent to beams for smoke detector spacing guidelines. For ceiling heights of 12 ft. (3.66 m) or lower and beam depths of 1 ft. (0.3 m) or less, smooth ceiling spacing running in the direction parallel to the run of the beams is to be used, and 1/2 the smooth ceiling spacing is to be used in the direction perpendicular to the run of the beams. Spot-type detectors may be located either on the ceiling or on the bottom of the beams. For beam depths exceeding 1 ft. (0.3 m) or for ceiling heights exceeding 12 ft. (3.66 m), detectors are to be located on the ceiling in every beam pocket. If the beamed ceiling is also sloped, use the spacing determined for flat beamed ceilings. Use the average height over the slope as the ceiling height in such cases. Note that, by definition in NFPA 72, ceilings are to be considered smooth unless the beams or joists are more than 4 in. (0.1 m) in depth.
- High storage racks. Multi-level storage racks present special problems for early fire detection. Developing fires, especially smoldering fires, on the lower levels of the racks may not be sensed rapidly by ceiling mounted detectors. Upward convection of smoke can be slowed or blocked by goods stored on the upper levels of the racks. Multi-level fire detection is required. Detectors should be installed on the ceiling above each aisle and on intermediate levels of the racks adjacent to alternate pallet sections, shown in NFPA 72-1999, A-2-3.6.5. A consultant's judgement may be required for specific installations.
- Partitions. Partitions and many types of large, tall equipment standing on the floor can block the flow of smoke toward detectors. Any partition or similar obstruction that is less than 18 inches (45 cm) from the ceiling should be treated as a side wall dividing the area protected.
- Air Stratification. Air stratification in a room may keep air containing smoke from reaching ceiling-mounted detectors. Three conditions are known to accentuate air stratification: when a layer of hot air exists under a poorly insulated roof heated by the sun, cooler air will stratify the hot air layer at the ceiling; when a layer of cold air exists under a poorly insulated roof cooled from the outside by cold air, the heated air is cooled as it reaches the cold air layer; or when a heating, venti-

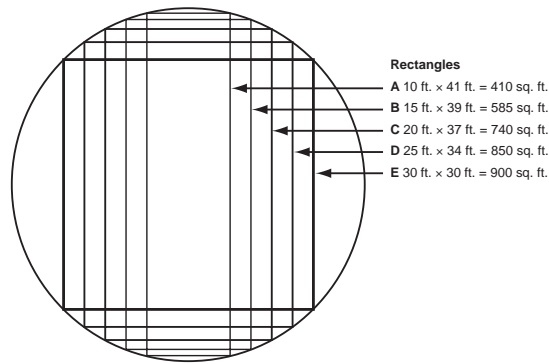

Figure 20: Detector Coverage Patterns

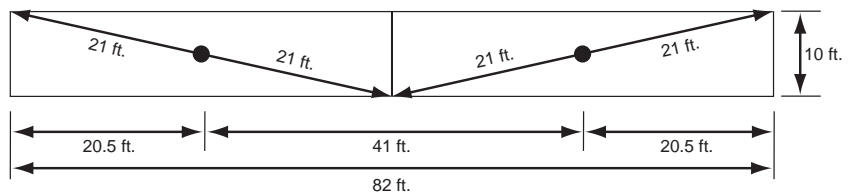

Figure 21: Detector Placement in Hallways

lating, or air conditioning (HVAC) system creates artificial hot or cold air layers in a room, the layers may affect the flow of smoke to the detectors.

- Uninsulated Roofs. Uninsulated roofs present special placement problems. Air movement toward ceiling detectors is not impeded when the outside temperature is cool, but stratification can occur when outside temperature is warm or hot, or when the roof is heated by the sun on bright, sunny days. Although true thermal barriers are not present in many installations, smoke tests should be run in factories or warehouses with metal roofs on warm sunny days to determine whether such a thermal barrier exists.
- Peaked or Sloped Ceilings. Peaked or sloped ceilings can foster air stratification. Codes may specify spacing detectors by using horizontal spacing from the peak of the roof or ceiling. For instance, if the specified distance from the peak is 3 feet (1 m), the distance is measured on the base of the right triangle formed by a vertical line dropped from the peak of the roof, with the roof incline as the hypotenuse. Additional detectors are installed on the selected spacing, using the horizontal distance, not the distance along the incline of the ceiling. (See Figure 22.)

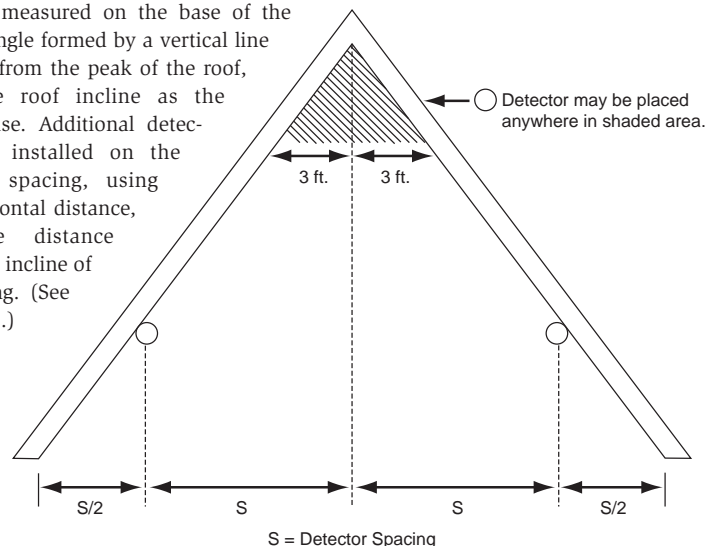

Figure 22: Detector Spacing Layout - Sloped Ceilings (peaked type)

- Alternate Detector Mounting. Mounting alternate detectors up to 3 feet (1 m) below the ceiling can increase detection of small or smoldering fires when the possibility of air stratification exists. Figure 23 illustrates such an installation. Specific designs for such an alternate detection should be based upon an engineering survey.
- Heating, Ventilating and Air Conditioning (HVAC) effects on air flow and air stratification should be determined and considered when planning detector placement. In rooms where forced-air ventilation is present, detectors should not be located where air from supply diffusers could dilute smoke before it reaches the detector. This may require additional detectors, because placing detectors only near return air openings may leave the balance of the area with inadequate protection, especially when the Heating, Ventilating and Air Conditioning (HVAC) system is not operating.
- Detectors placed in an above-ceiling air handling space should not be used as a substitute for open area protection, because smoke may not be drawn into the air handling space when the ventilating system is shut down. The detector will be less responsive to a fire condition in the room below than a detector located on the ceiling of the room below due to dilution and filtering of the air in the air handling space before the smoke reaches a detector. (See the discussion of detector placement in Section 4: Where To Place Detectors).
- Burn characteristics and the value of assets being protected influence the spacing of detectors and the amount of protection provided in a specific room or area. Refer to NFPA 72-1999, Section 2-3.6 for more detailed information on spacing of detectors under special applications. Likewise, if the contents are especially valuable, for example, sophisticated and expensive machinery or irreplaceable records, detectors should be placed closer together.

### Detectors in Air Handling and Air Conditioning Systems

See NEMA Guide for Proper Use of Smoke Detectors in Duct Applications and NFPA 72, National Fire Alarm Code for more specific information.

### Detectors in Above-Ceiling Plenum Areas Including Plenums Utilized as Part of the HVAC System

Detectors should be placed in plenum areas (above ceiling air handling space) in addition to the open area detectors installed in the open areas below and duct detectors installed in the ducts. Plenum detectors are required to be listed or tested and approved for the air velocities within the environment in which they are to be installed.

Detectors placed in plenums MAY NOT be used as a substitute for open area protection, because smoke may not be drawn into the plenum when the ventilating system is shut down. When the system is operating, the detector may be less responsive to a fire condition in the room below than will a detector located on the ceiling of the room below. This may be due to blockage, dilution, and filtering of the air prior to its arrival at the detector location in the plenum area.

Since the air circulating through the plenums is usually at higher velocities than would be prevalent in the room below, detector spacing should be reduced.

Also, the dilution of the smoke in plenum spaces is an important consideration when utilizing smoke detectors rated for higher velocities. Therefore, plenum detectors should be utilized to detect fire in the plenum but should never be utilized as a substitute for duct detectors and open area detectors.

Maintenance requirements of detectors exposed to unusual velocities (above 300 fpm) are generally increased due to the excessive dirt buildup and contamination present in these environments.

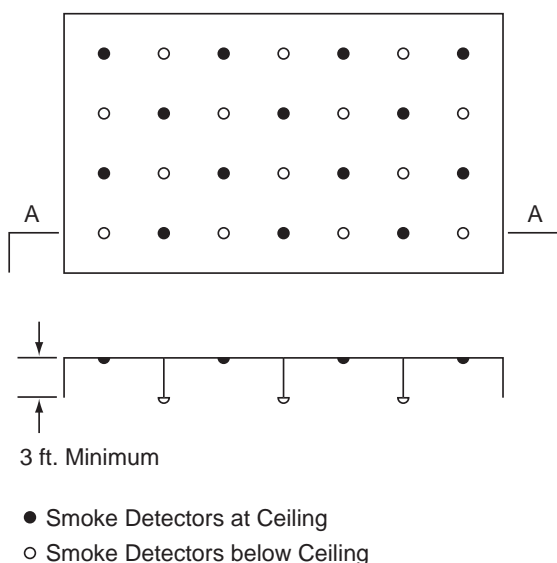

Figure 23: High Ceiling Area



## Section 5 Testing, Maintenance and Service of Detectors

Smoke detectors are designed to be as maintenance free as possible. However, dust, dirt, and other foreign matter can accumulate inside a detector's sensing elements and change its sensitivity. They can

become either more sensitive, which may cause unwanted alarms, or less sensitive, which could reduce the amount of warning time given in case of a fire. Both are undesirable. Therefore, detectors should be tested periodically and maintained at regular intervals. Follow closely the manufacturer's specific recommended practices for maintenance and testing. Also refer to Appendix B of NFPA 90A and NFPA 72, Chapter 7.

### Caution

Smoke detectors are sophisticated electronic devices that need periodic testing and maintenance. To maintain the integrity of any fire alarm system, it is important to have a qualified person periodically test the system.

## Typical Inspection, Test and Maintenance Practices

Detectors should be given a visual inspection at installation and at least twice a year thereafter. This ensures that each detector remains in good physical condition and that there are no changes that would affect detector performance, such as building modifications, occupancy hazards, and environmental effects.

Notify the proper authorities that the smoke detector is undergoing maintenance, and therefore the system will temporarily be out of service. NOTE: Disable the zone or system undergoing maintenance to prevent unwanted alarms and possible dispatch of the fire department.

Use a high power vacuum cleaner and remove dust from the detector by placing the nozzle as close as possible to the openings in the outside housing. A nozzle with a brush attachment will assist in dust removal. Some detector's sensing chambers can be removed for more thorough cleaning; refer to the manufacturer's recommended procedure for details.

Test each detector's sensitivity per the manufacturer's recommended procedure within one year after installation and every alternate year thereafter.

Test each detector functionally in place annually, as detailed in NFPA 72 1999 (Chapter 7).

If a detector's sensitivity is within specifications, nothing further needs to be done to the detector. If the detector's sensitivity is outside specifications, clean the detector and retest. If that does not place the sensitivity within the unit specified range then follow the manufacturer's recommended procedure.

Restore zone or system at the completion of testing.

Notify the proper authorities that testing has been completed and the system is again operational.

Refer to paragraph 7-4.1 of NFPA 72 for additional information.

To assure that each smoke detector is within its listed and marked sensitivity range it should be tested using either:

- A calibrated test method, or
- The manufacturer's calibrated sensitivity test instrument, or
- Listed control equipment arranged for the purpose, or
- Other calibrated sensitivity test method acceptable to the authority having jurisdiction.

Detectors found to have a sensitivity of 0.25 percent/ft. obscuration or more outside the listed and marked sensitivity range should be cleaned and recalibrated or replaced. Exception: Detectors listed as field adjustable may be either adjusted within the listed and marked sensitivity range, cleaned and recalibrated, or replaced.

Restore the zone or system at the completion of testing.

Notify all the persons contacted at the beginning of the test that testing has been completed and the system is again operational.

Some individuals rely on an aerosol chemical spray to test the sensitivity of a detector. This can give unsatisfactory results since an aerosol chemical spray does not accurately test detector sensitivity. NFPA 72-1999, Chapter 7, Section 7-3.2.1 notes that, "The detector sensitivity shall not be tested or measured using any device that administers an unmeasured concentration of smoke or other aerosol into the detector." The duration of spray, distance between the detector and the aerosol container, angle of discharge, and different environmental conditions can produce random results. In addition, many aerosols leave an oily residue. Over a period of time, this oily residue can attract dust or dirt, which can make a detector more sensitive and result in nuisance alarms.

Be sure to follow the manufacturer's recommendation on test gas, aerosol or smoke.



**Section 6**  
**Troubleshooting Techniques**

**What to Do About Unwanted Alarms**

No detection system is imper-  
vious to unwanted alarms.

Statistically, as the system size and the total number of detectors increases, the total number of nuisance alarms per year tends to increase. Historical experience in a given installation or data on similar sized buildings with similar utilization patterns can provide a basis for a rough indication of how many nuisance alarms are probable during a 12 month span; however, no two installations are identical.

In small- to moderate-sized detection systems protecting relatively combustion-free environments, like office buildings, more than one or two unwanted alarms per year would be unusual. In more adverse environments, such as laboratory or manufacturing facilities where combustion processes are present, more frequent alarms can be anticipated. In very adverse environments, one alarm per month might not be considered excessive.

After the first few months, which serve as a shakedown period, it should be possible to arrive at some reasonable expectation for probable unwanted alarms from the system. After that, any unexpected change in frequency or distribution indicates a problem that should be investigated. The best way to monitor alarm frequency and distribution is to maintain an alarm log.

**Reasons for Unwanted Alarms**

Unwanted alarms can result from a wide variety of causes, including:

- Improper locations are environments where they will not operate properly because of temperature extremes; excessive dust, dirt, or humidity, excessive air flow rates, or the normal presence of combustion particles in the air streams surrounding the detectors.
- Improper installation can occur when detectors and their wiring are not protected from interference from induced currents and noise in adjacent wiring systems, radio-frequency transmissions, and other types of electromagnetic effects.
- Inadequate maintenance can result in the accumulation of dust and dirt on the detector’s sensing chambers over a period of time.
- Seasonal effects such as the reactivation of a building heating system after an extended summer shutdown can cause alarms.
- Building maintenance issues, such as accidental triggering of a detector’s magnetic test switch, or the introduction of plaster dust from drywall repairs into a detector’s sensing chamber can cause unwanted alarms.
- Induced current effects from lightning storms can cause alarms.
- Infestation from insects small enough to enter the detector’s sensing chamber.
- Vandalism or mischievous acts — detectors set off as a prank have been found to be a problem in dormitories.

If an alarm occurs and a fire does not exist, the alarm should be silenced, the problem unit located, and the alarm system controls reset so that the effectiveness of the detection system is restored.

Make sure that all the detectors in the zone or pinpointed device(s) that show an alarm are checked before deciding that it is a false alarm. If a fire does exist, more than one detector may be in the alarm state, although no signs of fire may be evident in the vicinity of the first activated detector. The fire could be overlooked.

**Maintain an Alarm Log**

The next step for all alarms should be entry of a report into an Alarm Log. A typical Alarm Log is shown in Appendix 2 (page 19). Such a log serves immediate and long-term purposes.

The Alarm Log indicates which individuals responded to the alarm and whether or not they took appropriate action.

Periodic review of the cumulative Alarm Log can help those responsible for the detection system discern patterns in the reported alarms. Generally, several months (or even years) of data may be necessary before patterns begin to emerge.

In a worst case example, a pattern of repeated alarms or small fires in a particular area may indicate a serious deficiency in safety practices that should be promptly corrected. In less obvious cases, patterns are indicated by repeated alarms in the same or adjacent zones with similar probable causes, or repeated alarms in the same zone that occur at about the same time of day, or time of year.

**Effects of Location or Environment**

Check for the effects of location and environment. Review the information in this guide Where To Place Detectors and Where NOT to Place Detectors to determine whether the detector’s location or its environment is potentially causing the unwanted alarms. Also, refer to the installation manual for further information.

One often overlooked source of problems is the placement of detectors where air streams carry smoke or chemical fumes from some areas of an installation past detectors in other areas unrelated to the source of the contaminants. Diagnosing problems of this kind requires that air movements into the problem area, especially near the ceiling, be carefully checked and their sources be determined. Experienced heating, ventilating, and air conditioning (HVAC) engineers or contractors usually have the training and specialized equipment (flow meters, etc.) to conduct such a study. In very difficult cases, a full-scale smoke test may be required to solve the problem.

Conversely, strong air streams near air inlet or supply ducts, etc. can also prevent a detector from signaling an alarm when a fire is present by blowing smoke away from the detector heads.

**Inspect Detector for Dirt and Review Maintenance**

If the Alarm Log indicated that after several months or a year with a fairly stable alarm rate, there is a gradual increase in the frequency of unwanted alarms, this is usually an indication that the detectors in the system should be cleaned.

NFPA standards require and smoke detector manufacturers recommend that all detectors be visually inspected twice a year.

Clean the detectors at least once a year, or more frequently if environmental conditions warrant it. See the section on Detector Testing and Maintenance in this guide for more details.

In cases where the probable cause of a number of alarms appears to be dust or dirt on the detectors, detector maintenance schedules should be reviewed to determine the dates when the detectors were last cleaned and tested. If the detectors are due or overdue for maintenance, scheduling and performing the recommended cleaning and testing should eliminate the problem.

If the problem resulted from a temporary overall increase in airborne dust due to nearby construction, scheduling a one-time special cleaning for all the detectors in the system should alleviate the problem. If the problem is confined to one or two zones and is the result of higher dust levels in a particular area, scheduling the detectors in those areas for more frequent maintenance and cleaning may prevent the development of similar alarm problems in the future.

### Effects of Other Systems on Alarm System

In checking for the effects of other systems on the alarm system wiring the Alarm Log may be very valuable in helping to pinpoint relationships among apparently causeless alarms. One important fact that can be obtained from an Alarm Log is the beginning date for a rash of apparently causeless alarms that may or may not be grouped around one particular zone. The sudden onset of such a group of alarms may result when an addition or change in the alarm system or in another electrical or electromechanical system in the building affects the detectors or the alarm system circuitry.

Systems that can affect the alarm system include: other security systems; walkie-talkie; mobile telephones; heating, ventilating, and air conditioning controls; elevator call systems; remote control equipment (door closers, etc.); and even the installation of microwave antenna. If the alarm pattern supports the possibility of some kind of interference with a fairly definite initiation date, all equipment changes made in the building immediately prior to or concurrent with the beginning of the development of the alarm pattern should be reviewed. In addition, the wiring layouts of the alarm system and any recent building or system modifications should be compared to make sure that the spacing and/or shielding required to protect the alarm system wiring from other potentially interfering electrical systems was maintained.

### Miscellaneous Causes of Unwanted Alarms

Isolated alarm causes such as a maintenance person accidentally triggering an alarm by touching a detector with a magnetic screwdriver can be ignored, except to periodically remind maintenance personnel to be careful when working around detectors.

Steps should also be taken to protect detectors from dust whenever maintenance requires sawing, sanding, drilling,

or other dust-producing operations in the vicinity of the detector heads to prevent false alarms due to the dust getting into the detector sensing chambers. In new construction applications drywall dust contamination affects all types of smoke detectors. To help overcome this problem, it is strongly recommended that installation of detector heads be delayed until after drywall installation is completed or to protect detector heads from dust contamination.

If alarms occur whenever the heating system is turned on after an extended shutdown, due to the accumulated dust burning off as the system components heat, the detector system can be turned off for a short period while the heating system is activated and checked out, or the start-up of the heating system can be scheduled for an evening, weekend or other off-hours period to minimize the effects of alarms on regular daytime activities.

Not all unwanted alarms are caused by dirt, interference or other effects on the detectors. If the control panel shows an alarm but no detectors in the zone are indicating an alarm condition, the possibility of interference or a failure of a control panel component should also be investigated.

### Responsibilities of Detector Owners and Installers

The owners of smoke detector-equipped fire alarm systems are responsible for maintaining the integrity of the detection system. This can be accomplished by:

- Maintaining an Alarm Log and training appropriate personnel to properly maintain the system as described above in the section titled What To Do When Unwanted Alarms Occur.
- Maintaining a Detector Maintenance Log that records inspection, testing and cleaning data for each detector in the system. (Refer to Section 6 of this manual – Testing, Maintenance and Service of Detectors for information on recommended testing and maintenance intervals and procedures, and a sample Detector Maintenance Log page.)
- Maintaining a complete file of information on the alarm system in a readily accessible location. This file should include specifications and installation instructions for the detectors, control panel, and auxiliary devices, wiring diagrams and wire location information, and the manufacturer's recommendations for isolating the detection system wiring from other electrical wiring to prevent interference and unwanted alarms.
- Making certain that maintenance personnel or contractors working on the building's electrical systems are given copies of the alarm system wiring layout and locations so that potential interference from other wiring systems can be prevented by proper insulation and spacing during installation.
- Keeping accurate records of installation and modifications to all other building electromechanical systems that could cause interference with the alarm system, including updating schematics, wiring layouts, and wiring location information whenever changes are made, so that problems can be promptly found and eliminated.
- Making a record of everything done during investigation of a series of alarms, indicating a problem exists.

If assistance must be sought from the installer or manufacturer, there will be an indication of the tests that have already been done by the owner's personnel.

These services can be provided by qualified outside organizations.

The installers of smoke detector equipped alarm systems are responsible for providing the owners with the necessary information and training so that their personnel can maintain the integrity of the alarm system. These responsibilities should include:

- Providing copies of the specifications and installation instructions for the detectors, control panel, and auxiliary devices; wiring diagrams and wire location information; and the manufacturer's recommendations for isolating the detection system wiring from other electrical wiring to prevent interference and unwanted alarms.
- Verifying that the alarm system installation meets all applicable code requirements.
- Completely testing a newly installed, expanded, or modified alarm system to ensure that all components are working properly.
- Providing troubleshooting assistance to the owners for a specified break-in period after installation in case problems develop.

- Helping the owner set up appropriate Detector Maintenance and Alarm Logs for the system.
- Providing initial instruction and training to the owner's personnel or outside organization which will be monitoring and maintaining the system.
- Providing troubleshooting assistance if nuisance alarm problems cannot be solved satisfactorily by the owner's personnel or outside organization.

### **Where to Get Help if the Source of Unwanted Alarms Can't be Found**

In the event a series of unexplained unwanted alarms and/or a review of the Alarm Log indicates that a problem situation exists, the owner should conduct the initial investigation to find a solution. If the owner's personnel are unable to determine the cause for the alarms, the installer or representative of the manufacturer should be contacted to help pinpoint the problem.

Manufacturers can be contacted by phone for additional suggestions. If factory assistance is needed, a factory engineer may be able to explain the source of the problem with data from your Alarm Log, complete description of your alarm system including detector model numbers, make and model number of the control panel and other components, and a complete summary of all aspects of the problem that have already been checked.

## Appendix 1

**Glossary of Terms****Addressable System Smoke Detector**

System smoke detectors, which, in addition to providing alarm and trouble indications to a control unit, are capable of communicating a unique identification (address).

**Air Sampling-type Detector**

A sampling-type detector consists of piping or tubing distribution from the detector unit to the area(s) to be protected. An air pump draws air from the protected area back to the detector through the air sampling ports and piping or tubing. At the detector, the air is analyzed for fire particulate.

**Alarm (Signal) Notification Appliance**

An electromechanical appliance that converts energy into audible or visible signal for perception as an alarm signal.

**Alarm Signal**

A signal indicating an emergency requiring immediate action, such as an alarm for fire from a manual box, a waterflow alarm, or an alarm from an automatic fire alarm system, or other emergency signal.

**Alarm Verification Feature**

A feature of automatic fire detection and alarm systems to reduce unwanted alarms, wherein automatic fire detectors must report alarm conditions for a minimum period of time or confirm alarm conditions within a given time period, after being reset, to be accepted as a valid alarm initiation signal.

**Annunciation**

A visible and/or audible indication of system status.

**Automatic Fire Alarm System**

A system of controls, initiating devices and alarm signals in which all or some of the initiating circuits are activated by automatic devices such as smoke detectors.

**Class A Circuit (Loop)**

An arrangement of supervised initiating device, signaling line, or indicating appliance circuits that prevents a single open or ground on the installation wiring of these circuits from causing loss of the system's intended function.

**Class B Circuit (Loop)**

An arrangement of supervised initiating device, signaling line, or indicating appliance circuits, which does not prevent a single open or ground on the installation wiring of these circuits from causing loss of the system's intended function.

**Combination Smoke Detector**

A smoke detector that combines two or more smoke or fire sensing technologies.

**Detector Coverage**

The recommended maximum distance between adjacent detectors or the area that a detector is designated to protect.

**Drift Compensation**

The capability of a detector to automatically adjust its alarm sensitivity to compensate for any changes over time in the factory settings for smoke and/or fire detection. In analog systems, this may be done by the panel.

**End of Line**

A device such as a resistor or diode placed at the end of a Class B wire loop to maintain supervision.

**End of Line Relay**

Device used to supervise power (for four-wire smoke detectors) and installed after the last device on the loop.

**False Alarms**

An unwanted alarm caused by non-smoke contaminants such as dust or insects.

**Fire**

A chemical reaction between oxygen and a combustible material where rapid oxidation results in the release of heat, light, flame and/or smoke.

**Flame Detector**

A device that detects the infrared, ultraviolet, or visible radiation produced by a fire.

**Four-wire Smoke Detector**

A smoke detector which initiates an alarm condition on two separate wires (initiating loop) apart from the two power leads.

**Heat Detector**

A device that detects abnormally high temperature or rate-of-temperature rise.

**Initiating Circuit**

A circuit which transmits an alarm signal initiated manually or automatically, such as a fire alarm box, smoke, heat, or flame sensing device, sprinkler waterflow alarm switch or similar device or equipment to a control panel or any similar device or equipment which, when activated, causes an alarm to be indicated or retransmitted. An Initiating Device Circuit (Loop) is a circuit to which automatic or manual signal initiating devices are connected where the signal received does not identify the individual device operated.

**Initiating Device**

Any manually operated or automatically operated equipment which, when activated, initiates an alarm through an alarm signaling device.

**Intelligent (Analog, Smart) System Smoke Detector**

A system smoke detector capable of communicating information about smoke conditions at its location to a control unit. This type of detector typically communicates a unique identification (address) along with an analog (data) signal, which indicates the level of smoke at its location.

**Ionization Smoke Detector**

An ionization smoke detector has a small amount of radioactive material that ionizes the air in the sensing chamber, thus rendering it conductive and permitting a current to flow between two charged electrodes. This gives the sensing chamber an effective electrical conductance. When particles of combustion enter the ionization area, they decrease the conductance of the air by attaching themselves to the ions, causing a reduction in mobility. When the conductance is less than a predetermined level, the detector responds in a fire alarm condition.

**Light Scattering**

The action of light being reflected and/or refracted by smoke particles for detection by a photoelectric smoke detector. The action of light being refracted or reflected.

**Listed**

Equipment or materials included in a list published by an organization (e.g., Underwriters Laboratories) acceptable to the "authority having jurisdiction" and concerned with

product evaluation, that maintains periodic inspection of listed equipment or materials and whose listing states either that the equipment or material meets appropriate standards or has been tested and found suitable for use in a specified manner.

Note: The means for identifying listed equipment may vary for each organization concerned with product evaluation, some of which do not recognize equipment as listed unless it is also labeled.

**Maintenance Condition**

Method of providing annunciation of a smoke detector that it is out of its listed sensitivity range.

**National Fire Protection Association (NFPA)**

An organization that administers the development and publishing of codes, standards, and other materials concerning all phases of fire safety.

**Nuisance Alarm**

An unwanted alarm caused by smoke from cooking or cigarettes.

**Obscuration**

A reduction in the atmospheric transparency caused by smoke usually expressed in percent per foot.

**Particles of Combustion**

Substances (products that either remain at the site of burning such as ash, or scatter as volatile products) resulting from the chemical process of a fire.

**Photoelectric Smoke Detector**

In a photoelectric light scattering smoke detector, a light source and a photosensitive sensor are so arranged that the rays from the light source do not normally fall on the photosensitive sensor. When smoke particles enter the light path, some of the light is scattered by reflection and refraction onto the sensor, causing the detector to respond.

**Projected Beam Smoke Detector**

In a projected beam detector the amount of light transmitted between a light source and a photosensitive sensor is monitored. When smoke particles are introduced into the light path, some of the light is scattered and some absorbed, thereby reducing the light reaching the receiver, causing the detector to respond.

**Rate-of-rise Heat Detector**

A device which will respond when the temperature rises at a rate exceeding a predetermined amount, usually 15° per minute.

**Remote Maintenance Condition**

NFPA 72 listed method of providing annunciation at the control unit that the smoke detector is outside of its listed sensitivity.

**Smoke Detector**

A device that detects the visible or invisible particles of combustion.

**Smoothing Algorithms**

A method of “smoothing out” a detector’s interpretation of sudden, short-duration increases in obscuration within the sensing chamber, intended to reduce the occurrence of nuisance alarms.

**Spot (Point) Detector**

A device whose detecting element is concentrated at a particular location. Typical examples are bimetallic detectors, fusible alloy detectors, certain pneumatic rate-of-rise detectors, most smoke detectors and thermoelectric detectors.

**Stratification**

An effect that occurs when air containing smoke particles or gaseous combustion products is heated by smoldering or burning material and, becoming less dense than the surrounding cooler air, rises until it reaches a level at which there is no longer a difference in temperature between it and the surrounding air. Stratification can also be caused by forced ventilation.

**Trouble Supervision**

The ability of a fire alarm control unit (FACU) to detect a fault condition in the installation wiring, which would prevent normal operation of the fire alarm system.

**Thermal Lag**

When a fixed temperature device operates, the temperature of the surrounding air will always be higher than the operating temperature of the device itself. This difference between the operating temperature of the device and the actual air temperature is commonly spoken of as thermal lag, and is proportional to the rate at which the temperature is rising.

**Two-wire Compatibility**

Per NFPA 72, 1999 edition: “All fire detection devices that receive their power from the initiating device circuit or use a signaling line circuit of a fire alarm control unit shall be listed for use with the control unit.”

**Two-wire Smoke Detector**

A smoke detector which initiates an alarm condition on the same two wires that also supply power to the detector.

**Unwanted Alarm**

Any false alarm or nuisance alarm.

**Wireless Smoke Detector**

A smoke detector which contains an internal battery or batteries that supply power to both the smoke detector and integral radio frequency transmitter. The internal power source is supervised and degradation of the power source is communicated to the control panel. On stimuli, the detector transmits a radio signal to a repeater or Fire Alarm Control Unit (FACU) that in turn generates a signal or status condition.

**Appendix 2  
Fire Alarm Log**

**Customer Name:** \_\_\_\_\_

**Installation Date:** \_\_\_\_\_

**Installing Contractor:** \_\_\_\_\_

**Inspection and Test Date:** \_\_\_\_\_

**Inspection and Test Performed By:** \_\_\_\_\_

Date	Time	Recorded By	Check one		Location (Bldg, Zone, Det #)	Probable Cause	Action Taken	Action Taken By Name and Date
			Fire	Trouble				





## Free Manuals Download Website

<http://myh66.com>

<http://usermanuals.us>

<http://www.somanuals.com>

<http://www.4manuals.cc>

<http://www.manual-lib.com>

<http://www.404manual.com>

<http://www.luxmanual.com>

<http://aubethermostatmanual.com>

Golf course search by state

<http://golfingnear.com>

Email search by domain

<http://emailbydomain.com>

Auto manuals search

<http://auto.somanuals.com>

TV manuals search

<http://tv.somanuals.com>