



USER MANUAL

K1 AV



For your own safety please be sure to read right through these operating instructions. It is especially important to observe the directions regarding setting up and operating the equipment, and the safety notes.



This product fulfils the low voltage directives (73/23/EEC), the EMV directives (89/336/EEC and 92/31/EEC) and the CD marking directive (93/68/EEC).

Welcome.

We are delighted that you have purchased a **T+A** product. The **K1 AV** is a superb piece of equipment whose overall design and comprehensive facilities have been developed with the requirements of the audiophile music lover as top priority.

Solid, carefully thought-out design, the synthesis of a user-friendly control philosophy and a set of technical features which simply leaves nothing to be desired; all this combined with carefully selected components and materials of the highest quality ensure that this machine will fulfil your most exacting requirements over a period of many years.

Stringent quality control of all materials, painstaking production by qualified technical staff, and a final, fully automatic computer-controlled checking process ensure consistently high product quality and the maintenance of all specifications.

In our equipment production processes we avoid the use of materials which are environmentally harmful and injurious to health, such as chlorine-based solvents and CFCs. As far as possible we avoid the use of plastics - especially PVC - in our equipment; instead we use metals or other non-harmful materials which are easily recycled and also provide effective electrical shielding.

The heavy, all-metal case of the **K1 AV** eliminates the possibility of external sources of interference adversely affecting reproduction quality.

This reliance on metal also ensures that electro-magnetic radiation (electro-smog) generated by the machine is effectively shielded, and reduced to an absolute minimum.

We are grateful to you for placing your faith in us, and hope that you will enjoy many hours of pleasure with your **T+A K1 AV**.

T+A elektroakustik



CAUTION !

This device contains a laser diode classed higher than category 1. To guarantee safe operation for an indefinite period it is not permissible to remove any covers, nor to attempt to gain access to the interior of the machine in any other way. Maintenance work must be carried out exclusively by qualified technical servicing personnel.

The following warning labels are attached to the machine:

On the back panel:

**CLASS 1
LASER PRODUCT**

On the inner shielding cover of the DVD mechanism:

CAUTION:	VISIBLE AND INVISIBLE LASER RADIATION WHEN OPEN. AVOID EXPOSURE TO BEAM
VORSICHT:	SICHTBARE UND UNSICHTBARE LASERSTRAHLUNG, WENN ABDECKUNG GEÖFFNET NICHT DEM STRAHL AUSSETZEN
ATTENTION:	RAYONNEMENT LASER VISIBLE ET INVISIBLE EN CAS D'OUVERTURE EXPOSITION DANGEREUSE AU FAISCEAU
DANGER:	VISIBLE AND INVISIBLE LASER RADIATION WHEN OPEN. AVOID DIRECT EXPOSURE TO BEAM

About these instructions

All the controls and functions of the **K1 AV** which are frequently used are described in the first section of these operating instructions.

The second part - 'Basic settings, Installation, Using the K1 AV for the first time' covers connections and settings which are very seldom required; they are generally required only when the machine is set up and used for the first time.

Symbols used in these instructions



Text passages marked with this symbol contain important information which must be observed if the machine is to operate safely and without problems.



This symbol marks text passages which provide supplementary notes and background information; they are intended to help the user understand how to get the best out of the machine.

Italic

Technical terms printed in italics are explained in detail at the end of the instructions.

Contents

Operating the K1 AV

Front panel controls	6
Operating the K1 AV by remote control	8
The amplifier	10
Basic functions	10
Multi-room mode	11
Amplifier menu	11
• Balance	13
• Treble	13
• Bass	13
• Loudness	13
• Bass (low bass lift)	14
• Sub-woofer volume	14
• Centre volume	14
The tuner	15
Basic operation	15
Alarm timer	16
Special tuner functions	16
• RCV (reception types)	17
• Presets	18
The disc player	20
Special functions	21
Manual cursor control	21
Playing MP3 / JPEG / Picture CDs	22
Compatible formats	23
Compatibility with recordable media	23
Basic disc player settings	24
Player setup menu	25
• General setup menu	26
• Audio setup menu	27
• Video setup	29
• Basic settings	31
Basic settings, Installation, Using the K1 AV for the first time	
Amplifier Setup Menu	34
• Main loudspeakers	36
• Centre loudspeaker	36
• Sub-woofer cut-off frequency	36
• Volume setting, separate	37
• Screen brightness	38
• Clock (automatic setting via RDS)	39
• Setting the time	39
• Time display brightness	40
• AUX input sensitivity	40
Sockets	42
Setting up the K1 AV	43
Wiring	44
F6 remote control handset	45
• Replacing the batteries	45
• Switching the remote control address	45
Wiring diagrams.....	46
Safety notes	47
Glossary	49
Trouble-shooting	52
Specification	56

Front panel controls

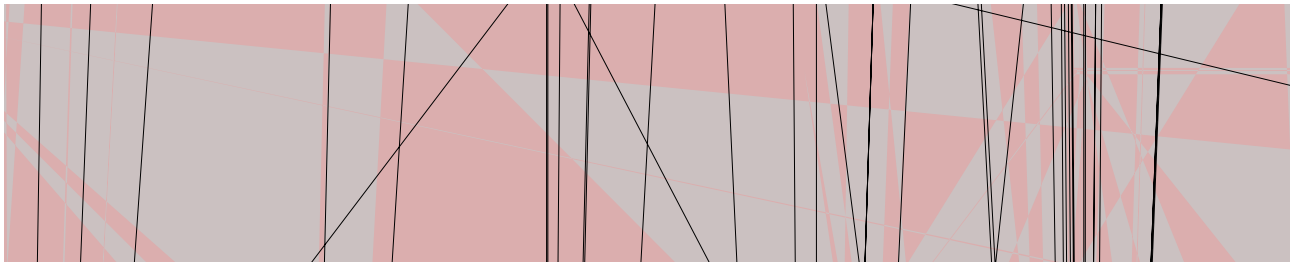

① Disc drawer

The drawer of the **K1 AV** is made of a material with very high acoustic damping characteristics. Its flexible, floating support system eliminates the transmission of mechanical vibration to the disc, which would otherwise have an adverse effect on sound quality.

You will find information on inserting the disc and compatible disc formats in the chapter '*The disc player / Compatible formats*'.

② HEADPHONES

Barrel socket (3.5 mm Ø) for stereo headphones with an impedance of at least 30 Ω.



When listening via headphones the surround mode STEREO should always be selected, otherwise the centre channel information will be lost (see chapter '*The amplifier / Basic functions, surround modes*').

④ ON

The machine's On / Off button.

When you switch the **K1 AV** on, the screen displays the selected listening source of a machine-specific message. When switched on, the machine always reverts to the setting in which it was last auditioned. The volume is limited to 'room volume' when switched on.



Caution:

The On / Off button on the front panel is not a mains isolation switch, and a few of the machine's sub-assemblies remain connected to the mains supply when it is switched off. If you know that the system will not be used for a protracted period, we recommend that you isolate it from the mains power supply by disconnecting the mains plug from the wall socket.

Auto-Off function (disc mode only)



The **K1 AV** features an automatic power-off function in disc mode. If the player goes into 'STOP' mode at the end of playing a disc, and if no controls are operated in the next twenty minutes, the **K1 AV** automatically switches itself off.

⑤ Source select

Pressing this button selects the listening source you wish to use. Press the button repeatedly until the screen displays the source to which you wish to listen.

The signal from the selected source can now be played via the loudspeaker groups A and B. The same signal is also present at the **TAPE-OUT** output sockets for recording.

⑥ Monitor

Pressing this button toggles between the currently selected listening source and the tape monitor signal of a recording device connected to the **K1 AV**. Press it a second time to return to the original signal.

When the tape monitor signal is being played, the  symbol glows on the screen.



For more information on the MONITOR function please refer to the chapter '*The Amplifier / Basic functions, Monitor*'.

⑦ (Stop) / (Open)

Pressing this button ends disc playback (STOP).

When the disc has stopped playing, pressing this button opens and closes the disc drawer (OPEN).



If you wish to open the drawer while the disc is playing, hold the button pressed in until the screen displays the message 'OPEN'. The drawer now opens as soon as the disc has stopped spinning.

8  (PLAY/PAUSE) /  (Timer)

Combi-button for starting the disc and activating the timer.

In disc mode:

brief press: **PLAY**
Starts the disc from the operating mode 'STOP'.

long press: **PAUSE**
Temporarily halts disc playback. Pressing the same button again resumes playback.

In Tuner mode:

When the tuner is in use, this button is used to switch the alarm timer on and off.

 See the chapter 'The tuner / alarm timer' for an explanation of the Timer function.

9 

Combi-button for skipping to the next or previous track during disc playback, or for switching presets in tuner mode.

During disc playback:

brief press: Skips to the start of the next track.
long press: Skips to the start of the previous track.

Im Tuner Betrieb:

brief press: Selects the next *preset*
long press: Selects the previous *preset*

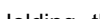
 Holding the  button pressed in skips backwards by several tracks or *presets*. Simply hold the button pressed in until the desired track or *preset* appears on the screen.

10  Volume

Every time you briefly press one of the **VOLUME** buttons, the volume is increased (+) or reduced (-). The current volume is also displayed for a few moments on the screen. If you hold a Volume button pressed in for longer than about one second, the volume alters continuously until you release the button again.













The enormous volume range (0 ... 78.75 dB) and the perfectly even graduations provide extremely fine and accurate volume control.

When you are programming the Timer, these buttons are also used to change the alarm time.

3 **Screen**

All the display elements of the **K1 AV** are grouped together in a single, clearly arranged screen window.







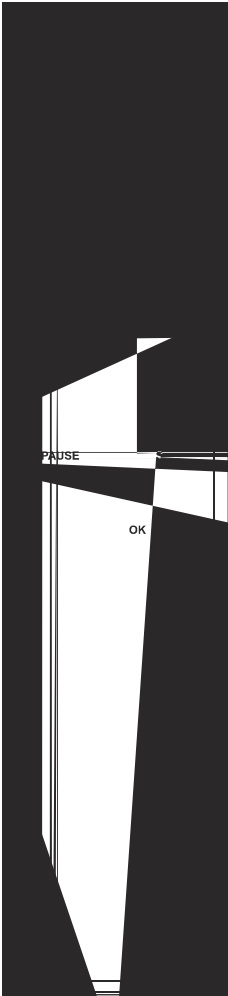























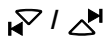
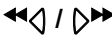

	Alpha-numeric display field for displaying information such as track title, playing time or operating mode. Context-sensitive messages are also displayed here, such as when operating the ' Amplifier menu '.
	Loudspeaker group A (main room) Glow when loudspeaker output  A is switched on.
	CENTRE (main room) Glow when the Centre loudspeaker output is switched on.
	Loudspeaker group B (adjacent room) Glow when loudspeaker output  B is switched on.
	LOUDNESS Glow when the volume-dependent loudness control is switched on.
	Glow when low bass lift is switched on.
	TIMER Glow when the alarm is active (see the chapter ' The tuner / alarm timer ').
	Repeat (repeat function) Glow when a disc is playing in Repeat mode.
	Glow when tape monitor function is switched on.
	Field strength display The field strength, and the reception quality you can expect from the selected station, can be assessed by observing this symbol: if the symbol lights up, hiss-free mono reception should be possible. If you set such a station to stereo reception, slight background hiss may be audible.
	Stereo indicator Glow when the selected station is broadcasting a stereo programme. The indicator does not light up if the station is only broadcasting a mono programme, or if you have manually set the tuner's reception mode to MONO (see the chapter ' Special tuner functions / RCVM MONO ').

Remote control of the K1 AV



The **F6** remote control handset controls all the functions of the **K1 AV**. The adjustments you make are displayed on the machine's integral screen and also on any TV set which is connected to the system.

	<p>ON</p> <p>This button switches the K1 AV on and off.</p> <p> If the system is being operated in single-room mode, the loudspeaker outputs A and B are always at the setting which was last used when the machine is switched on.</p> <p>If the system is set to multi-room mode, only the speakers in the operator's room are switched on; the other pair of loudspeakers are muted.</p>
 	<p>Volume control</p> <p>Rocker switches for volume control: a brief press changes the volume by one increment. If the rocker is held in one position, the volume changes continuously until it is released again. The screen briefly displays the current volume value.</p>
	<p>Loudspeaker outputs</p> <p>This button toggles the loudspeaker outputs on and off. The speaker groups are switched OFF in the following sequence: A (main room), B (adjacent room), A + B (main and adjacent rooms), OFF. The corresponding symbols light up on the K1 AV's integral screen to indicate the current operating mode.</p> <p> A long press on the  button switches all the loudspeaker groups off directly (Mute setting).</p>
    	<p>Selecting the listening source</p> <p>Pressing a source button selects the corresponding device as the listening source, even if the K1 AV was previously switched off. The signal from this source is then reproduced by the system. It is only possible to remotely control the device which is currently selected as the listening source.</p> <p> Selects the integral disc player.</p> <p> Selects the integral tuner.</p> <p> Selects the AUX input.</p> <p> Selects the TAPE input (recording device).</p> <p> Selects the TV set connected to the Scart socket.</p> <p> When you switch to a new listening source, the screen briefly displays the new source. After this it reverts to a standard machine-specific display.</p>
	<p>Playback mode</p> <p>Cycles through the playback modes when the button is repeatedly pressed.</p> <p>STEREO Stereo playback via the left and right loudspeakers</p> <p>MUSIC Three-channel music playback (left, right, centre)</p> <p>MOVIE Three-channel film reproduction (left, right, centre)</p> <p> It is only possible to set the playback mode if a Centre loudspeaker is present in the system, and if it has been activated in the 'Amplifier Setup menu / Centre loudspeaker'.</p>
	<p>brief press: Amplifier</p> <p>long press: Amplifier Setup menu</p>

	In Disc mode	In Tuner mode
	<p>brief press: when playing a CD the screen can be toggled between track display and display of playing time.</p> <p>long press: in conjunction with a Metz TV this switches the screen off, e.g. with music CDs or DVDs</p>	
	<p>Skip track Cursor navigation in menus Mirror the picture (Picture Disc)</p>	<p>Preset select Calls up the preset with the next smaller / larger number; vacant memories are automatically skipped.</p>
	<p>Rewind / Fast forward Cursor navigation in menus MP3-CD: selects the previous / next album Picture Disk: rotate picture</p>	<p>brief press: manual tuning Changes the reception frequency by one 25 kHz step up / down</p> <p>long press: starts Station search.</p>
	<p>Start playback (PLAY) During playback: brief press: ends operating mode: PAUSE / SEARCH / SCAN</p> <p>long press: switches to cursor control (see chapter '<i>The disc player - manual cursor control</i>').</p>	<p>If you press this button instead of the RDS station name, the current preset number and the associated reception frequency are displayed for about one second.</p>
	<p>brief press: halts playback (PAUSE)</p> <p>Repeated press: continues with DVD single frame</p> <p>llong press: slow motion: $\frac{1}{2}$, $\frac{1}{4}$, $\frac{1}{8}$ speed</p>	
	<p>brief press: stops playback (STOP)</p> <p>long press: opens drawer</p>	<p>Halts station search</p>
	<p>Numeric buttons Direct track / chapter select</p>	<p>Numeric buttons Direct preset select</p>
	<p>Switch REPEAT modes</p>	
	<p>brief press: switches sound track (DVD)</p> <p>long press: camera angle (DVD)</p>	
	<p>brief press: opens Disc menu (see chapter '<i>Disc player - during playback</i>')</p> <p>long press: switches DVD SETUP menu on (see chapter '<i>The disc player - basic settings</i>')</p>	<p>Opens Special tuner functions menu (see chapter '<i>Special TUNER functions</i>')</p>
	<p>Switches sub-title language, switches sub-titles off</p>	<p>Switches Radiotext on / off</p>

The Amplifier

All the functions described in this chapter apply to the amplifier section of the **K1 AV**. They are available for all source devices, i.e. both for the integral disc player and tuner and also for external machines connected to the receiver.





The basic amplifier functions can be controlled directly using the buttons on the front panel or those on the remote control handset. Seldom required functions such as the Balance and Tone controls are grouped together in a Setup menu ('Amplifier menu').

Basic settings, which are generally only required once when the **K1 AV** is installed, are adjusted using the Amplifier Setup menu; see chapter 'Basic settings / Installation / Using the K1 AV for the first time'.

Basic functions

Switching on

The **K1 AV** is switched on and off using the On / Off button () on the front panel or on the remote control handset.

It can also be switched on directly using any of the source buttons on the remote control handset ( /  /  /  / .

Selecting a listening source

Select the desired listening source with the .

Surround mode



 The **K1 AV** is equipped with an analogue room sound processor. Basically it can be operated with two or three loudspeakers in the main room. Three speakers (Left / Centre / Right) provide a more natural and spacious playback overall, eliminating the "acoustic hole" in the middle. When you are playing a film, the third speaker also helps to localise speech and sound events on the screen.

If the **K1 AV** is operated with two loudspeakers (left / right), then only the STEREO mode is available.

If a Centre loudspeaker is present, the **K1 AV** can be switched between the playback modes **STEREO**, **3-CH MUSIC** and **3CH MOVIE** by repeatedly pressing the  button on the remote control handset.

For music playback we recommend the modes STEREO or 3CH MUSIC, and for film playback the mode 3CH MOVIE.

The **K1 AV** remembers the surround mode you last used for each source, and reverts to it next time you switch to the same source. For example, if you select 'STEREO' for the tuner, then the **K1 AV** automatically reverts to stereo mode next time you select the Tuner source.

 DVDs can also be played optionally in **Virtual Surround** mode (see chapter '*The disc player / Player setup menu / Audio setup menu*'). If you activate Virtual Surround for the disc player, you can use the  button to select whether the sound is to be reproduced via two or three loudspeakers.

button on the front panel, or using one of the source device buttons on the remote control handset.

Volume

The volume can be set either on the machine or using the VOLUME buttons () on the remote control handset.

A brief press on the buttons changes the volume by one increment (1.25 dB). Holding the button pressed in causes the volume to change continuously.





The **K1 AV** features loudspeaker outputs for two listening rooms or zones. The volume can be set separately or in common for both zones (see chapter '*Multi-room mode*').

MONITOR

The MONITOR function of the **K1 AV** is designed to allow you to monitor the recording process when using a tape or cassette recorder, provided that your recorder features a 'tape monitor' button.

If you wish to make a recording, select the source device to be recorded as described under 'Select listening source'. Start the recording process on your recorder.

A long press on the  button now switches to the recorder's tape monitor signal while the recording continues. In this way you can check the quality of the recorded signal while the recording process is still under way.

When you switch to tape monitor the screen of the **K1 AV** briefly displays the message 'MONITOR', and the monitor indicator lamp  lights up.

To halt the monitor function, press the  button again briefly. For a moment the screen displays the message 'SOURCE', and the monitor LED goes out. You are now hearing the direct signal of the source device again.



If you switch the monitor function on when there is no audio recorder with monitor facility connected and set to record mode, the loudspeakers will be muted.

Multi-room mode

The **K1 AV** can supply sound to a second room (e.g. your office or the kitchen - multi-room mode) in addition to the main listening room. Alternatively it can deliver sound to a second zone in the main room (multi-zone mode).

The **K1 AV** can be remote-controlled from the main room using its integral remote control receiver, and can also be remote-controlled from the second listening area using an external E2000 remote control receiver.

If the **K1 AV** picks up a volume command via the external remote control receiver, it will either control the volume of the loudspeaker group B (VOL A/B, multi-room mode) or the volume of the loudspeaker groups A and B in common (zone mode) (see chapter '**Amplifier setup menu / Volume setting, separate**').

For the adjacent room the following limitations apply:

- It is only possible to listen to the same source as the one selected in the main room.
- The difference in volume is limited to 38.75 dB.

In all other respects the use of the system in the main room is not affected by its use in the adjacent room.



The method of connecting and wiring the additional components for multi-room and multi-zone operation is described in the chapter '**Wiring diagrams**'.

Amplifier menu

The Amplifier menu groups together the Balance and Tone control functions of the **K1 AV**.

The Amplifier menu is opened with a brief press on the yellow **AMP** button on the **F6** remote control handset. The **K1 AV**'s integral screen now displays the first menu point '**BAL**' (= Balance). You can now use the **◀◀** and **▶▶** buttons on the remote control handset to adjust the balance to left or right. The current value is displayed on the screen.

Press the **↶** and **↷** buttons to call up the other menu points; the set values are changed as described above.

An overview of the Amplifier menu and its adjustment facilities is shown in the picture on the next page. The individual menu points and their adjustment facilities are described in detail in the following section.



Basic settings for the amplifier section of the **K1 AV**, such as *Loudspeaker configuration*, *Bass management* etc. are adjusted in the Amplifier Setup menu, which is described in detail in the chapter '**Basic settings, Installation, Using the K1 AV for the first time**'.

The Amplifier Setup menu is opened with a **long** press on the yellow **AMP** button on the **F6** remote control handset.

Amplifier menu

Adjustment facility

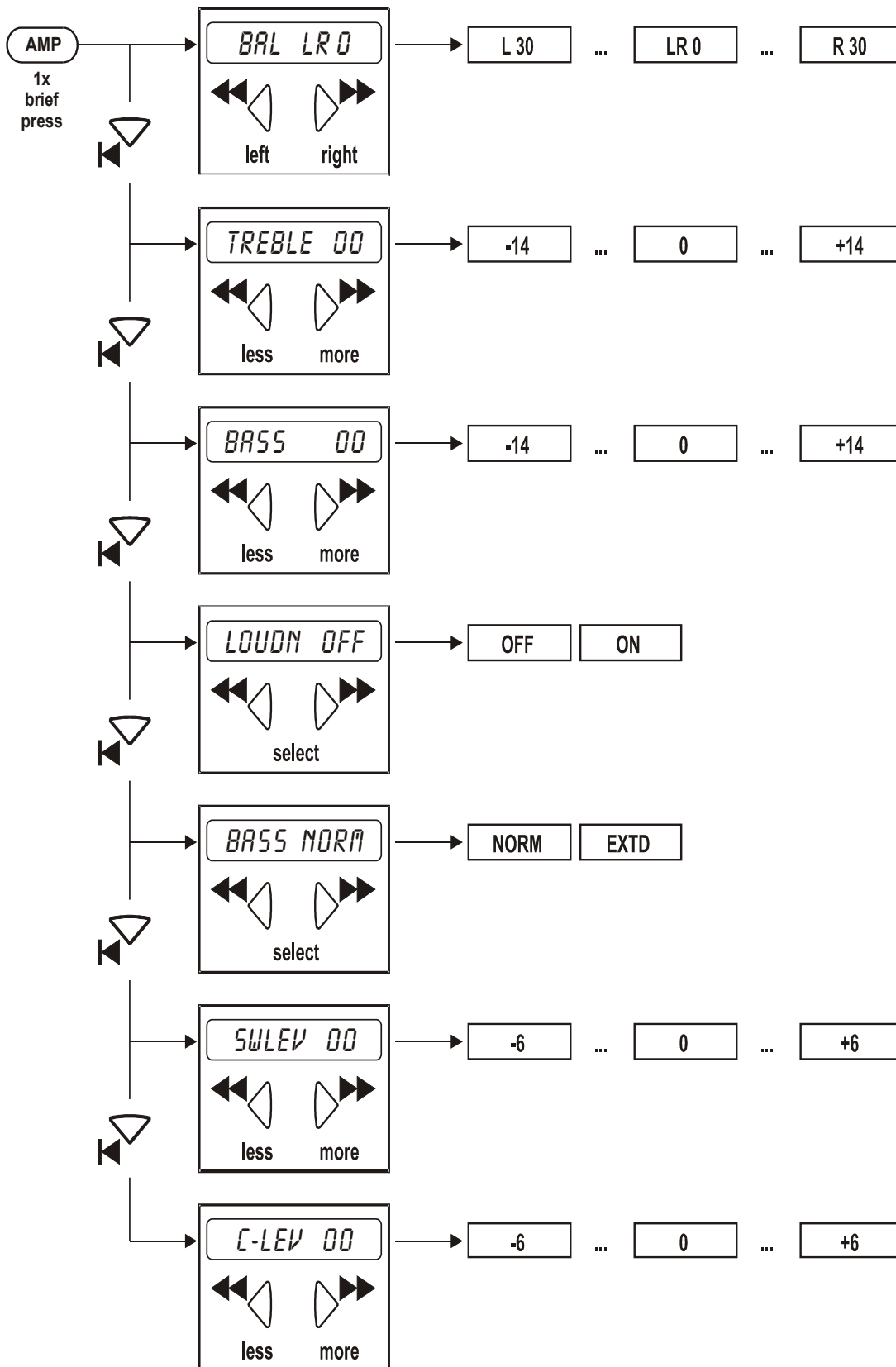

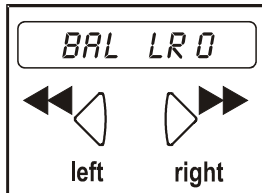

Amplifier menu point **Balance (BAL)**

Explanation:

The '**BALANCE**' function is used to adjust the balance in volume between the left and right channels, e.g. if the loudspeakers are not set up symmetrically.

Operation:

The current setting can be shifted to left or right in small increments using the ◀◀ or ▶▶ button. The screen shows the pre-amplifier's current Balance setting, e.g.:

'BAL LR 0' (= stereo centre neutral)

Available adjustment range:

'BAL L 30' (= stereo centre fully left)

to

'BAL R 30' (= stereo centre fully right).



If the stereo centre is not set to neutral, the offset is shown on the screen every time you alter the volume, e.g. 'VOL 27 L', i.e. the stereo centre is offset to the left.

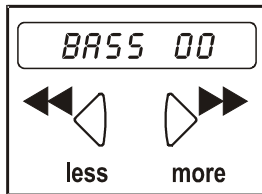
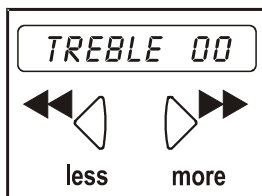

Amplifier menu point **Treble**

Amplifier menu point **Bass** (tone controls)

Explanation:

The unit features active tone controls which can be used to compensate for adverse effects on sound quality caused by unfavourable loudspeaker positions or room influences.

Operation:

The tone controls can be altered over the range:

- 14 dB (less bass / treble)

to

+ 14 dB (more bass / treble)

using the ◀◀ and ▶▶ button.

The screen shows the current bass and treble setting of both stereo channels, e.g.

'TREBLE+04' or 'BASS +02'

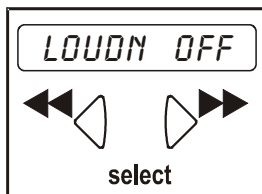

Amplifier menu point **Loudness**

Explanation:

The amplifier features a volume-dependent tone control (**LOUDNESS**), which is designed to compensate for the frequency-dependent sensitivity of the human ear at very low volumes. This maintains a balanced impression of sound volume at very low listening levels.

Operation:

Loudness can be switched off ('OFF') and on ('ON') using the ◀◀ and ▶▶ buttons.

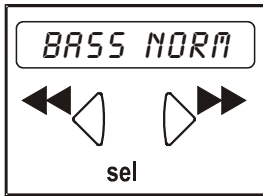

Amplifier menu point **BASS (low bass lift)**

Explanation:

The system features the facility to switch on active low bass lift, producing better deep bass reproduction especially with small, compact loudspeakers.

Operation:

The low bass lift is switched off using the ◀◀ button (display '*NORM*') and switched on with the ▶▶ button (display '*EXTD*').

At the '*BASS NORM*' setting the low bass lift is switched off (correct setting for large loudspeakers); at the '*BASS EXTD*' setting it is switched on (correct setting for compact and bookshelf speakers).



The screen displays a glowing ~ symbol when low bass lift is switched on.



Amplifier menu point **Sub-woofer volume (SWLEV)**

Explanation:

The **K1 AV** offers the facility to adjust the volume level of the sub-woofer (if present in the system).

Operation:

The value can be set within the range -6 to +6 using the change buttons ◀◀ / ▶▶.



This menu point only appears if the sub-woofer is switched on in the '*Amplifier setup menu / Sub-woofer cut-off frequency*' menu.

Amplifier menu point **Centre volume (C-LEV)**

Explanation:

The **K1 AV** offers the facility to adjust the volume of the Centre loudspeaker (if present in the system) to match that of the primary speakers. Adjust the level of the Centre speaker so that it is as loud as the main loudspeakers.





The Centre loudspeaker is intended to fill the 'acoustic hole' between the main loudspeakers; it should not be dominant.

Since the optimum volume of the Centre loudspeaker varies greatly with the playback mode (3CH Music / 3CH Movie), the value set here is stored separately for Music and Movie modes.

Operation:



Use the ◀◀ / ▶▶ buttons to increase or reduce the volume of the Centre loudspeaker in 1.25 dB increments by up to 7.5 dB (screen displays '*-6*' ... '*+6*').

The Tuner

For all the functions described in this chapter the Tuner must be selected as the listening source. First switch the **K1 AV** to Tuner mode by pressing the  button on the front panel, or the  button on the remote control handset.

Basic operation

Selecting presets

Stored radio stations (*presets*) can be selected using the  buttons on the remote control handset, or with the  button on the front panel.

A brief press on the  button on the front panel switches to the next higher preset. To select the next lower preset the button must be held pressed in for longer.

Direct preset selection using the numeric buttons 0 ... 9

If you press one of the numeric buttons on the remote control handset the screen displays a letter 'P' for PRESET, followed by the number just pressed. If you press a second numeric button within about two seconds, then the **K1 AV** accepts this as the second digit of the preset number.

If you do not press a second button, the preset is assumed to be a single-digit number. The preset is activated once the second digit has been entered, or the waiting period has elapsed.

The **K1 AV** ignores invalid preset numbers (xx smaller than 01 or greater than 60); the screen displays 'Pxx ERROR'.

Vacant presets are also ignored; they are indicated on the screen as 'Pxx - - - -'.



If you change to a new preset, and the current station is broadcasting RDS information, the screen displays the station name. Otherwise the screen initially shows the new preset number and the reception frequency. After about one second a tuning display (**Tuning indicator**) replaces the preset number.

Manual fine-tuning

A brief press on the  buttons on the remote control handset adjusts the reception frequency upwards or downwards in fine increments of 25 kHz.

If you hear interference on a particular station, fine-tuning may improve reception; this is done by altering the reception frequency slightly.

Station search

To initiate the station search in the upward or downward direction hold the  button pressed in until the search starts. The frequency display on the **K1 AV**'s screen now cycles up or down until it locates a station.

This process is used to set all the receivable stations. We recommend that you store radio stations which you often listen to in the form of *presets* (see chapter '**Special tuner functions / Presets**').

RDS Radiotext

A brief press on the  button on the remote control handset switches the *Radiotext* display for the currently selected station on and off.

When the machine is switched on, the screen displays the message '**RADIOTEXT**' until a new item of news is displayed.

If the tuner cannot pick up Radiotext information from the selected station, the screen displays the message '**NO RTEXT**' for about one second, and then reverts to the normal display.

If you switch Radiotext off, the screen briefly displays the message '**NO RTEXT**'.

If you switch stations, the Radiotext display is automatically ended. If you wish to re-activate it, you must press the  button again briefly.

Alarm Timer



The **K1 AV** features an integral timer module (Timer), which can be used to switch on the Tuner source at a programmable time (Radio alarm clock)..

Programming the Timer

To program the Timer first select the TUNER as listening source. You now have to set up the **K1 AV** in the way in which you wish it to wake you (radio station, alarm volume, loudspeakers A or B). When the Timer is programmed, the **K1 AV** will use the current settings for its alarm.

To set the alarm time press the  button on the front panel. The screen now displays the current set alarm time, e.g. '14-38 TIM'; the word 'TIM' (TIMER) flashes.

h you can set the alarm time using the **VOLUME +/-** buttons on the front panel. Holding the buttons pressed in increases the rate of change.

When the desired time is shown on the screen, hold the  button pressed in for about one second. The screen briefly shows the alarm time and 'SET' (instead of 'TIM'), e.g. '14-38 SET'. The alarm timer is now switched on and active. The  symbol glows constantly on the screen to indicate that the alarm timer is active.

You can now switch the **K1 AV** off. As long as the  symbol is lit on the screen, the **K1 AV**

i cc

007%h 9v2 V e

Tunermenuü

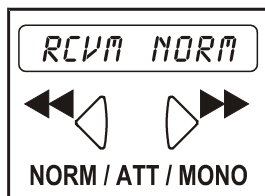
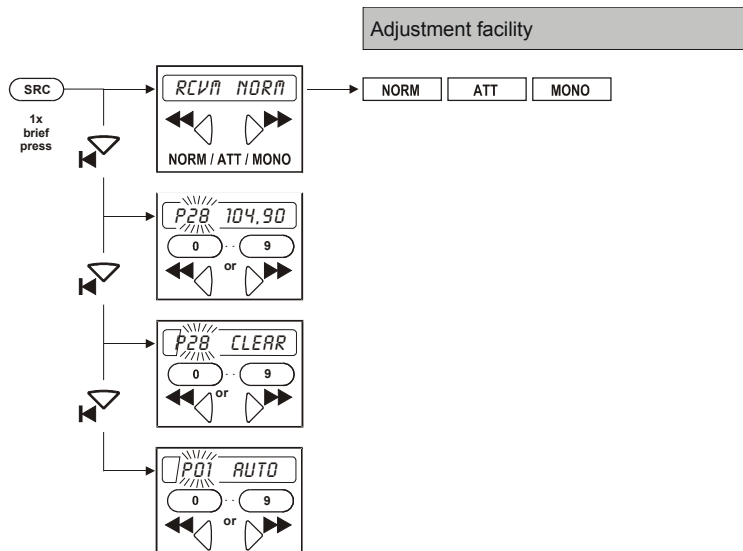

Tuner menu point **Reception modes (RCVM)**

Explanation:

The Tuner can be switched to any of three different reception modes (English: **ReCeIVeMode = RCVM**):

The basic setting of the Tuner is STEREO (**RCVM NORM**). In this reception mode interference from adjacent stations is very effectively suppressed, and even under difficult reception conditions an outstanding quality of reproduction is normally achieved.

When picking up stations close to an unusually powerful local station you may hear intermodulation effects (whistling and twittering sounds). In such cases we recommend that you switch on the aerial attenuator - screen display: '**RCVM ATT**'.

With very weak or very distant stations, which can only be received with considerable background noise, it is also possible to switch to MONO reception, which reduces the background hiss considerably. In the reception mode '**RCVM MONO**' the search threshold is automatically reduced. The automatic station search now also stops at distant, weak and slightly noisy stations.

Operation:

The first step is to call up the menu point '**RCVM**' on the screen by pressing the blue **SRC** button. The current reception mode is displayed after RCVM:

Reception mode	Display:
normal STEREO	RCVM NORM
normal STEREO with aerial attenuator MONO	RCVM ATT
MONO	RCVM MONO

Press the **◀◀ / ▶▶** buttons on the remote control handset to change the reception mode. Select the mode in which the desired station is picked up best, then close the menu by briefly pressing the **SRC** button.



) If you wish to listen to any particular station fairly often, we recommend that you store it as a **PRESET** once you have selected the best reception mode. When you store the preset, the reception mode is stored at the same time. If you then call up the station in the future by selecting the appropriate preset, you will not need to use the Special Functions menu each time to set the reception mode.

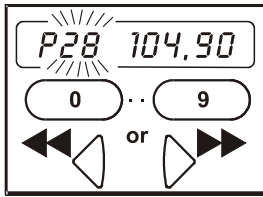

Tuner menu point **Manual storing**

Explanation:

The tuner can store a total of **60 station settings** (presets). In addition to the station frequency, the storing process also records your chosen reception mode and the RDS station name, provided that the latter was received in full at the time the information was stored.

When you call up a preset the tuner reverts to exactly the setting which was selected when the preset was initially stored.

Operation:

Before storing a preset the station must first be tuned in as accurately as possible. If the station broadcasts RDS data, you should wait until the complete RDS station name appears on the screen, as this is stored at the same time as the other information.

Now press the blue **SRC** button and to call up the menu point '**Manual storing**' on the screen.

The screen now shows a '**P**' on the left, followed by a flashing number and the reception frequency, e.g.: '**P28 104,90**' MHz

The flashing number is the preset number under which the currently set station will be stored. The preset number can be changed using the and buttons, or entered directly using the numeric buttons.

To store the setting under the current preset number you must press the **OK** button. The screen displays the message '**STORE**' for a few moments instead of the tuned frequency. This action stores the preset, and the **MANUAL STORE** function is concluded.



The machine responds to any attempt to store an invalid preset number (xx) with the screen message '**Pxx ERROR**'; the tuner then interrupts the Special Functions menu.

Many stations broadcast the station name as a running script, which is contrary to the RDS norm. In such cases you should not store the preset until the transmitter is broadcasting its station name constantly for a fairly long period.

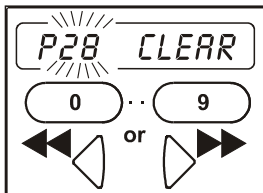

Tuner menu point **Erasing a preset**

Explanation:

Presets containing stations of very poor quality, or the same stations on different frequencies, should be erased.

Under certain circumstances, e.g. after a house-move, it may be necessary to erase all the presets. For information on this please read the '**Tuner**' section under '**Trouble-shooting**'.

Operation:

This is the procedure for erasing a preset:

First call up the preset to be erased using the / buttons, or the numeric buttons. Now press the following buttons on the remote control handset in sequence: **SRC** and 2 x .

The screen now displays a letter '**P**' and the flashing number of the preset to be erased, followed by the function name '**CLEAR**' e. g.: '**P28 CLEAR**'



If you wish to change the number of the preset to be erased, you can do this now using the and buttons, or the numeric buttons 0 ... 9.

To erase the preset press then the **OK** button. This action erases the preset, and the Special Functions menu is closed.



The machine responds to any attempt to erase an invalid preset number (xx) with the screen message '**Pxx ERROR**'; the tuner then interrupts the Special Functions menu.

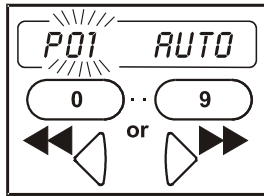

Tuner menu point **Automatic storing (Autostore)**

Explanation:

When you select automatic storing the tuner searches the entire VHF band for stations which can be received well in STEREO mode, and automatically stores the located stations. It carries out the process twice using different search thresholds.



This process may take a considerable time, as the tuner attempts to pick up the complete RDS station name for each transmitter it locates, and store the name at the same time.

If the **AUTOSTORE** function does not detect the RDS station name, but the tuner subsequently picks it up when you are listening to the preset station, then the station name will appear on the screen, and is then automatically stored with the preset.

Operation:

This is the procedure for carrying out the **AUTOSTORE** function:



Press the following buttons on the remote control handset in sequence: **src** and 3 x .

As with manual storing you can now use the  and  buttons or the numeric buttons to select a preset number as the initial number, i.e. the located stations will be stored starting with this number.

If the whole of the station memory is to be used, simply select the number '01'.

Now start the **AUTOSTORE** function by pressing the **ok** button. The frequency display starts counting upward, and the stations located are stored. As soon as the entire VHF band has been searched, or when all the memory space is filled, the machine closes the Special Functions menu.



The **AUTOSTORE** function can be interrupted at any time by pressing one of the tuning buttons ( or ).



Since the tuner is unable to assess the quality of the individual stations it receives, it is also possible to call up the automatically stored presets and fine-tune them to your personal preference.

This also applies to stations whose full **RDS** station name is not detected during the **AUTOSTORE** function, or was not broadcast by the station in accordance with the RDS norm.



To fine-tune the stations, call up each preset in turn and attempt to improve the reception quality by changing the reception mode (**NORM / ATTENUATOR / MONO**). Wait until the correct RDS station name appears on the screen. Now re-store the preset manually (see '**Manual storing**').

Presets containing stations of poor quality, or stations which are already stored on a different frequency, should be erased (see '**Erasing a preset**').

If you repeat the **AUTOSTORE** function, frequencies already stored will not be stored a second time.

The disc player

For all functions described in this chapter the **disc player must be selected as the listening source**.

The first step is therefore to switch the **K1 AV** to disc player mode by pressing the  button on the front panel, or the  button on the remote control handset.

Inserting and playing a disc

Press the  button on the front panel to open the drawer.

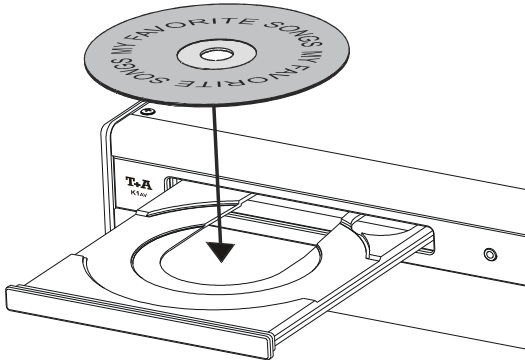

Place the disc **centrally** in the appropriate recess in the disc drawer, **with the side to be played facing down**.



Press the  button on the front panel to close the drawer. When the drawer is closed the machine reads the disc. Once read, the disc can be started.

 If you see the message 'UNKNOWN' on the screen after the disc is read, then the disc in the drawer is a format which the **K1 AV** is unable to play (see chapter 'Compatible formats' at the end of the chapter).

Starting the disc

If the disc in the drawer is a **Music CD** or a **Video CD** (VCD, S-VCD) you can start playback after the machine has read the disc by pressing the  button on the front panel, or the  button on the remote control handset.

The behaviour of a **DVD** after it has been read is determined by the DVD itself, and may vary slightly from one disc to another. In most cases an introductory message appears on the screen when the DVD has been read, followed by a menu (*DISC MENU*).

You can navigate within this menu using the *cursor* buttons, and select various points such as language, sub-titles and sound format. To activate or select a menu point, use the *cursor buttons* to move to it, then press the  button.



When you have selected all the desired settings, start the film (generally by selecting the menu point 'Play film').

During playback

Opening the disc menu



The disc menu can be opened at any time during playback by briefly pressing the blue  button. By this means you can call up all the Disc Menu functions even when the disc is playing.

Track select



You can switch to the next or the previous track on the disc using the  button on the front panel or the  /  buttons on the remote control handset.

A track can also be selected directly by entering its track number using the numeric keypad on the remote control handset.



Pause

Pressing the  () button halts playback temporarily. Pressing the  button resumes playback.

Single-frame playback (DVD only)



When you are playing a DVD, repeated pressing of the  button produces single-frame playback. To resume normal playback press the  button, as previously.

Slow motion (DVD only)

The slow motion function is started by holding the  button pressed in until the function starts. Repeated long presses of the  button alter the speed of the slow motion: $\frac{1}{2}$, $\frac{1}{4}$, $\frac{1}{8}$ speed.

Press the  button to revert to normal playback.

Search

Pressing the  /  buttons starts a search in the reverse or forward directions.

Pressing these buttons repeatedly varies the search rate. The search is concluded by pressing the  button.

CD-Text

If the CD being played contains text information (CD-Text), this is displayed on the television screen connected to the **K1 AV**.

Special functions

Switching the display

A brief press on the  button toggles the integral screen of the **K1 AV** between Track and Playing time.

Repeat function

The  button cycles through the repeat functions of the **K1 AV**. Press the button repeatedly if required until the repeat mode you wish to use appears on the screen.

The following repeat modes are available, according to disc format:

Display	Function	Disc format
RPT CH	Repeat chapter	DVD
RPT TT	Repeat track	DVD
RPT ONE	Repeat track	CD, MP3
RPT FLD	Repeat folder	MP3
SINGLE	Play track (once)	MP3
RPT ALL	Repeat whole disc	DVD, CD, (S)VCD
OFF	Normal playback - no repeat	

Sub-title language (DVD only)

You can select the sub-title language, or switch sub-titles on and off, during playback by pressing the  button.

Sound track (DVD only)

During playback you can select the sound tracks present on the disc by pressing the  button.

Camera angle (DVD only)

If several camera angles are available for a particular sequence on a DVD, this is indicated by a camera symbol on the screen.

You can switch between the various camera angles by holding the  button pressed in, repeatedly if necessary. The angles can also be selected directly using the numeric buttons.

Manual CURSOR control

With the **K1 AV** the following control buttons (**CURSOR** buttons) on the remote control handset

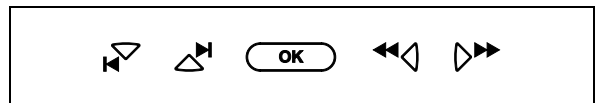

are used both for controlling the disc mechanism functions (skip back, skip forward, search) and also for navigating within menus. the **K1 AV** detects automatically whether you are currently operating the disc mechanism or finding your way round a menu.

However, a few DVDs - especially older ones - do not deliver this information to the player, and therefore give no indication of whether a menu is open or not. With these discs the screen message '*DISC MENU*' does not appear when the menu is opened, and in such cases you will not be able to move around within the menu in the normal way. For such eventualities the **K1 AV** can be switched manually to the '*Cursor navigation*' mode.

Switching to CURSOR control

Hold the  button pressed in until the screen displays the message '*CURSOR*'. You will now be able to operate all problematic menus.

Switch CURSOR control off

To revert to normal operation (disc mechanism control) hold the  button pressed in again until the '*CURSOR*' message disappears from the screen.



In Cursor mode the buttons of the control button pad only carry out menu control functions.



When you need to operate the disc mechanism in the normal way, you must close Cursor control mode again.

Playing MP3 / JPEG / Picture CDs



The **K1 AV** is able to play MP3 music discs, JPEG discs and Picture Discs. These discs are controlled using on-screen menus, so please switch on your TV set and select the picture input to which the **K1 AV** is connected.

JPEG / PICTURE CD

After you insert a JPEG / Picture CD the monitor displays the menu structure of the disc.

You can select a folder or directory using the  buttons, and open it by pressing the  button. Select the picture you wish to view using the  buttons.



As soon as a picture is selected (marked yellow), it is superimposed on the menu as a preview.

Press the  button to confirm your choice, and start a slide show in full-screen mode; this continues to the end of the folder or directory. You can interrupt playback at any time by pressing the  button, and stop it completely with the  button.

Some menus contain a large number of entries, and you can shorten the time it takes to move around such menus by holding the  button pressed in; this causes the system to skip forward by four folders or tracks at a time.



You can also enter the desired album / track number directly using the numeric buttons on the remote control handset.



Functions during playback

- Pressing the  buttons mirrors the displayed picture around the vertical or horizontal axis.
- Pressing the  buttons rotates the picture to the right or left.
- A long press on the  button displays the next picture.

MP3 CD

After you insert an MP3 CD the monitor displays the menu structure of the disc.





You can select an album directory using the  buttons, and open it by pressing the  button. Select the track you wish to listen to using the  buttons.

Press the  button to confirm your choice, then playback of the selected track commences, and continues to the end of the directory. You can interrupt playback at any time by pressing the  button, and stop it completely with the  button.

Some menus contain a large number of entries, and you can shorten the time it takes to move around such menus by holding the  button pressed in; this causes the system to skip forward by four folders or tracks at a time.

You can also enter the desired album / track number directly using the numeric buttons on the remote control handset.

Functions during playback:

- Pressing the  buttons selects a track (marked yellow) from which playback is to resume after you press the  button. The currently stored track is marked in white.
- A long press on the  button resumes playback at the next track.
- Pressing the  buttons starts the fast forward / rewind process. You can press the  button at any time to revert to normal playback mode.

Compatible formats

The **K1 AV** is able to play the following formats:

Audio formats

CD-Audio (CDDA, CD-R, CD-RW)
MP-3 CD (MP3: see the info box below)

Video formats

DVD-Video (DVD, DVD-R, DVD-RW)
VideoCD (VCD, S-VCD)
JPEG Picture CD



Requirements regarding MP3 discs

There are many different MP3 formats. When creating an MP3 disc please keep to the format information stated below. If you decide to use a different format, you may find that the disc does not play, or the sound is distorted and interrupted during playback. A typical MP3 CD contains a very large number of music tracks, so it may take more than ten seconds for the disc player to read the MP3-CD.

If you insert a multi-session disc, please note that the player only supports the first "session".

The following formats are supported:

- CDs to ISO 9660 formats
- max. 30 characters
- max. file levels: 8
- max. ALB number 32
- supports BVR bit-rate
- supported sampling frequencies for MP3-CD: 32 kHz, 44.1 kHz, 48 kHz
- supported bit-rates for MP3-CD: 32, 64, 96, 128, 192, 256, 320 (kbps)

The following formats are **not** supported:

- files such as *.WMA, *.AAC, *.DLF, *.M3U, *.PLS
- file names including Chinese characters
- discs in which the recording session was not completed (non session closed)
- discs recorded using the UDF format
- files which contain ID3V2 tags

Compatibility with recordable media

The **K1** can play recordable (CD-R, DVD-R) and rewritable (CD-RW, DVD-RW) discs (see Specification), provided that they are in accordance with the general standard for CD-Audio and DVD-Video discs.



There are now so many different types of blank discs, disc recorders (burners) and burning software that it is not possible to guarantee general compatibility.

If you encounter a compatibility problem, we recommend that you try using different blank discs, a different burner or different burning software.

Basic disc player settings (SETUP)

Player Setup Menu

The disc player in the **K1 AV** must be set up to match the characteristics of your TV set and your preferred methods of use. The settings required for this are grouped together in a 'Player Setup Menu', which is displayed on your television screen. In most cases you will only need to adjust the settings contained in the Player Setup Menu once, i.e. when the machine is initially set up and installed. You may need to refer to the operating instructions supplied with your TV set in order to establish the correct setup values, so please have the manual to hand before you start this process.

The Player Setup Menu is divided into the following sub-menus:

- GENERAL SETUP MENU

This is where you set general device settings such as screen size, display brightness etc.

- AUDIO SETUP MENU

In this sub-menu you set the audio characteristics, such as the sound mode and format of the digital output.

- VIDEO MENU

At this point you can set the picture settings of the **K1 AV** such as the screen format (normal 4:3 / wide-screen 16:9), video norm and colour / contrast.

- PREFERRED SETTINGS (stopped disc only)

Here you can set your favoured personal settings, such as the preferred language for sound reproduction and sub-menus, child-protection measures etc.



The "Preferred Settings" sub-menu can only be called up while the disc is stopped.

An overview of the Player Setup Menu is shown in the menu summary on the next page. The adjustment facilities of the individual menus are explained in detail in the following sections.

Operating the SETUP menu

Ensure that the disc player is selected as the listening source, that your TV set is switched on, and that it is switched to the **K1 AV**'s picture input (AV input).

The Player Setup Menu is opened with a long press on the blue **SRC** button on the remote control handset; please hold this button pressed in until the Player Setup Menu appears on your screen. The integral screen on the **K1 AV** shows **SETUP** while the menu is open.

You can now navigate within this menu using the *cursor buttons*, and enter the appropriate settings. When you have made a particular selection, press the **OK** button to confirm your choice; the setting is then accepted and stored.

When you open the menu you will initially be at the top line of the screen menu. At this point you can select the sub-menu you wish to use (GENERAL / AUDIO / VIDEO / PREFERRED SETTINGS) using the / buttons.

Press the button to open the appropriate sub-menu. You can now find your way to a particular menu point using the / buttons.

If you wish to change the setting of any particular menu point, press the button and select the desired setting using the / buttons. Press the **OK** button to confirm your selection, and the setting is then accepted.

In each case pressing the button takes you back to the next higher menu level.

Closing the SETUP menu

To leave the SETUP menu press the button - repeatedly if required - until you return to the topmost line of the menu. Now select the 'End SETUP menu' option, and confirm by pressing the **OK** button.

Player Setup Menu

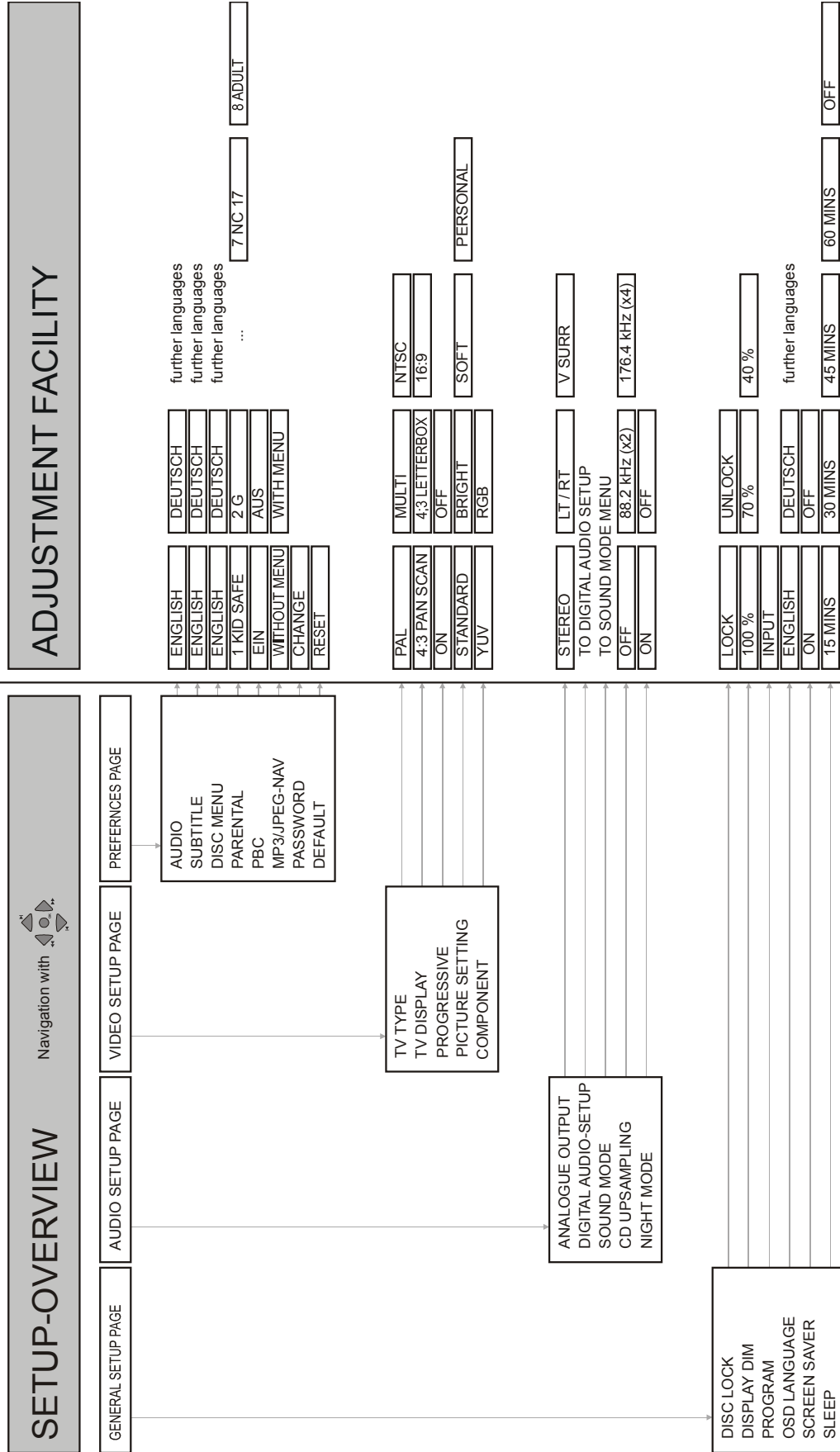

General Setup Menu

Adjustment facility

- DISC LOCK
- DISPLAY DIM
- PROGRAM
- OSD LANGUAGE
- SCREEN SAVER
- SLEEP

LOCK	UNLOCK	
100 %	70 %	40 %
INPUT		
ENGLISH	DEUTSCH	further languages
ON	OFF	
15 MINS	30 MINS	45 MINS 60 MINS OFF

DISC LOCK

Not all discs are categorised or coded by the manufacturer regarding their suitability for young persons. You can prevent playback of specific DVDs by blocking them, or alternatively release the DVD for viewing, disregarding its category.

If you block a disc, you will be asked to enter your password (PIN) before playback. Without the password the machine will not play the disc.



To set a password see the Chapter 'Preferred settings / Password'.

DISPLAY DIM

At this menu point you determine the brightness of the screen which is to apply when DVDs and (S)VCDs are played.



The brightness of the integral **K1 AV** screen can be adjusted for DVD / (S)VCD playback, independently of the normal screen brightness, so that you are not distracted from the film in a darkened room. The brightness level you set in this menu point is activated every time you play a DVD or SVCD. When you are playing other media and sources, the standard screen brightness setting is maintained; this is variable in the menu 'Amplifier Setup menu / Screen brightness'.

PROGRAMS

You can play the contents of the disc in your own desired sequence by programming the order of the tracks to be played.

In this menu point you can create your own playback program for the disc in the drawer.

You can program the desired tracks in the desired sequence under the point '**INPUT**'; up to twenty tracks can be stored.

OSD LANGUAGE

In this menu point you can set the language to be used for the disc player's Player Setup Menu.

SCREEN SAVER

The screen saver helps to prevent damage to your television screen. If the screen saver is switched on, the TV screen will be switched off after a while if playback has been stopped or paused.

SLEEP

The Sleep function automatically switches the **K1 AV** off after a preset time. In the 'OFF' setting the Sleep function is disabled.

Audio-Setup Menu

Adjustment facility

ANALOGUE OUTPUT
DIGITAL AUDIO-SETUP
SOUND MODE
CD UPSAMPLING
NIGHT MODE

STEREO	LT / RT	V SURR
TO DIGITAL AUDIO SETUP TO SOUND MODE MENU		
OFF	88.2 kHz (x2)	176.4 kHz (x4)
ON	OFF	

ANALOGUE OUTPUT

With this option you can determine the sound output format of the **K1 AV** when a disc is being played.

Stereo

If you select this option, Dolby Digital and dts multi-channel sound tracks are converted into STEREO signals (Downmix), so that they can be reproduced through two loudspeakers. Select this setting if you do not have a *Centre* loudspeaker connected to your **K1 AV**.

L/R (LT/RT)

If you select this option, multi-channel information from Dolby and dts sound tracks is processed for three-channel reproduction using a *Centre* loudspeaker. Select this setting if a *Centre* loudspeaker is connected to your **K1 AV**.

V Surr (Virtual Surround)

If you select this option, the signal from 5.1 sources is processed to generate a 'virtual' surround signal which provides an artificial impression of spatial sound in your living room.

This setting can be used both with two-channel reproduction (STEREO) and with reproduction using three loudspeaker channels (3CH MOVIE).

Note



The setup facilities L/R (LT/RT) and V Surr (Virtual Surround) are only available if the 'OFF' setting is selected for CD upsampling (see next column).

CD UPSAMPLING

In this menu point you can adjust the sampling rate which is used when CD signals are upsampled before being converted into analogue signals.

We recommend the '88.2 kHz' setting.



If you wish to use multi-channel (Lt / Rt) or Virtual Surround, the CD upsampling rate must be set to 'OFF'.

If you do not wish to use these modes of operation, you can also select 88.2 or 176.4 kHz at this point; we recommend the '88.2 kHz' setting.

NIGHT MODE

When night mode is switched on, sound is reproduced with a reduced dynamic range.

The result is that loud passages are reproduced more quietly. The 'night mode' is particularly useful when you wish to avoid disturbing neighbours or other people in your house with loud sound special effects in films.

DIGITAL AUDIO-SETUP

DIGITAL OUTPUT

The digital output of the **K1 AV** can be used for connecting external surround decoders or digital recording equipment. Set the data format of the digital output to suit the requirements of the devices to be connected to the unit.

ALL

Select this setting if you have connected an external surround decoder to the 'Digital Audio Out' output.

ONLY PCM

Select this setting if the connected device is not capable of decoding multi-channel audio. It should be used, for example, with digital stereo audio recorders (DAT, CD recorder, MD recorder).

LPCM output

At this point you can activate the 96 kHz setting for the digital output.

If you activate the 96 kHz output, audio signals from DVDs featuring a 96 kHz sound track are reproduced in their native 96 kHz format. Please note that the decoder or recorder connected to the **K1 AV** must also be designed for 96 kHz operation, and must also be set to that value (see the operating instructions supplied with the decoder / recorder).



Caution:

If your decoder does not support the 96 kHz data rate, it is essential to set the 48 kHz setting in this menu point, as your decoder is not capable of reproducing the audio data correctly. If you use the system with the wrong settings, under unfavourable circumstances your loudspeakers could be damaged.

SOUND MODE

Adjustment facility

SOUND MODE

3 D
 MOVIE MODE
 MUSIC MODE

OFF	LIVING R			
OFF				
OFF				

The **K1 AV** features a room sound processor which can create an artificial room sound atmosphere when playing DVDs (film mode) and CDs (music mode). For film and music reproduction various sound programs are available which you can select at this menu point.

Video Setup

Adjustment facility

TV TYPE
TV DISPLAY
PROGRESSIVE
PICTURE SETTING
COMPONENT

PAL	MULTI	NTSC
4:3 PAN SCAN	4:3 LETTERBOX	16:9
ON	OFF	
STANDARD	BRIGHT	SOFT
YUV	RGB	PERSONAL

TV TYPE

This menu contains the options for selecting the TV norm, which must be set to match your monitor or television screen.

PAL

Select this setting if the picture output is to be reproduced on a *PAL* TV set. At this setting, DVDs in *NTSC* format will be converted to the *PAL* format by the **K1 AV**.

Multi

At this setting the **K1 AV** carries out no format conversion. The output from *PAL* DVDs is reproduced as *PAL*, *NTSC* DVDs as *NTSC*.

This setting should only be selected if your television set is a multi-norm type, i.e. one which automatically switches between *PAL* and *NTSC* modes.

NTSC

Select this setting if the picture output is to be reproduced on an *NTSC* television. At this setting, DVDs in *PAL* format will be converted to the *NTSC* format by the **K1 AV**.

TV DISPLAY

In this menu you set the picture output of the **K1 AV** to match the geometry of your TV set.

Note:

The format which you select must be available on the disc. If this is not the case, the selected picture format settings will have no effect on the picture during playback.

4:3 Pan Scan

This produces a picture of full screen height; if a wide-screen film is played, the centre of the picture fills the screen of a 4:3 TV set. Less important areas of the picture are cropped.



Pan Scan is only supported by a few DVDs

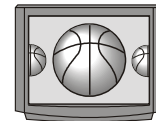

4:3 Letterbox

This option produces a "wide-screen" reproduction with black bars at the top and bottom of the picture. In this setting the entire picture content of the DVD is reproduced.

We recommend this setting for use with 4:3 televisions.



16:9 (wide-screen)

For reproduction on a wide-screen television (16 : 9 format).

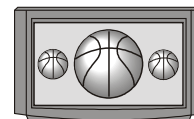

PROGRESSIVE

The 'Progressive' menu point can only be altered if you have set the Component output to 'YUV' (see menu point 'Component').

In progressive scan mode the machine generates full-frame images from the 'half-frames' stored on the DVD; this reduces picture flicker, and therefore gives improved picture reproduction with monitors and TV screens which are capable of reproducing progressive images. Progressive pictures are generated in the form of a YUV component signal, so the **K1 AV** must be connected to the YUV input of your monitor or screen in order to be able to use progressive scan.



Important note:

Before you activate progressive scan, please ensure that your video monitor or television set supports this mode of operation (read the operating instructions if you are not sure)!

If the monitor is not designed for progressive scan, the result will be picture interference, or even no picture at all. If a problem arises, please switch back to normal operation **immediately**.

Off

Disables the progressive scan function.

On

Activates the progressive scan function.

PICTURE SETTING

In the Picture Setting menu you can adjust the picture reproduction to suit your personal preference.

You can either select one of the pre-defined picture settings, or move to the menu point 'Personal' and set your preferred settings for brightness, contrast etc.

COMPONENT

This menu point enables you to toggle the output of the video signal between RGB and YPbPr (YUV).



- If the device is set to YUV, you may find that particular televisions are not synchronised correctly with the DVD player via the Scart connection.
- If you own a TV screen featuring a YUV input with Cinch sockets, you will need a suitable adaptor (SCART → YUV); they are readily available from specialist dealers.
- Many devices do not feature a YUV-capable SCART input, but have three separate Cinch sockets for Y, U and V. In this case please a suitable SCART / YUV adaptor, available from electrical accessory shops.

Basic settings

Adjustment facility

AUDIO
SUBTITLE
DISC MENU
PARENTAL
PBC
MP3/JPEG-NAV
PASSWORD
DEFAULT

ENGLISH	DEUTSCH
ENGLISH	DEUTSCH
ENGLISH	DEUTSCH
1 KID SAFE	2 G
EIN	AUS
WITHOUT MENU	WITH MENU
CHANGE	
RESET	

further languages
further languages
further languages

...

7 NC 17

8 ADULT

AUDIO SUBTITLE DISC MENU

You can select your preferred menu and synchronous language in the sub-menus Audio, Sub-titles and Disc Menu. If the selected language is not available on a particular disc, the basic disc language will be used instead.

PARENTAL

Some DVDs may have a child-protection feature which applies to the whole disc or just specific scenes on the disc. This function enables you to set your own restriction level. The categorisation takes the form of levels 1 to 8, and is country-specific. In this way you can prevent the playback of particular discs which you consider unsuitable for your children, or - where alternative scenes are available on the disc - force the DVD to play these alternatives.

Home-recorded VCD, SVCD and CD discs do not feature this categorisation, and the same applies to most illegal DVD discs.



Some DVDs do not feature categorisation, even though the film category is printed on the disc sleeve. In this case the child protection feature will not work.

PBC

The playback control function (VCD 2.0 only) can be set to 'On' or 'Off'. If you select 'On', the disc menu (if available on the disc) is displayed on the television.

MP3 / JPEG NAV

If you select the 'with menu' option, an on-screen menu is provided for you to find your way around an MP3 / JPEG disc.

PASSWORD

At this menu point you can change the six-digit password. The default password is as follows:

136 900

Use the numerical keypad to enter the 6-digit code, then enter your new code, and confirm it by entering it a second time.

The new password is now valid. Please remember the new password carefully, as you will need to enter it for all access functions from now on.



If you have forgotten your old password, enter '136900'.

DEFAULT

If you select the 'Reset' menu point (reset of basic settings), all settings will be reset to the factory default settings with the exception of your child-protection password.





Basic settings
Installation
Using the K1 AV for the first time
Safety notes
Trouble-shooting
Glossary
Specification

This chapter describes all those aspects which are of fundamental importance when setting up and initially using the **K1 AV**, but which are not relevant for the daily handling of the system. This section should be read before the machine is used, as the instructions and information are very important and must be observed.

Amplifier Setup Menu (Basic settings menu)

The Amplifier Setup Menu is where you define the basic settings of the **K1 AV**. When using your **K1 AV** for the first time, please ensure that the menu points relating to your loudspeaker configuration and intended use are set correctly.

The Amplifier Setup Menu is opened with a **long** press on the yellow  button.

The individual menu points can be called up using the  /  buttons on the remote control handset, and changed using the  /  buttons.

An overview of the Amplifier Setup Menu and its adjustment facilities is shown in the diagram on the next page. The individual menu points and their adjustment facilities are described in detail in the following section.

Amplifier Setup Menu

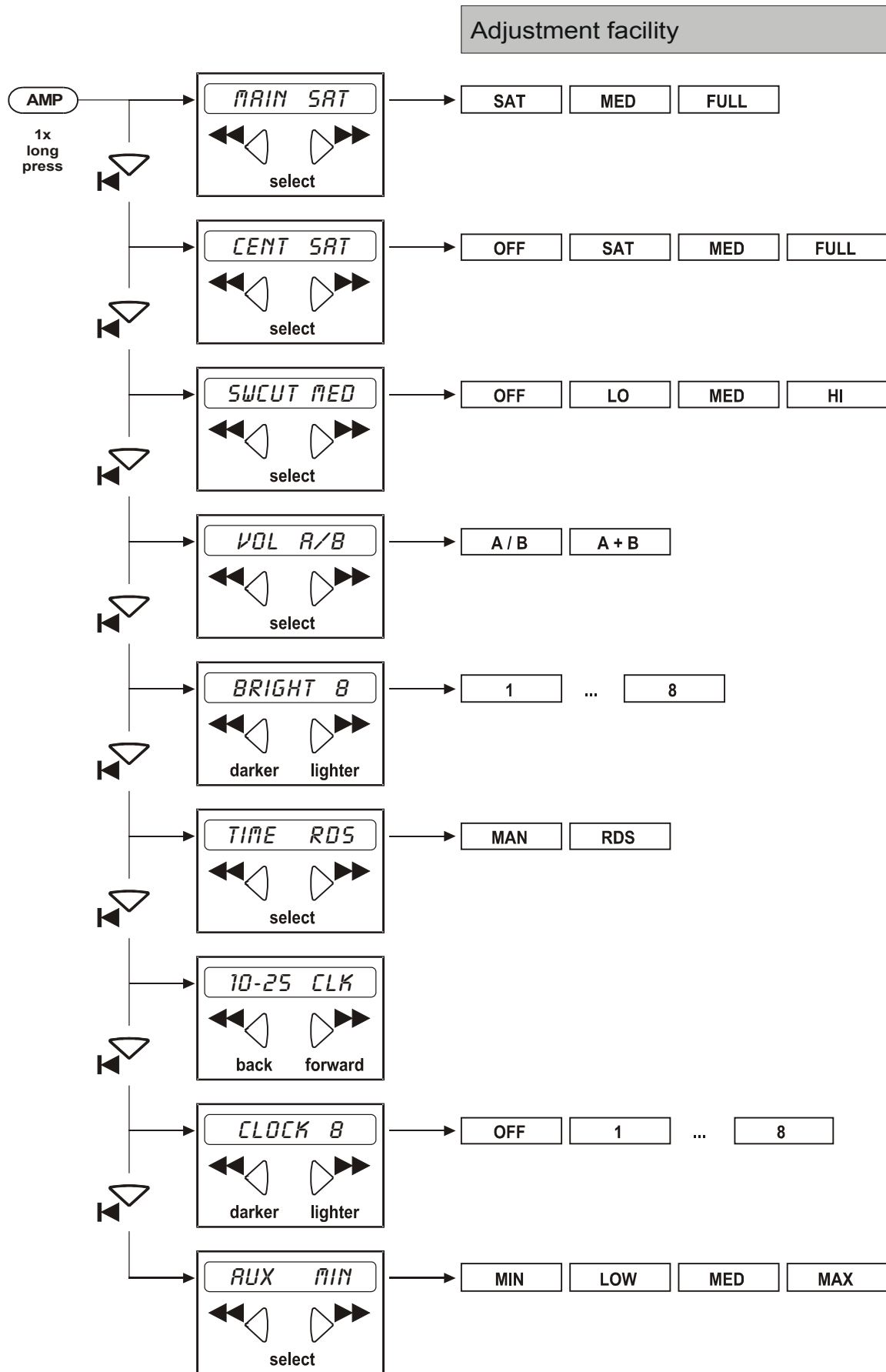

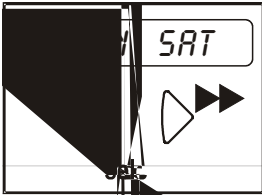

Amplifier Setup Menu point **Main loudspeakers (Main)**

Explanation:

Setting the size and bass range of the main loudspeakers at front left and right.

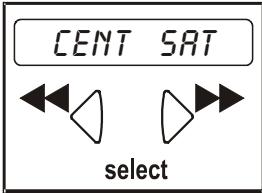

Amplifier Setup Menu point **Centre loudspeaker**

Explanation:

Setting the size and bass range of the Centre loudspeaker.

If no Centre speaker is connected, please select the setting '**OFF**'.

Operation:

OFF This setting **must** be selected if **no Centre loudspeaker** is connected, otherwise all centrally localised components of the sound event will be lost.

SAT Intended for very small speakers (satellites) with limited bass response. The low-frequency bass signals (below 100 Hz) of the main channels are passed to the sub-woofer. A sub-woofer should always be present when SAT speakers are used, otherwise there will be inadequate bass response and the sound will be unbalanced.

MED Intended for medium-sized loudspeakers (compact speakers, bookshelf speakers) The low-frequency bass signals below 60 Hz are passed to the sub-woofer. A sub-woofer is not absolutely essential when compact speakers are used, but it can provide useful support to the low bass response, and make a distinct improvement to the overall sound image.

FULL for larger speakers. The entire frequency range is reproduced by the main channels without restriction. No sub-woofer is required for full-range loudspeakers, but under certain circumstances a large, powerful sub-woofer can still make a contribution, as it reduces the workload of the primary speakers where passages contain extremely low frequencies or very loud sound.

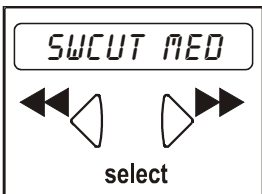

Amplifier Setup Menu point **Sub-woofer cut-off frequency (SWCUT)**

Explanation:

In this menu the sub-woofer cut-off frequency can be set to match the main loudspeakers in use.

For small SAT loudspeakers the setting '**HIGH**' (corresponding to 100 Hz) should be selected.

With bookshelf loudspeakers the '**MEDIUM**' setting (corresponding to 60 Hz) is generally most effective.

If a large sub-woofer is employed to support the deep bass with large main loudspeakers, we recommend the '**LOW**' setting (corresponding to 40 Hz).

If no sub-woofer is present in the system, please select the setting '**OFF**'.

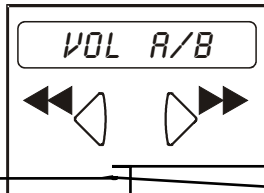

Amplifier Setup Menu point **Volume setting, separate**

Explanation:

Normally the volume for the loudspeaker outputs **A** and **B** is controlled in parallel. However, if you connect the E2000 external remote control receiver, and if a pair of loudspeakers is connected to loudspeaker terminals **B** (preferably in an adjacent room), this menu point can be used to set up separate volume control for the loudspeaker pairs **A** and **B**.

If the multi-room option is selected, only the speakers in the operator's room will be activated when you switch on the **K1 AV**; the other pair of speakers remains muted.

The volume for **A** can only be adjusted using the **VOLUME** buttons on the machine, or via the integral remote control receiver.

The volume for **B** can only be adjusted using the external remote control receiver (see also the chapter '**Multi-room mode**').

Operation:

The screen shows the current status of the system:

'VOL A/B' **separate** volume control for multi-room use.

or

'VOL A+B' **parallel** volume control for single-room use.

Select your preferred option using the buttons **←** or **→**. The menu closes when you press the **AMP** button.

If the menu control buttons (**AMP**, **↖**, **↗**, **←**, **→** or **OK**) are not operated for a period of about ten seconds, the amplifier interrupts the menu (Timeout) and reverts to the normal screen display.

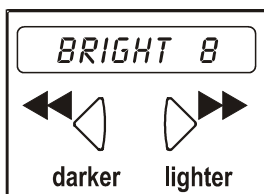

Amplifier Setup Menu point **Screen brightness**

Explanation:

The brightness of the integral screen can be adjusted (dimmed) through eight stages (1 to 8).

'DIMMER 1' (= darkest stage)
to
'DIMMER 8' (= brightest stage)

This facility enables you to set the screen brightness to suit the lighting conditions in the machine's location in your listening room.

Operation:

The screen displays the current brightness stage (e.g.: 3): **'DIMMER 3'**

You can change the current setting by briefly pressing the remote control buttons ◀◀ or ▶▶.

Every change takes effect immediately. The menu is closed when you press the **AMP** button.

If the menu control buttons (**AMP**, ⏪, ⏩, ◀◀, ▶▶ or **OK**) are not operated for a period of about ten seconds, the amplifier interrupts the menu (Timeout) and reverts to the normal screen display.



You can also set a brightness value which is always used if discs containing pictures are played; this setting is independent of the brightness value you select in this menu. The setting for pictures is selected in the menu for the 'DISC' source (see chapter '**Player Setup Menu / General Setup Menu**'). For example, this makes it possible to operate the screen at its darkest setting when playing DVDs, but at a very bright setting when you are listening to the radio.

The brightness setting for the time display can also be adjusted (see chapter '**Amplifier Setup Menu / Clock display brightness**').

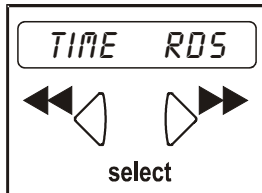

Amplifier Setup Menu point **Time** (set automatically by RDS)

Explanation:

In this menu point you can determine the method of setting the internal clock.

Operation:

The screen shows the current setting.

MAN The time can be set manually in the menu point '**Set clock**'.

RDS The time is read automatically from the RDS signal of the received radio station; the machine accepts this time setting. This only works if good RDS reception is available.



If you select the latter option, you **cannot** change the time of day **manually**.



The manual setting option should always be selected if you live in an area where no stations with RDS (Radio Data System) can be picked up.



Amplifier Setup Menu point **Set clock (CLK)**

Explanation:

The **K1 AV**'s internal clock makes it possible to switch the machine on automatically at a pre-programmed time. If this is to work properly, the clock must first be set to the correct time of day.



Operation:

The screen displays the currently set time, e.g.: **'10-25 CLK'**.

As soon as you alter this time using the ◀▶ or ▶▶ buttons, the word **'CLK'** starts to flash.

The time of day changes at three different rates as long as the buttons are held pressed in.

You have to press the **OK** button in order to accept the time you have set. For about one second the screen then displays the new time of day and the word **'SET'**, e.g. **'15-30 SET'**.

If the menu control buttons (**AMP**), , , ◀▶, ▶▶ or **OK** are not operated for a period of about ten seconds - or, after setting the clock, for 90 seconds - the amplifier interrupts the menu (Timeout) and reverts to the normal screen display.



Manual time adjustment is only possible if you have selected 'MAN' in the menu point '**Time**'.

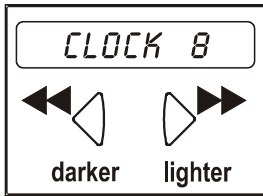

Amplifier Setup Menu point **Brightness of the time display (CLOCK)**

Explanation:

The brightness of the clock display can be adjusted (dimmed) through eight stages (1 to 8).

'DIMMER 1' (= darkest stage)
to
'DIMMER 8' (= brightest stage)

This facility enables you to set the screen brightness to suit the lighting conditions in the machine's particular location in your listening room.

Operation:

The screen displays the current brightness stage (e.g.: 3):

'DIMMER 3'

You can change the current setting by briefly pressing the remote control buttons ◀◀ or ▶▶.



The brightness value selected here is only used when the clock is displayed.

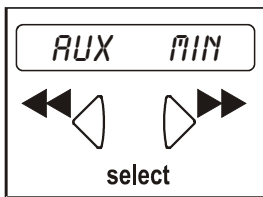

Amplifier Setup Menu point **AUX input sensitivity**

Explanation:

Auxiliary equipment connected to the **AUX** input may generate an output at a different level. This will produce a disturbing volume difference when you switch source devices. the sensitivity of the **AUX** input can be adjusted in four stages to overcome the problem of quiet auxiliary equipment:

'AUX MIN'
'AUX LOW'
'AUX MED'
'AUX MAX'

The volume control responds analogously, i.e. at '**MIN**' it is quietest, and at '**MAX**' it is loudest.



To avoid overload distortion, the **AUX** input should always be set to the lowest sensitivity ('**MIN**') when you first connect a high-level device to the machine.

Operation:

The screen shows the current setting, e.g.: '**AUX MIN**'

The current setting can be changed using the ◀◀ or ▶▶ buttons on the remote control handset; every change takes effect immediately. The menu closes when you press the **AMP** button.

If the menu control buttons (**AMP**, ↵, ▲, ◀◀, ▶▶ or **OK**) are not operated for a period of about ten seconds, the amplifier interrupts the menu (Timeout) and reverts to the normal screen display.

Sockets

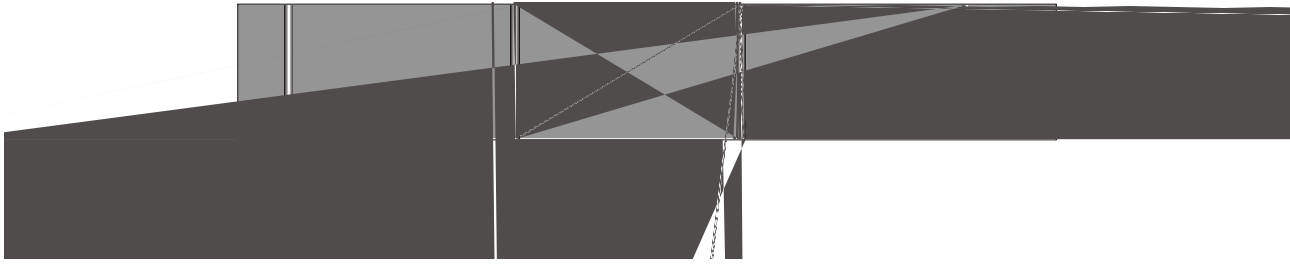

① ANT

Aerial input

The **K1 AV** features a 75 Ω aerial input **ANT**, which is suitable both for a normal domestic aerial and for a cable connection.

'Trailing wire' aerials generally produce very limited, poor-quality reception, and should be used at best as a temporary solution.

② AUX

Universal analogue stereo sound input with variable sensitivity.

③ TAPE/VCR

Input / output sockets for connecting a device with recording and playback facilities (recorder).

If a recording machine is connected, the **INPUT** sockets of the recorder must be connected to the **OUT** sockets of the **K1 AV**, and the **OUTPUT** sockets of the recorder to the **IN** sockets of the **K1 AV**.

④ SUBW

Output sockets for an **active sub-woofer**.

The sub-woofer is optional.



If you connect a sub-woofer, please select the appropriate settings in the amplifier menu ('**SWLEV**') and in the amplifier setup menu ('**SWCUT**').



If a sub-woofer is **not** present in the system, it is essential to disable the sub-woofer in the amplifier setup menu (setting '**SW OFF**').

If the sub-woofer is not disabled in the amplifier **SETUP** menu, the low-frequency sound components will be absent from the overall sound for as long as no sub-woofer is connected.

⑤ A

Loudspeaker terminals *)

The main pair of loudspeakers is connected to the **A** loudspeaker output. The impedance of each speaker should be no lower than 4 Ω .

Please set the size of your loudspeakers correctly in the '**Setup Menu**'.



- It is very important to ensure that no short-circuits occur at the speaker terminals as a result of projecting cable strands or stray wires.
- If mini-loudspeakers (usually known as satellites) are used as the main loudspeakers, a sub-woofer should always be used.

⑥ Mains socket

The mains cable supplied with the machine should be plugged into this socket. The **K1 AV** is supplied with mains power through this cable.

⑦ DIGITAL OUT

Digital sound output from the disc player, for connection to external surround decoders or digital recorders.

⑧ CENTER

*Terminals for connecting a Centre loudspeaker * ①*

The Centre loudspeaker is optional.



If you connect a Centre loudspeaker, please select the appropriate settings in the Amplifier Menu ('**C-LEV**') and the Amplifier Setup Menu ('**CENT**').



If there is **no** Centre speaker in your system, it is absolutely essential to disable the Centre loudspeaker in the Amplifier Setup Menu ('**CENT OFF**' setting).

If the Centre is not disabled in the Amplifier Setup Menu, the central sound components will be completely absent from the overall sound as long as no centre speaker is connected.

⑨ **⊖ B**

Loudspeaker terminals * ①

The secondary pair of loudspeakers (remote speakers) should be connected to the **⊖ B** loudspeaker output; these are the speakers in the adjacent room. The impedance of each speaker should be no lower than 4 Ω.



The impedance of each speaker should be no lower than 4 Ω (DIN measurement).

It is very important to ensure that the terminals are tightly screwed down, and that there are no stray cable strands which could produce a short-circuit at the speaker terminals.

Standard insulated 4 mm "banana plugs" can also be fitted in the transverse holes in the speaker terminals. If you do this, please fit the plugs **from the underside!**

The **T+A** accessory range includes a wide range of high-quality cables which are accurately matched to the requirements of **T+A** equipment.

⑩ **TV**

Input / output socket for connecting a television set or screen monitor / projector featuring a SCART connector. For monitors and displays with different sockets please use a suitable adaptor; they are readily available in electrical accessory shops.

This socket can provide picture signals in the form of Composite (FBAS), RGB or optionally YUV Norm. The appropriate setting must be selected in the disc player '**Player Setup Menu**'.

Sound signals are also present at this socket, which means that you can copy material to video recorders by this means.

The Scart socket also carries the sound signals from the connected TV set to the **K1 AV**, so that you can reproduce the television sound via your **K1 AV**.

⑪ **RC IN (E2000)**

Input socket for the **T+A E2000** remote control receiver for the adjacent room (supplied as standard).

⑫ **RLINK**

Control output for connecting **T+A** equipment with the **RLINK** control system.

It is also possible to connect METZ televisions to this socket; the TV set must be prepared for this, and a suitable adaptor (MT Interface) also has to be used. Once set up in this way, these TV sets can also be controlled using the **T+A F6** remote control handset.

Setting up the K1 AV:

Carefully unpack the machine and store the original packaging materials carefully. The carton and packing are specially designed for this unit and will be needed again if you wish to move the equipment at any time.

Please be sure to read the safety notes in these instructions, and observe all the information regarding setting up the machine.

If the unit gets very cold (e.g. when being transported), condensation may form inside it. Please do not switch it on until it has had plenty of time to warm up to room temperature, so that any condensation evaporates completely.

Before placing the unit on a sensitive surface, please check the compatibility of the lacquer and the unit's feet at a non-visible point.

The **K1 AV** should be set up on a rigid, level base. Make sure that the machine is absolutely stable in its installed position.

It should be set up in a dry, well-ventilated site, out of direct sunlight and away from radiators. It must not be located close to heat-generating objects or devices, or anything which is heat-sensitive or highly inflammable.

Make sure that cooling air can flow freely to and from the unit: the cooling slots in the case must not be covered or obstructed.

It is also essential to leave at least 5 cm free space to both sides of the machine and behind it, and at least 15 cm free space above it, to allow the generated heat to escape.

If you set up the machine on a shelf or in a piece of furniture, please note that any doors must not be closed in front of it, as heat will build up in the enclosed space. This will shorten the useful life of the machine, and could be a source of danger.



Any heat build-up will shorten the life of the unit, and could be a source of danger.



If you encounter problems when setting up and using the **K1 AV** for the first time, remember that the cause is often simple, and equally simple to eliminate. Please refer to the chapter of these operating instructions entitled '**Trouble-shooting**'.

Wiring

Notes on connecting the system

- You will find wiring diagrams on the following pages.
- Be sure to connect all your equipment exactly as shown in these diagrams.
- Push all connectors firmly into their sockets. Loose connections can cause hum and other unwanted noises.
- Carry out the required settings for the picture and sound inputs at the surround amplifier or receiver.
- Deploy mains and loudspeaker cables and the **RLINK** cables as far from sound and aerial cables as possible.
- Please use the mains lead supplied to connect the machine to a suitable mains power socket, earthed in the regulation manner.
- To achieve the maximum signal : noise ratio the mains plug should be fitted in the mains socket in such a way that the phase is connected to the socket contact which is marked with a dot (●). The phase of the mains socket can be checked with a suitable device. If you are not sure of this, please ask your specialist dealer.

We recommend the use of the ready-made **T+A** 'POWER LINE' mains cable in conjunction with the 'POWER BAR' mains distribution panel; this panel features a phase indicator as standard.

Once you have completed the wiring of the system, set the volume control to a very low level and switch the system on.

The screen of the **K1 AV** should now light up, and it should be possible to operate the machine.

Place an audio CD in the drawer and press the  button to start playback.

Loudspeaker cables, signal leads

The loudspeaker cables and signal leads (inter-connects) you use to wire your system have an influence on the reproduction quality of the overall system which should not be under-estimated. **T+A** for this reason recommends the use of high-quality cables and connectors.

Our accessory range includes a selection of cables and connectors of excellent quality, whose characteristics are carefully matched to our loudspeakers and electronic components, and harmonise superbly with them.

For difficult or cramped situations the **T+A** accessory range also includes special-length cables fitted with non-standard connectors (e.g. right-angled types), which can be used to solve almost any setup and connection problem.

Mains cables, mains filters

The mains power supply carries the energy required by your equipment, but at the same time it also bears interference from remote equipment, including radios and computer systems.

Our accessory range includes the specially shielded 'POWER FOUR' mains cable, the 'POWER LINE' ready-made mains cable with ferrite ring filters, and the 'POWER LINE' filtered mains distribution panel; all of them designed to keep electro-magnetic interference away from your system. With these accessories it is often possible to improve the reproduction quality of our equipment.

If you have any questions relating to cables, please ask your local **T+A** specialist dealer, where you will find competent, comprehensive and unbiased advice. We would also be glad to send you detailed information on this subject.

Care of the unit:

Always disconnect the unit from the mains supply before cleaning it.

The surfaces of the case should simply be wiped clean with a soft, dry cloth.

Never use abrasive or solvent-based cleaners!

Before switching the unit on again check carefully that there are no short-circuits at the terminals, and that you have not disturbed any connections.



The only permissible method of disposing of this product is to take it to your local collection centre for electrical waste.

F6 Remote Control Handset

Replacing the batteries:

To open the battery compartment cover release the latch by pressing it in and raising the end. Fit new dry batteries of the **LR 03 (MICRO)** type, taking care to position them with correct polarity as shown by the engraved markings. Please remember that **all the cells must be replaced at the same time**.



If you have already switched the remote control to Address 2, you will need to repeat the procedure after changing the batteries (see Chapter '**Changing the remote control address**').



Disposal of exhausted batteries:

Used batteries must not be discarded in the household waste! In accordance with the Battery Disposal Regulation (**BattVO**) they must be returned to the retailer (shop) or to your local toxic waste collection point, where they will be destroyed or recycled safely. All local authorities are now obliged to provide such collection points, and / or vehicles for collecting exhausted batteries.

Switching the remote control address

In rare cases you may find that other remote-controlled equipment in your household uses the same infra-red control codes as the **K1 AV**. This problem manifests itself in the wrong piece of equipment responding to commands, and carrying out unwanted actions. The **K1 AV** can be switched to a different remote control address to eliminate such problems.

K1 AV - setting the remote control address:





Switch the machine on and - while the loudspeaker symbols are still flashing - hold the  button pressed in until a running script appears on the integral screen.



When the running script stops, immediately hold the  button pressed in for about two seconds.

This action switches the machine to the alternative remote control address, and displays the new address '**RC-ADR 1**' or '**RC-ADR 2**' on the screen.

F6 - setting the remote control address:

Now you have to set the address of the **F6** remote control handset to match that of the **K1 AV**:

Hold the  button and the numeric button  pressed in simultaneously. After about ten seconds the LED on the handset will flash. Now press the numeric button  or , as required.

Pressing the numeric button  sets the remote control handset to the standard remote control address (**RC-ADR 1**), while the numeric button  sets the alternative address (**RC-ADR 2**). The LED now goes out to indicate that the change has taken place.



IMPORTANT

The K1 AV and F6 must always be set to the same address!

Wiring diagram

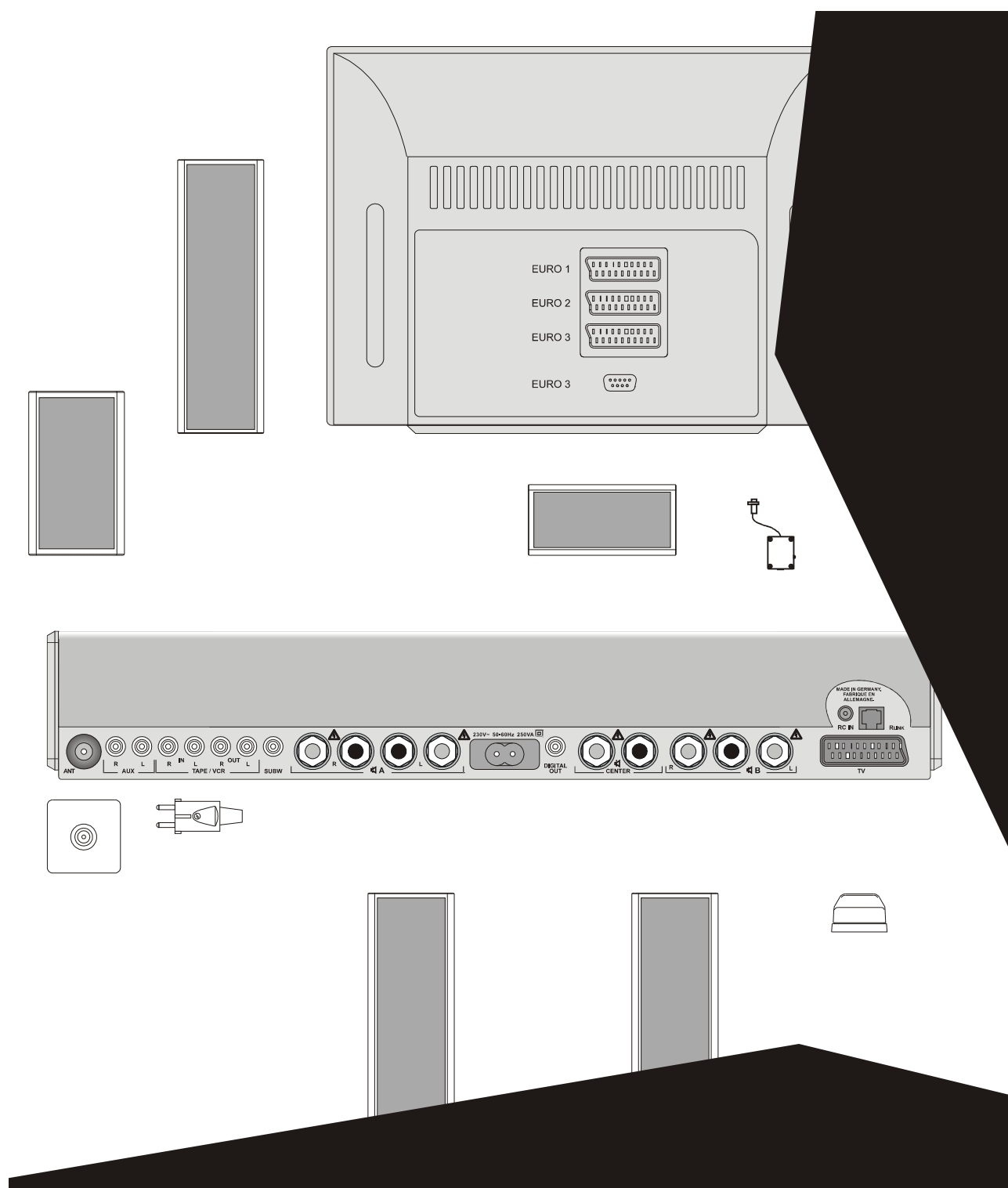

Safety Notes

All the components used in this device satisfy the currently valid German and European safety norms and standards.

Exact quality control of all materials, painstaking production by qualified technical staff, and a fully automatic computer-controlled final checking process ensure consistently high product quality and the maintenance of all specifications.

Please read right through these operating instructions carefully before you attempt to use your new equipment. Note in particular the information regarding setting up and operating the unit, and the safety notes.

The machine must be set up in such a way that it is impossible to touch any of the electrical connections - especially for children. Please read and observe the notes and information in the chapter '*Installation, Using the K1 AV for the first time, Safety notes*'.

The power supply required for this machine is printed on the mains supply socket. The unit must never be connected to a power supply which does not meet this specification. If the **K1 AV** is not to be used for a long period, disconnect it from the mains supply at the wall socket.

Mains cables must be deployed in such a way that there is no danger of them being damaged (e.g. by treading on them or placing furniture on them). Take particular care with connectors, mains distribution panels and the machine's connectors.

Liquid or foreign bodies must never be allowed inside the case. Mains voltage is present inside the unit, and there is a risk of lethal electric shock. Do not exert undue force on the mains connectors.

Protect the machine from water: never place a flower vase or similar vessel containing water on the case.

Do not exert excessive force on the mains connectors.



The On/Off button on the front panel is not a mains isolation switch, and a few of the machine's sub-assemblies remain connected to the mains supply. If you know that the system will not be used for a protracted period, we recommend that you isolate it from the mains power supply by disconnecting the mains plug from the wall socket.

This device should never be used without proper supervision. The **K1 AV** should be set up well out of the reach of small children. This applies to all electrical equipment.



CAUTION ! LETHAL HAZARD !

The unit should only ever be opened by a qualified specialist technician.

Repairs and fuse replacements should be entrusted to an authorised **T+A** specialist workshop.

With the exception of the connections and procedures described in these instructions, no work of any kind may be carried out on the **K1 AV** by unqualified persons.

If the unit is damaged, or if you suspect that it is not functioning correctly, immediately disconnect the mains plug at the wall socket, and ask an authorised **T+A** specialist workshop to check it.

The unit may be damaged by excess voltage in the power supply, the cable network or in aerial systems, as may occur during thunderstorms (lightning strikes) or due to static discharges.

Special power supply units and excess voltage protectors such as the **T+A 'Power Bar'** mains distribution panel offer some degree of protection from damage to equipment due to the hazards described above.

However, if you require absolute security from damage due to excess voltage, the only solution is to disconnect the unit from the mains power supply and any aerial systems.

If you believe there is a danger of excess voltage (e.g. when an electrical storm is building up) disconnect the **K1 AV** from the mains supply and the aerial socket.

All mains power supply and aerial systems to which the unit is connected must meet the currently valid regulations, and must be installed by an approved electrical installer.



Many insurance companies offer lightning damage insurance for electrical equipment as part of their house and contents insurance policies.

Approved usage

This device is designed exclusively for reproducing sound and / or pictures in the domestic environment. It must be operated in a dry indoor room which meets all the recommendations stated in these instructions.

Where the equipment is to be used for other purposes, especially in the medical field or for any purpose where safety is an issue, it is essential to establish the unit's suitability for this application with the manufacturer, and to obtain prior written approval for such usage.

T+A equipment which includes a radio or television receiving section must be operated within the regulations laid down by the Post Office and the Telecommunications authorities in the country in which it is used. This unit may only be used to receive or reproduce those transmissions which are intended for public consumption. The reception or reproduction of other transmissions (e.g. police radio or mobile radio broadcasts) is prohibited.

Device approval and conformity with EU directives

In its original form, this device fulfils the currently valid European norms and German technical regulations. It is approved for use in the EC in accordance with the relevant regulations.

The machine carries the **CE** symbol, which means that **T+A** declares that it conforms with the EU directives **89/336/EWG**, modified by **91/263/EWG** and **93/68/EWG** and **73/23/EWG**, modified by **93/68/EWG** and the national laws derived from these directives.

The original, unmodified factory serial number must be present on the outside of the machine, and must be clearly legible. The serial number is part of our conformity declaration, and therefore of the operational approval for the machine.

Serial numbers on the machine and in the original **T+A** paperwork (especially the quality control and guarantee certificates) must not be removed or modified, and must be identical.

Infringement of these regulations invalidates the conformity approval of **T+A**, and operation of the machine within the EU is then prohibited, and punishable under currently valid EU and national laws.

Any modifications to the machine, or repairs or other interventions carried out on the machine by persons not authorised by **T+A** or other third parties, invalidate the machine's approval and operational permit.

The machine may only be connected to original **T+A** accessories or such auxiliary equipment which is itself approved, and which satisfies all currently valid statutory regulations.

When used in conjunction with auxiliary equipment, or as part of a system, the unit must only be employed for the usage stated in the chapter '**Approved usage**'.

Glossary

Amplifier Setup Menu

In the **Amplifier Setup Menu** the basic settings for the **K1 AV** are defined at the time the system is initially installed. The amplifier setup menu can be opened with a **long** press on the **AMP** button on the remote control handset.

The Amplifier Setup Menu is supplemented by the Amplifier Menu which contains functions which are required more often; these include the Balance and Tone controls. The amplifier menu is opened with a **brief** press on the **AMP** button.

Attenuator = aerial signal reducer

When picking up stations close to an unusually powerful local station you may hear intermodulation effects (whistling and twittering sounds). The aerial attenuator reduces the strength of the signal received by the aerial, and this reduces the unwanted intermodulation effects.

Bass management

The term bass management covers the division of the frequency band into low and fairly high ranges, with the effect that the bass signal is fed to the *sub-woofer* and the higher ranges to the other loudspeakers present in your system.

When small loudspeakers (and especially satellite speakers) are used, a *sub-woofer* should always be included in the system in order to ensure good bass reproduction. The bass management feature ensures that low-frequency sounds below the *cut-off frequency* are diverted to the sub-woofer; if allowed to reach the SAT speakers these signals would overload them.

Cable network

During the development of the **K1 AV** receiver the requirements of the European cable network were considered to be very important. The large overload resistance and excellent selectivity of the tuner provide straightforward operation with cable sources, without loss of quality.

Centre, Centre loudspeaker





The optional loudspeaker at front centre. Ideally the Centre speaker should be set up immediately adjacent to the television screen. For music reproduction, the Centre fills the 'acoustic hole' in the centre between the stereo loudspeakers, and provides improved spatial imaging and localisation of sound events; this is particularly important if the main speakers are spaced widely apart. When a film is being played, the third speaker improves speech localisation and assignment of the acoustic signals relative to the picture.

Composite Video (FBAS)

A video signal in which the brightness and colour take the form of a mixed signal which is passed along a single cable conductor. For this reason FBAS delivers poorer picture quality than the RGB or YUV video norms.

The **K1 AV** generates pictures to the FBAS norm in addition to RGB and YUV. However, you should only choose this method of transmission if your television cannot process RGB or YUV video signals.

CURSOR, cursor buttons

The cursor buttons are the 'control buttons' on your remote control handset ( /  /  /  / ).

These buttons are used to navigate around the disc menus on DVDs, to select files on Photo discs and MP3 discs, and to operate the **K1 AV**'s setup menus.

Cut-off frequency

The frequency below which the sound is passed to the sub-woofer. Higher sounds are passed to the main speakers and the *centre speaker*.

The cut-off frequency of the **K1 AV** can be adjusted, and should be set in the menu 'Basic settings / Using the system for the first time' to suit the size of your loudspeakers.

dB

The unit of measurement for electrical levels is the deciBel (dB).

Disc menu, DVD menu

A DVD may contain a disc menu with selection facilities for individual **tracks** and / or **chapters**. Depending on the DVD, the disc may also contain games, bonus material or alternative camera viewing angles, additional synchronised languages and sub-titles, all of which can be set or called up using the disc menu.



The content, appearance and behaviour of the disc menu are defined and controlled by the disc itself. If you encounter functional problems in conjunction with the disc menu, please contact the manufacturer or supplier of the disc in the first instance.

It is important to draw a distinction between two different menu functions: disc menus and player menus.

- The **disc menu** is stored on the DVD itself. With it you can select and control particular disc functions such as language selection, sub-title selection, background information on the film, games, etc.

The content and exact method of operation of these disc menus differ from one DVD to the next. You can generally operate them using the navigation buttons, but in individual cases you should follow the operating information which is provided on the TV screen.

The disc menu is opened with a brief press on the  button on the remote control handset.

Field strength

Electrical field strength is the measurement of the level (signal strength) of the signal supplied by the aerial to the receiver. The higher the field strength of the tuned station, the better - in general terms - the reception quality.

The field strength is primarily determined by the following factors:

1. Distance to the transmitter
2. Obstacles (mountains etc.) between transmitter and receiver
3. Transmitter power
4. Quality and orientation of the aerial system

Point 4 is of crucial importance to good reception, as reception results will always be inferior with a poor-quality aerial system.

If you wish to plan or optimise your aerial system, your **T+A** specialist dealer will be glad to advise you, taking into account the particular reception conditions in your locality.

FM = Frequency Modulation

Transmitters which use the VHF radio system employ a type of modulation known as '**FM**'. This transmission mode offers excellent sound quality combined with good interference rejection.

Format, disc format

Nowadays there very many different optical storage media (discs) available, designed for and containing widely varying content. We can differentiate between music disc formats such as CD and MP3 discs, video formats such as DVD, VCD, S-VCD and photo discs.

The formats which can be played by the **K1 AV** are listed in the chapter 'Specification'.

Loudspeaker configuration

The **K1 AV** can be operated with various loudspeaker combinations (configurations). The minimal configuration consists of two loudspeakers (main speakers): right and left. An optional *Centre* loudspeaker and a sub-woofer can also be connected.

The **K1 AV** is also capable of driving two further loudspeakers in an adjacent room.

Muting = inter-station hiss suppression

The **K1 AV**'s automatic hiss suppression circuit suppresses the annoying hiss which is picked up between stations and on very weak stations (which are not received at adequate quality) when the tuner is carrying out an automatic station search.

NTSC

American television norm offering 480 picture lines and 60 half-frames per second. The **K1 AV** is capable of generating either PAL or American NTSC video signals.

PAL

European television norm with 625 picture lines and 50 half-frames per second. The **K1 AV** is capable of generating either PAL or American NTSC video signals.

Preset = station memory

The **K1 AV** can store up to sixty radio stations together with all the appropriate reception settings; they can then be called up simply by pressing a button.

RDS = Radio Data System

Many radio stations broadcast supplementary digital information along with their programme material, and the **K1 AV** is fitted with an RDS decoder which picks up this data. When tuned to an RDS station it displays the station name in plain text on its alpha-numeric screen. This is a great advantage when carrying out a station search. The radio text function provides information to accompany various programmes, and this can also be displayed on the **K1 AV**'s integral screen.

RGB Video

A video signal which uses separate cable conductors to transfer the basic colours: red, green and blue. Like YUV Video, RGB delivers the highest-quality video reproduction. RGB is primarily used by European televisions. The picture output of the **K1 AV** can be set to RGB.

If your TV set supports RGB reproduction, you should always select this method of connection. RGB mode simply delivers the best possible picture quality.

R LINK

All the components of a **T+A** system which are fitted with an **R LINK** control socket are able to communicate via this universal control interface.

SCART

A widespread normalised connection using a standard 21-pin connector. SCART connections are capable of transferring all picture norms plus supplementary control signals (e.g. for switching between 3:4 and 16:9 picture formats). If you wish to connect a SCART connector to a different standard connector type (e.g. Cinch or Hosiden), you can use adaptors which are widely available from electrical accessory suppliers.

Search threshold

The station search threshold is the minimal field strength value at which the automatic station search stops. It is set in such a way that very weak stations are skipped.

Source device, listening source

The source devices are those machines in a Hi-Fi system which supply a sound signal: tuner, DVD player, cassette recorder, etc.

The listening source is the machine to which you are currently listening.

The **K1 AV** can be switched to three external listening sources - **TV**, **TAPE** and **AUX** - in addition to the integral listening sources **TUNER** and **DISC**.

Stand-by mode

The **K1 AV** can be switched on from the 'Ready' state from the remote control handset.

Sub-woofer

A special loudspeaker for low sounds. An active sub-woofer (sub-woofer with integral amplifier) can be connected to the **K1 AV**. A sub-woofer is particularly recommended if your main loudspeakers are small in size.

Tape monitor (MONITOR)

This means listening to the signal recorded on a cassette or other tape during the actual recording process. To be able to exploit the **K1 AV's** monitor function the connected recorder must feature a tape monitor function.

Update

The machine's central processor and signal processor run programs which can be updated at any time, making it possible to expand the machine's functions and facilities, and make it capable of meeting new requirements.

Virtual Surround

This is a sound reproduction system which provides an artificial impression of spatial surround sound with only two or three front loudspeakers. With this system the virtual room sound is generated primarily in the area exactly between the main loudspeakers. Please note that the impression of virtual space may be restricted if the listening position is unfavourable, or if the listening room is acoustically difficult.

YUV (Component Video)

A video signal in which the picture brightness (Y) and two colour difference signals (U, V) are passed along separate cable conductors. Like RGB Video, YUV supplies the best possible picture reproduction. YUV is primarily used with projectors, but also by a few flat-screen televisions and American TV sets. The picture output of the **K1 AV** can be set to YUV output.

If your display supports YUV reproduction, select this method of connection on the TV set.

Trouble-shooting

Many problems have a simple cause and a correspondingly simple solution. The following chapter describes a few difficulties you may encounter, and the measures you need to take to cure them.

If you find it impossible to solve a problem with the help of these notes please disconnect the unit from the mains and ask your authorised **T+A** specialist dealer for advice.

Problem:	K1 AV does not switch on (screen and  button do not light up)
Cause:	Mains cable not plugged in correctly.
Remedy:	Check connections, push plugs in firmly.

Problem:	No sound The MONITOR LED on the screen is glowing.
Cause:	The K1 AV is set to MONITOR mode (tape monitor).
Remedy:	Switch off the MONITOR function by pressing the  button on the front panel.

Problem:	No sound
Cause 1:	Loudspeaker output is switched off.
Remedy:	Press the  button on the remote control handset to switch the loudspeaker output on.
Cause 2:	No <i>source device</i> , or incorrect source device selected.
Remedy:	Select the correct source device.
Cause 3:	The volume is set at too low a level.
Remedy:	Increase the volume setting.

Problem:	No sound from the centre loudspeaker
Cause 1:	Centre speaker not activated in the 'Amplifier Setup Menu'.
Remedy:	In the Amplifier Setup Menu switch on the Centre speaker (see chapter ' Amplifier Setup Menu - Centre loudspeaker ').
Cause 2:	The STEREO operating mode is selected.
Remedy:	Press the green  button on the remote control handset to switch to one of the modes 3CH MUSIC or 3CH MOVIE .

Problem:	It is not possible to select the modes 3CH MUSIC and 3CH MOVIE.
Cause:	The centre loudspeaker is not activated in the Amplifier Setup Menu.
Remedy:	Switch on the Centre speaker in the Amplifier Setup Menu (see chapter ' Amplifier Setup Menu - Centre loudspeaker ').

Problem:	Poor sound quality, inadequate bass
Cause:	No <i>sub-woofer</i> connected, but it is not switched off in the 'Amplifier Setup Menu'.
Remedy:	Disable the sub-woofer in the 'Amplifier Setup Menu' (see the chapter ' Amplifier Setup Menu - sub-woofer cut-off frequency ').

Problem:	Poor sound quality, distorted reproduction
Cause:	Very small loudspeakers (especially satellite speakers) are easily overloaded by loud low-frequency sound effects.
Remedy:	It is really essential to use an active sub-woofer in conjunction with SAT speakers. If you are using SAT speakers, select the SAT setting for these loudspeakers and select a high sub-woofer <i>cut-off frequency</i> (HIGH). (see the following points in the chapter ' Amplifier Setup Menu ': <ul style="list-style-type: none"> • Main loudspeakers • Centre loudspeaker • Sub-woofer cut-off frequency)

Problem:	Centre-stage sound events are not reproduced, or are reproduced too quietly.
Cause 1:	No <i>centre speaker</i> connected, but the Centre is not switched off in the 'Amplifier Setup Menu'.
Remedy:	Switch off the Centre in the Amplifier Setup Menu (see chapter ' Amplifier Setup Menu - Centre loudspeaker ').
Cause:2:	A <i>centre speaker</i> is connected to the system, but the Centre is not activated in the Amplifier Setup Menu.
Remedy:	Switch the Centre on in the Amplifier Setup Menu (see chapter ' Amplifier Setup Menu - Centre loudspeaker ').

Problem:	Unwanted whistling sound from the loudspeakers.
Cause:	The aerial is too close to a mains cable or Cinch inter-connect lead.
Remedy:	Re-position the cable an adequate distance away. Use an external aerial or a cable connection.

Problem:	The K1 AV responds correctly when the front panel buttons are operated manually, but does not react to remote control commands.
Cause 1:	Incorrectly inserted batteries or flat batteries in the remote control handset.
Remedy:	Re-install batteries correctly or fit new ones.
Cause 2:	No visual contact between the remote control transmitter and the K1 AV 's remote control receiver.
Remedy:	Ensure direct line-of-sight contact between remote control transmitter and receiver. Note that glass doors may prevent the system working properly. Maximum range between transmitter and receiver is approx. 6 metres. Position the receiver in such a way that it is not subjected to direct sunlight or strong artificial lighting. If you are using a supplementary remote control receiver, this must also be set up in a shaded position. Fluorescent and energy-saving lamps are powerful sources of interference.
Cause 3:	You are using the incorrect version of the optional E2000 remote control receiver. The correct receiver features two visible screw-heads on the underside of the case.
Remedy:	Ask your T+A specialist dealer for advice.
Cause 4:	The batteries in the remote control handset have run flat, and the remote control address has reverted to the default setting.
Remedy:	Change the remote control address of the F6 handset.

Problem:	TUNER, CD player or recorder do not respond to control commands.
Cause:	The machine you wish to operate is not selected as the current listening source.
Remedy:	Press the corresponding source button on the remote control handset, and try again.

Problem:	External devices (Hi-Fi equipment, TV set, video recorder or similar) respond to the signals from the F6 remote control handset; alternatively the K1 AV responds to remote control signals from external devices.
Cause:	Only a limited number of remote control codes are available, so it can occasionally occur that systems respond incorrectly in this way.
Remedy:	The F6 remote control handset and the K1 AV can be set to an alternative remote control address. See the chapter ' Basic settings / Installation / Using the K1 AV for the first time, Switching the remote control address '.

Tuner:

Problem:	The RDS station name does not appear on the integral screen.
Cause 1:	The station is not broadcasting RDS information, or the station is not correctly tuned.
Remedy:	Tune in the station so that the tuning indicator is central.
Cause 2:	Interference is affecting the station, or the field strength is too low.
Remedy:	Select stations which can be picked up without background hiss and interference.

Problem:	After a house move the integral screen still displays the old program names - but the stations can no longer be picked up.
Cause:	Programs with station names and reception frequencies are still stored in the K1 AV , but they can no longer be received in the new locality.
Remedy 1:	Clear the programs which cannot be received individually (see ' <i>Special tuner functions, 'Erasing presets'</i> ').
Remedy 2:	Erase all stored programs: <ul style="list-style-type: none"> • Switch the machine on, then hold the  button pressed in until a running script appears on the screen. • When the running script stops, immediately hold the TUNER button on the remote control handset pressed in for about two seconds. The integral screen now displays the message: 'Pres-CLR' All the stored programs have now been erased.

Problem:	The K1 AV is working normally, but very few stations, or even none at all, can be picked up.
Cause:	The aerial system or aerial cable is defective.
Remedy:	Check that the aerial cable is making good contact in the aerial socket and on the K1 AV itself.
	Check the aerial cable for damage, and ensure that there are no kinks in it. If you are not sure, fit a new aerial cable.

Problem:	When switching presets the RDS station name does not appear correctly, or only appears after a long delay.
Cause:	The name was not correctly received when the preset was stored, or the transmitting station broadcasts the station name as a running script, which is non-standard.
Remedy:	Call up the preset, wait until the station name appears correctly on the screen, then store it manually.

Disc player:

Problem:	The disc is not recognized correctly, or the screen displays the message 'No Disc'.
Cause 1:	Disc not correctly inserted.
Remedy:	Insert disc centrally, printed face up.
Cause 2:	Disc dirty.
Remedy:	Clean the disc and try again.
Cause 3:	Disc damaged in Table of Contents area (TOC).
Remedy:	No remedy: the disc is unusable.
Cause 4:	The machine has cooled down severely (e.g. after being transported), and condensation has formed on the laser pick-up optics.
Remedy:	Leave the unit in a warm, well ventilated place for about an hour to warm up.

Problem:	Disc stops playing or 'skips'.
Cause:	Disc is dirty or damaged.
Remedy:	Clean the disc and try again.

Specification

Amplifier section			
External sound inputs	3	TV (via SCART) TAPE AUX	1 V / 20 k Ω 1 V / 20 k Ω 350mV....1V / 20 k Ω variable
Sound outputs (line-level)	2	TV (via SCART) TAPE	1 V / 150 Ω 1 V / 150 Ω
Headphone output	1	for headphones > 30 Ω	1 V / 150 Ω
Sub-woofer output	1	For active sub-woofer	1 V / 50 Ω
Output stages, room A	3	Left / Right / Centre	3x 60 / 100 Watts (continuous / music power, 4 Ω)
Output stages, room B	2	Left / Right	2x 20 / 30 Watts (continuous / music power, 4 Ω)
Total harmonic distortion			< 0,02 %
Frequency response			2 Hz 150 kHz
Damping factor			> 400
Operating modes, Sound formats		Stereo 3-channel music 3-channel movie Dolby Virtual Surround - DVD only Soundfields - DVD only	Left / Right Left / Right / Centre Left / Right / Centre Via two (L / R) or three (L / C / R) loudspeaker channels
Bass management, Cut-off frequencies		Full-range loudspeakers (large) Full-range loudspeakers (medium) Satellite loudspeakers Sub-woofer	Unlimited 60 Hz 100 Hz 40, 60, 100 Hz

Tuner		
Reception range	FM	87,5 ... 108 MHz
Sensitivity	Mono/Stereo	0,9 μ V / 33 μ V
Overload margin		> 110 dB μ V
Stereo channel separation		> 40 dB
RDS functions		Station name, Radiotext, time

CD/DVD player		
Mechanism		Linear mechanism with dual laser (650 + 785 nm) Sub-chassis construction
Disc formats	Audio	CD, CD-R, CD/RW MP3 Hybrid SACD (CD layer), Dual disc (CD layer)
	Video	DVD video (DVD-R, DVD-RW) VCD, S-VCD
	Foto	JPEG Picture CD
Functions		<ul style="list-style-type: none"> • Playback program, repeat functions • CD text, MP3 ID3 v2 display, play lists • Trick modes (slow-motion, single frame) • Camera angle, zoom • Photo manager, preview, rotate, slide show, music slide show (JPEG + MP3) • Variable picture optimisation (brightness, contrast, colour)
Video output		<ul style="list-style-type: none"> • Composite (FBAS) • RGB, YUV (switchable) • YUV progressive (480p, 576p) • PAL, NTSC, Multinorm • PAL/NTSC and NTSC/PAL format conversion • 4:3, 16:9, letterbox, panscan
Sound formats		LPCM MPEG, Dolby Digital, dts (as downmix)
Frequency response		1 Hz ... 20 kHz
Total harmonic distortion		< 0,004 %
Digital output	SP-DIF	coax 0,5V / 75 Ω LPCM to IEC 958 Dolby Digital (AC3), dts to IEC 1937

Special functions		Clock (RDS radio clock) Alarm timer (wake with radio) Sleep function (for CD + DVD) Control of METZ TV sets (*)
Accessories	Remote control handset Mains cable SCART lead	F6
Optional special T+A accessories	Remote control set for second room Control interface for METZ TV sets High-quality audio and loudspeaker cables	FBS 6 MT Interface

(*) Optional control interface (MT Interface) required.

The METZ television must feature its own control input. A list of METZ TV sets suitable for this method of control is available from your specialist METZ dealer.

We reserve the right to alter specifications.

T+A elektroakustik GmbH & Co. KG

Herford

Deutschland * Germany

Free Manuals Download Website

<http://myh66.com>

<http://usermanuals.us>

<http://www.somanuals.com>

<http://www.4manuals.cc>

<http://www.manual-lib.com>

<http://www.404manual.com>

<http://www.luxmanual.com>

<http://aubethermostatmanual.com>

Golf course search by state

<http://golfingnear.com>

Email search by domain

<http://emailbydomain.com>

Auto manuals search

<http://auto.somanuals.com>

TV manuals search

<http://tv.somanuals.com>