

T+A

Operating instructions

SADV 1245 R

Welcome.

We are delighted that you have decided to purchase a **T+A** product. With your new **SADV 1245 R** you have acquired a top-quality piece of equipment which has been designed and developed with the wishes of the audiophile music lover as absolute top priority.

Our innovative approach to solving problems, solid and carefully thought-out construction, and the highest quality materials ensure that this unit will satisfy your greatest demands and requirements over a period of many years.

Thorough quality checking of all materials, painstaking production by highly qualified staff, and a fully automatic, computer-controlled final quality control process guarantee a product of high quality which meets the specification in full.

In our production system we avoid the use of all environmentally harmful and potentially injurious substances, such as chlorine-based solvents and CFCs.

Moreover we avoid the use of plastics (especially PVC) as a constructional element wherever possible. Instead we rely upon metals and other non-harmful materials which on the one hand are recyclable and on the other offer very good electrical shielding characteristics.

Our insistence on solid all-metal cases eliminates the problem of adverse effects on sound quality caused by external sources of interference. This also ensures that the electro-magnetic radiation (electro-smog) caused by our equipment is effectively shielded, reducing it to an absolute minimum.

Your new **SADV 1245 R** will play back all media that comply with the universal DVD-Video and SACD-Audio standard. This player offers the reproduction with cinema like picture with stereo or multi channel sound at the highest quality level.

All the unique features of DVD video are available, such as selecting the sound channel and sub-title language, and choosing different angles of view (also depending on DVD type). The unit also includes a child security system which allows you to determine which DVDs your children are permitted to view.

Additional to DVD discs you can also play back Video-CDs (VCD, S-VCD), JPEG picture discs, MP3 music CDs and audio CDs (CDDA). The media that can be played back are labelled with one or more of the labels below:



The unit features digital audio outputs for connection to **DOLBY DIGITAL**¹⁾, **DTS DIGITAL OUT**²⁾ and MPEG multi-channel decoders.

A range of high-quality cables and connectors is available as accessories for this unit, as well as specially designed furniture matching the player's design.

Please accept our thanks for your faith in us; we wish you many hours of pleasure with your **SADV 1245 R**.

T+A elektroakustik GmbH & Co KG

☺ All components used in this device satisfy the currently valid German and European safety norms and standards. In the interests of your own safety please read right through these operating instructions, paying particular attention to the safety notes and the instructions for setting up and operating the equipment.

1) Manufactured under licence to Dolby Laboratories. „Dolby“ and the double-D symbol are registered trademarks of Dolby Laboratories. Confidential, unpublished documents. © 1992-1997 Dolby Laboratories. All rights reserved.

2) „DTS“ is a registered trademark of Digital Theater Systems, Inc.

This product complies with the Low Voltage Directive (73/23/EEC), EMV Directives (89/336/EEC, 92/31/EEC) and CE Marking Directive (93/68/EEC).

IMPORTANT! CAUTION!

This product contains a laser diode of higher class than 1. To ensure continued safety, do not remove any covers or attempt to gain access to the inside of the product.
Refer all servicing to qualified personnel.

The following caution label appear on your device:

Rear panel



On the inner protective housing of the DVD mechanism

CAUTION:	VISIBLE AND INVISIBLE LASER RADIATION WHEN OPEN. AVOID EXPOSURE TO BEAM
VORSICHT:	SICHTBARE UND UNSICHTBARE LASERSTRAHLUNG, WENN ABDECKUNG GEÖFFNET NICHT DEM STRAHL AUSSETZEN
ATTENTION:	RAYONNEMENT LASER VISIBLE ET INVISIBLE EN CAS D'OUVERTURE EXPOSITION DANGEREUSE AU FAISCEAU
DANGER:	VISIBLE AND INVISIBLE LASER RADIATION WHEN OPEN. AVOID DIRECT EXPOSURE TO BEAM

Contents

Operating the unit

Front panel controls	6
Remote control of the SADV 1245 R	10
Operating the SADV 1245 R	12
Play back of MP3 / JPEG / Kodak Picture CD	14
Listening to SACD	15
Hints for using the SADV 1245 R in combination with SR 1535 R and DD 1535 R	16

On screen menus

Menu Functions of the SADV 1245 R	18
--	----

Disc menu

DVD / VCD special functions	19
• Menu function	19
• Calling up and operating the DISC menu	19
• Manual cursor control	19

Player menu

Menu TOOLBAR - overview	21
• Play Option	22
• Slide Show	22
• View	22
• Search	23
• Program	23
Menu Preferences - overview	25
• Picture	26
• Advanced Picture	26
• Sound	27
• Features	28
Menu SETUP - overview	29
• Language	30
• TV	31
• Audio-Menu	32
• Speakers	33
• Movie Mode	33
• Music Mode	33
• Features	34
• Access	34

Installation, using the unit for the first time

Back panel connections	36
Setting up the DVD player	38
Wiring	39
Wiring diagrams	
• SADV 1245 R and SR 1535 R with S-Video and Vcomponent YUV Video	40
• SADV 1245 R in combination with DD 1535 R and PA 1535 R (S-Video-mode)	41
• SADV 1245 R connected to a stereo amplifier	42
• SADV 1245 R connected to a surround amplifier	43
Safety notes	44
Approved usage	45
Fitting new batteries	45
Care of the unit	45
Device approval and conformity with EC directives	45
FCC Information to the user	45

Miscellaneous

Explanation of terms, useful information	46
Technical description OVERSAMPLING	48
• Standard OVS FIR filter	48
• OVS 1 (short FIR filter)	48
• OVS 2 (Bezier interpolator plus IIR filter)	48
• OVS 3 (pure Bezier interpolator)	48
• SACD Operation	49
Trouble-shooting	50
Specification	53

Front panel controls

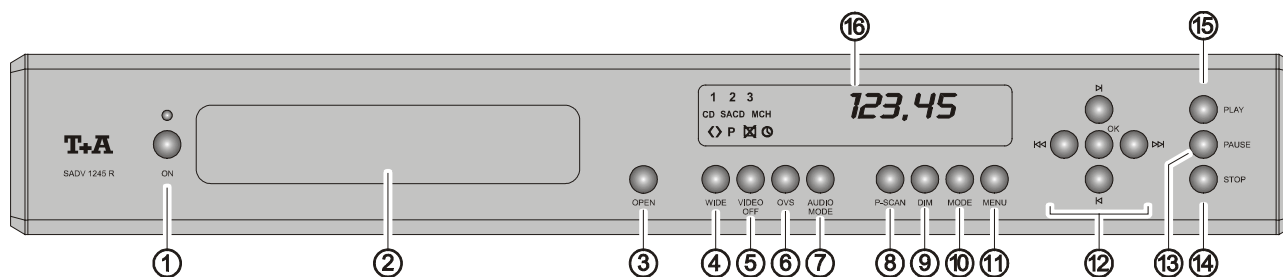

① ON

On / Off switch.
The green LED glows when the unit is switched on and ready to use.

Note:

If the **SADV 1245 R** is connected to a pre-amplifier, integrated amplifier or receiver within an 'R' system, it can be switched off, with the whole system, by pressing the button on the remote control handset.

Note:

The mains button does not disconnect the device from the mains completely. Some parts of the circuit are still live when the unit is switched off.

② CD Drawer

The drawer of the **SADV 1245 R** consists of a combination of a special plastic with good damping qualities, and solid, precision-machined treated aluminium. It's floating and flexible suspension system eliminates the transfer of mechanical vibration to the disc, which can have an adverse effect on the sound.

③ OPEN

Button for opening and closing the drawer.

④ WIDE

With this button, the bandwidth of the analogue output filter for SACD playback can be switched between 60 kHz (normal mode) or 100 kHz ('**WIDE**' mode).

A security switch at the back panel of the **SADV 1245 R** must be set to the '**WIDE ENABLE**' to allow the wide bandwidth position to be chosen. '**WIDE**' mode cannot be chosen without the security switch set to '**WIDE ENABLE**' (also see: chapter '**Back Panel Connections**').

Note:

The position '**WIDE**' should only be used in combination with amplifiers that are capable of reproducing audio frequencies up to or beyond 400 kHz. If in doubt, please consult the manual of your amplifier or ask the manufacturer.

In combination with all **T+A** amplifiers the '**WIDE**' position can be used without limitation.

⑤ VIDEO OFF (CD and SACD only)

With this button the video section of the **SADV 1245 R** can be switched off.

When switched off the high frequency video signals can not influence the susceptible audio signals. Switching off the video section is recommended for highest possible audio reproduction quality.

⑥ OVS

Selection of the oversampling method

Repeatedly pressing this button cyclically steps through the various oversampling algorithms offered by the **SADV 1245 R**.

For SACD and CD playback each have two different sets of oversampling algorithms. These special algorithms implemented in the **SADV 1245 R** are optimised for each data format.

A detailed description of the oversampling algorithms can be found in chapter '**Technical Description Oversampling**'.

⑦ AUDIO MODE

Selects the audio playback mode

• SACD

- When the disc is stopped this button chooses between the CD or SACD layer of hybrid SACDs.
- During playback of SACDs with stereo and multichannel areas this button toggles between stereo or multichannel playback.

• DVD

- Selection of the DVD sound track (language or audio format), if there are different sound tracks on the disc.

8 P-SCAN

A long key press (approx. 3 sec.) switches the progressive scan mode for the YUV component video output on and off. Progressive scan increases the picture quality dramatically but it requires a progressive scan capable projector or TV set.

IMPORTANT Note:

Before switching to progressive scan mode, please make sure that your video monitor or TV set is capable of displaying progressive video signals! Please consult the manual of your video monitor or ask the manufacturer.

If the monitor is not capable of displaying progressive video signals, a distorted or no picture at all will be displayed. In this case please **immediately** switch back to normal video mode.

Note:

The **SADV 1245 R** is equipped with a state-of-the-art Faroudja™ video processor with DCDi® technology. To optimize the picture quality some video parameters can be adjusted in the menu **'Preferences/Adv. Picture'**. Please refer to the chapter **OSD MENU**.

9 DIM

Adjustment of the display brightness

By repeatedly pressing the **DIM**-button the brightness of the alpha-numerical display can be adjusted in 3 steps:

1. **Normal setting:**
good legibility, even in bright conditions and sunlight.
2. **Subdued:**
Subdued setting, for dark locations.
3. **Display off:**
the screen is switched off completely. The screen lights up for a few seconds whenever a command is sent to the unit, so that you can see the new setting.

10 MODE

Selection of the **REPEAT**-mode.
(see chapter **'Operation of the SADV 1245 R'**).



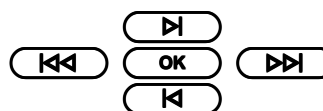

11 MENU

A **short keypress** opens the disc menu of a video DVD. (see chapter **'Menu-Functions'**).
A **long keypress** (approx. 3 sec.) opens the **SETUP Menu** of the **SADV 1245 R**.

12 Cursor block (multi function buttons)



These multi-function buttons are used for navigation within On-Screen-Menus and for play back control (track jump, cueing etc.)

	Menu- Navigation	Play Back Control
 	selection buttons	These buttons are used to jump to the next / previous track, chapter or title. For MP3 music discs these buttons select a title within the current directory.
 	adjustment buttons	Fast Forward / Reverse The fast mode is ended by pressing the PLAY button. For MP3 music discs these buttons select the active directory on the disc.
	confirm button	A short keypress will start the playback or will resume playback after a pause. A long keypress will switch to CURSOR-Mode (NAVIGATION Mode) (see chapter 'Manual Cursor-control').

13 PAUSE

A short press on this button switches the unit to **Pause / static picture**. Press the **PLAY**-button to resume playback.

During DVD playback repeated **short presses** of the **PAUSE** button move on to the next single frame of the film.

Repeated **long presses** (around 2 seconds) during DVD playback switch to different slow motion speeds. Press the **PLAY**-button to stop slow motion.

14 STOP

The **STOP** button ends playback.

15 PLAY

A short press on this button starts playback, or resumes playback after a **Pause**.

16 Screen window

All the screen elements of the **SADV 1245 R** are displayed in a clearly laid-out window on the integral screen:



1 / 2 / 3	This display area shows the currently active oversampling algorithm (1...3). If none of the numbers are lit, the standard algorithm (FIR Filter) is active.
CD	is lit if a standard audio CD or the CD layer of a hybrid disc is played
SACD	is lit when a SACD is played
MCH	is lit if a multichannel track is played
<>	This indicator is lit, if the analog output of the SADV 1245 R is switched to high bandwidth (WIDE-mode).
P	indicates that the P-scan mode (progressive scan) is active for the YUV component video output
X	this indicator is lit, if the video output is switched OFF (pure high quality AUDIO-Mode).
123,45	Alpha-numerical display area for indication of track, time or operation mode. This area is also used for context depending messages for example during SETUP menus.
O	This indicator is lit, if the WAKE-UP function is active. (see chapter ' Preferences / Functions / Wake Up Timer ').

Note:

In case the message '**OVERHEAT**' is displayed on the display, the **SADV 1245 R** has become too hot. Please make sure that the device is sufficiently supplied with cooling air and that the air can freely flow around the case of the device. Read and follow all instructions given in chapter Setting up the **SADV 1245 R**. Please do not place the **SADV 1245 R** directly on top of other hot devices like amplifiers etc.

Remote control of the SADV 1245 R

General

The **SADV 1245 R** can be remote operated with the **T+A** remote controls **F6** and **F12** or with the system control **F1**.

On the following diagrams all buttons used for the control of the **SADV 1245 R** are marked '■'. All other buttons are without function for the **SADV 1245 R**.

The **SADV 1245 R** receives remote control commands from the **RLINK** –Master device (amplifier or surround-receiver). It is switched ON with the **CD/DVD** button.

Note:

If there is no master unit present, the **SADV 1245 R** can be directly remote operated with the remote control set (FBS12, FBS6) which is available as an optional accessory.

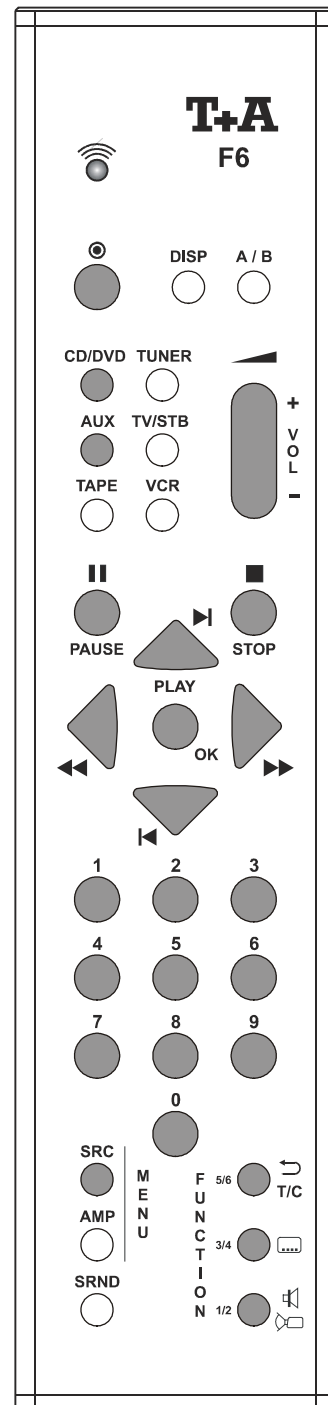
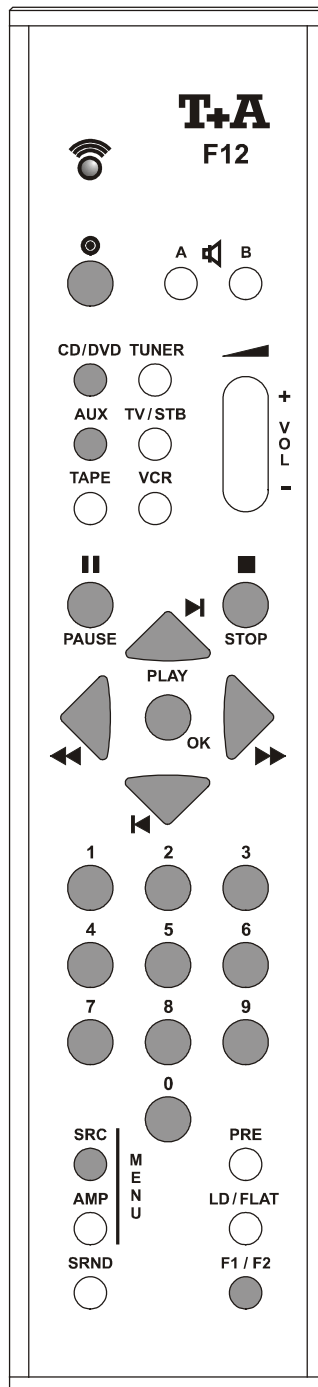
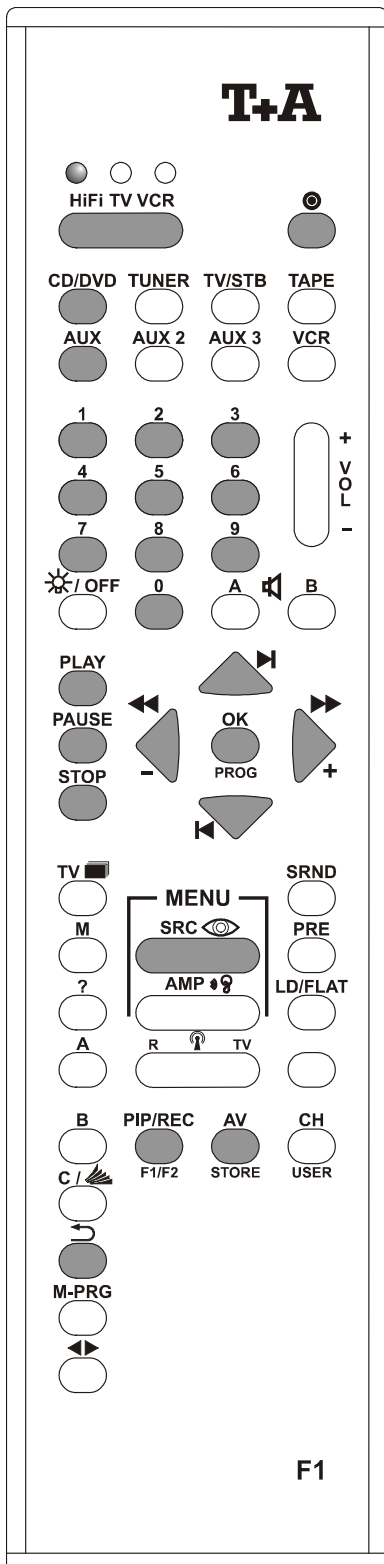

F1	F12	F6	
			Switches DVD player to stand-by
			Switch to HiFi control
 	 	 	Switches DVD player on, selects DVD as program source - Switches SADV 1245 R ON , if RLINK 2nd ADDR = AUX ist selected (switch on back panel)
			start playback, re-start playback after pause
			In STOP mode: Starts playback (PLAY) During playback: Selects next title MP3-CD: Select the next track within an album directory
			Selects previous title MP3-CD: Select the previous track within an album directory
 	 	 	Fast rewind / forward MP3-CD: Select the album
			brief press: Ends following modes: PAUSE / SEARCH / SCAN long press: Switches to cursor control (see ' <i>Manual cursor control</i> ') MP3-CD: Start playback
			brief press: Interrupt playback Next individual DVD frame long press: Slow motion: $\frac{1}{2}$, $\frac{1}{4}$, $\frac{1}{8}$ speed
			brief press: End playback long press: Open drawer
 	Number buttons: direct track / chapter select
			select REPEAT mode
			brief press: changes between different sound tracks (languages or DOLB/dts/stereo sound) if there are multiple sound tracks on the disc (same function as button on the front panel) long press: Camera view angle
			brief press: Open Disc menu (see ' <i>Menu function</i> ') long press: open SETUP on-screen menu
			select sub title language
<p>Menu control</p>			<p>In Select menus the following buttons are used for navigation within the menu:</p> <p>left up right</p> <p> down</p> <p>Select / confirm button [ENTER]</p>

Operating the SADV 1245 R

Switching on

Press the **ON** button on the front panel of the unit. The green indicator LED above the button lights up, as does the display screen. The unit is now ready for use.

For Stereo playback (CD /SACD) switch ON your HiFi system and select the audio input the **SADV 1245 R** is connected to.

For playback of SACD multichannel discs select the analogue 5.1 or 7.1 multichannel input of your surround amplifier or surround receiver.

For playback of DVDs select the appropriate digital input of your surround decoder or surround receiver. Switch on your TV set and choose the video input to which the **SADV 1245 R** is connected to.

Loading a Disc

1. Press the **OPEN** button on the front panel to open the drawer.
2. Place the disc in the **centre** of the circular recess in the drawer, **with the side to be played facing down**.

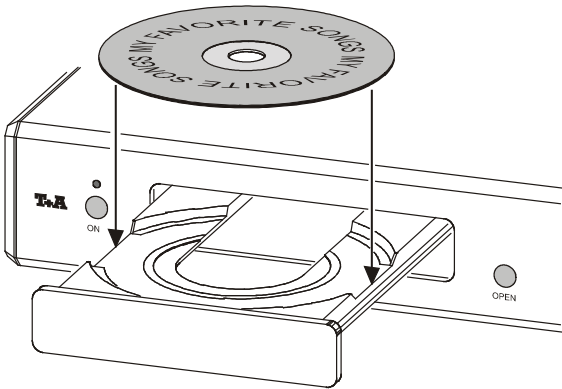

3. Press the **OPEN** button on the front panel to close the drawer.

Note:

After closing the disc tray, the **SADV 1245 R** automatically selects the playback mode suited best for the format of the disc /Stereo for CD, MCH for DVD and SACD).

Please make sure that for SACD playback the 5.1/7.1 multichannel input and for DVD playback either the digital input or the 5.1/7.1 multichannel input of your surround amplifier/receiver is selected.

For CD playback either the stereo- or the 5.1/7.1 MCH Input of your amplifier can be used.

Starting playback

Some discs feature an "autostart" function. These discs will start automatically. Other DVDs show an On-Screen-Menu after start-up. Please follow the instructions of the menu.

CD and SACD are started by pressing the **PLAY** button.

Stopping playback

You can stop playback at any time by pressing the **STOP** button.

Resuming playback

You can resume playback of a stopped CD / DVD / VCD by pressing the **PLAY** button on the front panel, or the **▶** or **OK** button on the remote control handset.

RESUME



After loading a previously played DVD/VCD the playback can be continued at the position where the playback was interrupted before. Please press the **PLAY** / **OK** button while the **'RESUME'** icon is displayed on the screen.

Note:

Some discs suppress the resume function in which case, these discs can only be started from their disc menu. The **RESUME** function is available not only for the DVD played last, but also for the last four DVDs that were played.

Selecting a Chapter or Title



1.) Selecting using a skip button

You can initially select CD tracks, DVD titles or chapters by pressing the skip forward button  or the skip back button  repeatedly until you reach the desired point.

Note regarding DVD:



If the last chapter of a title is reached, the machine skips automatically to the previous or following track.

2.) Selecting using the DVD disc menu

Most DVDs feature a Select menu for titles and scenes in a film. Once you insert a DVD this menu usually appears automatically. During playback the disc menu can be opened at any time by pressing the  button on the front panel or the blue  button of the remote control briefly (F1: blue  rocker).

Select the desired scene in the disc menu and confirm your selection by pressing the  button. Playback will jump now to the selected scene.





3.) Selecting chapter and track - direct numeric input

It is also possible to select a DVD chapter or CD track by entering the number of the section using the numeric buttons ( ... ) on the remote control handset.

Note:

If the number has more than one digit, press the digits quickly in sequence.

SEARCH

The standard search takes place at quadruple speed, and is started by pressing the front panel buttons  /  or the remote control buttons  / . Press the search button again to increase the search speed to 32 times normal speed. The search can be stopped at any time by pressing the  button.

The sound is muted during the search process.

SEARCH via the On-Screen-Menu

The search function can also be controlled by the OSD (see '*Menu Toolbar/Search*').

REPEAT

The device offers several **REPEAT**-modes for repeating chapters, titles or entire discs:

- DVD Chapter / Title / Disc / Off
- VCD/CD Title / Disc / Off
- MP3 Track / Album / Disc / Off
- SACD Title / Area / Off
- JPEG Repeat Roll / Repeat Disc

REPEAT mode	Screen display (short message)	Screen display (persistent)
Chapter	REPEAT	RC
Title Track	RPT TTL RPT TRK	RT
Disc Repeat Disc	RPT DSC	RP
Off	RPT OFF	
Area Album	RPT ARA RPT ALB	RA
Repeat Roll		RR

To switch on and select a **REPEAT** mode press the  button on the front panel repeatedly until the desired mode is displayed.





REPEAT using the F1/F6 remote control handset





- The **REPEAT**-modes can be selected with the  button.

Play back of MP3 / JPEG / Kodak Picture CD

The **SADV 1245 R** can play back MP3, JPEG, VCD and SVCD files from recorded available CD-R/RW discs or from commercially available CDs.



A MP3-CD may contain up to 32 album files (directories) with music titles.

To select an album file use  /  buttons on the front panel or the  /  buttons of the remote control.

To select one title/track within a directory  /  buttons on the front panel or the  / -buttons of the remote control.

The desired album / title number can alternatively enter directly using the numerical buttons of the remote control:

- In STOP-mode the number buttons are used for the album selection.
- During PLAY the number buttons select a track within the current album.

Play back of a MP3 title can be paused by pressing the  button and be resumed by pressing the  button.

Note:

Due to the big number of tracks on a MP3 discs it may last a couple of seconds until the disc structure is read and entirely resolved by the player.

Only the first session of Multi-Session-Discs is supported by the **SADV 1245 R**.

The following formats are supported:

- CDs according to ISO 9660
- max. 30 characters
- max. 8 directory levels
- max. number of albums: 32
- VBR-bit rate supported
- sampling frequencies for MP3-CD: 32 kHz, 44.1 kHz, 48 kHz
- supported bit rates for MP3-CD: 32, 64, 96, 128, 192, 256, 320 (kbps)

following formats are **not** supported:

- *.WMA, *.AAC, *.DLF, *.M3U, *.PLS
- file names containing chinese symbols
- disks containing sessions not closed (Non Session Closed)
- discs recorded in UDF-format
- files containing ID3V2 tags

Listening to SACD

It exist three types of SACD discs: single layer, double layer and hybrid discs. The hybrid discs contain a standard CD and a SACD layer.

The SACD layer should always contain the music in a pure stereo format. Additionally it may contain the music in multi channel format. Some rare discs however contain only multi channel signals on the SACD layer. The **SADV 1245 R** can play back all of these discs. Please follow the instructions below.

Play back of Super Audio CD (SACD)

Stereo SACD

- The player will automatically select the stereo SACD layer as the default. After reading the disc, the SACD indicator will light up.
- Now the disc may be started by pressing the **PLAY** button.

SACDs containing a stereo and multi-channel area

- After loading and reading such a disc, the player will automatically select the stereo SACD area as the default. This is indicated by the SACD indicator.
- Start the disc by pressing the **PLAY** button.

• Note:

If you want to play back the multi-channel part of the disc, press the **AUDIO MODE** button (repeatedly) until you get the indication '**SACD MCH**'. If you now start the play back by pressing the **PLAY** button, you will hear the multi channel part of the disc through the multichannel analogue output of the **SADV 1245 R**.

Play back of the CD layer of hybrid SACD discs

The **SADV 1245 R** can play back both of the SACD and the CD layer of these discs. Switching between CD and SACD layer is accomplished by pressing the **AUDIO MODE** button while the disc is stopped. After switching to the CD layer, the "CD" indicator in the display will be lit.

Note:

During play back it is not possible to switch between CD and SACD layers. First stop a playing disc before switching layers.

Compatibility with recordable media

The **SADV 1245 R** can play back recordable and rewritable discs (for details refer to the technical data section of this manual).

Due to the vast number of different disc types, disc manufacturers, disc recorders and software programs a guarantee for compatibility with every software / hardware / disc combination can not be given.

If compatibility problems occur we recommend to use a different type of disc, a different recording device and/or a different software.

Hints for using the SADV 1245 R in combination with SR 1535 R and DD 1535 R

Wire the system according to the diagrams and execute all steps described in the chapters '**Setting up the SADV 1245 R, Wiring and Safety Notes**'.

Operation of **DD 1535 R** (software version > 1.10)

- For DVD (S/VCD) playback choose the DVD input.
- For playback of CDs in Stereo mode choose "CD" as source and switch to PREAMP-mode. You will now hear the CD in highest possible sound quality over the excellent D/A converters of the **SADV 1245 R** and the short direct and audiophile signal paths of your **T+A** stereo amplifier.
- To play back CDs in ProLogic or NEO:6 surround mode choose CD as source and switch your system to SURROUND mode (green SRND button). You can now choose the surround mode using the main menu of your **DD 1535 R**.
- For playback of SACDs choose 'CD' as source and switch to the multi-channel input of the DD1535R (green **SRND**-button).

Operation of **SR 1535 R** (software version > 1.20)

- For DVD (S/VCD) playback choose the DVD input.
- For playback of CDs in Stereo mode choose 'CD' as source. You can now select a sound mode (Stereo, Surround, Sound Fields etc.) by pressing the green **SRND** button.
- For stereo reproduction in the highest quality, switch to HIGH-QUALITY mode using the **FLAT** button underneath the flap of the **SR 1535 R**.
- For playback of SACDs choose 'CD' as source and switch to the multi channel input (MCH-IN) with the green **SRND** button. You will now hear the SACD in Stereo or multi-channel mode depending on the audio mode setting of the **SADV 1245 R** (see **AUDIO MODE** button).



Menu Functions of the SADV 1245 R



General

During operation of the SADV1245R two different menus are available: the disc menu and the player menu.

- The **Disc-Menu** is stored on the DVD itself. This menu is intended for selecting and operating special features of the disc like sound-track, subtitles, additional information on the film, film trailers, games etc.

Contents and navigation/operation of the disc menu differ from disc to disc. Normally this menu is operated by the buttons described below. Please follow the instructions given on the screen.











The disk-menu is opened by a brief press of the  button on the front panel or the  button of the remote control.

- The **Player-Menu** is intended for the control of special functions and settings of the player. This menu is described in detail in the following chapters. The player menu is opened by a long press (approx. 3 sec.) on the  button on the front panel or the  button of the remote control.

The Player menu will be automatically closed after a short while, if no further navigation or button presses are executed.

Menu control

In selection menus the following buttons are used for navigation and selection:

Remote Control	Front Panel	
		upwards
		downwards
		left
		right
		Confirmation button [ENTER]

DVD / VCD Disc Menu

(menu operation and navigation)

A DVD may contain a Disc Menu with selection facilities for individual **titles** and / or **chapters**. Depending on the DVD, the disc may also contain games, bonus material or alternatives for camera angle, synchronous languages or sub-titles, which can be set or called up via the Disc Menu.

Note:

The contents, appearance and behaviour of the Disc Menu are dictated and controlled by the disc itself. If you encounter problems in connection with the Disc Menu, please contact the manufacturer or retailer of the disc.

Calling up and operating the DISC Menu

The **Disc Menu** can be called up at any time during playback, in order to make adjustments.

- To enter the disc menu, briefly press the **MENU** button on the front panel or the **SRC** button of the remote control.
If the DVD contains a Select menu, this now appears on the TV screen. The integral screen displays the message **'INFO'**.
- Select a menu item by navigating with the cursor keys (**↖**, **↗**, **↙**, **↘**) or by entering a number (if numbers are given in the menu).
- To select or execute a menu item, press **OK** button [**ENTER**].
- To close the disc menu press the **MENU** button on the front panel or the **SRC** button of the remote control.

Opening and closing the menu using the F1 remote control handset

Press the blue **SRC** - rocker to call up the Disc Menu.

Press the blue **SRC** - rocker again to leave the menu.

Manual CURSOR control

The **CURSOR** buttons on the remote control handset

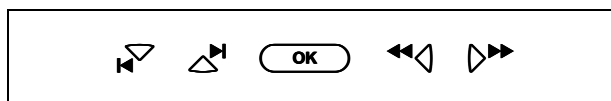

are used with the **SADV 1245 R** both to control the functions of the mechanism (skip back, skip forward, search) and also to navigate within menus. The **SADV 1245 R** detects automatically whether you are operating the disc mechanism or finding your way through a menu.

A few DVDs, mostly older and quite rare examples, give the machine no clues whether a menu is currently open, i. e. they do not pass relevant information to the player. With these discs the screen display **'INFO'** does not appear when a menu is open, and it is not possible to navigate within the menu. In such cases the **SADV 1245 R** can be switched to **'Cursor Navigation'** mode.

Switching to CURSOR control

Hold the **OK** button pressed in until the message **'CURSOR'** appears on the integral screen. Now even problematic menus can be operated.

Switching off CURSOR control

To revert to normal operation hold the **OK** button pressed in again until the **'CURSOR'** message on the screen disappears.

Note:

In Cursor mode the buttons of the control button block carry out menu control functions exclusively.

For normal control of the disc mechanism you must therefore first leave Cursor mode.

Menu TOOLBAR - overview

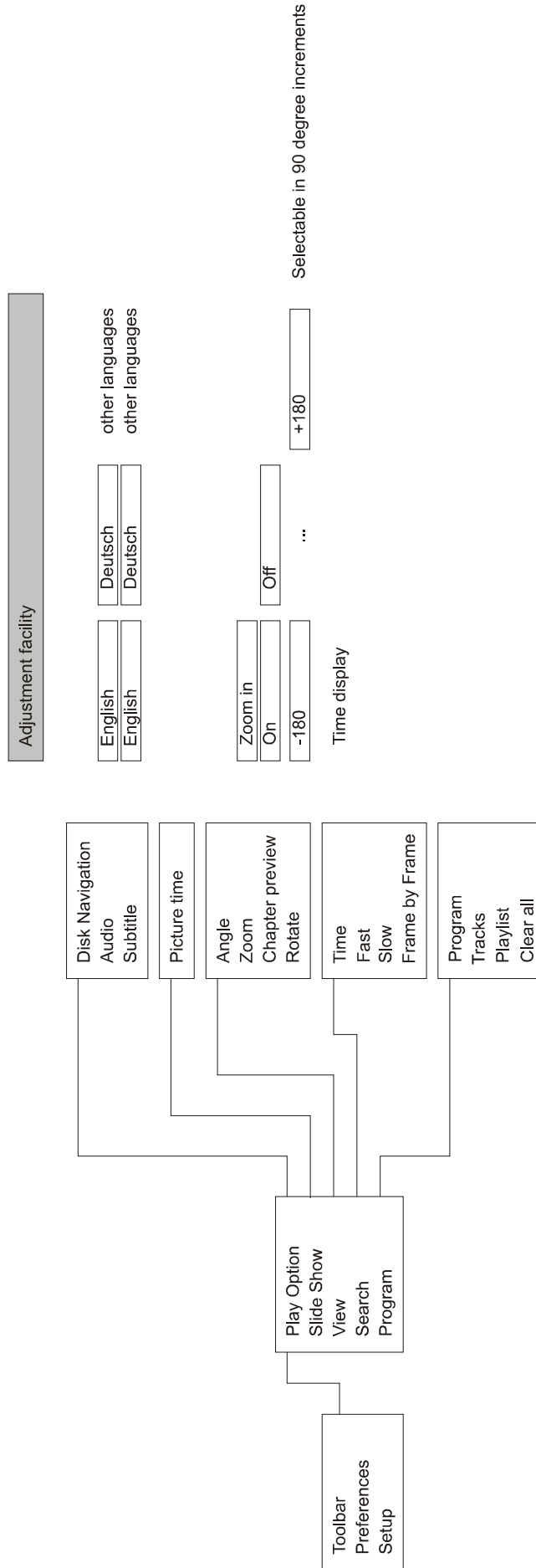

Menu Toolbar

In this menu the playback options for the disc can be selected.

Menu Play Option

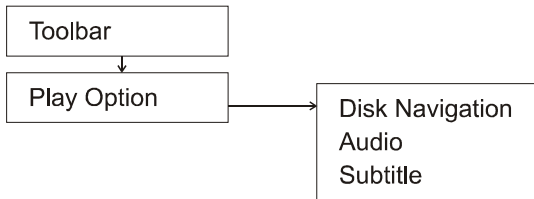

Adjustment facility

English	Deutsch	other languages
English	Deutsch	other languages

Disk-Navigation

Submenu for title / chapter selection.

Audio / Subtitle

Submenus for the selection of audio language and subtitle language. Only languages present on the disc can be selected. The default language selection can be set in the menu '**Preference / Language**'.

Menu Slide Show (Special menu function for picture-DVDs)

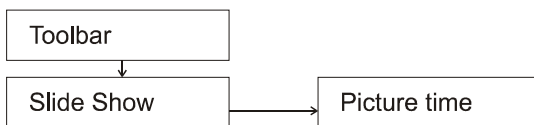

Adjustment facility

The **SADV 1245 R** can perform an automatic slide show with the content of a JPEG picture CD. This submenu serves to adjust the display time for each slide.

- Slow - 8 seconds display time
- Medium - 5 seconds display time
- Fast - 2 seconds display time

Menu View

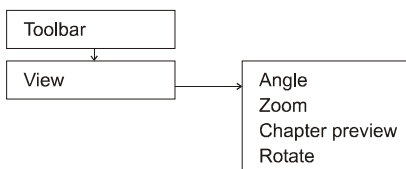

Adjustment facility

Zoom in	Off	
On		
-180	...	+180

Selectable in 90 degree increments

Angle

If a DVD contains sequences filmed from different viewing angles, this submenu lets you select one of these angles for playback.

Note: Which angles can be selected (if any) is depending on the content of the disc.

Zoom

The ZOOM function allows you to magnify certain portions of the screen picture.

Chapter Preview (Scan function)

Choosing "ON" in this submenu will play a short preview of each chapter on the disc.

Rotate

(Special menu function for picture-DVDs)

This submenu lets you rotate the pictures in 90 degree steps to align the orientation of the slides of a picture CD with the TV.

Note:

This function can not be called during a slide show. All pictures on the disc must have the same orientation.

Menu Search

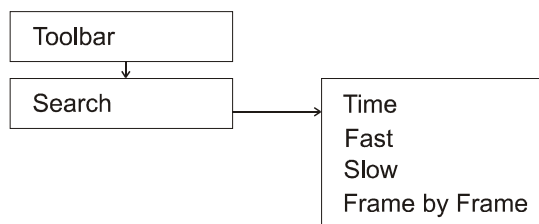

Adjustment facility

Time display

Time

This submenu lets you enter a time position on the disc where playback shall be started.

Use the numerical buttons of the remote control to enter hour, minutes and seconds. Then press **OK** to confirm your selection. Playback will now start at the selected position.

Note:

This function is not available for VCD / SVCD.

Fast

Here you can select the speed for fast forward search. During search the audio output will be muted.

Slow

Here the slow motion mode can be activated. Choose 1 to return to playback at normal speed. During slow motion mode the audio output will be muted.

Frame by Frame

Choosing this menu item will let you step through a film frame by frame. Use the **◀◀** / **▶▶** buttons to step backwards or forward.

Menu Program

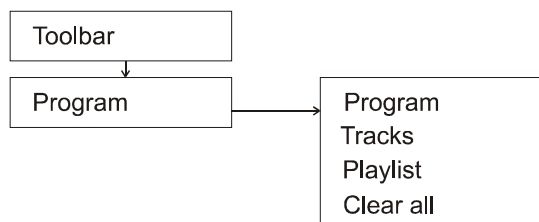

Adjustment facility

You can play back the contents of a disc in your preferred order by programming the order of the tracks to be played.

Program

This submenu displays the titles already programmed. Choose the setting 'ON' and then press the **▶▶** button.

Tracks

This submenu lets you enter tracks into a playlist for the disc in the player.

In the selection window on the screen navigate to the desired track and select it by pressing the **OK** button. In this way a playlist with up to 20 tracks can be created.

Playlist

This submenu lets you edit a playlist and remove tracks from it.

Enter this submenu and choose a track to be deleted. Confirm your selection by pressing the **OK** button. This removes the track from the list.

Clear All

If you want to delete the complete playlist, choose the menu entry "Clear All" and press the **▶▶** button to confirm. The current playlist will now be deleted.

Menu Preferences - overview

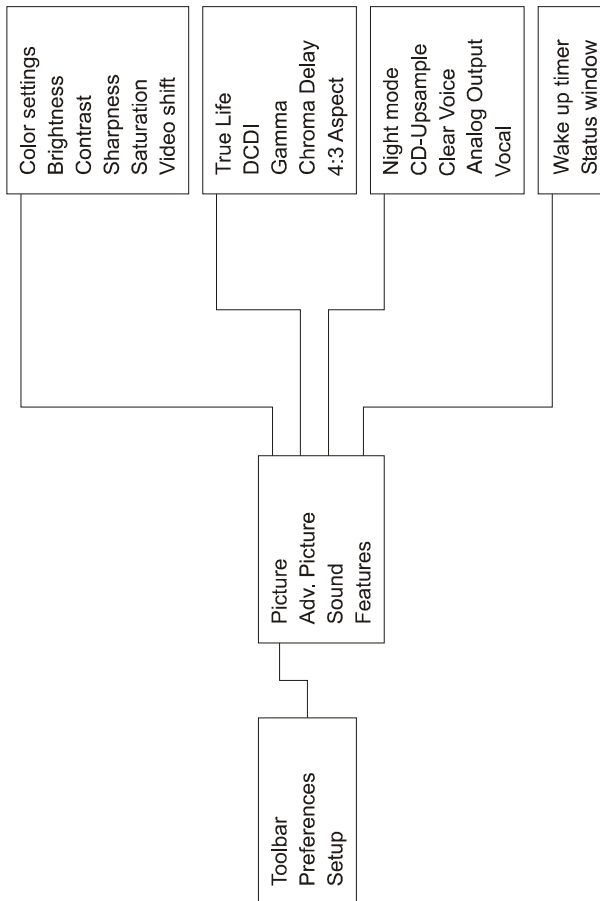
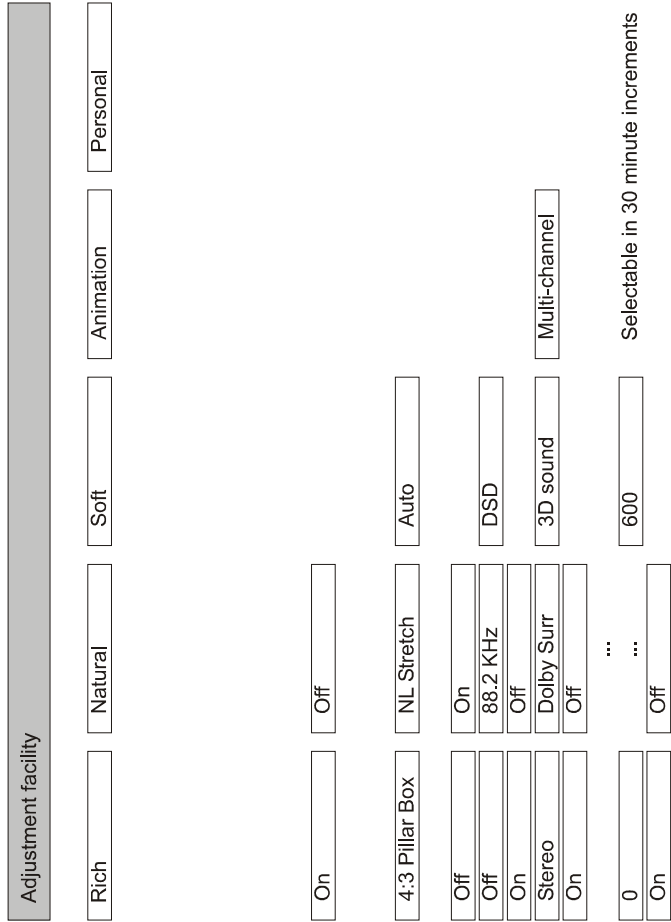

Menu Preferences

Menu Picture

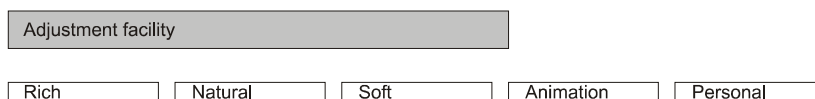
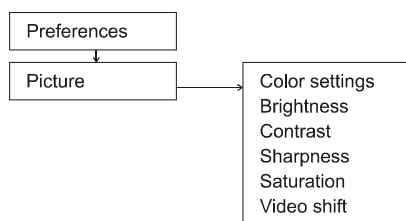

The menu Picture lets you adjust the picture parameters to your personal preferences.

Color Settings

(will not influence the YUV Component video output)

In this menu you have the choice between different pre-defined color settings or one adjustable setting (personal).

Brightness / Contrast / Sharpness / Saturation

(will not influence the YUV Component video output)

Use these submenus to adjust all picture parameters to your personal taste. These adjustments will only influence the display monitor if the "personal" color setting is selected in the menu above.

Video Shift

The video shift function can be used to change the horizontal position of the picture and to center the picture on the screen.

Menu Advanced Picture (for YUV-video-output only)

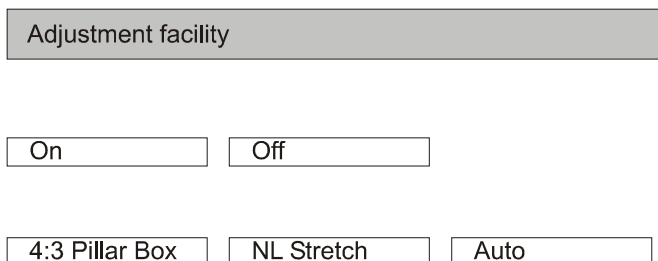
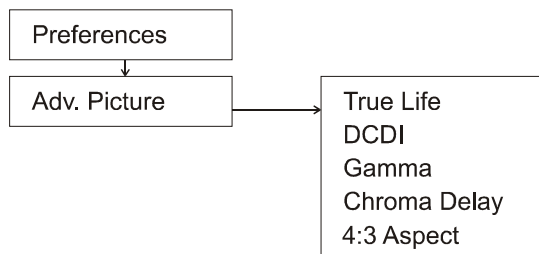

True Life (for progressive scan output only)

Generates a more dynamic picture by increasing the contrast and saturation of the picture.

DCDi (for progressive scan output only)

DCDi computes the angle of certain picture contours to interpolate additional video pixels. 'On' increases dramatically the picture quality, especially during slow motion.

Gamma

This submenu offers a non-linear processing of the picture intensity. Setting the slider in the right hand input box to a positive value will enhance fine details in dark scenes whereas a negative value will increase the contrast of the picture.

Chroma Delay

If the chroma (colour) and luma (brightness) signals are not perfectly aligned (due to phase delays in the signal transmission), the chroma delay setting can be used to eliminate misalignments. Adjust this value to obtain a perfect clear and sharp picture.

4:3 Aspect (for progressive scan output only)

Use this submenu to adjust the aspect ratio to the geometry of your video monitor.

4:3 LB (letter box) use this setting for 4:3 material on a 16:9 screen (without stretching)

NL-Stretch (non linear stretching) for display of 4:3 pictures on a 16:9 screen with non linear stretching. The outermost parts of the picture are progressively stretched, central parts of the picture are not altered. This feature gives a full screen picture format without black stripes and warping in the central parts of the screen.

Auto no adjustment of the aspect ratio. The picture is displayed exactly in the format stored on the disc.

Menu Sound

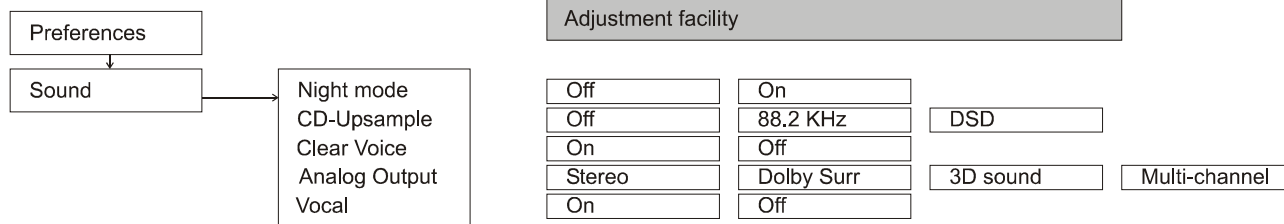

In this menu the basic settings for the sound reproduction are adjusted.

Night mode

Off The sound is reproduced with full dynamics. The difference between loud and soft passages may be very high.

On Sound reproduction with decreased dynamics. Loud passages will be played at a lower volume, during soft passages the volume is increased a little bit, especially in the dialog track. This mode decreases the difference between extremely loud and soft sequences. This sound mode is recommended, if neighbours or other members of the family should not be disturbed.

CD-Upsample

This submenu can be used to increase the sampling rate for audio signals digitally right in the DVD decoder.

Note:

This function will not be active in multi channel playback mode.

Attention:

Only if Upsampling '**OFF**' is selected the advanced **T+A** oversampling algorithms (see chapter Oversampling) can be used with maximum effect. For this reason we recommend to use the '**OFF**' setting.

Clear-Voice

Increases the volume of dialogues for a better comprehension.

Note: This function is available only if supported by the disc.

Analog Output

Sets the operation mode of the analogue Stereo output of the **SADV 1245 R**.

Stereo If stereo is selected multichannel sound tracks are down-mixed to stereo and output through the L/R front outputs of the main analogue output.

Please use this setting if your SADV 1245 R is connected to a stereo amplifier.

Dolby Surr Use this setting if your **SADV 1245 R** is connected to a Dolby-ProLogic decoder. Multichannel soundtracks will be output through the front L/R outputs of the multi channel analogue output of the **SADV 1245 R** in a Dolby ProLogic downmix version.

3D sound This setting will produce an artificial virtual surround signal which can be played back through normal 2-channel stereo amplifiers.

Multi-channel

If this setting is selected, multi channel soundtracks will be output through all channels of the 5.1 multi channel analog output of the **SADV 1245 R**. **For this setting a multi channel surround amplifier with an analogue 5.1 (7.1) multichannel input is required (see wiring diagrams 1,2 and 4).**

Vocal (Karaoke)

Allows the playback of multichannel Karaoke DVDs.

ON Karaoke channels are mixed to a normal stereo signal. Music and vocal channels of the recording are played back.

OFF The vocal channel of the recording is muted.

Menu Features

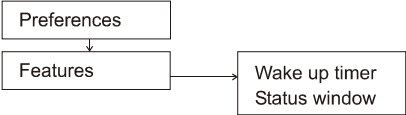

Adjustment facility

0	...	600	Selectable in 30 minute increments
On	Off		

Wake up timer

The **SADV 1245 R** will be switched on at the selected period of time. If the wake up timer is active the timer-LED in the display window will light up.

Status window

If the status window is switched on, the current operation mode and time information is displayed on the screen of the video monitor.

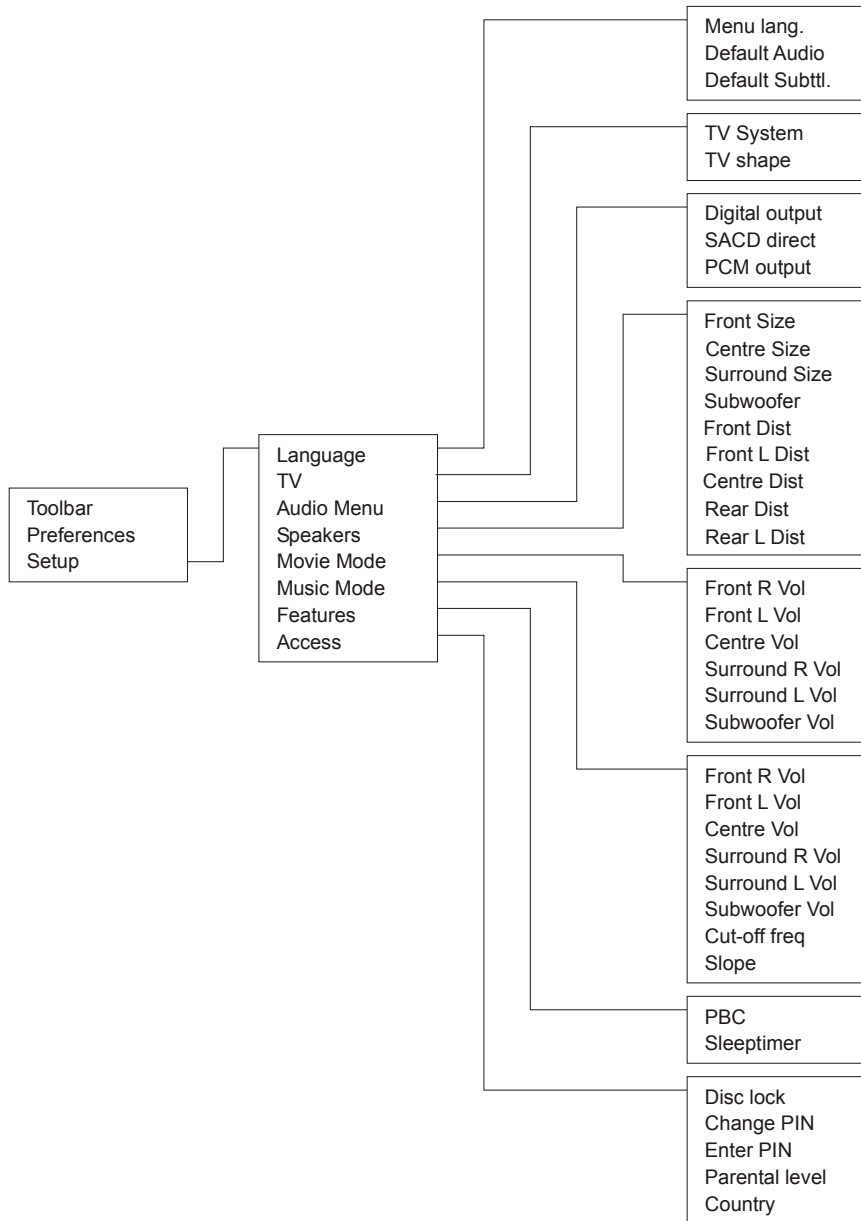

Adjustment facility

English	Deutsch	other language	
English	Deutsch	other language	
English	Deutsch	other language	
PAL	NTSC	Auto	
4:3 panscan	4:3 letterbox	Widescreen	
Off	PCM only	All	
On	Off		
96 kHz	48 kHz		
Small	Large		
Off	Small	Large	
Off	Small	Large	
Off	On		
1.0 m	...	5.2 m	Selectable in 0,3 m increments
1.0 m	...	5.2 m	Selectable in 0,3 m increments
1.3 m	...	3.4 m	Selectable in 0,3 m increments
1.0 m	...	2.8 m	Selectable in 0,3 m increments
1.0 m	...	5.2 m	Selectable in 0,3 m increments
-6	...	+6	Variable
-6	...	+6	Variable
-6	...	+6	Variable
-6	...	+6	Variable
-6	...	+6	Variable
-6	...	+6	Variable
-6	...	+6	Variable
-6	...	+6	Variable
60	80	100	120
12	18	24	
On	Off		
Off	On		

Menu Setup

If the SETUP menu is opened during playback, the disc is stopped. The playback will continue after closing the SETUP on screen menu.

Menu Language

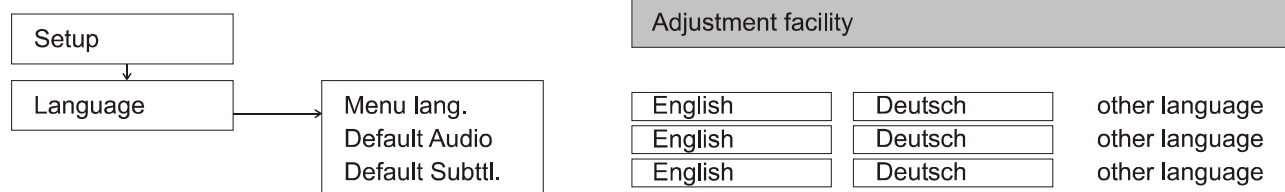

In this menu you can select the default values for the languages for sound track, subtitles and On-Screen-Menus.

Menu language

In this submenu you can select the language for the On-Screen SETUP menu.

Default Audio

Here you can select your preferred language for DVD soundtracks. The **SADV 1245 R** will play back a DVD in this language, if it is available on the disc.

Note:

The **SADV 1245 R** will use the default language of the disc, if your preferred language is not available on the disc.

Default Subttl.

In this menu you can select your preferred language for subtitles. If available on the disc the **SADV 1245 R** will show subtitles in this language.

It will use the default subtitles, if your preferred language is not available on the disc.

Menu TV

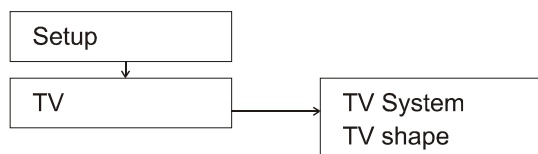

Adjustment facility

PAL

NTSC

Auto

4:3 panscan

4:3 letterbox

Widescreen

TV-System

The **SADV 1245 R** is compatible with both NTSC and with PAL video monitors.

PAL

Use this setting, if the picture shall be displayed on a PAL TV. DVDs in NTSC format are converted to PAL by the **SADV 1245 R** and output in standard PAL video mode.

NTSC

Use this setting, if the picture shall be displayed on a NTSC TV. DVDs in PAL format are converted to NTSC by the **SADV 1245 R** and output in standard NTSC video mode.

AUTO

If you select this setting, the **SADV 1245 R** will not convert signals between PAL and NTSC. All video signals will be output in exactly the format in which they are stored on the disc. Using this setting your TV must be compatible to the video standard of the disc which you want to play back.

We recommend this setting, if you use a multi standard TV set, which automatically detects the video standard and processes video signals accordingly.

Note:

Picture distortions can occur when switching between NTSC and PAL.

TV shape

This submenu lets you adjust the picture output of the **SADV 1245 R** to the geometry of your TV set.

Note:

The format selected must be available on the disc. Otherwise this setting will not have any influence on the picture display.

4:3 Pan Scan

For reproduction of a wide screen movie on a 4:3 TV without black top and bottom stripes. The left and right edges of the picture are slightly clipped.

Note: Pan Scan is not supported by all DVDs.

4:3 Letter Box

For wide screen reproduction on a 4:3 TV set with black top and bottom stripes.

Widescreen

For reproduction on a wide screen (16:9) TV set.

Optimum pictures on any screen		
	Video format	Film format
Original material		
Material on Disc		 Pan-Scan or distorted (anamorphic)
TV picture 16 : 9		
TV picture 4 : 3	 Normal	 Pan-Scan Letterbox

Audio Menu

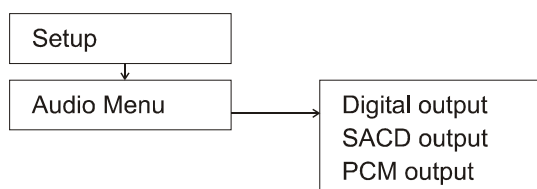

Adjustment facility

Off	PCM only	All
On	Off	
96 KHz	48 KHz	

In this menu the basic configuration for the audio output is done.

Digital output

Here the format for the digital audio output of the **SADV 1245 R** can be chosen. Please select the format that complies with your surround decoder / receiver

Off The digital audio output is switched off

PCM only Select this setting if your receiver / amplifier can only handle digital 2-channel signals. Multi channel formats (Dolby Digital, dts, etc.) are output as a 2-channel stereo downmix.

All Recommended setting in combination with a **T+A** surround decoder or receiver. Choose this setting if a multichannel decoder is connected to the digital output of the **SADV 1245 R**. Multichannel recordings are output as a digital multichannel data stream that can be decoded by the attached surround decoder / receiver.

Note:

Digital output signals are not available when playing a SACD.

SACD direct

ON The bass management function (see Menu '**Speakers**') is switched off (by-passed) for SACD playback.

Note:

In this operation mode all SACD audio signals are passed to the speakers exactly as they are stored on the disc. Low frequency signals are not redirected to a subwoofer or to the main speakers. This setting results in the highest reproduction quality provided the speakers are capable of reproducing full bandwidth audio signals.

⚠ All speakers of your system must be capable of full extended low frequency reproduction. For satellite speaker systems use the setting '**OFF**'!

Off The low frequency signals of SACD recordings are redirected to the subwoofer or main channel speakers.

Note:

Use this setting for all speaker systems with speakers that can not handle low frequency signals below 80 Hz with full power.

PCM output

In this submenu the 96 kHz digital output format can be enabled.

If you have selected 96 kHz output, DVDs with a 96 kHz / 24 bit audio format are output directly in this format without conversion. The highest audio quality is achieved in this mode.

Attention:

The decoder / amplifier or receiver attached to the digital output must be compatible with the 96 / 24 format. If this is not the case, select the 48 kHz format for the digital output.

Enabling the 96 kHz option for non compatible decoders / receivers can lead to damages of your amplifier/speaker system !

For **T+A** decoders and surround receivers the 96/24 bit format can be selected without restriction.

Menu Speakers

In this menu you can adjust speaker sizes, delays and the volume level for each speaker channel. These adjustments help to optimize the response of your system.

Note:

These settings have no effect for SACD playback, if in menu '**Setup /Audio Menu**' '**SACD output**' = '**ON**' is selected.

The speaker settings only influence the signals of the analogue multichannel output of the **SADV 1245 R**. They have no effect for the digital output signals.

Setup	Adjustment facility			
Speakers	Front Size	Small	Large	
	Centre Size	Off	Small	Large
	Surround Size	Off	Small	Large
	Subwoofer	Off	On	
	Front Dist	1.0 m	...	5.2 m
	Front L Dist	1.0 m	...	5.2 m
	Centre Dist	1.3 m	...	3.4 m
	Rear Dist	1.0 m	...	2.8 m
	Rear L Dist	1.0 m	...	5.2 m
				Selectable in 0,3 m increments
				Selectable in 0,3 m increments
				Selectable in 0,3 m increments
				Selectable in 0,3 m increments

Front Size / Centre Size / Surround Size

Off Choose this setting, if no speakers are connected to the channel

Large Choose this setting for all speaker outputs which are connected to large speakres, capable of reproducing frequencies below 50 Hz.

Small Setting for speaker outputs connected to small (satellite) speakers.

Subwoofer

On if a subwoofer is present in the system

Off if no subwoofer is present in the system (in this case at least the front channels require large speakers).

Front Dist./ Front L Dist. / Centre Dist. Rear Dist./ Rear L Dist.

Adjust these settings according to the speaker distances from your listening position.

Menu Movie Mode

Setup	Adjustment facility				
Movie Mode	Front R Vol	-6	...	+6	Variable
	Front L Vol	-6	...	+6	Variable
	Centre Vol	-6	...	+6	Variable
	Surround R Vol	-6	...	+6	Variable
	Surround L Vol	-6	...	+6	Variable
	Subwoofer Vol	-6	...	+6	Variable

With the help of this submenu you can adjust the volume for each speaker channel to acheive equal volume for all channels at your listening position.

Menu Music Mode

Setup	Adjustment facility				
Music Mode	Front R Vol	-6	...	+6	Variable
	Front L Vol	-6	...	+6	Variable
	Centre Vol	-6	...	+6	Variable
	Surround R Vol	-6	...	+6	Variable
	Surround L Vol	-6	...	+6	Variable
	Subwoofer Vol	-6	...	+6	Variable
	Cut-off freq	60	80	100	120
	Slope	12	18	24	

This menu is used to adjust the volume of each speaker channel for SACD playback.

Menu Features

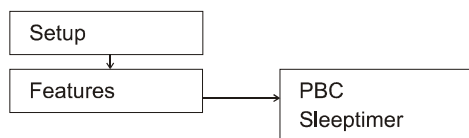

Adjustment facility	
On	Off
Off	On

PBC

The play back control function can be set to 'On' or 'OFF'. If 'On' is selected, the disc menu (if available on the disc) can be accessed and will displayed on the TV. Note: This function is available for video CDs (VCD) version 2.0 only

Sleeptimer

The Sleptimer, if switched on, will switch the **SADV 1245 R OFF**, if the playback is stopped for more than 20 minutes.

Menu Access

To gain access to the submenus of this menu, you must enter your four digit PIN number first in the submenu 'Enter PIN'.

The factory setting for the PIN code 0000. This code can be changed any time (see '**Change PIN**'). In case you have forgotten your PIN number, please follow the instructions given in chapter '**Trouble shooting**'.

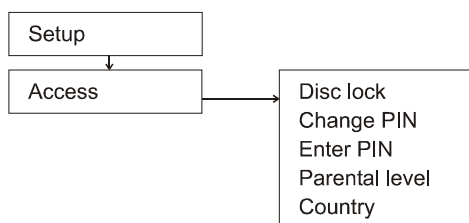

Adjustment facility

Disc lock

You can lock certain of your DVDs to prevent unauthorized playback of these discs.

After a DVD is locked, you will be prompted for your PIN number before this DVD can be started. Without a valid PIN number this DVD will not be played back on this player.

Change PIN

First enter your PIN number in submenu '**Enter Pin**'.

Then navigate to the '**Change PIN**' submenu. Here enter your PIN number once again. After that enter your new PIN number twice.

The new PIN number is now valid. Please remember this PIN number well.

Enter PIN

Enter your four digit PIN code in the input box. After entering a valid PIN number all other submenus of the ACCESS menu will be accessible.

Note:

The factory default PIN number is **0000**

Country

Access level codes (Parental Level) are only valid for the country specified on the disc (set by the disc manufacturer). For this reason it might be necessary to set the access level for certain discs manually.

Parental level

Some DVDs have a children's access control which can block some scenes or the entire disc from viewing.

In this submenu you can enter an access level for the disc in the player. This level will be stored for this disc. From now on scenes of this disc with a level higher than the level you have entered will not be played or will be replaced by alternative scenes (if available on the disc).

Note:

VCD-, SVCD- or CD-Discs as well as most illegal DVD copies do not have a parental level feature.

Explanation of the parental level codes:

- 8 Suitable for adults only, not to be viewed by children.
- 7 Not suitable for children under 17.
- 6 Viewing with supervision by adults; it is recommended that children under 17 should not watch these discs without the presence of a parent.
- 4 Not suitable for children under 13.
- 3 Viewing with supervision by a parent recommended.
- 1 Suitable for all ages.
- 0 no parental level control available on this disc.

Installation

Using the unit for the first time

Safety notes

This chapter describes all the matters of fundamental importance for setting up and operating your DVD player. This information is not relevant to your daily handling of the system, but should still be read and noted carefully before using the machine for the first time.

Back panel connections

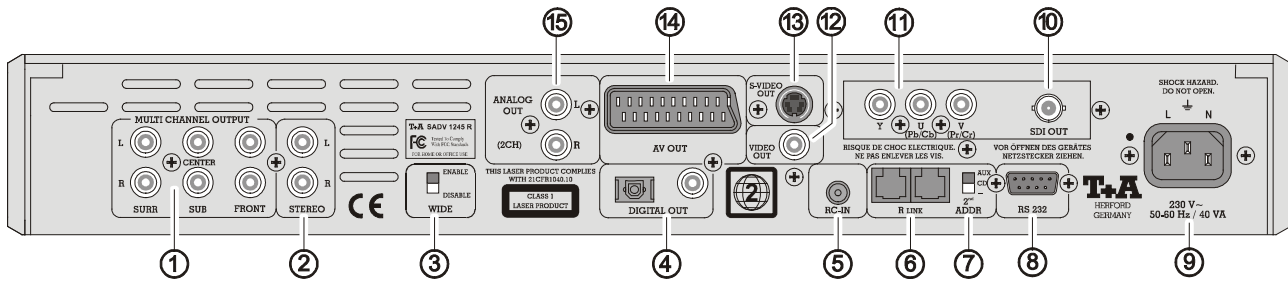

① / ② MULTI CHANNEL ANALOG OUT

The analogue output of this player delivers analogue multi channel (①) and stereo- (②) output signals. The multi channel output can be connected to surround decoders/receivers with a 5.1 or 7,1 multi channel input. The stereo output can be connected to any stereo pre-amp, integrated amp or receiver.

Note:

In a **T+A** system the MCH output is connected to the 5.1 or 7.1 MCH input of the surround decoder / surround receiver. (see **wiring diagrams 1 and 2**).

③ WIDE

Switch for the analogue high frequency output filter of the **SADV 1245 R**. With this switch the bandwidth selection (switch **'WIDE'** on the front panel) can be disabled for security reasons.

Set this switch to the position 'disabled' if your amplifier or loudspeaker system is not capable of processing audio signals above 100 kHz.

Note:

For all **T+A** amplifiers the position **'WIDE ENABLE'** can be safely used.

⚠ Attention!

If you are not sure if your system is suited for wide bandwidth operation, please consult the manual of the amplifier and speaker system. If in doubt, please use the position **'WIDE DISABLE'**.

④ DIGITAL OUT SURROUND

Optical digital output for connecting a digital surround decoder.

Co-axial digital output for connecting a digital surround decoder. Please be sure to use high-quality 75 Ω cable with Cinch connectors.

⑤ RC-IN

Input socket for external IR (infra-red) remote control receiver E2000 (* optional accessory) or external remote device such as a programmable key pad.

⑥ RLINK

Control input / output sockets for the **T+A RLINK** system:

Both sockets are wired identically - either of the two sockets can serve as input, while the other can then be used as output to the next **RLINK** device.

⑦ RLINK 2nd ADDR.

Toggle switch for the selection of the remote control address of this device within a **T+A-RLINK** system.

Note:

If no CD player is operated within the **T+A 'R'** system, the **'RLINK 2nd ADDR.'** switch of the **SADV 1245 R** should be configured to the additional CD address (position switch position = 'CD')

In this case the stereo output ② should be connected to the CD input of the pre- or integrated amplifier. The **CD** button will then select the **SADV 1245 R** for normal stereo CD play back, the DVD button will select the **SADV 1245 R** for DVD play back. The unit will respond to remote control signals for both of the CD and DVD inputs.

If a stereo CD player is present in the system, please set the switch to position '-'. The **SADV 1245 R** now will only respond to remote control signals if the input DVD is selected as source.

⑧ RS 232 connector

Control input for controlling the **SADV 1245 R** through a serial RS232 interface.

⑨ Mains input

The mains power lead is connected to this socket. For details of a correct mains connection please read the notes in the chapter '**Installation, Using the unit for the first time, Safety notes**'.

⑩ SDI OUT (Serial Digital Interface - optional)

Professional digital video interface (can be retro-fitted). The SDI connection to a video projector/monitor with SDI input guarantees a lossless video transmission even over long cable runs.

⑪ YUV video output

This video output delivers high quality YUV (P P_b P_r) output signals. Use this output to connect a video projector/monitor with YUV input.

Important Note:



The YUV output can be set to „progressive scan“ operation with the P-Scan switch on the front panel. In progressive mode full frames instead of half frames are output by the YUV output. This gives a far better picture quality. The monitor/projector used must be compatible with progressive video ! (please refer to the manual of the video monitor/projector)

⑫ VIDEO OUT

Video output for TV sets, video recorders or other equipment with standard composite (CVBS) video inputs.

⑬ S-VIDEO OUT

Output socket for TV sets, video recorders or other equipment with S-Video (S-VHS) video inputs.

⑭ AV OUT (SCART)

Socket for for TV sets, video recorders or other equipment with SCART audio/ video inputs.

This socket delivers additional to standard composite (CVBS) video signals the high quality RGB component video signals. To achieve the best possible video performance, please select the RGB mode at your TV/monitor if this device is capable of processing these signals.

⑮ ANALOG OUT

Stereo audio output for TV sets, video recorders or surround decoders.

Setting Up the SADV 1245 R

Carefully unpack the **SADV 1245 R** and store the original packing materials carefully. The carton and packing are specially designed for this unit and will be needed again if you wish to move the equipment at any time. Please be sure to read the safety notes in these instructions.

If the unit gets very cold (e. g. when being transported), condensation may form inside it. Please do not switch it on until it has had plenty of time to warm up to room temperature, so that any condensation evaporates completely.

Before placing the unit on a sensitive surface, please check the compatibility of the lacquer and the unit's feet at a non-visible point. Fit a layer of protective material if necessary.

The unit should be set up on a rigid, level base. If you are placing the unit on resonance absorbers or de-coupling components, make sure that they do not compromise its stability.

The unit should be set up in a dry, well-ventilated site, out of direct sunlight and away from radiators and other heaters. It must not be located close to heat-producing objects or devices, or anything that is heat-sensitive or highly inflammable.

The SADV player must never be set up between heat-generating devices such as integrated amplifiers (PA), power amplifiers or surround decoders (DD).

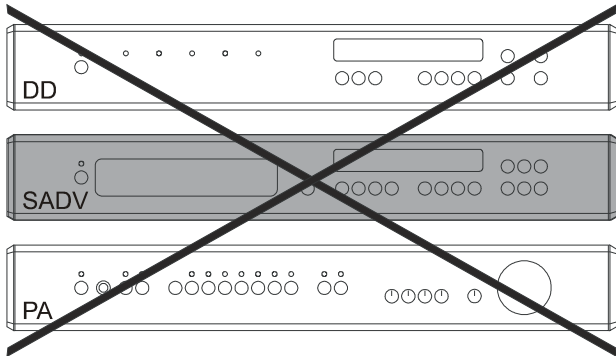

The SADV should never be placed on top of an amplifier or any other device that can become hot during operation.

Either place the device at the side of other equipment or on top of cool devices like tuners, pre-amps etc.

'R' series devices dissipate some of their heat via the case cover. For this reason units of any other make which are placed on top of a **T+A 'R'** series device must stand on feet at least 2 cm high.

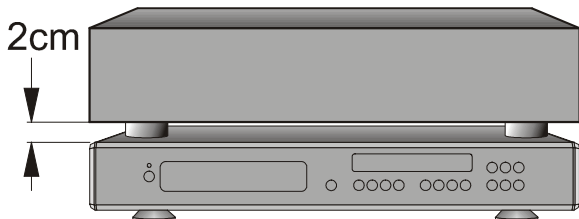

When installing the unit on a shelf or in a cupboard it is essential to provide an adequate flow of cooling air, to ensure that the heat produced by the unit is dissipated effectively. For this reason there must be at least 10 cm free space **to both sides** and **behind** the units. There should also be 10 cm **above** the case to the next cupboard or shelf.

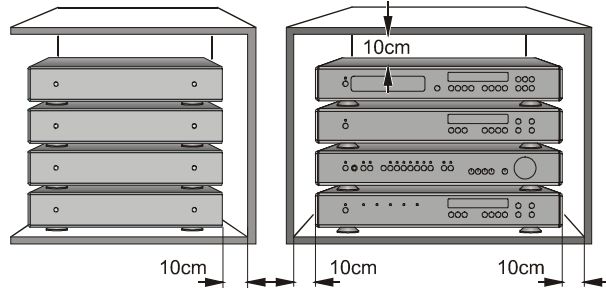

Any heat build-up will shorten the life of the DVD player, and could be a source of danger!

Mechanical de-coupling

The area on which you set up your high-quality Hi-Fi equipment, and the actual surface on which it stands, have an influence on the achievable sound quality which should not be under-estimated. The surface should be as heavy, stable, hard and flat as possible. The unit is supplied with the newly developed **T+A** conical absorber feet. These feet feature internal damping characteristics which de-couple the player extremely effectively from the base surface.

Note:

The **T+A** absorber cones can be screwed in or out to compensate exactly for any unevenness of the base surface.



The unit must be adjusted carefully so that it is exactly horizontal in all directions. All the feet must make firm contact with the base surface; the unit must not 'wobble'!

Wiring

Notes on wiring

- You will find wiring diagrams on the following pages.
- Make all connections as shown in the wiring diagrams.
- Push all connectors firmly into their sockets. Loose connections can cause humming and other unwanted noises.
- Please also make all necessary adjustments like input assignments etc. on your surround amplifier or surround receiver.
- Deploy the mains and loudspeaker cables and the **RLINK** lead as far as possible from signal interconnects and aerial leads.
- Connect the machine to a properly earthed mains socket using the mains lead supplied.
- To obtain maximum interference rejection the mains plug should be fitted in the mains socket with phase connected to the mains input socket contact which is marked with a dot (●). The phase of the mains socket can be found using a suitable instrument; ask your specialist dealer for details.

We recommend the use of the ready-made **T+A** **'POWER LINE'** mains lead in conjunction with the **'POWER BAR'** mains distribution panel; this unit features a phase indicator as standard.

Once the system is completely wired, set the volume control to a very low value and switch the player on.

The integral screen of the **SADV 1245 R** should now light up, and the player should respond to control commands.

Place an audio CD in the disc drawer, and press the **PLAY** button to start playback.

Switch the amplifier to the source device **'CD'**, switch on the loudspeaker output, and you should hear the CD.

If you encounter problems when using the player for the first time, please note that they often have simple causes that are equally simple to correct. Read the chapter entitled **'Trouble-shooting'** in these instructions.

Loudspeaker and signal cables

The cables employed in any Hi-Fi system have a crucial influence on the sound of the system as a whole. **T+A** therefore recommends the use of high-quality cables and connectors.

For this reason **T+A** has developed its own range of cables which includes the ideal type for every application. These cables are designed to match the special characteristics of our loudspeakers and harmonise perfectly with them.

For difficult and cramped set-up conditions you can also use special-length cables and right-angle connectors from the **T+A** range of accessories. With these items you can solve virtually any problem concerning connections and set-up.

Mains leads and mains filters

The mains power supply carries the essential energy to operate your equipment, but also often carries interference from distant equipment, radios and computer systems.

To shield your equipment from electro-magnetic interference, our accessory range includes the specially shielded **'POWER FOUR'** mains lead, the ready-made **'POWER LINE'** mains lead with integral wrap-around filters, and the **'POWER BAR'** filtered mains distribution panel. Using these accessories can in many cases improve the reproduction quality of our equipment.

For any questions concerning cables and wiring please contact your local **T+A** specialist dealer, who is trained to provide comprehensive and unbiased assistance. We will also be delighted to send you a full information pack on this subject.

Wiring diagram 1: SADV 1245 R and SR 1535 R with S-Video and Component YUV Video

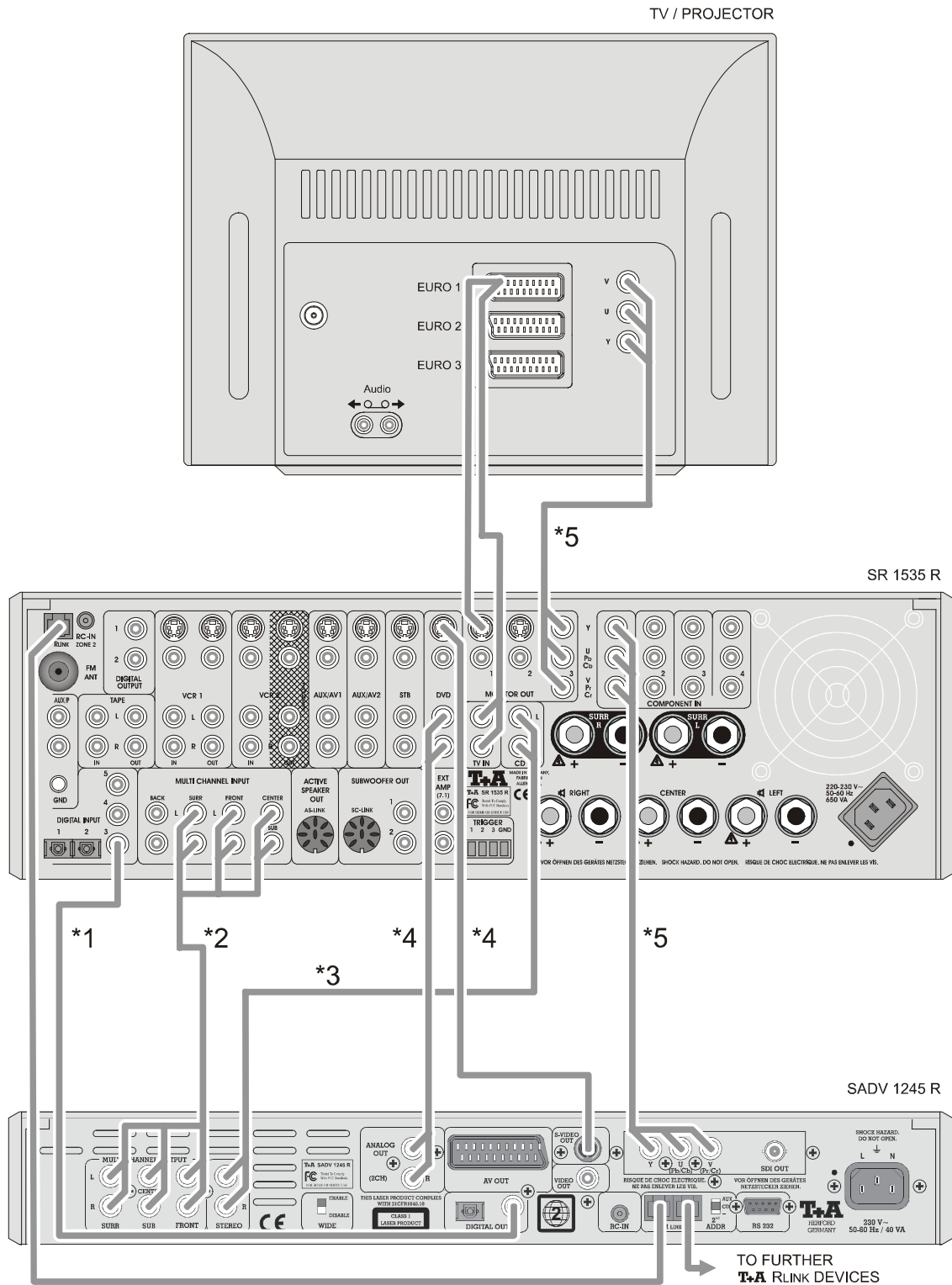

- *1 used for Dolby/dts playback through **SR 1535 R**
- *2 for multi channel SACD playback
- *3 for high-quality Stereo CD/SACD playback
- *4 S-Video+2channel audio is needed for VCR recordings and Zone 2
- *5 additional YUV-ComponentVideo-cable for Video monitors/projectors with component video input

Note:

Please make the following assignments in the configuration menus of the **SR 1535 R** :

- | | | | |
|---------------|--------------|---|---------|
| Audio Inputs: | MCH-IN | → | CD |
| | DIG-3 (coax) | → | DVD |
| YUV-Inputs: | YUV1 | → | DVD |
| Video-Inputs: | DVDin | → | S-Video |

The switch **RLINK 2nd ADDR.** on the back panel of the **SADV 1245 R** must be set to position 'CD'.

Wiring diagram 2: SADV 1245 R in combination with DD 1535 R und PA 1530 R (S-Video-mode)

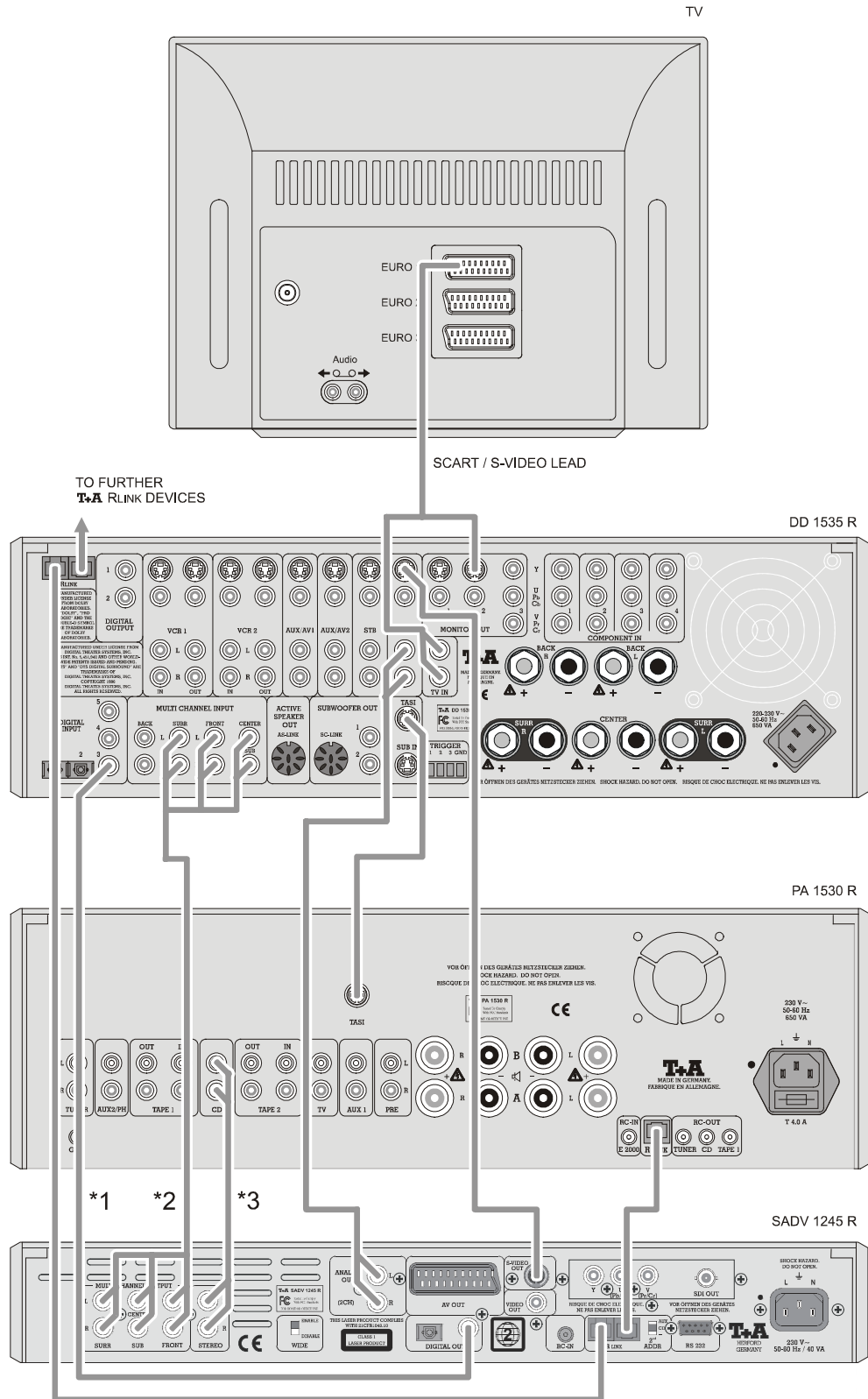

- *1 for Dolby/dts playback through DD 1535 R
- *2 for multichannel SACD playback
- *3 for high quality Stereo CD/SACD playback

Note:

Please make the following assignments in the configuration menus of the DD 1535 R:

- Audio Inputs: MCH-IN → CD
- DIG-3 (coax) → DVD
- Video-Inputs: DVDin → S-Video

The DD 1535 R should be equipped with a software version > V1.10

The switch **RLINK** 2nd ADDR. on the back panel of the SADV 1245 R must be set to position 'CD'.

If the **SADV 1245 R** is to be operated in a non-**T+A** system, the **E 2000** remote control receiver must be connected to the **RC-IN** socket if you wish to remote-control the player.

In this configuration the **SADV 1245 R** is switched ON with the **source button** **(CD/DVD)**. The switch **RLINK 2nd ADDR.** must be set to position 'CD'.

Wiring diagram 3: SADV 1245 R connected to a stereo amplifier

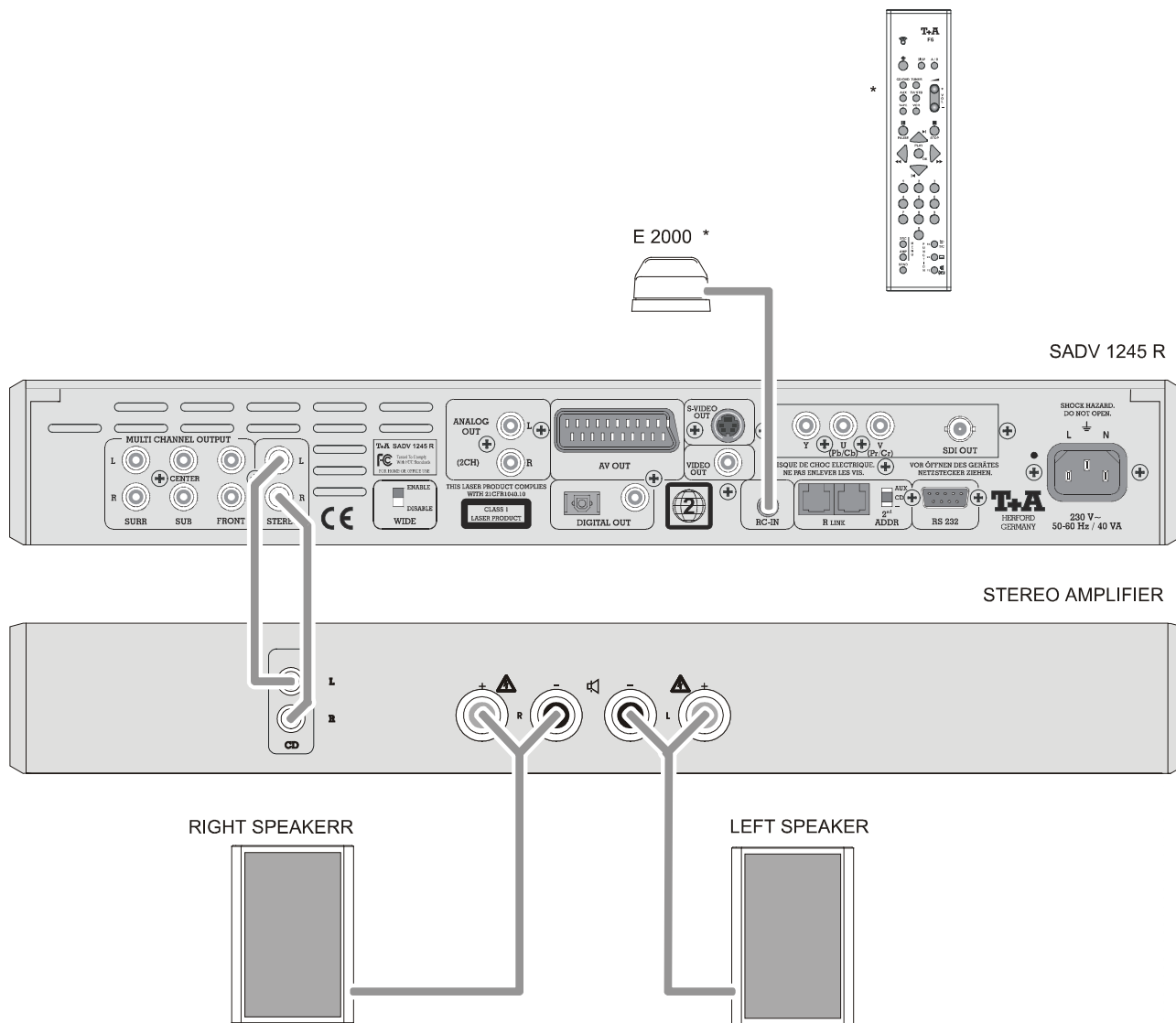

* optional accessories

When playing back multichannel SACDs switch to STEREO operation (**(AUDIO MODE)**-button on the front panel).

For DVD playback: Choose '**Stereo**' in the setup menu:

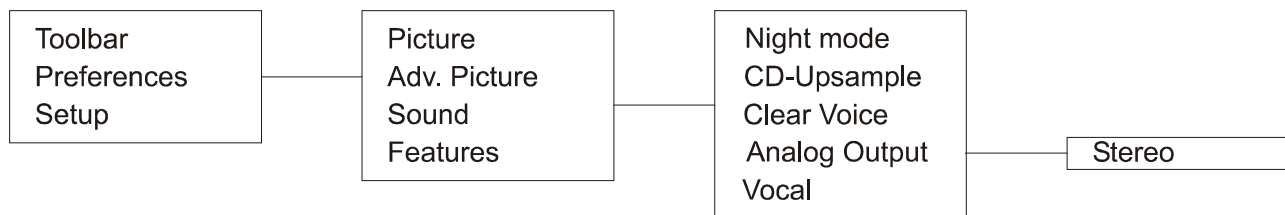

Wiring diagram 4: SADV 1245 R connected to a surround amplifier

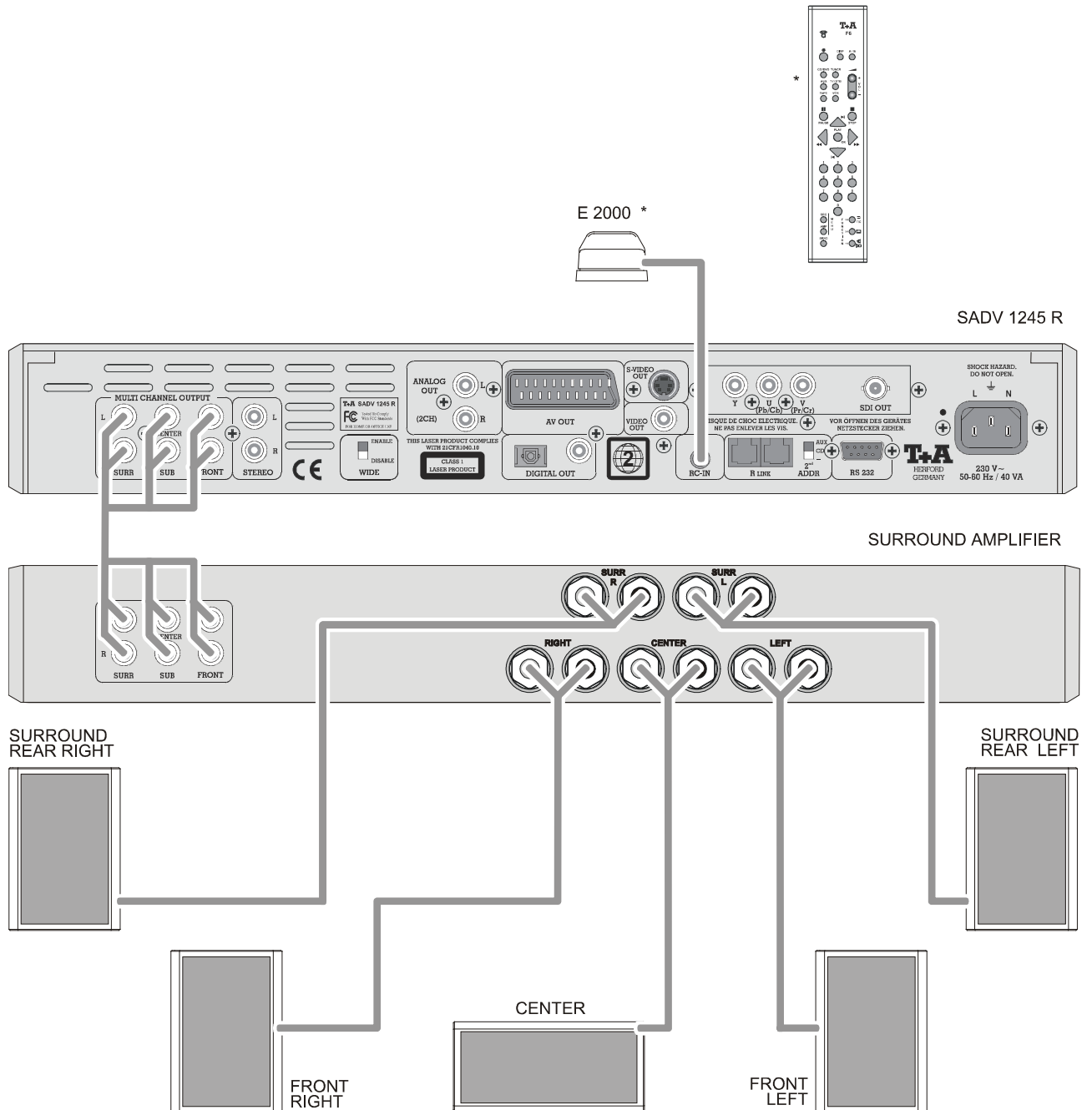

* optional accessories

Note:

Carry out the adjustments for setting speaker size, volume level and speaker distances in the menus of the SADV 1245 R.

Safety notes

All components used in this device meet the current German and European safety norms and standards. For your own safety please be sure to read right through these operating instructions. It is especially important to observe the safety notes and the instructions regarding setting up and operating the equipment.

We are able to guarantee that our products are of the highest quality, and meet all our specifications in full, because we carry out strict quality checking of all materials, employ painstaking production methods controlled by highly qualified staff, and carry out a fully automatic, computer-controlled final quality control procedure.

Please read right through these operating instructions carefully before you attempt to use your new equipment. Note in particular the information regarding setting up and operating the unit, and the safety notes.

The machine must be set up in such a way that there is no chance of anyone - especially children - touching the back panel connections. Be sure to observe the notes and instructions in the chapter entitled '**Installation, Using the unit for the first time, Safety notes**'.

The power supply required for this machine is printed on the mains supply socket. The unit must never be connected to a power supply which does not meet this specification. If the machine is not to be used for a long period, disconnect it from the mains supply at the wall socket.

Mains leads must be deployed in such a way that there is no danger of damage from furniture, or people treading on them etc. Take particular care with mains plugs, distribution panels and the connections on the back panel of the player.

Liquid or foreign bodies must never be allowed inside the case through the ventilation slots. Mains voltage is present inside the unit, and there is a risk of lethal electric shock.

Protect the unit from drips and splashes of water; never place flower vases or other vessels containing fluids on top of the case.

Do not exert undue force on the mains connectors.

Caution!

The mains button is not a mains isolation switch. Even when the green LED is not glowing, parts of the machine remain connected to the mains power supply. If the machine is not to be used for a long period, we recommend that you isolate it from the mains by pulling out the plug at the wall socket.

This device should never be used without proper supervision. The machine should be set up well out of the reach of small children. This applies to all electrical equipment.



CAUTION ! LETHAL DANGER !

The unit should only ever be opened by a qualified specialist technician.

Repairs and fuse replacements should be entrusted to an authorised **T+A** specialist workshop.

With the exception of the connections and procedures described in these instructions, no work of any kind may be carried out on the machine by unqualified persons.

If the unit is damaged, or if you suspect that it is not functioning correctly, immediately disconnect the mains plug at the wall socket, and ask an authorised **T+A** specialist workshop to check it.

The unit may be damaged by excess voltage in the power supply, the cable network or aerial systems, as may occur due to static discharge or during thunderstorms (lightning strikes).

Special power supply units and excess voltage protectors such as the **T+A 'Power Bar'** mains distribution panel offer some degree of protection from damage to equipment due to the hazards described above.

However, if you require absolute security from damage due to excess voltage, the only solution is to disconnect the unit from the mains power supply and any aerial systems.

If you believe there is a danger of excess voltage (e. g. when an electrical storm is building up) disconnect the machine from the mains and the aerial socket.

All mains power supply and aerial systems to which the unit is connected must meet the currently valid regulations, and must be installed by an approved electrical installer.

Note:

Many insurance companies offer lightning damage cover for electrical equipment as part of their general household insurance.

Approved usage

This device is designed exclusively for reproducing sound and/or pictures in the domestic environment. It must be operated in a dry indoor room which meets all the recommendations stated in these instructions.

Where the equipment is to be used for other purposes, especially in the medical field or for any purpose where safety is an issue, it is essential to establish the unit's suitability for this application with the manufacturer, and to obtain prior written approval for such usage.

T+A equipment which includes a radio or television receiving section must be operated within the regulations laid down by the Post Office and the Tele-communications authorities in the country in which it is used. This unit may only be employed to receive or reproduce those transmissions which are intended for public consumption. The reception or reproduction of other transmissions (e. g. police radio or mobile radio broadcasts) is prohibited.



The only permissible method of disposing of this product is to take it to your local collection centre for electrical waste.

Fitting new batteries:

To open the battery compartment disconnect the latch by pressing in, then lift the cover out.

Remove the old cells and fit new dry cells of the **LR 03 (MICRO)** type in the battery compartment, taking care to fit them with correct polarity. Please remember that **all the cells must be replaced** at the same time.

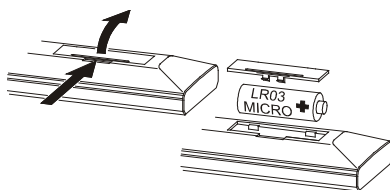

Note:

If you have already re-set the remote control system to Address 2, you will need to repeat the change procedure after fitting new batteries.

Note regarding disposal of exhausted batteries:

Exhausted batteries must not be thrown in the ordinary domestic waste! In accordance with the battery decree (**BattVO**) they should be returned to the battery supplier or to your local toxic waste collection point, so that they can be recycled or disposed of safely. Local councils are obliged to make collection containers available, or to make other arrangements for collecting exhausted batteries.

Care of the DVD player:

Always disconnect the unit from the mains supply before cleaning it.

The surfaces of the case should be wiped clean with a soft, dry cloth only.

Never use abrasive or solvent-based cleaners!

Before switching the unit on again check carefully that no short-circuits exist at the terminals, and that you have not disturbed any connections.

Device approval and conformity with EC directives

In its original condition the unit meets all currently valid German and European regulations. It is approved for use as stipulated within the EC.

By attaching the **CE** symbol to the machine, **T+A** declares its conformity with the EC directives **89/336/EEC**, amended by **91/263/EEC** and **93/68/EEC**, and **73/23/EEC**, amended by **93/68/EEC**, and the national laws based on those directives.

The original, unaltered factory serial number must be present on the outside of the unit, and must be clearly legible. The serial number is a constituent part of our conformity declaration and therefore of the official approval for operation of the device.

The serial numbers on the device and in the original **T+A** documentation supplied with it (in particular the inspection and guarantee certificates), must not be removed or modified, and must match exactly.

Infringing any of these conditions invalidates **T+A** conformity and approval, and the unit may not then be operated within the EC. Improper use of the equipment renders the user liable to penalty under current EC and national laws.

Any modifications or repairs to the unit, or any other intervention by a workshop or other third party not authorised by **T+A**, invalidates the approval and operational permit for the equipment.

Only genuine **T+A** accessories may be connected to the DVD player, or such auxiliary equipment which is itself approved, and fulfils all currently valid legal requirements.

When used in conjunction with auxiliary devices or as part of a system, this device may only be used for the purposes stated in the section entitled '**Approved usage**'.

FCC Information to the user

(for use in the United States of America only)

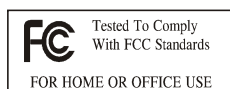

Class B digital device – instructions:

Note: This equipment has been tested and found to comply with the limits for a Class B digital device, pursuant to Part 15 of the FCC Rules. These limits are designed to provide reasonable protection against harmful interference in a residential installation. This equipment generates, uses and can radiate radio frequency energy and, if not installed and used in accordance with the instructions, may cause harmful interference to radio communications. However, there is no guarantee that interference will not occur in a particular installation. If this equipment does cause harmful interference to radio or television reception, which can be determined by turning the equipment off and on, the user is encouraged to try to correct the interference by one or more of the following measures:

- Reorient or relocate the receiving antenna.
- Increase the separation between the equipment and receiver.
- Connect the equipment into an outlet on a circuit different from that to which the receiver is connected.
- Consult the dealer or an experienced radio/TV technician for help.

Explanation of terms, useful information



DVDs can be recognised by the logo shown here.

DVDs have a very high storage capacity, and offer top-quality picture and sound reproduction.



Video CDs (VCD) can be recognised by the logo shown here. They also provide digital picture and sound information, but their lower storage capacity means that they do not quite attain the quality of DVDs.

Depending on the type of material stored on the DVD or VCD (cinema film, video clips, film trailers, information, bonus material etc.) the disc may contain one or several titles. Each title may be sub-divided into several **Chapters**. These chapters allow direct access to individual film scenes.

For historical reasons titles on a VCD are also known as **tracks**, and chapters as an **index**.

This DVD player provides simple, convenient access to any title or chapter by means of the on-screen control bar.

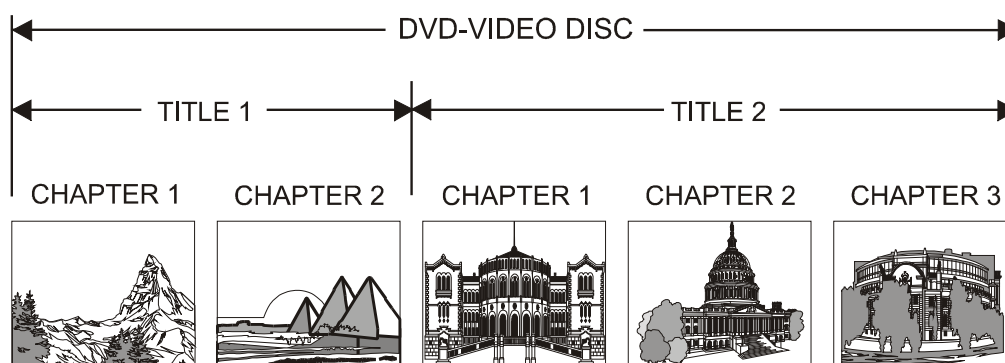

Important notes

The actual behaviour of any particular DVD is determined by the disc manufacturer. Different DVDs may vary considerably in their menu operation and running characteristics (e. g. resume, skip back to menu, end of playback at end of title etc.).

These operating instructions can only describe the basic „normal behaviour“.

If a DVD does not conform to this, please follow the DVD manufacturer's instructions, as displayed on the TV screen.

Some DVDs feature a regional code implanted by the manufacturer, designed to limit the use of these discs to particular regions of the world. The **SADV 1245 R** plays all DVDs intended for the region the unit is intended for and all DVDs which feature no regional restriction.

If you insert a DVD in the disc drawer, and see a note on the screen informing you of an incorrect regional code, please contact your DVD supplier and exchange the DVD for a version approved for your region.

CD

A Compact Disc (CD) is a digital data medium that requires a little care in handling:

- The surface of a CD may only be cleaned using a soft, dry cloth. Wipe in straight lines from the centre towards the edge.
- Never use petrol, paint thinners, disc cleaning fluids or similar agents.
- CDs must be handled with care to avoid major damage to the surface. Severely scratched surfaces, writing on the discs, or sticking labels on the discs may result in a CD that can no longer be read.
- CDs should not be heated or bent. Choose a storage site that fulfils these requirements.



DSP (Digitaler Signal Processor)

The **SADV 1245 R** features a freely programmable signal processor. A DSP can process digital signals in any way, and that is why they allow better oversampling rates than standard modules.

DVD



DVD video exploits the latest state of MPEG 2 data compression technology, which makes it possible to store an entire cinema film on a single 12 cm CD.

The variable bit rate compression of the DVD, with a read speed of up to 9.8 Mbit per second, is capable of recording even the most complex images in their original quality. The crystal-clear digital pictures have a horizontal resolution of 720 pixels (points) over more than 500 lines. This resolution is twice as high as that of the VHS system, is better than that of LaserDisc, and is directly comparable to the resolution of digital master recordings made in recording studios.

DVDs are produced to meet either the PAL or NTSC video norm. This multi-norm playback device is suitable for reproducing both types, and plays them in the best possible quality on your multi-norm TV set. Speech barriers are a thing of the past, thanks to sound tracks in up to eight languages, and sub-titles - if present on the disc - in up to 32 languages. And whether you watch DVDs on a wide-screen or conventional television, the quality will always be the same as when you originally viewed the film at the cinema.

FTS

The **FTS title select program** gives the user the opportunity to change the sequence of playback of the tracks on an audio CD. The selection is made and played using the „OSD“ menu.

Camera angle

3/7



Many DVDs and VCDs contain scenes which were recorded using different camera view angles. When such a disc is played back, the screen displays a symbol which indicates the number of available angles (e. g. 7) and the currently selected angle (e. g. 3). The **SADV 1245 R** can easily be switched to any of the different camera viewing angles.

Menu function

A DVD may contain a Disc Menu with selection facilities for individual **titles** and / or **chapters**. Depending on the DVD, the disc may also contain alternatives for camera angle, synchronous languages, sub-titles etc. The menu function of the DVD player enables you to select these options from the Disc Menu.

SHUFFLE

In Shuffle mode the tracks of a CD or the titles of an FTS program can be played back in a randomly selected order.

CD SINGLES

CD singles are discs of smaller diameter and correspondingly shorter playing time. The **SADV 1245 R** is capable of playing CD singles. To load a CD single place the disc in the circular depression in the centre of the drawer.

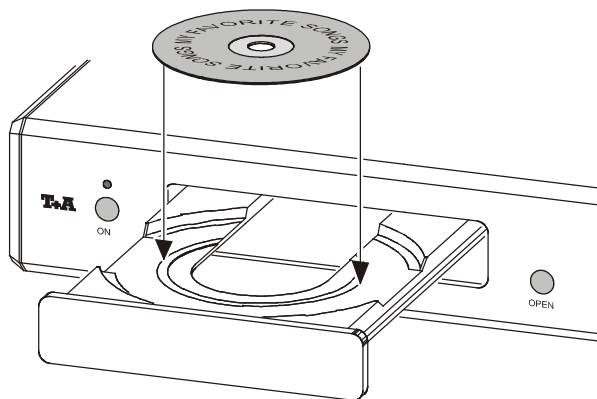

TOC

Internal index (TABLE OF CONTENT) of a CD. If the TOC area of a CD is unreadable due to damage, scratches etc., the entire CD is rendered unusable.

TRACK

Track is another termed used for a title on a CD. The tracks and their duration are stated on the CD sleeve.

Technical description

OVERSAMPLING

The audio data on CDs and DVDs is stored at a sampling rate of 44.1 or 48 kHz - i. e. for each second of music 44.100 or 48.000 sampled values are available for each channel. In the **SADV 1245 R** the audio data read from the DVD or CD is „multiplied“ to a higher sampling rate (384 kHz) before it is converted back into analogue music signals. This process delivers a significantly better, more finely graduated signal to the converter, which can then be converted with correspondingly higher precision. The raised sampling rate is a calculating process for which there are many different mathematical methods. In almost all digital audio devices which exploit the advantages of increased digital sampling rate a process known as a FIR (Finite Impulse Response) filter is employed for this purpose. At **T+A** we have been carrying out research for more than ten years, aimed at improving the oversampling process, because the standard FIR method has one drawback to set against its indisputable advantages: it adds small pre- and post-echoes to the music signals. At **T+A** we have developed mathematical processes (known as Bezier polynomial interpolators) which do not share this disadvantage. For this reason they should sound better and more natural than the usual standard process. Since the calculating procedure employed by us is considerably more complex than the standard method, the **SADV 1245 R** features a high-performance digital signal processor (DSP) which carries out the over-sampling process with immense precision (56 bit) using special algorithms developed by **T+A**.

The freely programmable DSP which we use is capable of carrying out the oversampling process using any method of calculation. For this reason we have implemented two slightly modified Bezier processes (OVS 2) in the **SADV 1245 R** in addition to the pure Bezier process (OVS 3), together with two variants of the standard process (standard OVS FIR filter and OVS 1). For more information on the different processes please refer to the next section. You can switch between the different algorithms using the FILTER button, and decide for your-self which of the filters you prefer.

Standard OVS FIR filter

The long FIR filter is the standard oversampling process in digital technology, offering extremely linear frequency response, very high damping, linear phase characteristics and constant group delays. The disadvantage is the pre- and post-echoes which are added to the signal. These „time range errors“ tend to affect the music signal's dynamics, precision and naturalness, and reduce spatial orientation.

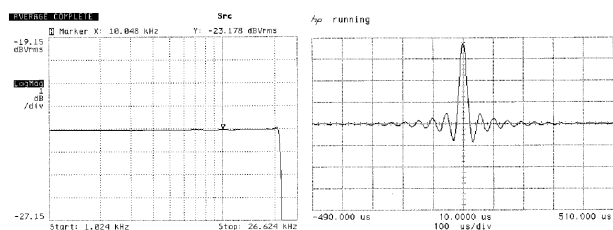

Frequency response and transient characteristics of the long FIR filter

OVS 1 (short FIR filter)

Shortening the filter (lower coefficient) reduces the time range errors, albeit combined with a slight loss of linearity in the frequency range and damping performance.

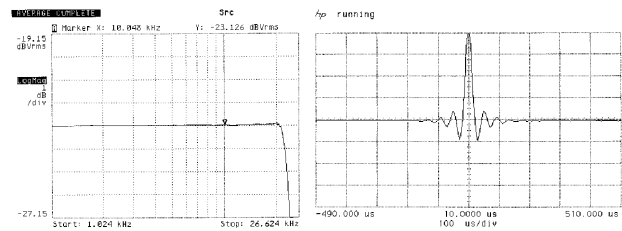

Frequency response and transient characteristics of the short FIR filter

OVS 2 (Bezier interpolator plus IIR filter)

In this process an ideal Bezier interpolator is combined with what is known as an IIR filter. This eliminates the problematic pre-echo of the FIR method. This process produces highly „analogue“ system characteristics, with a sound quality and measured performance similar to those of good analogue disc players.

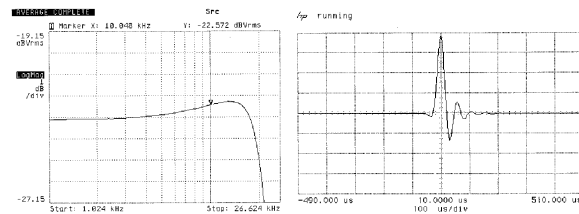

Frequency response and transient characteristics of the Bezier interpolator plus IIR filter

OVS 3 (pure Bezier interpolator)

This process delivers a perfect reconstruction of the original music signal. It exhibits no pre- or post-echoes of any kind, and does not add coloration or timing errors to the original signal. In sonic terms this method offers an impressive blend of naturalness, good dynamics and accuracy. This is our preferred process due to its advantages in respect of sound, and is the basic (default) setting of the **SADV 1245 R**.

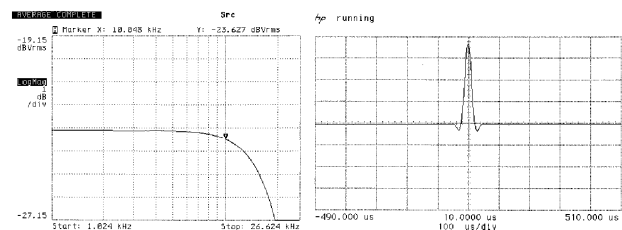

Frequency response and transient characteristics of the Bezier interpolator

Note:

For optimum performance of the **T+A** oversampling algorithms please select **CD-Upsample = OFF** in the menu **'PREFERENCES / SOUND'**. We suggest to use this setting at all times.

SACD Operation

CD/DVD and SACD discs have a totally different data structure.

For a CD or DVD recording the analogue signal is sampled at a high rate (44.100 or 48.000 samples / second). The audio signals have to be bandwidth limited before the sampling process to get rid of signal components above 20 kHz because these could not be correctly digitized.

The 20 kHz bandwidth limiting is not necessary for SACD recordings. It is thus possible to record and store audio frequencies up to 100 kHz on SACDs. However, all SACD recordings use a process call "noise shaping" to achieve a dynamic range comparable to CD/DVD systems. This noise shaping leads to a substantial amount of high frequency noise in the range 40 ...100 kHz.

There is a practical problem with the noise shaping; the high frequency noise associated with SACD recordings can not be handled by all amplifier and speaker systems. In some of these the high frequency signals contained on SACDs lead to distortion and thus degrade the sound quality. In such cases it is necessary to limit the bandwidth of the system to about 40 kHz. This would mean to sacrifice the main advantage of the SACD system.

To get the best possible performance out of your HiFi system, the **SADV 1245 R** offers analog and digital signal processing means to tailor the analog output signal exactly to the requirements of your amplifier and speakers.

These processing means consist of 4 different digital filters with different bandwidths and different stop band attenuations. (OVS standard, 1, 2, 4). Additionally you can select the 'WIDE' bandwidth mode for the analog output, if your system is capable of handling frequencies up to 400 kHz.

With the OVS and WIDE buttons on the front panel you can experiment and find the combination of oversampling and analog processing that delivers the best sonic results with your equipment.

T+A Amplifiers are very linear devices having a very wide bandwidth. So you can use all possible OVS/WIDE combinations without limitation. We recommend a wide bandwidth configuration using OVS 1 or 3 with our amps.

Standard OVS

This filter introduces a slight limitation of the high frequency bandwidth. It is suited for most amplifier / speaker systems.

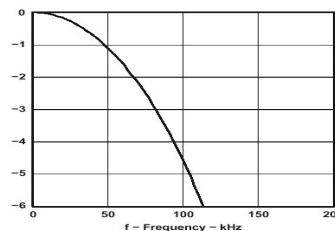

OVS 1

This filter features a wider frequency range. Good amplifiers with at least 100 kHz bandwidth are required.

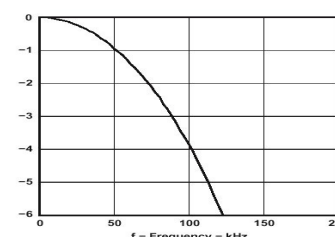

OVS 2

This filter has the narrowest bandwidth and is recommended for amplifiers with a frequency response <50 kHz.

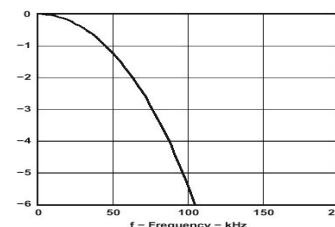

OVS 3

This filter introduces no bandwidth limitation of the audio signals. A very good amplifier / speaker combination which can handle signals above 250 kHz without problems is required.

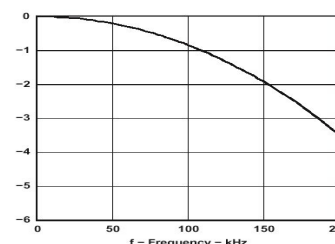

Trouble-shooting

Many problems have a simple cause and a correspondingly simple solution. The following section describes a few difficulties you may encounter, and the measures you need to take to cure them.

If you find it impossible to solve a problem with the help of these notes, please disconnect the unit from the mains and ask your authorised **T.A.** specialist dealer for advice.

Problem:	Machine does not switch on (green LED stays dark).
Cause:	Mains lead not connected correctly.
Remedy:	Check connection, push in firmly.

Problem:	Machine does not respond when buttons are pressed.
Cause:	Static discharge or powerful interference (e.g. lightning) have affected the processor's memory.
Remedy:	Reset machine: disconnect the mains plug, wait about 10 seconds, then plug in again. Switch the machine on.

Problem:	Machine responds correctly when front panel buttons are pressed, but cannot be remote-controlled via an 'R' series pre-amplifier, integrated amplifier or receiver.
Cause 1:	Batteries in remote control handset exhausted or fitted incorrectly.
Remedy:	Fit new batteries, or re-fit batteries with correct polarity.
Cause 2:	RLINK or RC plug not connected correctly to machine's RLINK or RC socket.
Remedy:	Complete connections as shown in wiring diagram; push connector in firmly.
Cause 3:	No visual contact between remote control transmitter and remote control receiver of the 'R' series pre-amplifier, integrated amplifier or receiver.
Remedy:	Ensure direct visual contact between remote control transmitter and receiver (glass doors may prevent contact). The maximum range of the remote control system is about 8 metres. Position the remote control receiver so that it is not subjected to direct sunlight or excessively bright lighting. Fluorescent lamps and energy-saving bulbs are powerful sources of interference.

Cause 4:	The DVD player is not selected as current listening source on the pre-amplifier, integrated amplifier or receiver, i.e. the control commands from the handset are being passed to another 'R' system device.
Remedy:	Press the CD (or AUX - see next point) on the remote control handset, and try again.
Cause 5:	The remote control address of the DVD player (AUX or CD) does not correspond to the selected audio input sockets on the pre-amplifier, integrated amplifier or receiver.
Remedy:	The 'RLINK 2nd ADDR.' switch on the back panel can be used to configure the DVD player either as AUX or CD . You must then select the appropriate input sockets (see 'Back panel connections').

Problem:	Loud hum from the loudspeakers.
Cause:	Cinch plugs making poor contact, or faulty Cinch lead.
Remedy:	Check all connections and connecting leads carefully.

Problem:	No sound, or distorted sound.
Cause:	Audio connection to amplifier or TV set not correct.
Remedy:	Complete the connections as shown in the wiring diagram; push connectors in firmly. Select a different listening source to check the amplifier.

Problem:	No sound signal via the digital output.
Cause 1:	Digital plug not connected correctly to the digital output socket on the machine.
Remedy:	Complete connections as per wiring diagram; push connectors in firmly.
Cause 2:	Digital output switched off.
Remedy:	Switch the digital output on using the SETUP menu.
Cause 3:	The data format of the selected audio channel (e.g. Dolby Digital or DTS) is not recognised by the decoder connected to the system.
Remedy:	Use a decoder which supports the data formats.

Problem:	Surround decoder / receiver fails to recognise digital surround programs (Dolby Digital or dts).
Cause:	The digital output of the SADV 1245 R is wrongly configured (PCM instead of ALL).
Remedy:	Set the digital output to the correct ALL setting (see ' Basic device settings ').

Problem:	Nothing displayed on the screen.
Cause:	Screen switched off.
Remedy:	Press  button to switch it on again.

Problem:	The disc will not play once the disc drawer is closed.
Cause 1:	Disc not inserted correctly.
Remedy:	Position the disc centrally: printed face up.
Cause 2:	Disc soiled.
Remedy:	Carefully clean the disc by wiping with a soft cloth from the centre to the edge. Replace the disc and try again.
Cause 3:	Disc damaged in the area of the Table of Contents (TOC). Disc unusable.
Remedy:	No remedy possible.
Cause 4:	Machine has got very cold (e. g. after transport), allowing condensation to form on the laser sensor optics.
Remedy:	Leave the machine to warm up for about an hour in a warm, well ventilated place.

Problem:	Disc stops playing, or 'skips'.
Cause:	Disc dirty or damaged.
Remedy:	Clean disc. Damage cannot be repaired!

Problem:	Black and white picture, distortion or scrolling when playing a DVD or VCD.
Cause:	The television is not set to the same picture name (PAL / NTSC) as the disc, or cannot process its picture norm.
Remedy 1:	chose PAL/NTSC according to your TV set in the menu ' Preferences '
Remedy 2:	Use a multi-norm TV set. These sets automatically switch to the current picture norm, or can be switched over manually

Problem:	After removing the disc the machine fails to return to the Start screen.
Cause:	The program may be waiting for a further disc.
Remedy:	Insert the next disc.

Problem:	The picture is displayed too small or incompletely (abbreviated).
Cause 1:	The DVD in the drawer is not set to the same picture format (4 : 3 or 16 : 9) as the TV set connected to the system.
Remedy:	Set the correct picture format in the SETUP menu.
Cause 2:	Many DVDs contain film recordings in different picture formats on the front and rear faces.
Remedy:	Turn the DVD over, or set the correct picture format in the SETUP menu.
Cause 3:	The television is set to the wrong picture format.
Remedy:	Set the TV to the correct picture format, i. e. the one corresponding to the DVD.

Problem:	The SADV 1245 R fails to carry out certain functions.
Cause 1:	Function blocked for this DVD.
Cause 2:	Function (e. g. camera angle, sub-titles etc.) not present on this DVD.
Remedy:	No remedy possible.

Problem:	After inserting a DVD the screen displays a warning of the wrong regional code.
Cause:	The DVD is not approved for your region.
Remedy:	Contact your DVD supplier and exchange the disc for a version approved for your region.

Problem:	In rare cases the DVD's Disc Menu cannot be operated when the 'Pan-Scan' picture format is set.
Remedy:	Set picture format to "Letterbox"; call up the Disc Menu again.

Problem:	If the SADV 1245 R is connected to a TV set directly using a SCART lead, this can result in a scrolling DVD picture appearing on all programme memories. This problem may occur with many types of TV.
Cause:	The TV set is analysing the A/V switching signal from the DVD player incorrectly, or not at all.
Remedy 1:	If possible, call up the Setup menu for your TV set and switch off RGB priority. Select the RGB signal type for the DVD SCART input of your TV set.
Remedy 2:	If your television does not provide this option, connect the DVD player using an S-VHS lead, or use a SCART lead without RGB signal. Ask your T+A dealer for help with this.
Remedy 3:	When watching TV, switch off the DVD player by pressing the ON button on the front panel.

Problem:	When used in a non- T+A system the machine does not respond to remote control commands, or cannot be switched on by remote control.
Cause:	E 2000 remote control receiver not connected.
Remedy:	Connect the E 2000 remote control receiver as shown in Wiring Diagram 3 . Press the source select button (CD) (or AUX) on the remote control handset to switch the machine on.

Problem:	When operating the menu for the surround decoder or surround receiver, the SADV 1245 R also responds.
Cause:	E 2000 connected to the SADV 1245 R .
Remedy:	Connect the E 2000 to the pre-amplifier, integrated amplifier or receiver.

Problem:	MP3 CD does not play back.
Cause:	MP3 format not supported (see ' Playing MP3 CDs ').
Remedy:	(see ' Playing MP3 CDs ')

Problem:	Distorted or double picture at the YUV output
Cause:	P-Scan switched on buit TV set not compatible with progressive video signals
Remedy:	Switch P-Scan off (P-SCAN button on the front panel).

Problem:	No picture.
Cause:	Video-output switched off
Remedy:	switch ON the video output (VIDEO OFF button on the front panel)

Problem:	Bad or distorted sound reproduction
Cause 1:	Multi channel mode is selected but only a stereo amplifier is connected
Remedy:	switch to STEREO in the menu ' Preference / Sound / Analog output '
Cause 2:	a multi channel amplifier is used but it is switched to STEREO operation mode
Remedy:	switch the surround-amplifier to multi channel mode

Problem:	'OVERHEAT' displayed, playback stopped
Cause:	Device is over heated, too little flow of cooling air
Remedy:	change the installation of your system to provide sufficient cooling. do not place the SADV 1245 R on top of hot equipment like amplifiers or surround receivers

Problem:	Not possible to switch to MCH mode
Cause:	Disc does not contain a multi channel layer
Remedy:	no remedy, disc can only be played back in Stereo.

Problem:	The 'WIDE'-mode can not be selected
Cause:	switch ' WIDE ' at the back panel is set position ' Disable '.
Remedy:	Set switch to position ' Enable '.

Problem:	Discs can not be played. A message to enter a PIN appears.
Cause:	This disc is locked
Remedy:	Enter a valid PIN number or unlock the disc (see menu ' Setup / Access ').
Note:	In case you have forgotten your PIN number, enter the menu ' Setup / Access / Enter PIN '. Enter the input box on the right and press the STOP -button four times (the on screen display will show the "forbidden" icon). Then enter 0000 twice. The PIN is now reset to to 0000.

Specification

Mechanism:	high precision linear tracking drive GaAlAs semiconductor laser: 785 nm / 10 mW (VCD / CD) 650 nm / 7 mW (DVD / SACD)
Formats	
Video	DVD, DVD+R / +RW, DVD-R / -RW, VCD, SVCD
Audio	CD, CD-R / RW, MP3-CD, SACD Stereo + Multi channel
Picture	Picture CD (JPEG)
Audio section	
Analogue audio outputs	2 x Stereo, 6 x Multi channel, 2 x Stereo TV
Digital audio outputs	1 x coaxial, 1 optical, IEC 60958 (CDDA / LPCM), IEC 61937 (MPEG1/2, Dolby Digital, dts)
D / A converter for CD, DVD, (S)VCD, MP3 front channels (MCH analog OUT) Stereo channels L/R Surround channels / Center / Subwoofer Downmix (TV)	Double-Mono Differential 2x24 Bit / 384 kHz Sigma / Delta converter 4 x 24 Bit / 384 kHz Sigma / Delta 2 x 24 Bit / 384 kHz Sigma / Delta
D / A converter for SACD front channels surround channels	Double-Mono DSD differential converter DSD-differential converter
Frequency response:	CD 2 Hz – 20 kHz SACD normal 2 Hz – 60 kHz SACD wide 2 Hz – 120 kHz DVD-V 2 Hz - 22 kHz DVD 96/24 2 Hz - 44 kHz
Total harmonic distortion / Intermodulation:	< 0.001 %
Effective system dynamics CD / SACD:	100 dB / 110 dB
Signal / noise ratio:	115 dB
Channel separation:	110 dB
Video section	
TV-Standard:	
lines:	625 (PAL, 50 Hz) / 525 (NTSC, 60 Hz)
Progressive Scan	576 P, 480 P (Component)
Video-Format: MPEG 1 für VCD / MPEG 2 für DVD	
DVD:	
resolution horizontal / vertical:	720 Pixel / 576 lines (50 Hz) / 480 lines (60 Hz)
VCD:	
resolution horizontal / vertical:	352 Pixel / 288 lines (50 Hz) / 240 lines (60 Hz)
Video DA Converter 12-bit / 216 MHz	
Bandwidth 12.5 MHz (Luma), 6 MHz (Chroma)	
Video-Output: 1.0 V _{SS} / 75 Ω	
S-Video Output:	(Y) 1.0 V _{SS} / 75 Ω (C) 300 mV _{SS} (Burst) / 75 Ω
RGB (SCART-Output): 0.7 V _{SS} / 75 Ω	
Analogue-Audio-Output: 1.9 V _{eff} / 450 Ω	
General	
Power supply:	230 V / 50 Hz, 40 VA oder / or 117 V / 60 Hz, 40 VA (see print on back panel)
standard accessories:	power cable, RLINK-cable, Video-cable, Stereo cable User manual

We reserve the right to introduce technically founded modifications.

T+A elektroakustik GmbH & Co. KG

Herford * Germany

Free Manuals Download Website

<http://myh66.com>

<http://usermanuals.us>

<http://www.somanuals.com>

<http://www.4manuals.cc>

<http://www.manual-lib.com>

<http://www.404manual.com>

<http://www.luxmanual.com>

<http://aubethermostatmanual.com>

Golf course search by state

<http://golfingnear.com>

Email search by domain

<http://emailbydomain.com>

Auto manuals search

<http://auto.somanuals.com>

TV manuals search

<http://tv.somanuals.com>