

TAMRON®

SP 10-24mm F/3.5-4.5

Di II LD Aspherical [IF] (Model B001)

Thank you for purchasing the Tamron lens as the latest addition to your photographic equipment. Before using your new lens, please read the contents of this Owner's Manual thoroughly to familiarize yourself with your lens and the proper photographing techniques for creating the highest quality images possible. With proper handling and care, your Tamron lens will give you many years of photographing beautiful and exciting pictures.

NOMENCLATURE

1. Lens hood
2. Hood attaching alignment mark
3. Hood attached indicator
4. Filter ring
5. Hood attaching bayonet ring
6. Distance index
7. Distance scale
8. Focusing ring
9. Zooming ring
10. Focal length scale
11. Zoom index mark
12. AF/MF switch
13. Lens attachment mark
14. Lens mount/Lens mount contacts

	B001
Focal Length	10-24mm
Maximum Aperture	F/3.5-4.5
Angle of View	108 44'-60 20'
Lens Construction	9/12
Minimum Focus Distance	0.24m
Maximum Magnification Ratio of Shooting	1:5.13
Filter Size	77mm
Length	86.5mm
Diameter	83.2mm
Weight	400g
Hood	AB001

1

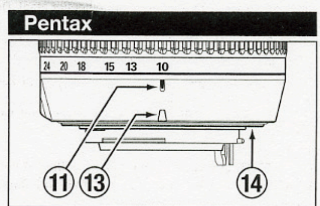
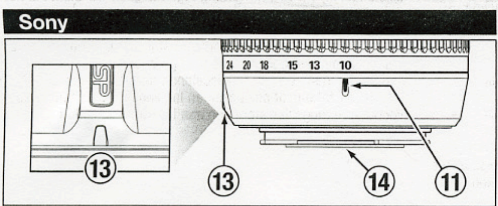
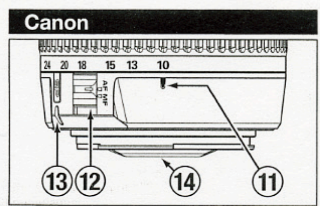
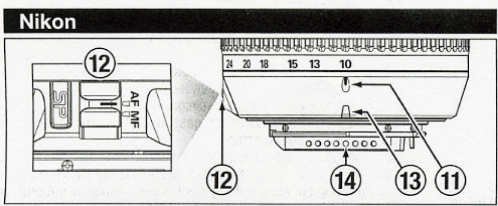
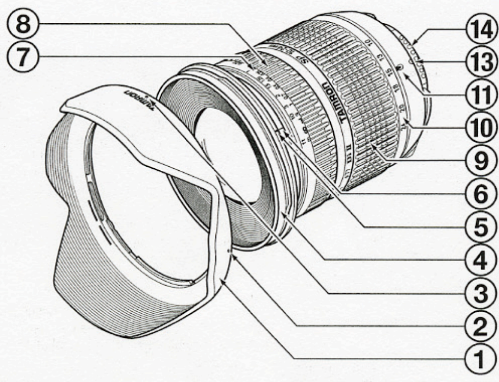

2

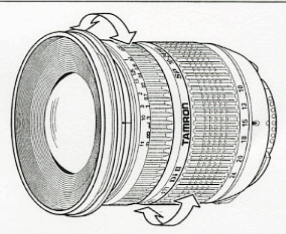

3 AF: ON

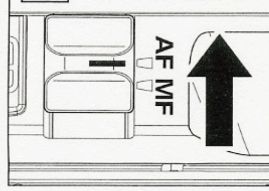

4 MF: ON

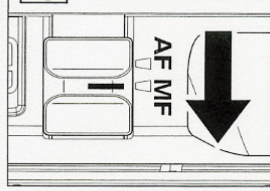

5

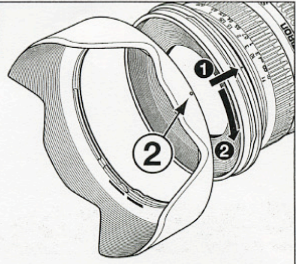

6

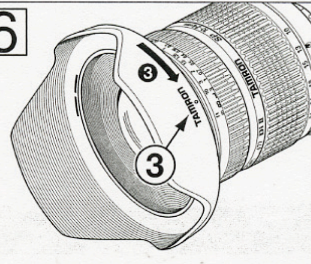

7

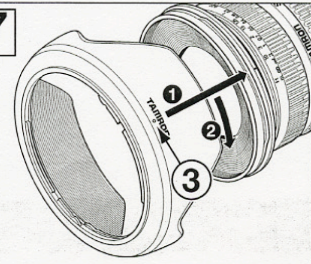

ATTACHING AND REMOVING THE LENS

** How to mount the lens*

Remove the rear cap of the lens. Align the lens attachment mark on the lens barrel with its counterpart on the camera mount and insert the lens. Rotate the lens clockwise (in case of Nikon lens, counter-clockwise) until it click-locks.

** How to detach the lens*

Pressing the lens release button on the camera down, turn the lens counter-clockwise (in case of Nikon lens, clockwise), and lift the lens off the camera's lens mount.

*The image circles of Di-II lenses are designed to match the digital SLR cameras using the image sensors equivalent to APS-C (approx. 15.5x23.2mm). Do not use Di-II lenses with cameras using image sensors larger than APS-C. Using Di-II lenses with such cameras may cause vignetting on the image.

*Some Canon cameras have index marks for attaching both EF lenses (red circle) and EF-S lenses (white square). To attach or remove Di-II lenses, align the lens attachment mark on the lens with the index mark for EF lenses (red circle). Do not forcibly align the lens attachment mark with the index mark for EF-S lens (white square). Doing so could result in damage to the lens and/or camera.

*For further details, please read the instruction manual of your camera.

FOCUSING (AUTOFOCUS)

In case of Sony or Pentax, switch the focusing mode switch of the camera to Auto focusing mode (AF). In case of a Nikon or Canon camera, switch the AF/MF switch on the lens to AF. In case of Nikon camera with the focus mode selector dial, set the focus mode to "S" or "C", and then set the AF/MF switch on the lens side to "AF". Press the shutter button lightly while viewing through the camera's viewfinder, the lens focuses automatically. An in-focus mark will light when lens focuses on the main subject sharply. Press the shutter button further to photograph.

*When set on AF mode, interfering with the focusing ring may cause serious damage to the lens mechanism.

*The distance scale is marked for guidance purposes. The actual point may slightly differ from the distance marked on the focal length index.

*For further details, please read the instruction manual of your camera.

FOCUSING (MANUAL FOCUS)

In case of Sony or Pentax, switch the focusing ring mode switch of the camera to manual focusing mode (MF). In case of a Nikon or Canon camera, switch the AF/MF switch on the lens to MF. (Fig 4). In case of Nikon camera with the focus mode selector dial, set the focus mode to "M", and then set the AF/MF switch on the lens side to "MF". Focus by

manually rotating the focusing ring while viewing through the camera's viewfinder. The main subject in the viewfinder will be sharp when the lens is focused correctly.

*Even in the MF mode while turning the focusing ring while pressing the shutter button halfway, the focus aid function lamp lights up when the picture is in focus.

*At infinity, make sure the image in the viewfinder appears sharp. The infinity position on the B001 is made with certain allowances to insure proper focus under a variety of conditions.

*For further details, please read the instruction manual of your camera.

ZOOMING

Rotate the zooming ring of the lens while viewing through the camera's viewfinder and compose your image at the chosen focal length.

LENS APERTURE AND AE MODE

Please follow the instruction manual of your camera.

LENS HOOD

A bayonet-type lens hood is provided as standard equipment. We recommend shooting with the hood attached whenever possible as the lens hood eliminates stray light which is harmful to the picture. However, please be aware of the "PRECAUTIONS IN SHOOTING" when your camera is equipped with a built-in-flash.

Attaching the Lens Hood (Fig 5 & 6)

Align the hood attaching alignment mark (2) on the hood with the corresponding hood attaching bayonet ring (5) (or the top of the index line of the distance scale) on the lens. Press the hood lightly onto the hood attaching bayonet ring and then rotate it clockwise to secure. The lens hood will be securely held as the mark "TAMRON O" comes to the top.

*Pay particular attention to align the hood attaching indexes when using zoom lenses including wide-angle (ex: 35mm or wider) settings. Improper attachment of a hood for wide-angle zoom lenses may cause large shadowed areas in your pictures.

Stowing the Lens Hood on the Lens (Fig 7)

Reverse the lens hood. Point the lens toward the opening, then align the hood attachment mark on the lens with the "TAMRON O" alignment on the hood.

Turn the hood clockwise until the alignment mark is at the top to set it. (Fig 7)

PRECAUTIONS IN SHOOTING

-The optical design for Di-II takes into consideration the various features of digital single reflex cameras. However, due to the configuration of the digital single reflex cameras, even when the auto focus accuracy is within specifications, the focal point may be a little forward or behind the optimum point when shooting with auto focus under some conditions.

-When photographing near the minimum focusing distance it is advisable to shoot at higher f-numbers to obtain sharper image quality.

-The image circles of Di-II lenses are designed to match the digital SLR camera using the image sensors equivalent to APS-C (approx. 15.5 x 23.2mm). Do not use Di-II lenses with cameras using image sensors larger than APS-C. Using Di-II lenses with such cameras may cause vignetting on the image.

-(B001) employ an internal focusing (IF) system. Because of the characteristics of this optical design, the angles of view at distances other than infinity are wider than that of the lenses applying an ordinary focusing system.

-When the built-in-flash on the camera is used, adverse photographic phenomena such as corner illumination fall-off or vignetting at the bottom part of the image may be observed, especially in wide-angle ranges. This is due to the inherent limitation of the coverage of the built-in-flash, and/or the relative position of the flash to the edge of the lens barrel which causes shadows on the image. It is strongly recommended to use a suitable separate flash unit provided by the camera manufacturer for all flash photography. For further details, please read the "built-in-flash" article on the instruction manual of your camera.

-The use of teleconverters is not recommended due to the optical performance of the lens.

-When using the lens in the telephoto focal range, please be careful with the camera shake. Effective way to avoid the camera shake is using an ISO setting of higher numbers. Using a tripod is also effective.

-When set on AF mode, interfering with the focusing ring may cause serious damage to the lens mechanism.

-Certain camera models may indicate the maximum and minimum aperture values of the lens appropriate numbers. This is inherent to the design of the camera and not an indication of error.

-When using a special filter such as a PL filter, use low profile filters. The thick rim of a normal filter may cause vignetting.

TO ENSURE LONG TERM SATISFACTION

-Avoid touching the glass element surface. Use photographic lens cloths or blowers to remove dust from the lens element surface. When not using the lens, always place a lens cap on it for protection.

-Use a lens cleaning tissue or lint cloth with a drop of cleaning solution to remove fingerprints or dirt on the glass lens surface with a rotary motion from the center to the edge. Use a silicone cloth to clean your lens barrel only.

-Mildew is an enemy of your lens. Clean the lens after shooting near water or in any humid place. Store your lens in a clean, cool, dry place. When storing the lens in a lens case, store it with commercially available drying agents such as silicagel, and change the agent occasionally. If you find mildew on your lens, consult an authorized repair shop or nearby photographic store.

-Do not touch the lens-camera interface contacts since dust, dirt and/or stains may cause a contact failure between the lens and camera.

-When using your equipment [camera(s) and lens(es)] in an environment where the temperature changes from one extreme to the other, make sure to put your equipment temporarily in a case or plastic bag for a length of time in order for the equipment to go through a gradual temperature shift. This will reduce potential equipment trouble.

Free Manuals Download Website

<http://myh66.com>

<http://usermanuals.us>

<http://www.somanuals.com>

<http://www.4manuals.cc>

<http://www.manual-lib.com>

<http://www.404manual.com>

<http://www.luxmanual.com>

<http://aubethermostatmanual.com>

Golf course search by state

<http://golfingnear.com>

Email search by domain

<http://emailbydomain.com>

Auto manuals search

<http://auto.somanuals.com>

TV manuals search

<http://tv.somanuals.com>