

Thank you for purchasing a Sony Ericsson Z555a.  
Discover gesture control. Show it off.

For additional phone content, go to  
[www.sonyericsson.com/fun](http://www.sonyericsson.com/fun).

Register now to get a suite of tools, free online  
storage, special offers, news and competitions  
at [www.sonyericsson.com/myphone](http://www.sonyericsson.com/myphone).

For product support, go to [www.sonyericsson.com/support](http://www.sonyericsson.com/support).

# Accessories – More for your Phone

## Bluetooth™ Car Speakerphone HCB-105

A portable handsfree solution for use  
in the car



## Bluetooth Headset HBH-PV770

A lightweight headset with high  
performance



## Design Collection IDC-22

Phone case in soft leather with  
integrated mirror



These accessories can be purchased separately but  
may not be available in every market. To view the  
full range go to [www.sonyericsson.com/accessories](http://www.sonyericsson.com/accessories).

# Contents

<b>Getting Started .....</b>	<b>5</b>	Voicemail .....	23
Assembly .....	5	Forwarding Calls .....	23
Turning on the Phone .....	6	More than One Call .....	24
Making and Receiving Calls .....	7	Conference Calls .....	25
Help in your Phone .....	7	My Numbers .....	25
Charging the Battery .....	8	Accept Calls .....	25
Phone Overview .....	9	Restricted Dialing .....	26
Menu Overview .....	11	Fixed Dialing .....	26
Navigation .....	13	Call Time and Cost .....	26
Shortcuts .....	14	Business Cards .....	27
Activity Menu .....	15	<b>Messaging .....</b>	<b>27</b>
File Manager .....	15	Text Messages .....	27
Phone Language .....	17	Picture Messages .....	29
Entering Text .....	18	Templates .....	30
<b>Calling .....</b>	<b>19</b>	Voice Messages .....	31
Making and Receiving Calls .....	19	Email .....	31
Emergency Calls .....	19	My Friends .....	34
Contacts .....	20	Area and Cell Information .....	35
Groups .....	22	<b>Imaging .....</b>	<b>36</b>
Call List .....	22	Camera .....	36
Speed Dial .....	23	Transferring Pictures .....	37
		Pictures .....	38

<b>Entertainment .....</b>	<b>39</b>	Tasks .....	55
Stereo Portable Handsfree .....	39	Notes .....	55
Transferring Music from a Computer .....	39	Timer, Stopwatch and Calculator .....	56
Radio .....	40	Code Memo .....	56
PlayNow™ .....	40	Profiles .....	57
Ringtones and Melodies .....	41	Time and Date .....	58
MusicDJ™ .....	42	Themes .....	58
Sound Recorder .....	42	Locks .....	58
Video Player .....	43	IMEI Number .....	59
Games .....	43	<b>Troubleshooting .....</b>	<b>60</b>
Applications .....	43	Common Questions .....	60
<b>Connectivity .....</b>	<b>44</b>	Error Messages .....	61
Settings .....	44	<b>Important Information .....</b>	<b>63</b>
Using Internet .....	44	Guidelines for Safe and Efficient Use .....	65
RSS Reader .....	46	Limited Warranty .....	69
Bluetooth™ Wireless Technology .....	46	Declaration of Conformity for Z555a .....	72
Using the USB Cable .....	49	<b>Index .....</b>	<b>73</b>
PC Suite .....	50		
Synchronizing .....	50		
Update Service .....	51		
<b>More Features .....</b>	<b>52</b>		
Gesture Control .....	52		
Alarms .....	53		
Calendar .....	53		

## Sony Ericsson Z555a

GSM 850/1800/1900

This User guide is published by Sony Ericsson Mobile Communications AB or its local affiliated company, without any warranty. Improvements and changes to this User guide necessitated by typographical errors, inaccuracies of current information, or improvements to programs and/or equipment, may be made by Sony Ericsson Mobile Communications AB or its local affiliated company at any time and without notice. Such changes will, however, be incorporated into new editions of this User guide.

All rights reserved.

©Sony Ericsson Mobile Communications AB, 2008

Publication number: 1205-9962.3

Please note:

Some of the services in this User guide are not supported by all networks. *This also applies to the GSM International Emergency Number 112.*

Please contact your network operator or service provider if you are in doubt whether you can use a particular service or not.

Please read the *Guidelines for safe and efficient use* and the *Limited warranty* chapters before you use your phone.

Your phone has the capability to download, store and forward additional content, for example ringtones. The use of such content may be restricted or prohibited by rights of third parties, including but not limited to restriction under applicable copyright laws. You, and not Sony Ericsson, are entirely responsible for additional content that you download to or forward from your phone. Prior to your use of any additional content, please verify that your intended use is properly licensed or is otherwise authorized. Sony Ericsson does not guarantee the accuracy, integrity or quality of any additional content or any other third party content. Under

no circumstances will Sony Ericsson be liable in any way for your improper use of additional content or other third party content.

Bluetooth is a trademark or registered trademark of Bluetooth SIG Inc. and any use of such mark by Sony Ericsson is under license.

The Liquid Identity logo, PlayNow and MusicDJ are trademarks or registered trademarks of Sony Ericsson Mobile Communications AB.

Sony, Memory Stick Micro and M2 are trademarks or registered trademarks of Sony Corporation.

Ericsson is a trademark or registered trademark of Telefonaktiebolaget LM Ericsson.

Adobe and Photoshop are trademarks or registered trademarks of Adobe Systems Incorporated in the United States and/or other countries.

Microsoft, Windows, Outlook and Vista are trademarks or registered trademarks of Microsoft Corporation in the United States and/or other countries.

T9™ Text Input is a trademark or a registered trademark of Tegic Communications. T9™ Text Input is licensed under one or more of the following: U.S. Pat. Nos. 5,818,437, 5,953,541, 5,187,480, 5,945,928, and 6,011,554; Canadian Pat. No. 1,331,057, United Kingdom Pat. No. 2238414B; Hong Kong Standard Pat. No. HK0940329; Republic of Singapore Pat. No. 51383; Euro.Pat. No. 0 842 463(96927260.8) DE/DK, FI, FR, IT, NL, PT, ES, SE, GB; and additional patents are pending worldwide. Java and all Java based trademarks and logos are trademarks or registered trademarks of Sun Microsystems, Inc. in the U.S. and other countries. End-user license agreement for Sun™ Java™ J2ME™.

Restrictions: Software is confidential copyrighted information of Sun and title to all copies is retained by Sun and/or its licensors. Customer shall not modify, decompile, disassemble, decrypt, extract, or otherwise reverse engineer Software. Software may not be leased, assigned, or sublicensed, in whole or in part.

Export Regulations: Software, including technical data, is subject to U.S. export control laws, including the U.S. Export Administration Act and its associated regulations, and may be subject to export or import regulations in other countries. Customer agrees to comply strictly with all such regulations and acknowledges that it has the responsibility to obtain licenses to export, re-export, or import Software. Software may not be downloaded, or otherwise exported or re-exported (i) into, or to a national or resident of, Cuba, Iraq, Iran, North Korea, Libya, Sudan, Syria (as such listing may be revised from time to time) or any country to which the U.S. has embargoed goods; or (ii) to anyone on the U.S. Treasury Department's list of Specially Designated Nations or the U.S. Commerce Department's Table of Denial Orders. Restricted Rights: Use, duplication or disclosure by the United States government is subject to the restrictions as set forth in the Rights in Technical Data and Computer Software Clauses in DFARS 252.227-7013(c) (1) (ii) and FAR 52.227-19(c) (2) as applicable.

Other product and company names mentioned herein may be the trademarks of their respective owners.

Any rights not expressly granted herein are reserved. All illustrations are for illustration only and may not accurately depict the actual phone.

## Instruction Symbols

The following appear in the User guide.



Note



Tip



Warning



A service or function is network- or subscription-dependent. Contact your network operator for details.



Use a selection or navigation key to scroll and select. See *Navigation* on page 13.



Press the navigation key center.



Press the navigation key up.



Press the navigation key down.



Press the navigation key left.



Press the navigation key right.

# Getting Started

## Assembly

Before you start using your phone, you need to insert a SIM card and the battery.

### To insert the SIM card



- 1 Remove the battery cover.
- 2 Slide the SIM card into its holder with the contacts facing down.

### To insert the battery



- 1 Insert the battery with the label side up and the connectors facing each other.
- 2 Replace the battery cover.

## Turning on the Phone

### To turn on the phone



- 1 Press and hold down **(I)**.
- 2 Enter your SIM card PIN, if requested.
- 3 Select a language.
- 4 Select **Yes** to use the setup wizard.

**!** *If you make a mistake when you enter your PIN, you can press **(C)** to delete numbers from the screen.*

### SIM card

The SIM (Subscriber Identity Module) card, which you get from your network operator, contains information about your subscription. Always turn off your phone and detach the charger before you insert or remove the SIM card.

**!** *You can save contacts on the SIM card before you remove it from your phone. See *To copy names and numbers to the SIM card* on page 21.*

### PIN

You may need a PIN (Personal Identification Number) to activate the services in your phone. Your PIN is supplied by your network operator. Each PIN digit appears as \*, unless it starts with emergency number digits, for example, 112 or 911. You can see and call an emergency number without entering a PIN.

### To delete numbers from the display

- Press **(C)**.

**!** *If you enter the wrong PIN three times in a row, **PIN Blocked** appears. To unblock it, you need to enter your PUK (Personal Unblocking Key). See *SIM card lock* on page 58.*



### Startup screen

The startup screen appears when you turn your phone on. See *Using pictures* on page 38.



## Standby

After you have turned your phone on and entered your PIN, the name of the network operator appears on the screen. This is called standby.

## Making and Receiving Calls

You must turn on your phone and be within range of a network.

### *To make a call*

- 1 From standby enter a phone number (with international country code and area code, if applicable).
- 2 Select Call.

### *To answer a call*

- Select Answer.

### *To reject a call*

- Select Busy.

## Help in your Phone

Help and information is available in your phone at any time. See *Navigation* on page 13.

### *To use the setup wizard*

- 1 From standby select **Menu > Settings > the General tab > Setup Wizard.**
- 2 Select an option.

### *To view information about functions*

- Scroll to a function and select **Info**, if available. In some cases, **Info** appears under **More**.

### *To view the phone demonstration*

- From standby select **Menu > Entertainment > Demo Tour.**

### **Settings download**

You can download settings to your phone. These settings let you use functionality that require Internet accounts, for example, picture messaging and email.

### *To download settings*

- From standby select **Menu > Settings > the General tab > Setup Wizard > Settings Download.**

- ! Contact your network operator or service provider for more information.

## Charging the Battery

The phone battery is partly charged when you buy it.

### To charge the battery

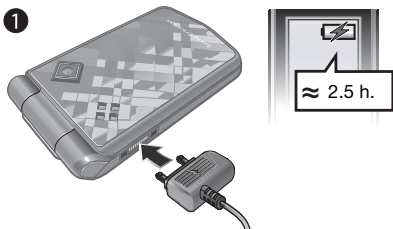

- 1 Connect the charger to the phone. It takes approximately 2.5 hours to fully charge the battery.
- 2 Remove the charger by tilting the plug upwards.

💡 You can use your phone while it is charging. You can charge the battery at any time and for more or less than 2.5 hours. You can interrupt the charging without damaging the battery.

## Phone Overview

- 1 Screen
- 2 Selection key
- 3 Connector for charger, handsfree and USB cable
- 4 Back key
- 5 Internet key
- 6 On/off key
- 7 Selection key
- 8 Clear key
- 9 Activity menu key
- 10 Navigation key
- 11 Silent key

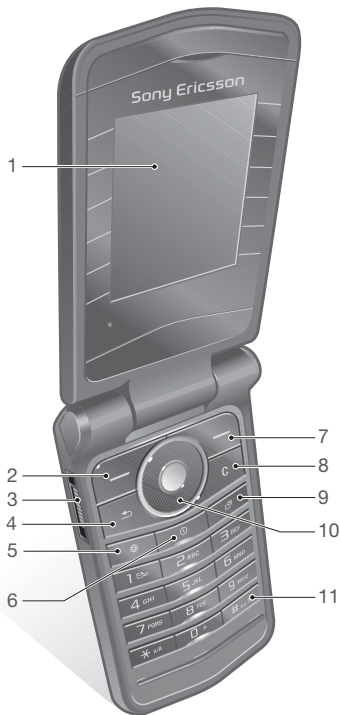

- 12 Gesture control light
- 13 Camera
- 14 Memory card slot (under the cover)
- 15 Volume buttons
- 16 External display

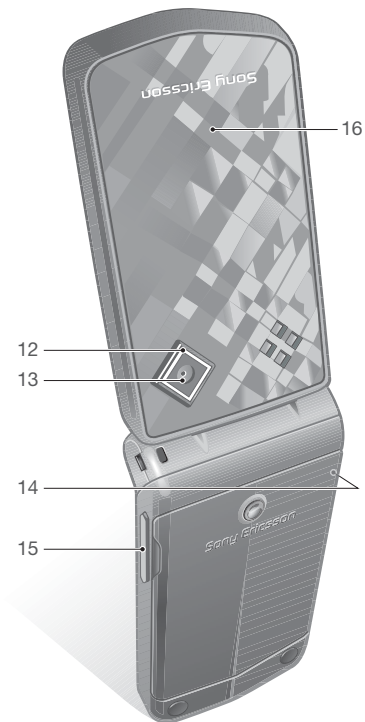

# Menu Overview



PlayNow™\*



Internet\*



Entertainment

Online Services\*  
Games  
Video Player  
MusicDJ™  
Record Sound  
Demo Tour



Camera



Messaging

Write New      Sent Messages  
Inbox          Saved Messages  
Email          My Friends\*  
RSS Reader    Call Voicemail  
Drafts        Templates  
Outbox        Settings



Music Player



File Manager\*\*



Contacts



Radio



Calls\*\*



All



Answered



Dialed



Missed



Organizer

Alarms  
Applications  
Calendar  
Tasks  
Notes  
Synchronization  
Timer  
Stopwatch  
Calculator  
Code Memo



## Settings\*\*



- General
- Profiles
- Time & Date
- Language
- Update Service
- Gesture control
- New Events
- Shortcuts
- Security
- Setup Wizard
- Phone Status
- Master Reset



- Sounds & Alerts
- Ring Volume
- Ringtone
- Silent Mode
- Increasing Ring
- Vibrating Alert
- Message Alert
- Key Sound



- Display
- Wallpaper
- Themes
- Startup Screen
- Screen Saver
- Brightness
- Edit Line Names\*



- Calls
- Speed Dial
- Forward Calls
- Switch to Line 2\*
- Manage Calls
- Time & Cost\*
- Show/Hide My No.
- Handsfree
- Open to Answer



- Connectivity
- Bluetooth
- USB Connection
- Synchronization
- Device Mgmt.
- Mobile Networks
- Data Comm.
- Internet Settings
- Accessories

\* Some menus are operator-, network- and subscription-dependent.

\*\* You can use the navigation key to scroll between tabs in submenus. For more information, see Navigation on page 13.

## Navigation

The main menus are shown as icons.  
Some submenus include tabs.

### *To navigate the phone menus*







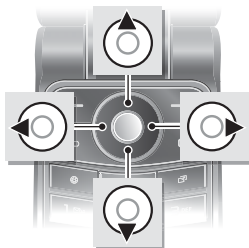

- 1 From standby select **Menu**.
- 2 Use the navigation key to move through the menus.

### *To scroll between the tabs*



- Scroll to a tab by pressing the navigation key left or right.



## Key

	Go to the main menus or select items
	Scroll between the menus and tabs
	Select options shown immediately above these keys on the screen
	Go back one level in the menus. Press and hold down to return to standby or end a function
	Delete items, such as pictures, sounds and contacts. Press and hold down to silence the microphone during a call
	Open the browser
	Turn the phone on/off
	Open the activity menu
	Press and hold down to call your voicemail service (if set)

---

 -  Press and hold down a number key to reach a contact beginning with a specific letter

---

 -  Press a number key and select **Call** to speed dial

---

 Press to turn off the ringtone when you receive a call.  
Press and hold down to set the phone to silent. The alarm signals even if your phone is set to silent

---

 Press to change letter case when writing a message.  
Press and hold down to toggle T9™ Text Input on and off when writing a message

---

 View status information in standby.  
Increase the volume during a call.  
Increase brightness when you use the camera.  
Press twice to reject a call

---

 Decrease the volume during a call.  
Decrease brightness when you use the camera

---





## Shortcuts

You can use keypad shortcuts to go directly to a menu. Menu numbering starts from the top left icon and moves across and then down row by row.

### *To go directly to the seventh menu*

- From standby select **Menu** and press .

### *To use navigation key shortcuts*

- From standby press , ,  or  to go directly to a function.



### *To edit a navigation key shortcut*

- 1 From standby select **Menu > Settings > the General tab > Shortcuts.**
- 2 Scroll to an option and select **Edit.**
- 3 Scroll to a menu option and select **Shortcut.**

## Activity Menu

The activity menu gives you fast access to certain functions.

### *To open the activity menu*

- Press .

### Activity menu tabs

- **New Events** – view missed calls and new messages. These can also be set to appear as pop-up texts.
- **Running Apps** – applications that are running in the background.
- **My Shortcuts** – add your favorite functions to access them quickly.
- **Internet** – your Internet bookmarks.

### *To select pop-up texts*

- From standby select **Menu > Settings > the General tab > New Events > Popup.**

## File Manager

You can use the file manager to handle items saved in the phone memory or on a memory card.

- ! You may have to purchase a memory card separately.

### Memory card

Your phone supports Memory Stick Micro™ (M2™) memory card adding more storage space to your phone. It can also be used as a portable memory card with other compatible devices.

### To insert a memory card



### To remove a memory card



- 1 Remove the battery cover.
- 2 Insert the memory card with the gold-colored contacts facing down.

- 1 Press the edge to release and remove the memory card.
- 2 Replace the battery cover.

### *To view memory card options*

- 1 From standby select **Menu > File Manager >** the **On Memory Stick** tab.
- 2 Select **More**.

### **Handling files**

You can move and copy files between your phone, a computer and a memory card. Files are saved on the memory card first and then in the phone memory. Unrecognized files are saved in the **Other** folder.

You can create subfolders to move or copy files to. When you handle files, you can select more than one or all the files in a folder at the same time for all items except **Games and Applications**.

If the memory is full, delete some content to create space.

### **File manager tabs**

The file manager is divided into three tabs, and icons indicate where the files are saved.

- **All Files** – all content in the phone memory and on a memory card.
- **On Memory Stick** – all content on a memory card.
- **In Phone** – all content in the phone memory.

### *To view information about files*

- 1 From standby select **Menu > File Manager**.
- 2 Scroll to a folder and select **Open**.
- 3 Scroll to a file and select **More > Information**.

### *To move a file in the file manager*

- 1 From standby select **Menu > File Manager**.
- 2 Scroll to a folder and select **Open**.
- 3 Scroll to a file and select **More > Manage File > Move**.
- 4 Select an option.

### *To select more than one file in a folder*

- 1 From standby select **Menu > File Manager**.
- 2 Scroll to a folder and select **Open**.
- 3 Select **More > Mark > Mark Several**.
- 4 Select **Mark** to mark the files.

### *To delete a file from the file manager*

- 1 From standby select **Menu > File Manager**.
- 2 Find the file and press **(C)**.

## **Phone Language**

You can select a language to use in your phone.

### *To change the phone language*

- 1 From standby select **Menu > Settings > the General tab > Language > Phone Language**.
- 2 Select an option.

## Entering Text

You can use multitap text input or T9™ Text Input **T9** to enter text. The T9 Text Input method uses a built-in dictionary.

### *To change text input method*

- When you enter text, press and hold down **(\*)a/A**.

### *To shift between capitals and lower-case letters*

- When you enter text, press **(\*)a/A**.

### *To enter numbers*

- When you enter text, press and hold down **(0+)** – **(9)**.

### *To enter periods and commas*

- When you enter text, press **(1=3=)**.

### *To enter text using T9™ Text Input*

- 1 From standby select, for example, **Menu > Messaging > Write New > Text Message**.

- 2 If **T9** is not displayed, press and hold down **(\*)a/A** to change to T9 Text Input.
- 3 Press each key only once, even if the letter you want is not the first letter on the key. For example, if you want to write the word “Jane”, press **(5)**, **(2)**, **(6)**, **(3)**. Write the whole word before looking at the suggestions.
- 4 Use **(↻)** or **(↺)** to view suggestions.
- 5 Press **(#↵)** to accept a suggestion.

### *To enter text using multitap*

- 1 From standby select, for example, **Menu > Messaging > Write New > Text Message**.
- 2 If **T9** is displayed, press and hold down **(\*)a/A** to change to multitap text input.
- 3 Press **(2)** – **(9)** repeatedly until the desired letter appears.
- 4 When a word is written, press **(#↵)** to add a space.

### *To add words to the built-in dictionary*

- 1 When you enter text using the T9 Text Input, select **More > Spell Word**.
- 2 Write the word using multitap input and select **Insert**.

# Calling

## Making and Receiving Calls

You need to turn on your phone and be within range of a network.

### To make a call

- 1 From standby enter a phone number (with international country code and area code, if applicable).
- 2 Select **Call**.

 You can call numbers from the contacts and call list. See *Contacts* on page 20, and *Call List* on page 22.

### To make international calls

- 1 From standby press and hold down  until a "+" sign appears.
- 2 Enter the country code, area code (without the first zero) and phone number.
- 3 Select **Call**.

### To re-dial a number

- When **Retry?** appears select **Yes**.

 Do not hold your phone to your ear when waiting. When the call connects, your phone gives a loud signal.

### To answer a call

- Select **Answer**.



### To reject a call

- Select **Busy**.

### To change the ear speaker volume during a call

- Press  or .

### To silence the microphone during a call

- 1 Press and hold down .
- 2 Press and hold down  again to resume.

### To turn the loudspeaker on during a call

- Select **More > Turn On Speaker**.

 Do not hold your phone to your ear when using the loudspeaker. This could damage your hearing.

### To view missed calls from standby

- Press  and scroll to the **New Events** tab and select a number.
- If pop-up is set: select **Calls** and scroll to the **Missed** tab and select a number.

## Emergency Calls

Your phone supports international emergency numbers, for example, 112 and 911. These numbers can normally be used to make emergency calls in any country, with or without the SIM card inserted, if a network is within range.

- ! *In some countries, other emergency numbers may also be promoted. Your network operator may therefore have saved additional local emergency numbers on the SIM card.*

### ***To make an emergency call***

- From standby enter 112 (the international emergency number) and select **Call**.

### ***To view your local emergency numbers***

- 1 From standby select **Menu > Contacts**.
- 2 Select **More > Options > Special Numbers > Emergency Nos.**

## **Contacts**

You can save names, phone numbers and personal information in **Contacts**. Information can be saved in the phone memory or on the SIM card.

### **Default contact**

You can choose which contact information – **Phone Contacts** or **SIM Contacts** – is shown as default.

If **Phone Contacts** is selected as default, your contacts show all the information saved in **Contacts**. If you select **SIM Contacts** as default, your contacts show names and numbers saved on the SIM card.

### ***To select default contacts***

- 1 From standby select **Menu > Contacts**.
- 2 Scroll to **New Contact** and select **Options > Advanced > Default Contacts**.
- 3 Select an option.

### **Phone contacts**

Phone contacts can contain names, phone numbers and personal information. They are saved in the phone memory.

### ***To add a phone contact***

- 1 From standby select **Menu > Contacts**.
- 2 Scroll to **New Contact** and select **Add**.
- 3 Enter the name and select **OK**.
- 4 Enter the number and select **OK**.
- 5 Select a number option.
- 6 Scroll between tabs and select the fields to add information.
- 7 Select **Save**.

### ***To add an item to a phone contact***

- 1 From standby select **Menu > Contacts**.
- 2 Scroll to a contact and select **More > Edit Contact**.
- 3 Scroll between the tabs and select **Add**.
- 4 Select an option and an item to add.
- 5 Select **Save**.

-  If your subscription supports Calling Line Identification (CLI) service, you can assign personal ringtones to contacts.

### **To copy names and numbers to the SIM card**

- 1 From standby select **Menu > Contacts**.
- 2 Select **More > Options > Advanced > Copy to SIM**.
- 3 Select an option.

-  When you copy all contacts from your phone to the SIM card, all existing SIM card information is replaced.

### **To call a phone contact**

- 1 From standby select **Menu > Contacts**.
- 2 Scroll to a contact and select **Call**.

-  To go directly to a contact, from standby press **(2)** - **(9)**. See Speed Dial on page 23.

### **To call a SIM contact from phone contacts**

- 1 From standby select **Menu > Contacts > More > Options > SIM Contacts**.
- 2 Scroll to a contact and select **Call**.

### **To automatically save names and phone numbers on the SIM card**

- 1 From standby select **Menu > Contacts**.
- 2 Select **More > Options > Advanced > Auto Save on SIM**.
- 3 Select an option.

## **SIM contacts**

SIM contacts can contain names and numbers only. They are saved on the SIM card.

### **To add a SIM contact**

- 1 From standby select **Menu > Contacts**.
- 2 Scroll to **New Contact** and select **Add**.
- 3 Enter the name and select **OK**.
- 4 Enter the number and select **OK**.
- 5 Select a number option and add more information, if available.
- 6 Select **Save**.

### **To copy names and numbers to phone contacts**

- 1 From standby select **Menu > Contacts**.
- 2 Select **More > Options > Advanced > Copy from SIM**.
- 3 Select an option.

### **To call a SIM contact**

- 1 From standby select **Menu > Contacts**.
- 2 Scroll to a contact and select **Call**.

## **Deleting contacts**

### **To delete a contact**

- 1 From standby select **Menu > Contacts**.
- 2 Scroll to a contact and press **(C)**.

### **To delete all phone contacts**

- 1 From standby select **Menu > Contacts**.
- 2 Select **More > Options > Advanced > Delete all contacts**.

## Sending contacts

### *To send a contact*

- 1 From standby select **Menu** > **Contacts**.
- 2 Scroll to a contact and select **More** > **Send Contact**.
- 3 Select a transfer method.

! *Make sure the receiving device supports the transfer method you select.*

### Memory status

The number of contacts you can save in your phone or on the SIM card depends on available memory.

### *To view memory status*

- 1 From standby select **Menu** > **Contacts**.
- 2 Select **More** > **Options** > **Advanced** > **Memory Status**.

### *To save contacts on a memory card*

- 1 From standby select **Menu** > **Contacts**.
- 2 Select **More** > **Options** > **Advanced** > **Back Up To M.S.**

### Synchronizing contacts

Contacts can be synchronized with your computer and some Web applications. For more information, see *Synchronizing* on page 50.

## Groups

You can create a group of phone numbers and email addresses to send messages to. See *Messaging* on page 27. You can also use groups (with phone numbers) when you create accepted callers lists. See *Accept Calls* on page 25.

### *To create a group of numbers and email addresses*

- 1 From standby select **Menu** > **Contacts** > **Options** > **Groups** > **New Group**.
- 2 Enter a name for the group and select **Continue**.
- 3 Select **New** to find and select a contact phone number or email address.
- 4 Repeat step 3 to add more phone numbers or email addresses.
- 5 Select **Done**.

## Call List

You can view information about most recent calls.

### *To call a number from the call list*

- 1 From standby select **Calls** and scroll to a tab.
- 2 Scroll to a name or a number and select **Call**.



### *To add a call list number to contacts*

- 1 From standby select **Calls** and scroll to a tab.
- 2 Scroll to the number and select **More** > **Save Number**.
- 3 Select **New Contact** to create a new contact or select an existing contact to add the number to.

### *To clear the call list*

- From standby select **Calls** > the **All** tab > **More** > **Delete All**.

## Speed Dial

Speed dialing lets you select nine contacts that you can dial quickly. The contacts can be saved in positions 1-9.

### *To add contacts to speed dial numbers*

- 1 From standby select **Menu** > **Contacts**.
- 2 Select **Options** > **Speed Dial**.
- 3 Scroll to a position number and select **Add**.
- 4 Select a contact.

### *To speed dial*

- From standby enter the position number and select **Call**.



## Voicemail

If your subscription includes an answering service, callers can leave a voicemail message when you cannot answer a call.

### *To enter your voicemail number*

- 1 From standby select **Menu** > **Messaging** > **Settings** > **Voicemail Number**.
- 2 Enter the number and select **OK**.

### *To call your voicemail service*

- From standby press and hold down .

### *To edit your voicemail number*

- 1 From standby select **Menu** > **Messaging** > **Settings** > **Voicemail Number**.
- 2 Edit the number and select **OK**.



## Forwarding Calls

You can forward calls, for example, to an answering service.



*When Restrict Calls is used, some forward call options are not available. See Restricted Dialing on page 26.*

### Forward call options

Standard options are:

- **Always Forward** – forward all your calls
- **When Busy** – if a call is ongoing
- **Not Reachable** – if turned off or unreachable
- **No Reply** – if not answered in a specified time

### *To forward calls*

- 1 From standby select **Menu > Settings > the Calls tab > Forward Calls**.
- 2 Scroll to a call type and forward option and select **Activate**.
- 3 Enter the number to forward calls to and select **OK**.



## **More than One Call**

You can handle more than one call at the same time. For example, you can put an ongoing call on hold, while you make or answer a second call. You can also switch between the two calls. You cannot answer a third call without ending one of the first two calls.

### **Call waiting**

When call waiting is used, you hear a beep if you receive a second call.

### *To activate call waiting*

- From standby select **Menu > Settings > the Calls tab > Manage Calls > Call Waiting > Activate**.

### *To make a second call*

- 1 During the call, select **More > Hold**. This puts the ongoing call on hold.
- 2 Enter the number to call and select **More > Call**.

### *To answer a second call*

- During the call, select **Answer**. This puts the ongoing call on hold.

### *To reject a second call*

- During the call, select **Busy** and continue with the ongoing call.

### *To end an ongoing call and answer a second call*

- During the call, select **Replace Active Call**.



## **Handling two voice calls**

You can have calls ongoing and on hold at the same time.

### *To switch between two calls*

- During the call, select **More > Switch**.

### *To join two calls*

- During the call, select **More > Join Calls**.

### *To connect two calls*

- During the call, select **More > Transfer Call**. You are disconnected from both calls (operator-dependent).

### *To end an ongoing call and return to the call on hold*

- Select **End Call > Yes**.

### *To end both calls*

- Select **End Call > No**.

## Receiving a third voice call

You cannot answer a third call without ending one of the first two calls or joining them into a conference call.



## Conference Calls

With a conference call, you can have a joint conversation with up to five people.

### *To join the two calls*

- During the call, select **More > Join Calls**.

### *To add a new participant*

- 1 During the call, select **More > Hold**. This puts the joined calls on hold.
- 2 Select **More > Add Call**.
- 3 Enter the number to call and select **Call**.
- 4 Select **More > Join Calls** to add the new participant.
- 5 Repeat this task to add more participants.

### *To release a participant*

- 1 Select **More > Release Party**.
- 2 Select the participant to release.

### *To have a private conversation*

- 1 During the call, select **More > Talk to** and select the participant to talk to.
- 2 To resume the conference call, select **More > Join Calls**.



If your subscription supports Alternate Line Service (ALS), you can make separate calls with different phone numbers.

## My Numbers

You can view, add and edit your own phone numbers.

### *To check your phone numbers*

- 1 From standby select **Menu > Contacts > Options > Special Numbers > My Numbers**.
- 2 Select an option.

## Accept Calls

You can choose to receive calls from certain phone numbers only.

### *To add numbers to the accepted callers list*

- 1 From standby select **Menu > Settings > the Calls tab > Manage Calls > Accept Calls > Only from List > New**.
- 2 Scroll to a contact or select Groups. See *Groups* on page 22.

### *To accept all calls*

- From standby select **Menu > Settings > the Calls tab > Manage Calls > Accept Calls > All Callers**.



## Restricted Dialing

You can restrict outgoing and incoming calls. A password from your service provider is required.



*If you forward incoming calls, you cannot use some restrict calls options.*

### Restrict calls options

Standard options are:

- **All Outgoing** – all outgoing calls
- **Outgoing Intl.** – all outgoing international calls
- **Outg Intl Roam** – all outgoing international calls except to your home country
- **All Incoming** – all incoming calls
- **Inc. Whn Roaming** – all incoming calls when you are abroad

### To restrict calls

- 1 From standby select **Menu > Settings > the Calls tab > Manage Calls > Restrict Calls.**
- 2 Select an option.
- 3 Enter your password and select **OK.**



## Fixed Dialing

Fixed dialing allows calls to be made only to certain numbers saved on the SIM card. The fixed numbers are protected by your PIN2.



*When fixed dialing is used, you can still call the international emergency number, 112.*

Partial numbers can be saved. For example, saving 0123456 allows calls to be made to all numbers starting with 0123456.



*When fixed dialing is used, you cannot view or manage any phone numbers saved on the SIM card.*

### To use fixed dialing

- 1 From standby select **Menu > Contacts.**
- 2 Select **More > Options > Special Numbers > Fixed Dialing > Activate.**
- 3 Enter your PIN2 and select **OK.**
- 4 Select **OK** again to confirm.

### To save a fixed number

- 1 From standby select **Menu > Contacts.**
- 2 Select **More > Options > Special Numbers > Fixed Dialing > Fixed Numbers > New Number.**
- 3 Enter the information and select **Save.**



## Call Time and Cost

During a call, the duration of the call is shown. You can check the duration of your last call, outgoing calls and the total time of your calls.

### *To check the call time*

- From standby select **Menu > Settings > the Calls tab > Time & Cost > Call Timers.**

## **Business Cards**

### *To add your own business card*

- 1 From standby select **Menu > Contacts.**
- 2 Select **More > Options > My Business Card.**
- 3 Scroll between tabs and select the fields to add information. To enter a symbol select **More > Add Symbol > Insert.**
- 4 Enter the information and select **Save.**

### *To send your business card*

- 1 From standby select **Menu > Contacts.**
- 2 Select **More > Options > My Business Card > Send My Card.**
- 3 Select a transfer method.



*Make sure the receiving device supports the transfer method you select.*

# **Messaging**

## **Text Messages**

Text messages can contain simple pictures, sound effects, animations, and melodies.

### **Before you use messaging**

You must have a service center number. The number is supplied by your service provider and is usually saved on the SIM card. If the number to your service center is not saved on your SIM card, you must enter the number yourself.

### *To enter a service center number*

- 1 From standby select **Menu > Messaging > Settings > Text Message > Service Center.** The number is shown if it is saved on the SIM card.
- 2 If there is no number shown, select **Edit > New ServiceCenter** and enter the number, including the international “+” sign and country code.
- 3 Select **Save.**

### **Sending messages**

For information about entering letters, see *Entering Text* on page 18.

### *To write and send a text message*

- 1 From standby select **Menu**  
> **Messaging** > **Write New**  
> **Text Message**.
- 2 Write the message and select **Continue** > **Contacts Lookup**.
- 3 Select a recipient and select **Send**.

! If you send a text message to a group, you will be charged for each member. See *Groups* on page 22.

### *To select more than one text message*

- 1 From standby select **Menu**  
> **Messaging** and select a folder.
- 2 Scroll to a message and select **More**  
> **Mark Several**.
- 3 Select **Mark** to mark the messages.

### *To add an item to a text message*

- 1 When you write the message, select **More** > **Add Item**.
- 2 Select an option and then an item.

### **Receiving text messages**

You are notified when you receive a message. Received messages are saved in the inbox.

### *To view a text message from standby*

- If the activity menu is set: select **View**.
- If pop-up is set: follow the instructions on the screen.

### *To view a text message from the inbox*

- 1 From standby select **Menu**  
> **Messaging** > **Inbox**.
- 2 Scroll to the message and select **View**.

### *To close a text message*

- Press .

### *To call a number in a text message*

- When you view the message, scroll to the phone number and select **Call**.

### **Saving and deleting text messages**

Received text messages are saved in the phone memory. When the phone memory is full, you can delete messages or move them to the SIM card.

### *To save a text message on the SIM card*

- 1 From standby select **Menu**  
> **Messaging** and select a folder.
- 2 Scroll to the message and select **More**  
> **Save Message** > **Saved Messages**.

### *To save an item in a text message*

- 1 When you view the message, select the item.
- 2 Select **More** > **Use**.
- 3 Select an option.

### *To delete a text message*

- 1 From standby select **Menu**  
> **Messaging** and select a folder.
- 2 Scroll to the message and press .

## Picture Messages

Picture messages can contain text, pictures, slides, sound recordings, signatures and attachments. You can send picture messages to a phone or an email address.

### Before you use picture messaging

You must set an Internet profile and the address of your message server. If no Internet profile or message server exists, you can receive all the settings automatically from your network operator or at [www.sonyericsson.com/support](http://www.sonyericsson.com/support).

### To select an Internet profile

- 1 From standby select **Menu**  
> **Messaging** > **Settings** > **Picture Message** > **MMS Profile**.
- 2 Select a profile.

### To set the message server address

- 1 From standby select **Menu**  
> **Messaging** > **Settings** > **Picture Message** > **MMS Profile**.
- 2 Scroll to a profile and select **More**  
> **Edit** > **Message Server**.
- 3 Select **Edit** and enter the address.

### Sending messages

For information about entering letters, see *Entering Text* on page 18.

### To create and send a picture message

- 1 From standby select **Menu**  
> **Messaging** > **Write New** > **Picture Message**.
- 2 Enter the text and press  to add items to the message.
- 3 Select **Continue** > **Contacts Lookup**.
- 4 Scroll to a recipient and select **Send**.

### Receiving picture messages

You can select how to download your picture messages. Standard options when you download picture messages are:

- **Always** – automatic download.
- **Ask in Roaming** – ask to download when not in home network.
- **Not in Roaming** – do not download when not in home network.
- **Always Ask** – ask to download.
- **Off** – new messages appear in the Inbox.

### To set automatic download

- 1 From standby select **Menu**  
> **Messaging** > **Settings** > **Picture Message** > **Auto Download**.
- 2 Select an option.

### *To view a picture message from standby*

- If the activity menu is set: select **View**.
- If pop-up is set: follow the instructions on the screen.

### *To view a picture message from the inbox*

- 1 From standby select **Menu** > **Messaging** > **Inbox**.
- 2 Scroll to the message and select **View**.

### *To close a picture message*

- Press .

### *To save an item in a picture message*

- When you view a picture message select **More** > **Save Items** and select an item.

### *To delete a message*

- 1 From standby select **Menu** > **Messaging** and select a folder.
- 2 Scroll to the message and press .

### **Message options**

You can set standard options for all messages or choose specific settings each time you send a message.

### *To set text message options*

- 1 From standby select **Menu** > **Messaging** > **Settings** > **Text Message**.
- 2 Scroll to an option and select **Edit**.

### *To set picture message options*

- 1 From standby select **Menu** > **Messaging** > **Settings** > **Picture Message**.
- 2 Scroll to an option and select **Edit**.

### **Send options**

You can request a delivery report, a read report, and set a priority for a specific message. You can also add more recipients to the message.

### *To set send options*

- 1 When the message is ready and a recipient is selected, select **More** > **Advanced**.
- 2 Scroll to an option and select **Edit**.

## **Templates**

If you often use the same phrases and pictures in a message, you can save the message as a template.

### *To use a text message template*

- 1 From standby select **Menu** > **Messaging** > **Templates**.
- 2 Scroll to a template and select **Use** > **Text Message**.
- 3 Add text and select **Continue** and select a recipient.



### *To use a picture message template*

- 1 From standby select **Menu**  
> **Messaging** > **Templates**.
- 2 Scroll to a template and select **Use**.
- 3 When the message is ready, select **Continue** and select a recipient.

### *To add a text message template*

- 1 From standby select **Menu**  
> **Messaging** > **Templates** > **New Template** > **Text**.
- 2 Insert text or select **More** to add items. Select **OK**.
- 3 Enter a title and select **OK**.

### *To add a picture message template*

- 1 From standby select **Menu**  
> **Messaging** > **Templates** > **New Template** > **Picture Msg**.
- 2 Enter the text and press  to add items to the message.
- 3 Select **Save**, enter a title and select **OK**.

### *To edit a template*

- 1 From standby select **Menu**  
> **Messaging** > **Templates**.
- 2 Scroll to a template and select **More**  
> **Edit Template** > **Save**.

### *To save a message as a template*

- 1 From standby select **Menu**  
> **Messaging** > **Inbox**.
- 2 Scroll to the message and select **More**  
> **Save Message** > **Templates**.

## **Voice Messages**

You can send and receive a sound recording as a voice message.

- ! *The sender and recipient must have a subscription supporting picture messaging.*

### *To record and send a voice message*

- 1 From standby select **Menu**  
> **Messaging** > **Write New** > **Voice Message**.
- 2 Record the message and select **Stop**  
> **Send** > **Contacts Lookup**.
- 3 Select a recipient and select **Send**.

## **Email**

You can use standard email functions and your computer email address in your phone.

### **Before you use email**

Email settings must be entered in your phone. You can have these settings sent directly to your phone from the Sony Ericsson support site, or you can enter them manually.

### **Email settings using Internet**

You can receive settings at [www.sonyericsson.com/support](http://www.sonyericsson.com/support).

## Entering email settings manually

You can also enter the email settings manually. To do this, you need to ask your email provider for the settings information:

Settings types	Examples
Connection Type	POP3 or IMAP4
Email Address	joe.smith@ example.com
Incoming Server	mail.example.com
Username	jsmith
Password	zX123
Outgoing Server	mail.example.com

An email provider could be the company that supplied your email address, for example, your IT administrator at work or an Internet provider.

You may find settings information in your computer email program settings, or in a document from your email provider.



 *There are many different email providers. Their terminology and required information may differ. Not all service providers allow email access.*

## To enter email settings

- 1 From standby select **Menu** > **Messaging** > **Email** > **Settings**.
- 2 Enter the settings.  
Help appears as you enter settings.

 *For more information, contact your email provider or go to [www.sonyericsson.com/support](http://www.sonyericsson.com/support).*

## To write and send an email message

- 1 From standby select **Menu** > **Messaging** > **Email** > **Write New**.
- 2 Select **Add** > **Enter Email Addr.** Enter the email address and select **OK**.
- 3 To enter more recipients, select **Edit**. Scroll to an option and select **Add** > **Enter Email Addr.** Enter the email address and select **OK**. When you are ready, select **Done**.
- 4 Press  to scroll to **Subject:**. Select **Edit** and enter a subject.
- 5 Press  to scroll to **Text:**. Select **Edit** and enter the text.
- 6 Press  to scroll to **Attachments:**. Select **Add** and select a file to attach.
- 7 Select **Continue** > **Send**.

## To receive and read an email message

- 1 From standby select **Menu** > **Messaging** > **Email** > **Inbox** > **Snd&Rec**.
- 2 Scroll to the message and select **View**.

### *To save an email message*

- 1 From standby select **Menu**  
> **Messaging** > **Email** > **Inbox**.
- 2 Scroll to the message and select **More**  
> **Save Message** > **Saved Email**.

### *To reply to an email message*

- 1 From standby select **Menu**  
> **Messaging** > **Email** > **Inbox**.
- 2 Scroll to the message and select **More**  
> **Reply**.
- 3 Write the reply and select **OK**.
- 4 Select **Continue** > **Send**.

### *To view an attachment in an email message*

- When you view the message, select **More** > **Attachments** > **View**.

### *To save an attachment in an email message*

- When you view the message, select **More** > **Attachments** > **View** > **Save**.

### *Active email account*

If you have several email accounts, you can change which one is active.

### *To change the active email account*

- 1 From standby select **Menu**  
> **Messaging** > **Email** > **Settings**.
- 2 Select an account.

### *To delete an email message (POP3)*

- 1 From standby select **Menu**  
> **Messaging** > **Email** > **Inbox**.
- 2 Scroll to the message and select **More**  
> **Mrk for Deletion** > **Yes**.

! *Marked messages will be deleted when you next connect to your server.*

### *To delete an email message (IMAP4)*

- 1 From standby select **Menu**  
> **Messaging** > **Email** > **Inbox**.
- 2 Scroll to the message and select **More**  
> **Mrk for Deletion** > **Yes**.
- 3 Select **More** > **Clear Inbox**.

! *Marked messages will be deleted in the phone and on the server.*

### *Push email*

You can receive notification in your phone from your email server that you have new email.

### *To turn on push email notification*

- 1 From standby select **Menu**  
> **Messaging** > **Email** > **Settings**.
- 2 Scroll to an account to edit and select **More** > **Edit Account** > **Advanced Settings** > **Push Email**.
- 3 Select an option.

## My Friends

You can connect and log in to the My friends server to communicate online with chat messages.

### Before you use My friends

If no settings exist in your phone, you need to enter server settings. Standard settings information supplied by your service provider is:

- username
- password
- server address
- Internet profile

### To enter My friends server settings

- 1 From standby select **Menu**  
> **Messaging** > **My Friends**  
> **Configure**.
- 2 Select **Add** and enter the settings.

### To edit My friends settings

- 1 From standby select **Menu**  
> **Messaging** > **My Friends**.
- 2 Select **More** > **Settings**.
- 3 Scroll to the setting and press **Select**.

### To log in to the My friends server

- From standby select **Menu**  
> **Messaging** > **My Friends** > **Log In**.

### To log out of the My friends server

- Select **More** > **Log Out**.

### To add a chat contact

- 1 From standby select **Menu**  
> **Messaging** > **My Friends**  
> the **Contacts** tab.
- 2 Select **More** > **Add Contact**.

### To send a chat message

- 1 From standby select **Menu**  
> **Messaging** > **My Friends**  
> the **Contacts** tab.
- 2 Scroll to a contact and select **Chat**.
- 3 Write the message and select **Send**.

### Status

You can show your status, for example, **Happy** or **Busy**, to your contacts only. You can also show your status to all users on the My friends server.

### To show my status

- 1 From standby select **Menu**  
> **Messaging** > **My Friends** > **More**  
> **Settings** > **Show My Status**.
- 2 Select an option.

### To update your own status

- 1 From standby select **Menu**  
> **Messaging** > **My Friends**  
> the **My Status** tab.
- 2 Scroll between tabs and select the fields to add information.

## Chat group

A chat group can be started by your service provider, by an individual My friends user or by yourself. You can save chat groups by saving a chat invitation or by searching for a specific chat group.

### *To create a chat group*

- 1 From standby select **Menu** > **Messaging** > **My Friends** > the **Chat Groups** tab.
- 2 Select **More** > **Add Chat Group** > **New Chat Group**.
- 3 Select who to invite from your contacts list and select **Continue**.
- 4 Enter a short invitation text and select **Continue** > **Send**.

### *To add a chat group*

- 1 From standby select **Menu** > **Messaging** > **My Friends** > the **Chat Groups** tab > **More** > **Add Chat Group**.
- 2 Select an option.

- ! *Conversation history is saved between log out and when you log in again to let you return to chat messages from previous conversations.*

### *To save a conversation*

- 1 From standby select **Menu** > **Messaging** > **My Friends** > the **Conversations** tab.
- 2 Scroll to a conversation and select **More** > **Advanced** > **Save Conv.**

### *To view a saved conversation*

- 1 From standby select **Menu** > **Messaging** > **My Friends** > the **Conversations** tab.
- 2 Select **More** > **Saved Conv.**



## Area and Cell Information

Area and cell information are text messages, for example, local traffic reports that are sent to subscribers within a certain network area.

- ! *Contact your service provider for more information.*

### *To turn area information on*

- 1 From standby select **Menu** > **Messaging** > **Settings** > **Area Info**.
- 2 Scroll to **Reception** and select **Edit** > **On**.

# Imaging

## Camera

You can take pictures to view, save or send.



### *To activate the camera*

- From standby select **Menu > Camera**.

### *To take a picture*

- 1 Activate the camera.
- 2 Select **Capture** to take a picture.
- 3 Press to take another picture.
- 4 Press and hold down to stop the camera.

### *To use zoom*

- Press or .

### *To adjust brightness*

- Press or .

### *Saving and deleting pictures*

All camera pictures are saved in the camera album.

### *To view pictures*

- 1 From standby select **Menu > File Manager > Camera Album**.
- 2 Scroll to an item and select **View**.

### *To search camera pictures by time line*

- 1 From standby select **Menu > File Manager > Camera Album**.
- 2 To browse camera pictures sorted by date, select **More > Timeline View**.

### To delete pictures

- 1 From standby select **Menu > File Manager > Camera Album**.
- 2 Scroll to an item and press .

### Camera settings

You can select different settings before you take a picture.





#### To view settings

- When the camera is activated, select **More**.

#### To view information about settings

- Scroll to a setting and select **Info**.

### Camera shortcuts

Key	Shortcut
	Shoot Mode
	Picture Size
	Night Mode
	Key guide

## Transferring Pictures

### Transfer to and from your computer

You can use Bluetooth technology and picture messages to transfer pictures to your computer. You can also use the USB cable to drag and

drop camera pictures. See *Bluetooth™ Wireless Technology* and *Using the USB Cable* on page 49.

You can view, enhance and organize your pictures on your computer by installing *Adobe™ Photoshop™ Album Starter Edition* or the *Sony Ericsson Media Manager*. These are available for download at [www.sonyericsson.com/support](http://www.sonyericsson.com/support).

### Picture blog

A picture blog is a personal Web page. If your subscription supports this service, you can send pictures to a blog.

- ! *Web services may require a separate license agreement between you and the service provider. Additional regulations and/or charges may apply. Contact your service provider.*

#### To send camera pictures to a blog

- 1 From standby select **Menu > File Manager > Camera Album**.
- 2 Scroll to a picture and select **More > Send > To Blog**.
- 3 Add title and text.
- 4 Select **OK > Publish**.

### *To go to a blog address from contacts*

- 1 From standby select **Menu > Contacts**.
- 2 Scroll to a contact.
- 3 Scroll to a Web address and select **Go To**.

## **Pictures**

You can view, add, edit or delete pictures in **File Manager**. File types supported are, for example, GIF, JPEG, BMP and PNG.

### **Using pictures**

You can add a picture to a contact, use it during phone startup, as a wallpaper in standby or as a screen saver.

### *To view pictures*

- 1 From standby select **Menu > File Manager > Pictures**.
- 2 Scroll to a picture and select **View**.

### *To use pictures*

- 1 From standby select **Menu > File Manager > Pictures**.
- 2 Scroll to a picture and select **More > Use As**.
- 3 Select an option.

### *To view pictures in a slide show*

- 1 From standby select **Menu > File Manager > Pictures**.
- 2 Scroll to a picture and select **View > More > Slide Show**.

### **Sending and receiving**

You can send and receive pictures as a picture message, an email or using Bluetooth.

### *To send a picture*

- 1 From standby select **Menu > File Manager > Pictures**.
- 2 Scroll to a picture and select **More > Send**.
- 3 Select a transfer method.

- ! *Make sure the receiving device supports the transfer method you select.*

### *To receive a picture*

- Follow the instructions that appear.



# Entertainment

## Stereo Portable Handsfree



### To use the handsfree

- Connect the portable handsfree. Music stops when you receive a call and resumes when the call has ended.

## Transferring Music from a Computer

With Sony Ericsson Media Manager, you can transfer music from CDs, your computer or that you have purchased to the phone memory or a memory card.

- 💡 Sony Ericsson Media Manager software is available for download at [www.sonyericsson.com/support](http://www.sonyericsson.com/support).

Before you use Media Manager You need one of these operating systems to use *Media Manager* on your computer:

- Microsoft® Windows Vista™ (32 bit and 64 bit versions of: Ultimate, Enterprise, Business, Home Premium, Home Basic)
- Microsoft Windows® XP (Pro or Home)

### To install Media Manager

- Download and install Sony Ericsson Media Manager software from [www.sonyericsson.com/support](http://www.sonyericsson.com/support). The software includes help information.

### To use Media Manager

- 1 Connect the phone to a computer with a USB cable.
- 2 Select File Transfer. The phone turns off and prepares to transfer files.
- 3 Computer: *Start/Programs/Sony Ericsson/Media Manager*.

! Do not remove the USB cable from your phone or computer during transfer, as this may corrupt the memory card or the phone memory.

- 4 For safe disconnection of the USB cable in file transfer mode, right-click the removable disk icon in *Windows*

Explorer and select *Eject*. See *Using the USB Cable* on page 49. For details on transferring music, see *Media Manager Help*. Click (?) in the top-right corner of the Media Manager window.



## Radio

! Do not use your phone as a radio in places where this is prohibited.

### To listen to the radio

- 1 Connect the handsfree to the phone.
- 2 From standby select **Menu > Radio**.



### To change the volume

- When the radio is playing, press  or .



### To automatically search for radio channels

- When the radio is playing, select **Search**.

### To manually search for radio channels

- When the radio is playing, press  or .

### To search for preset channels

- When the radio is playing, press  or .

## Saving radio channels

You can save up to 20 preset channels.



### To save radio channels

- 1 From standby select **Menu > Radio**.
- 2 Select **Search** to find a radio channel.
- 3 Select **More > Save**.
- 4 Scroll to a position and select **Insert**.



### To select saved radio channels

- 1 From standby select **Menu > Radio > More > Channels**.
- 2 Select a radio channel.

### To save radio channels in positions 1 to 10

- When you have found a radio channel, press and hold down  - .

### To select radio channels saved in positions 1 to 10

- When the radio is playing, press  - .

### To view radio options

- When the radio is playing, select **More**.

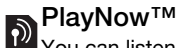

You can listen to music before you purchase and download it to your phone.

- ! This service is not available in all countries. Contact your network operator for more information. In some countries you can purchase music from some of the world's top musical artists.

### Before you use PlayNow™

You must have the required settings in your phone. See *Settings* on page 44.

### To listen to PlayNow™ music

- 1 From standby select **Menu** > **PlayNow™**.
- 2 Select music from a list.

### Downloading from PlayNow™

The price appears when you select to download and save a music file. Your phone bill or prepay card is debited when a purchase is accepted.

### To download a music file



- 1 When you have listened to a music file preview, you can agree to accept the conditions.
- 2 Select **Yes** to download.
- 3 A text message is sent to confirm payment and the file is made available to download.

## Ringtones and Melodies

### To set a ringtone

- 1 From standby select **Menu** > **Settings** > the **Sounds & Alerts** tab > **Ringtone**.
- 2 Select an option.

### To set the ringtone volume

- 1 From standby select **Menu** > **Settings** > the **Sounds & Alerts** tab > **Ring Volume**.
- 2 Press  or  to change the volume.
- 3 Select **Save**.

### To turn the ringtone off

- From standby press and hold down  .  
All signals except the alarm signal are affected.

### To set the vibrating alert

- 1 From standby select **Menu** > **Settings** > the **Sounds & Alerts** tab > **Vibrating Alert**.
- 2 Select an option.

### To send a ringtone

- 1 From standby select **Menu** > **File Manager** > **Music** > **Ringtones**.
- 2 Scroll to a ringtone and select **More** > **Send**.
- 3 Select a transfer method.

- ! *Make sure the receiving device supports the transfer method you select.*

### **To receive a ringtone**





- Follow the instructions that appear.

- ! *You are not allowed to exchange some copyright-protected material. A protected file has a key symbol.*

## **MusicDJ™**

You can compose and edit your own melodies to use as ringtones. A melody consists of four types of tracks – **Drums**, **Basses**, **Chords**, and **Accents**. A track contains a number of music blocks. The blocks consist of pre-arranged sounds with different characteristics. The blocks are grouped into **Intro**, **Verse**, **Chorus**, and **Break**. You compose a melody by adding music blocks to the tracks.

### **To compose a melody**

- 1 From standby select **Menu** > **Entertainment** > **MusicDJ™**.
- 2 Select to **Insert**, **Copy** or **Paste** blocks.
- 3 Use , ,  or  to scroll between the blocks.
- 4 Select **More** > **Save Melody**.

### **To send a melody**

- 1 From standby select **Menu** > **File Manager**.
- 2 Scroll to **Music** and select **Open**.
- 3 Scroll to a melody and select **More** > **Send**.
- 4 Select a transfer method.

- ! *Make sure the receiving device supports the transfer method you select.*

### **To receive a melody**

- Follow the instructions that appear.
- ! *You cannot send a polyphonic melody or MP3 file in a text message.*

## **Sound Recorder**

You can record a voice memo. Recorded sounds can also be set as ringtones.

### **To record a sound**

- From standby select **Menu** > **Entertainment** > **Record Sound**.

### **To listen to a recording**

- 1 From standby select **Menu** > **File Manager** > **Music**.
- 2 Scroll to a recording and **Play**.

## Video Player

### *To play videos*

- 1 From standby select **Menu** > **Entertainment** > **Video Player**.
- 2 Scroll to a title and select **Play**.

### Video controls



#### *To stop playing videos*

- Press .



#### *To resume playing videos*

- Press .

#### *To go to the next or previous clip*

- When playing video clips, press  or .

#### *To fast forward or rewind*

- When playing video clips, press and hold down  or .

#### *To change the volume*

- Press  or .

## Games

Your phone contains pre-loaded games. You can also download games. Help texts are available for most games.

### *To start a game*

- 1 From standby select **Menu** > **Entertainment** > **Games**.
- 2 Select a game.

### *To end a game*

- Press and hold down .

## Applications

### **Before you use Java™ applications**

If settings are not already entered in your phone, see *Settings* on page 44.

You can download and run Java applications. You can also view information or set different permissions.

### *To select a Java application*

- 1 From standby select **Menu** > **File Manager** > **Applications**.
- 2 Select an application.

### *To view information about a Java application*

- 1 From standby select **Menu** > **File Manager** > **Applications**.
- 2 Scroll to an application and select **More** > **Information**.

### *To set permissions for a Java application*

- 1 From standby select **Menu > File Manager > Applications.**
- 2 Scroll to an application and select **More > Permissions.**

### *To set the screen size for a Java application*

- 1 From standby select **Menu > File Manager > Applications.**
- 2 Scroll to an application and select **More > Screen Size.**
- 3 Select an option.

### **Internet profiles for Java applications**

Some Java applications need to connect to the Internet to receive information.

### *To select an Internet profile for Java applications*

- 1 From standby select **Menu > Settings > the Connectivity tab > Internet Settings > Settings for Java.**
- 2 Select an option.

## Connectivity

### Settings

Before you use Internet, PlayNow™, My friends, Java, remote synchronization, picture messaging, email and picture blog you need to have settings in your phone.

If settings are not already entered, make sure your phone supports data transfer. You can download settings using the setup wizard or from [www.sonyericsson.com/support](http://www.sonyericsson.com/support).

### *To download settings using the Setup wizard*

- 1 From standby select **Menu > Settings > the General tab > Setup Wizard > Settings Download.**
- 2 Follow the instructions on the screen.

### *To download settings using a computer*

- 1 Go to [www.sonyericsson.com/support](http://www.sonyericsson.com/support).
- 2 Follow the instructions on the screen.

## Using Internet

You can use the Internet to access online services.

### *To start browsing*

- From standby select **Menu > Internet.**

### *To exit the browser*

- When you browse the Internet, select **More > Exit Browser**.

### *To view options*

- When you browse the Internet, select **More**.

### *When you browse the Internet*

You can make a call or send a link when you browse the Internet.

### *To make a call*

- When you browse the Internet, select **More > Tools > Make a Call**.

### *To send a link*

- 1 When you browse the Internet, select **More > Tools > Send Link**.
- 2 Select an option.

### *Using bookmarks*

You can create and edit bookmarks as quick links to your favorite Web pages.

### *To create a bookmark*

- 1 From standby select **Menu > Internet > More > Go to > Bookmarks**.
- 2 Scroll to **New Bookmark** and select **Add**.
- 3 Enter the information and select **Save**.

### *To select a bookmark*











- 1 From standby select **Menu > Internet > More > Go to > Bookmarks**.
- 2 Scroll to a bookmark and select **Go To**.

### *Internet keypad shortcuts*

You can use the keypad to go directly to an Internet browser function.

### *To select Internet keypad shortcuts*

- From standby select **Menu > Internet > More > Options > the Browsing tab > Keypad Mode > Shortcuts**.

Key	Shortcut
	Bookmarks
	Enter Address
	Search Internet
	History
	Refresh Page
	Forward
	Page up
	Page down
	Full Screen or Normal Screen
	Zoom
	Shortcuts

## Downloading

You can download files, for example, pictures, themes, games and ringtones from Web pages.

### *To download from a Web page*

- 1 When you browse the Internet, select a file to download.
- 2 Follow the instructions on the screen.

## Internet profiles

You can select another Internet profile if you have more than one.

### *To select an Internet profile for the Internet browser*

- 1 From standby select **Menu > Settings > the Connectivity tab > Internet Settings > Internet Profiles.**
- 2 Select an option.

## Internet security and certificates

Your phone supports secure browsing. Certain Internet services, such as banking, require certificates in your phone. Your phone may already contain certificates when you buy it or you can download new certificates.

### *To view certificates in the phone*

- From standby select **Menu > Settings > the General tab > Security > Certificates.**

## RSS Reader

You can receive frequently updated content, such as news headlines, as feeds, using Really Simple Syndication (RSS).

### *To add new feeds for a Web page*

- When you browse the Internet, select **More > RSS Feeds.**

### *To create a new feed*

- 1 From standby select **Menu > Messaging > RSS Reader > More > New Feed.**
- 2 Enter the address and select **Go To.**

### *To set and use RSS reader options*

- 1 From standby select **Menu > Messaging > RSS Reader > More.**
- 2 Select an option.

## Bluetooth™ Wireless Technology

The Bluetooth function makes wireless connection to other Bluetooth devices possible. You can, for example:

- Connect to handsfree devices.
- Connect to stereo headsets.
- Connect to more than one device at the same time.
- Connect to computers and access the Internet.



- Synchronize information with computers.
- Use media viewer accessories.
- Exchange items and play multiplayer games.

**!** *We recommend a range within 10 metres (33 feet), with no solid objects in between, for Bluetooth communication.*

### **Before you use Bluetooth wireless technology**

You must turn on the Bluetooth function to communicate with other devices. You must also pair your phone with other Bluetooth devices.

#### ***To turn the Bluetooth function on***

- From standby select **Menu > Settings > the Connectivity tab > Bluetooth > Turn On.**

**!** *Make sure that the device you want to pair your phone with has the Bluetooth function activated and is made visible.*

#### ***To pair the phone with a device***

- 1 From standby select **Menu > Settings > the Connectivity tab > Bluetooth > My Devices > New Device** to search for available devices.
- 2 Select a device.
- 3 Enter a passcode, if required.

#### ***To allow connection to the phone***

- 1 From standby select **Menu > Settings > the Connectivity tab > Bluetooth > My Devices.**
- 2 Select a device from the list.
- 3 Select **More > Allow Connection.**

#### ***To pair the phone with a Bluetooth handsfree for the first time***

- 1 From standby select **Menu > Settings > the Connectivity tab > Bluetooth > Handsfree.**
- 2 Select **Yes.**
- 3 Enter a passcode, if required.

#### ***To pair the phone with more than one Bluetooth handsfree***

- 1 From standby select **Menu > Settings > the Connectivity tab > Bluetooth > Handsfree > My Handsfree > New Handsfree.**
- 2 Scroll to a device and select **Add.**

#### **Power save**

You can save battery power with this function. You can only connect with a single Bluetooth device. You must turn this function off if you want to connect with more than one Bluetooth device at the same time.

#### ***To turn powersave on***

- From standby select **Menu > Settings > the Connectivity tab > Bluetooth > Powersave > On.**

## Phone name

You can enter a name for your phone to be shown when other devices find it.

### *To enter a phone name*

- 1 From standby select **Menu > Settings > the Connectivity tab > Bluetooth > Phone Name.**
- 2 Enter the phone name and select **OK.**

## Visibility

If you want other Bluetooth devices to be able to discover your phone, you can choose to make your phone visible.

### *To show your phone*

- From standby select **Menu > Settings > the Connectivity tab > Bluetooth > Visibility > Show Phone.**

## Exchanging items

Send or receive items using Bluetooth wireless technology as the transfer method. Choose a device from the list of found devices.

### *To send a contact*

- 1 From standby select **Menu > Contacts.**
- 2 Scroll to a contact and select **More > Send Contact > Via Bluetooth.**
- 3 Select the device to send the item to.

### *To receive an item*

- 1 From standby select **Menu > Settings > the Connectivity tab > Bluetooth > Turn On.**
- 2 Select **Visibility > Show Phone.**
- 3 When you receive an item, follow the instructions on the screen.

## Transferring sound to and from a Bluetooth handsfree

You can transfer the sound to and from a Bluetooth handsfree. To do this, you can use a phone key or the handsfree key.

### *To transfer sound*

- 1 From standby select **Menu > Settings > the Connectivity tab > Bluetooth > Handsfree > Incoming Call.**
- 2 Select an option. In **Phone** transfers sound to the phone. In **Handsfree** transfers sound to the handsfree.

## File transfer

You can synchronize and transfer files using Bluetooth wireless technology. See *Synchronization using a computer* on page 51.

## Using the USB Cable

You can connect your phone to a computer with the USB cable to transfer files using **File Transfer** and you can synchronize your phone with a computer using **Phone Mode**.

### Before you use the USB cable

You need one of these operating systems to transfer files using a USB cable:

- Windows 2000 with SP3/SP4
- Windows XP (Pro and Home) with SP1/SP2
- Windows Vista™ (32 bit and 64 bit versions of: Ultimate, Enterprise, Business, Home Premium, Home Basic)

### File transfer

You can drag and drop files between your phone or memory card and a computer in *Microsoft Windows Explorer*.

- ! *Only use a USB cable supported by your phone. Do not remove the USB cable from your phone or computer during file transfer as this may corrupt the phone memory or the memory card.*

### To use file transfer mode

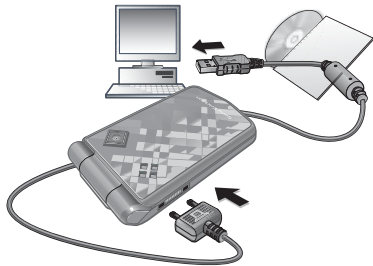

- 1 Connect the USB cable to the phone and the computer.
- 2 **Phone:** Select **File Transfer**. The phone shuts down.
- 3 Wait until the phone memory and memory card appear as external disks in *Windows Explorer*.

### To disconnect the USB cable safely

- 1 Right-click the removable disk icon in *Windows Explorer*.
- 2 Select *Eject*.
- 3 Remove the USB cable.

### Phone mode

You can synchronize contacts and calendar, transfer files and use your phone as a modem from your computer.

Supported applications in phone mode include:

- Synchronization
- File manager
- Mobile Networking Wizard

 *Before using phone mode you must install the Sony Ericsson PC Suite software on your computer. See To install the Sony Ericsson PC Suite on page 50.*

### *To use phone mode*

- 1 **Computer:** Start *PC Suite* from *Start/Programs/Sony Ericsson/PC Suite*.
- 2 Connect the USB cable to the phone and the computer.
- 3 **Phone:** Select **Phone Mode**.
- 4 **Computer:** When you are notified that *the Sony Ericsson PC Suite* has found your phone, you can start using the phone mode applications.

 *For usage details, see the Sony Ericsson PC Suite Help section once the software has been installed on your computer.*

## **PC Suite**

You need one of these operating systems to use the PC Suite on your computer:

- Windows XP (Pro and Home) with SP1/SP2
- Windows Vista (32 bit and 64 bit versions of: Ultimate, Enterprise, Business, Home Premium, Home Basic)

### *To install the Sony Ericsson PC Suite*

- Download and install Sony Ericsson PC Suite software from [www.sonyericsson.com/support](http://www.sonyericsson.com/support). The software includes help information.

## **Synchronizing**

You can use the USB cable or Bluetooth wireless technology to synchronize phone contacts, appointments, tasks and notes with a computer program such as Microsoft Outlook®. For more information go to the Getting started section at [www.sonyericsson.com/support](http://www.sonyericsson.com/support).

 *Use only one of the synchronization methods at a time with your phone.*

## Synchronization using a computer

Before synchronizing you need to install *the Sony Ericsson PC Suite*. Go to [www.sonyericsson.com/support](http://www.sonyericsson.com/support) to download the software. The software includes help information.

## Remote synchronization using Internet

You can synchronize online using an Internet service. If Internet settings are not in your phone, see *Settings* on page 44.

### Before you start to synchronize

You must enter settings for remote synchronization and register a synchronization account online. Settings that are required are:

- **Server Address** – server URL.
- **Username** – account username.
- **Password** – account password.
- **Connection** – select an Internet profile.
- **Applications** – mark applications to synchronize.
- **App. Settings** – select an application and enter a database name, and if required, username and password.
- **Sync. Interval** – set how often to synchronize.

- **Remote Initiation** – select an option to use when you start synchronization from a service.
- **Remote Security** – enter a server ID and a server password.

### To enter settings for remote synchronization

- 1 From standby select **Menu > Organizer > Synchronization > Yes**.
- 2 Enter a name for the new account and select **Continue**.
- 3 Enter the settings and select **Save**.

### To start remote synchronization

- 1 From standby select **Menu > Organizer > Synchronization**.
- 2 Scroll to an account and select **Start**.



## Update Service

You can update your phone with the latest software. You do not lose personal or phone information.

There are two ways to update your phone:

- Over the air using your phone
- Using a USB cable and an Internet-connected computer



*The update service requires data access (GPRS).*

Before you use the Update service  
If settings are not in your phone, see  
*Settings* on page 44.

*To view the current software in the phone*

- 1 From standby select **Menu > Settings**  
> the **General** tab > **Update Service**.
- 2 Select **Software Version**.

*To use Update service using the phone*

- 1 From standby select **Menu > Settings**  
> the **General** tab > **Update Service**.
- 2 Select **Search For Update** and follow  
the instructions on the screen.

*To use Update service using a USB cable*

- 1 Go to [www.sonyericsson.com/support](http://www.sonyericsson.com/support).
- 2 Select a region and country.
- 3 Enter the product name.
- 4 Select **Sony Ericsson Update Service**  
and follow the instructions on the  
screen.

*To set a reminder to use Update service*

- 1 From standby select **Menu > Settings**  
> the **General** tab > **Update Service**  
> **Reminder**.
- 2 Select an option.

## More Features

### Gesture Control

With gesture control you can silence  
incoming calls or snooze the alarm  
without touching the phone.

- ! *Wait for the gesture control light to  
flash before you sweep your hand  
back and forth.*

*To silence incoming calls*

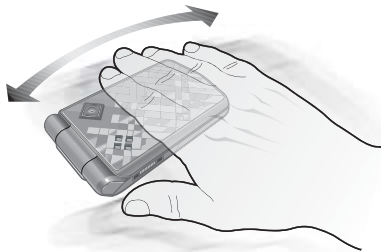

- When the phone rings, sweep your  
hand back and forth once in front of  
the camera lens.
- ! *The distance between your hand and the  
camera lens must be 0-3 inches (0-7 cm).*

### *To snooze the alarm*

- When the alarm sounds, sweep your hand back and forth once in front of the camera lens.

! *The distance between your hand and the camera lens must be 0-3 inches (0-7 cm).*

### *To turn gesture control on*

- From standby select **Menu**  
> **Settings** > the **General** tab  
> **Gesture control** > **On**.

## Alarms

You can set a sound or the radio as an alarm signal. The alarm sounds even if the phone is set to silent or turned off. When the alarm sounds you can silence it for 9 minutes or turn it off.

### *To set the alarm*

- 1 From standby select **Menu** > **Organizer** > **Alarms**.
- 2 Scroll to an alarm and select **Edit**.
- 3 Scroll to **Time:** and select **Edit**.
- 4 Enter a time and select **OK** > **Save**.

### *To set the recurring alarm*

- 1 From standby select **Menu** > **Organizer** > **Alarms**.
- 2 Scroll to an alarm and select **Edit**.
- 3 Scroll to **Recurrent:** and select **Edit**.
- 4 Scroll to a day and select **Mark**.
- 5 Select **Done** > **Save**.

### *To set the alarm signal*

- 1 From standby select **Menu** > **Organizer** > **Alarms**.
- 2 Scroll to an alarm and select **Edit**.
- 3 Scroll to **Alarm Signal:** and select **Edit**.
- 4 Scroll to an option and select **Save**.

### *To silence the alarm*

- When the alarm sounds, press any key.

### *To silence the radio alarm*

- When the alarm sounds, select **Snooze**.

### *To turn off an alarm*

- When the alarm sounds, select **Turn Off**.

### *To cancel the alarm*

- 1 From standby select **Menu** > **Organizer** > **Alarms**.
- 2 Scroll to an alarm and select **Turn Off**.

## Calendar

The calendar can be synchronized with a computer calendar or with a calendar on the Web. See *Synchronizing* on page 50.

## Appointments

You can add new appointments or reuse existing appointments.

### *To add an appointment*

- 1 From standby select **Menu > Organizer > Calendar**.
- 2 Select a date.
- 3 Scroll to **New Appointment** and select **Add**.
- 4 Enter the information and confirm each entry.
- 5 Select **Save**.

### *To view an appointment*

- 1 From standby select **Menu > Organizer > Calendar**.
- 2 Select a date.
- 3 Scroll to an appointment and select **View**.

### *To reuse an existing appointment*

- 1 From standby select **Menu > Organizer > Calendar**.
- 2 Select a date.
- 3 Scroll to an appointment and select **View**.
- 4 Select **More > Edit**.
- 5 Edit the appointment and confirm each entry.
- 6 Select **Save**.

### *To send an appointment*

- 1 From standby select **Menu > Organizer > Calendar**.
  - 2 Select a date.
  - 3 Scroll to an appointment and select **More > Send**.
  - 4 Select a transfer method.
- ! *Make sure the receiving device supports the transfer method you select.*

### *To view a calendar week*

- 1 From standby select **Menu > Organizer > Calendar**.
- 2 Select a date.
- 3 Select **More > View Week**.

### *To set when reminders should sound*

- 1 From standby select **Menu > Organizer > Calendar**.
  - 2 Select a date.
  - 3 Select **More > Advanced > Reminders**.
  - 4 Select an option.
- ! *A reminders option set in calendar affects a reminders option set in tasks.*

### **Navigating your calendar**

You can use the navigation key to move between days or weeks. In the monthly view, you can use keypad shortcuts.



Key	Shortcut
	Back a week
	Back a month
	Back a year
	Today's date
	Next week
	Next month
	Next year

## Calendar settings

### *To view calendar options*

- 1 From standby select **Menu** > **Organizer** > **Calendar**.
- 2 Select **More**.

## Tasks

You can add new tasks or reuse existing tasks.

### *To add a task*

- 1 From standby select **Menu** > **Organizer** > **Tasks**.
- 2 Select **New Task** > **Add**.
- 3 Select an option.
- 4 Enter details and confirm each entry.

### *To view a task*

- 1 From standby select **Menu** > **Organizer** > **Tasks**.
- 2 Scroll to a task and select **View**.

### *To reuse an existing task*

- 1 From standby select **Menu** > **Organizer** > **Tasks**.
- 2 Scroll to a task and select **View**.
- 3 Select **More** > **Edit**.
- 4 Edit the task and select **Continue**.
- 5 Choose to set a reminder.

### *To send a task*

- 1 From standby select **Menu** > **Organizer** > **Tasks**.
- 2 Scroll to a task and select **More** > **Send**.
- 3 Select a transfer method.

! *Make sure the receiving device supports the transfer method you select.*

### *To set when reminders should sound*

- 1 From standby select **Menu** > **Organizer** > **Tasks**.
- 2 Scroll to a task and select **More** > **Reminders**.
- 3 Select an option.

! *A reminders option set in tasks affects a reminders option set in calendar.*

## Notes

You can make notes and save them. You can also show a note in standby.

### *To add a note*

- 1 From standby select **Menu > Organizer > Notes.**
- 2 Select **New Note > Add.**
- 3 Write a note and select **Save.**

### *To show a note in standby*

- 1 From standby select **Menu > Organizer > Notes.**
- 2 Scroll to a note and select **More > Show in Standby.**

### *To edit a note*

- 1 From standby select **Menu > Organizer > Notes.**
- 2 Scroll to a note and select **More > Edit.**
- 3 Edit the note and select **Save.**

### *To send a note*

- 1 From standby select **Menu > Organizer > Notes.**
- 2 Scroll to a note and select **More > Send.**
- 3 Select a transfer method.

 *Make sure the receiving device supports the transfer method you select.*

## Timer, Stopwatch and Calculator



### *To use the timer*

- 1 From standby select **Menu > Organizer > Timer.**
- 2 Enter the hours, minutes and seconds.
- 3 Select **Start.**

### *To use the stopwatch*

- 1 From standby select **Menu > Organizer > Stopwatch > Start.**
- 2 To view a new lap time, select **New Lap.**

### *To use the calculator*

- 1 From standby select **Menu > Organizer > Calculator.**
- 2 Press  or  to select  $\div$   $\times$   $-$   $+$   $.$   $\%$   $=$ .

## Code Memo

You can save security codes, for example, for credit cards. You must set a passcode to open the code memo.

### Checkword

The checkword confirms that you have entered the correct passcode. If the passcode is correct, the correct codes are shown. If the passcode is incorrect, the checkword and the codes shown are also incorrect.

### *To open code memo for the first time*

- 1 From standby select **Menu > Organizer > Code Memo**.
- 2 Follow the instructions on the screen and select **Continue**.
- 3 Enter a passcode and select **Continue**.
- 4 Confirm the passcode and select **Continue**.
- 5 Enter a checkword and select **Done**.

### *To add a code*

- 1 From standby select **Menu > Organizer > Code Memo**.
- 2 Enter a passcode and select **New Code > Add**.
- 3 Enter a name associated with the code and select **Continue**.
- 4 Enter the code and select **Done**.

### *To change a passcode*

- 1 From standby select **Menu > Organizer > Code Memo**.
- 2 Enter your passcode and select **More > Change Passcode**.
- 3 Enter your new passcode and select **Continue**.
- 4 Re-enter the new passcode and select **Continue**.
- 5 Enter a checkword and select **Done**.

### **Forget your passcode?**

If you forget your passcode, you must reset the code memo. This means that all entries in the code memo are deleted. The next time you enter the code memo, you must proceed as if you are opening it for the first time. See *To open code memo for the first time* on page 57.

### *To reset code memo*

- 1 From standby select **Menu > Organizer > Code Memo**.
- 2 Enter any passcode to access the code memo. The checkword and codes that are then shown are incorrect.
- 3 Select **More > Reset**.
- 4 **Reset code memo?** appears.
- 5 Select **Yes**.

## **Profiles**

Profiles automatically adapt your phone to different situations, for example, while in a meeting or when driving. Some profiles settings, for example, ring volume may be adjusted automatically to suit a certain area or accessory. You can reset all profile settings to how they were set when you bought your phone.

### *To select a profile*

- 1 From standby select **Menu > Settings > the General tab > Profiles.**
- 2 Select a profile.

### *To view and edit a profile*

- 1 From standby select **Menu > Settings > the General tab > Profiles.**
- 2 Scroll to a profile and select **More > View And Edit.**



*You cannot rename the Normal profile.*

### *To reset all profiles*

- 1 From standby select **Menu > Settings > the General tab > Profiles.**
- 2 Scroll to a profile and select **More > Reset Profiles.**

## Time and Date

### *To set the time*

- 1 From standby select **Menu > Settings > the General tab > Time & Date > Time.**
- 2 Enter the time and select **Save.**

### *To set the date*

- 1 From standby select **Menu > Settings > the General tab > Time & Date > Date.**
- 2 Enter the date and select **Save.**

## Themes

You can change the appearance of the screen through items such as colors and wallpaper. You can also create new themes and download them. For more information, go to [www.sonyericsson.com/support](http://www.sonyericsson.com/support).

### *To set a theme*

- 1 From standby select **Menu > File Manager > Themes.**
- 2 Scroll to a theme and select **Set.**

## Locks

### **SIM card lock**

This lock only protects your subscription. Your phone will work with a new SIM card. If the lock is on, you have to enter a PIN (Personal Identity Number).

If you enter your PIN incorrectly three times in a row, the SIM card is blocked and you need to enter your PUK (Personal Unblocking Key). Your PIN and PUK are supplied by your network operator.

### *To unblock the SIM card*

- 1 When **PIN Blocked** appears, enter your PUK and select **OK.**
- 2 Enter a new four-to-eight-digit PIN and select **OK.**
- 3 Re-enter the new PIN and select **OK.**

### To edit the PIN

- 1 From standby select **Menu > Settings > the General tab > Security > Locks > SIM Protection > Change PIN.**
- 2 Enter your PIN and select **OK.**
- 3 Enter a new four-to-eight-digit PIN and select **OK.**
- 4 Re-enter the new PIN and select **OK.**

! *If Codes do not match. appears, you entered the new PIN incorrectly. If Wrong PIN. appears, followed by Old PIN:, you entered your old PIN incorrectly.*

### To use the SIM card lock

- 1 From standby select **Menu > Settings > the General tab > Security > Locks > SIM Protection > Protection.**
- 2 Select an option.
- 3 Enter your PIN and select **OK.**

### Phone lock

You can stop unauthorized use of your phone. Change the phone lock code (0000) to any four-to-eight-digit personal code.

! *It is important that you remember your new code. If you forget it, you have to take your phone to your local Sony Ericsson retailer.*

### To use the phone lock

- 1 From standby select **Menu > Settings > the General tab > Security > Locks > Phone Protection > Protection.**
- 2 Select an option.
- 3 Enter the phone lock code and select **OK.**

### To change the phone lock code

- 1 From standby select **Menu > Settings > the General tab > Security > Locks > Phone Protection > Change Code.**
- 2 Enter the old code and select **OK.**
- 3 Enter the new code and select **OK.**
- 4 Repeat the code and select **OK.**

### IMEI Number

Keep a copy of your IMEI (International Mobile Equipment Identity) number in case your phone should be stolen.

### To view your IMEI number

- From standby press **\*#06#**, **#\*#06#**, **0+** , **6** , **#\*#06#**.

# Troubleshooting

## *Why doesn't the phone work the way I want it to?*

Some problems will require you to call your network operator.

For more support go to [www.sonyericsson.com/support](http://www.sonyericsson.com/support).

## Common Questions

### *I have problems with memory capacity or the phone is working slowly*

Restart your phone every day to free memory or do a **Master Reset**.

### **Master reset**

If you select **Reset Settings**, the changes that you have made to settings will be deleted.

If you select **Reset All**, in addition to your changes to settings, all contacts, messages, personal data, and content that you have downloaded, received or edited will also be deleted.

### *To reset the phone*

- 1 From standby select **Menu > Settings > the General tab > Master Reset > Reset Settings**.
- 2 Follow the instructions on the screen and select **Continue**.

### *I cannot charge the phone or battery capacity is low*

The charger is not properly connected or the battery connection is poor. Remove the battery and clean the connectors.

The battery is worn out and needs to be replaced. See *Charging the Battery* on page 8.

### *No battery icon appears when I start charging the phone*

It may take a few minutes before the battery icon appears on the screen.

### *Some menu options appear in gray*

A service is not activated. Contact your network operator.

### *I cannot use SMS/text messages on my phone*

Settings are missing or incorrect. Contact your network operator to find out the correct SMS service center setting. See *Text Messages* on page 27.

### *I cannot use picture messages on my phone*

Your subscription does not include data capability. Settings are missing or incorrect. Please contact your network operator.

See *Help in your Phone* on page 7 or go to [www.sonyericsson.com/support](http://www.sonyericsson.com/support) to order settings and follow the instructions on the screen. See *Settings* on page 44.

### ***How do I turn on and off T9 text input when writing a text message?***

When you enter text, press and hold down  You will see “T9” at the top of the text message when T9 is activated.

### ***How do I change phone language?***

- 1 From standby select **Menu > Settings > the General tab > Language > Phone Language.**
- 2 Select an option.

### ***I cannot use the Internet***

Your subscription does not include data capability. Internet settings are missing or incorrect. Please contact your network operator.

See *Help in your Phone* on page 7 or go to [www.sonyericsson.com/support](http://www.sonyericsson.com/support) to order Internet settings and follow the instructions on the screen. See *Settings* on page 44.

### ***The phone cannot be detected by other devices using Bluetooth wireless technology***

You have not turned the Bluetooth function on.

Make sure that the visibility is set to show phone. See *To receive an item* on page 48.

### ***I cannot synchronize or transfer data between my phone and my computer, when using the USB cable.***

The cable or software that came with your phone has not been properly installed. Go to [www.sonyericsson.com/support](http://www.sonyericsson.com/support), to read Getting started guides which contain detailed installation instructions and troubleshooting guides.

## **Error Messages**

### **Insert SIM.**

There is no SIM card in your phone or you may have inserted it incorrectly.

See *Charging the Battery* on page 8.

The SIM card connectors need cleaning. If the card is damaged, contact your network operator.

### **Insert correct SIM card.**

Your phone is set to work only with certain SIM cards. Check if you are using the correct operator SIM card.

### **Wrong PIN./Wrong PIN2.**

You have entered your PIN or PIN2 incorrectly.

Enter the correct PIN or PIN2 and select **Yes**. See *To insert the SIM card* on page 5.

### **PIN Blocked/PIN2 blocked.**

You have entered your PIN or PIN2 code incorrectly three times in a row.

To unblock, see *SIM card lock* on page 58.

### **Codes do not match.**

Codes that you have entered do not match. When you want to change a security code, for example your PIN, you have to confirm the new code. See *SIM card lock* on page 58.

### **No Nwk Coverage**

Your phone is not receiving any radio signal, or the received signal is too weak. Contact your network operator and make sure that the network has coverage where you are.

The SIM card is not working properly. Insert your SIM card in another phone. If this works, it is probably your phone that is causing the problem. Please contact the nearest Sony Ericsson service location.

### **Emerg. Calls Only**

You are within range of a network, but you are not allowed to use it. However, in an emergency, some network operators allow you to call the international emergency number 112. See *Emergency Calls* on page 19.

### **PUK blocked. Contact provider.**

You entered your personal unblocking key code (PUK) incorrectly 10 times in a row.

### **Charging - Non-standard battery.**

The battery that you are using is not a Sony Ericsson-approved battery. See *Battery* on page 66.



# Important Information

## Sony Ericsson Consumer Web site

On [www.sonyericsson.com/support](http://www.sonyericsson.com/support) is a support section where help and tips are only a few clicks away. Here you will find the latest computer software updates and tips on how to use your product more efficiently.

## Service and support

From now on you will have access to a portfolio of exclusive service advantages such as:

- Global and local Web sites providing support.
- A global network of Call Centers.
- An extensive network of Sony Ericsson service partners.
- A warranty period. Learn more about the warranty conditions in this User guide.

## Support

Argentina	800-333-7427
Australia	1-300650-600
Belgique/België	02-7451611
Brazil	4001-04444
Canada	1-866-766-9374
Central Africa	+27 112589023
Chile	123-0020-0656
Colombia	18009122135
Česká republika	844550 055
Danmark	33 31 28 28
Deutschland	0180 534 2020
Ελλάδα	801-11-810-810 210-89 91 919
España	902 180 576

On [www.sonyericsson.com](http://www.sonyericsson.com), under the support section in the language of your choice, you will find the latest support tools and information, such as software updates, Knowledge base, phone setup and additional help when you require it. For operator-specific services and features, please contact your network operator for more information.

You can also contact our Call Centers. See the phone number for the nearest Call Center in the list below. If your country/region is not represented in the list, please contact your local dealer. (The phone numbers below were correct at the time of going to print. On [www.sonyericsson.com](http://www.sonyericsson.com) you can always find the latest updates).

In the unlikely event that your product needs service please contact the dealer from whom it was purchased or one of our service partners. Save your original proof of purchase, you will need it if you need to claim warranty.

For a call to one of our Call Centers you will be charged according to national rates, including local taxes, unless the phone number is a toll-free number.

questions.AR@support.sonyericsson.com
questions.AU@support.sonyericsson.com
questions.BE@support.sonyericsson.com
questions.BR@support.sonyericsson.com
questions.CA@support.sonyericsson.com
questions.CF@support.sonyericsson.com
questions.CL@support.sonyericsson.com
questions.CO@support.sonyericsson.com
questions.CZ@support.sonyericsson.com
questions.DK@support.sonyericsson.com
questions.DE@support.sonyericsson.com
questions.GR@support.sonyericsson.com
questions.ES@support.sonyericsson.com

France	0 825 383 383	questions.FR@support.sonyericsson.com
Hong Kong/香港	8203 8863	questions.HK@support.sonyericsson.com
Hrvatska	062 000 000	questions.HR@support.sonyericsson.com
India/ भारत	39011111	questions.IN@support.sonyericsson.com
Indonesia	021-2701388	questions.ID@support.sonyericsson.com
Ireland	1850 545 888	questions.IE@support.sonyericsson.com
Italia	06 48895206	questions.IT@support.sonyericsson.com
Lietuva	8 70055030	questions.LT@support.sonyericsson.com
Magyarország	+36 1 880 4747	questions.HU@support.sonyericsson.com
Malaysia	1-800-889900	questions.MY@support.sonyericsson.com
México	01 800 000 4722	questions.MX@support.sonyericsson.com
Nederland	0900 899 8318	questions.NL@support.sonyericsson.com
New Zealand	0800-100150	questions.NZ@support.sonyericsson.com
Norge	815 00 840	questions.NO@support.sonyericsson.com
Österreich	0810 200245	questions.AT@support.sonyericsson.com
Pakistan	111 22 55 73 (92-21) 111 22 55 73	questions.PK@support.sonyericsson.com
Philippines/Pilipinas	02-6351860	questions.PH@support.sonyericsson.com
Polska	0 (prefiks) 22 6916200	questions.PL@support.sonyericsson.com
Portugal	808 204 466	questions.PT@support.sonyericsson.com
România	(+4021) 401 0401	questions.RO@support.sonyericsson.com
Россия	8 (495) 787 0986	questions.RU@support.sonyericsson.com
Schweiz/Suisse/Svizzera	0848 824 040	questions.CH@support.sonyericsson.com
Singapore	67440733	questions.SG@support.sonyericsson.com
Slovensko	02-5443 6443	questions.SK@support.sonyericsson.com
South Africa	0861 6322222	questions.ZA@support.sonyericsson.com
Suomi	09-299 2000	questions.FI@support.sonyericsson.com
Sverige	013-24 45 00	questions.SE@support.sonyericsson.com
Türkiye	0212 473 77 71	questions.TR@support.sonyericsson.com
Україна	(+0380) 44 590 1515	questions.UA@support.sonyericsson.com
United Kingdom	08705 23 7237	questions.GB@support.sonyericsson.com
United States	1-866-7669347	questions.US@support.sonyericsson.com
Venezuela	0-800-100-2250	questions.VE@support.sonyericsson.com
الإمارات العربية المتحدة	43 919880	questions.AE@support.sonyericsson.com
中国	4008100000	questions.CN@support.sonyericsson.com
台灣	02-2562511	questions.TW@support.sonyericsson.com
ไทย	02-2483030	questions.TH@support.sonyericsson.com

## Guidelines for Safe and Efficient Use

Please read this information before using your phone.

These instructions are intended for your safety. Please follow these guidelines. If the product has been subject to any of the conditions listed below or you have any doubt as to its proper function make sure you have the product checked by a certified service partner before charging or using it. Failure to do so might entail a risk of product malfunction or even a potential hazard to your health.



### Recommendations for safe use of product (phone, battery, charger and other accessories)

- Always treat your product with care and keep it in a clean and dust-free place.
- **Warning!** May explode if disposed of in fire.
- Do not expose your product to liquid or moisture or humidity.
- Do not expose your product to extremely high or low temperatures. Do not expose the battery to temperatures above +140°F (+60°C).
- Do not expose your product to open flames or lit tobacco products.
- Do not drop, throw or try to bend your product.
- Do not paint your product.
- Do not attempt to disassemble or modify your product. Only Sony Ericsson authorized personnel should perform service.
- Do not close your product with an object inserted between keypad and display; this may damage your product.



- Do not use your product near medical equipment without requesting permission from your treating physician or authorized medical staff.
- Do not use your product when in, or around aircraft, or areas showing the sign "turn off two-way radio".
- Do not use your product in an area where a potentially explosive atmosphere exists.
- Do not place your product or install wireless equipment in the area above an air bag in your car.
- **Caution:** Cracked or broken displays may create sharp edges or splinters that could be harmful upon contact.



### CHILDREN

KEEP OUT OF CHILDREN'S REACH. DO NOT ALLOW CHILDREN TO PLAY WITH YOUR PHONE OR ITS ACCESSORIES. THEY COULD HURT THEMSELVES OR OTHERS, OR COULD ACCIDENTALLY DAMAGE THE PHONE OR ACCESSORY. YOUR PHONE OR ITS ACCESSORY MAY CONTAIN SMALL PARTS THAT COULD BECOME DETACHED AND CREATE A CHOKING HAZARD.



### Power supply (Charger)

Connect the AC power adapter only to designated power sources as marked on the product. Make sure the cord is positioned so that it will not be subjected to damage or stress. To reduce risk of electric shock, unplug the unit from any power source before attempting to clean it. The AC power adapter must not be used outdoors or in damp areas. Never alter the cord or plug. If the plug does not fit into the outlet, have a proper outlet installed by a qualified electrician.

Use only Sony Ericsson branded original chargers intended for use with your phone. Other chargers may not be designed to the same safety and performance standards.

## Battery

We recommend that you fully charge the battery before you use your phone for the first time. A new battery or one that has not been used for a long time could have reduced capacity the first few times it is used. The battery should only be charged in temperatures between +41°F (+5°C) and +113°F (+45°C).

Use only Sony Ericsson branded original batteries intended for use with your phone. Using other batteries and chargers could be dangerous.

Talk and standby times depend on several different conditions such as signal strength, operating temperature, application usage patterns, features selected and voice or data transmissions when the phone is being used.

Turn off your phone before removing the battery. Do not put the battery into your mouth. Battery electrolytes may be toxic if swallowed. Do not let the metal contacts on the battery touch another metal object. Doing this could short-circuit and damage the battery. Use the battery for the intended purpose only.

## Personal medical devices

Phones may affect the operation of pacemakers and other implanted equipment. Please avoid placing the phone over the pacemaker, for example in your breast pocket. When using the phone, use it at the ear on the opposite side of the body to the pacemaker. If a minimum distance of 6 inches (15 cm) is kept between the phone and the pacemaker, the risk of interference is limited. If you have any reason to suspect that interference is taking place, immediately turn off your phone. Contact your cardiologist for more information.

For other medical devices, please consult your physician and the manufacturer of the device.

## Driving

Please check if local laws and regulations restrict the use of phones while driving or require drivers to use handsfree solutions. We recommend that you use only Sony Ericsson handsfree solutions intended for use with your product.

Please note that because of possible interference to electronic equipment, some vehicle manufacturers forbid the use of phones in their vehicles unless a handsfree kit with an external antenna has been installed.

Always pay full attention to driving and pull off the road and park before making or answering a call if driving conditions so require.

## GPS/Location based functions

Some products provide GPS/Location based functions. Location determining functionality is provided "AS IS" and "WITH ALL FAULTS". Sony Ericsson does not make any representation or warranty as to the accuracy of such location information. Use of location-based information by the device may not be uninterrupted or error free and may additionally be dependent on network service availability. Please note that functionality may be reduced or prevented in certain environments such as building interiors or areas adjacent to buildings. Caution: Do not use GPS functionality in a manner which causes distraction from driving.

## Emergency calls

Phones operate using radio signals, which cannot guarantee connection in all conditions. You should therefore never rely solely upon any phone for essential communications (for example medical emergencies). Emergency calls may not be possible in all areas, on all cellular networks, or when certain network services and/or phone features are in use. Check with your local service provider.

## Antenna

This phone contains a built-in antenna. Use of antenna devices not marketed by Sony Ericsson specifically for this model could damage your phone, reduce performance, and produce SAR levels above the established limits (see below).

## Efficient use

Hold your phone as you would any other phone. Do not cover the top of the phone when it is in use, as this affects call quality and may cause the phone to operate at a higher power level than needed, thus shortening talk and standby times.

## Radio frequency (RF) exposure and Specific Absorption Rate (SAR)

Your phone is a low-power radio transmitter and receiver. When it is turned on, it emits low levels of radio frequency energy (also known as radio waves or radio frequency fields).

Governments around the world have adopted comprehensive international safety guidelines, developed by scientific organizations, for example ICNIRP (International Commission on Non-Ionizing Radiation Protection) and IEEE (The Institute of Electrical and Electronics Engineers Inc.), through periodic and thorough evaluation of scientific studies. These guidelines establish permitted levels of radio wave exposure for the general population. The levels include a safety margin designed to assure the safety of all persons, regardless of age and health, and to account for any variations in measurements.

Specific Absorption Rate (SAR) is the unit of measurement for the amount of radio frequency energy absorbed by the body when using a phone. The SAR value is determined at the highest certified power level in laboratory conditions, but the actual SAR level of the phone while it is operating can be

well below this value. This is because the phone is designed to use the minimum power required to reach the network.

Variations in SAR below the radio frequency exposure guidelines do not mean that there are variations in safety. While there may be differences in SAR levels among phones, all Sony Ericsson phone models are designed to meet radio frequency exposure guidelines.

For phones sold in the US, before a phone model is available for sale to the public, it must be tested and certified by the Federal Communications Commission (FCC) that it does not exceed the limit established by the government-adopted requirement for safe exposure. The tests are performed in positions and locations (that is, at the ear and worn on the body) as required by the FCC for each model. For body-worn operation, this phone has been tested and meets FCC RF exposure guidelines when the handset is positioned a minimum of 15 mm from the body without any metal parts in the vicinity of the phone or when used with the original Sony Ericsson accessory intended for this phone and worn on the body. Use of other accessories may not ensure compliance with FCC RF exposure guidelines.

A separate leaflet with SAR information about this phone model is included with the material accompanying this phone. This information can also be found, together with more information on radio frequency exposure and SAR, on: [www.sonyericsson.com/health](http://www.sonyericsson.com/health).

## Accessible Solutions/Special Needs

For phones sold in the US, you can use your TTY terminal with your Sony Ericsson phone (with the necessary accessory). For information on Accessible Solutions for individuals with special needs call the Sony Ericsson Special Needs Center on 877 878 1996 (TTY) or 877 207 2056 (voice), or visit the Sony Ericsson Special Needs Center at [www.sonyericsson-snc.com](http://www.sonyericsson-snc.com).

## Disposal of old electrical and electronic equipment

This symbol indicates that all electrical and electronic equipment included shall not be treated as household waste. Instead it shall be left at the appropriate collection point for recycling of electrical and electronic equipment. By ensuring this product is disposed of correctly, you will help prevent potential negative consequences for the environment and human health, which could otherwise be caused by inappropriate waste handling of this product. The recycling of materials will help to conserve natural resources. For more detailed information about recycling this product, please contact your local city office, your household waste disposal service or the shop where you purchased the product.



## Disposing of the battery

Please check local regulations for disposal of batteries or call your local Sony Ericsson Call Center for information.

The battery should never be placed in municipal waste. Use a battery disposal facility if available.



## Memory card

If your product comes complete with a removable memory card, it is generally compatible with the handset purchased but may not be compatible with other devices or the capabilities of their memory cards. Check other devices for compatibility before purchase or use. If your product is equipped with a memory card reader, check memory card compatibility before purchase or use.

Memory cards are generally formatted prior to shipping. To reformat the memory card, use a compatible device. Do not use the standard operating system format when formatting the memory card on a PC. For details, refer to the operating instructions of the device or contact customer support.

## WARNING:

If your device requires an adapter for insertion into the handset or another device, do not insert the card directly without the required adapter.

## Precautions on Memory Card Use

- Do not expose the memory card to moisture.
- Do not touch terminal connections with your hand or any metal object.
- Do not strike, bend, or drop the memory card.
- Do not attempt to disassemble or modify the memory card.
- Do not use or store the memory card in humid or corrosive locations or in excessive heat such as a closed car in summer, in direct sunlight or near a heater, etc.
- Do not press or bend the end of the memory card adapter with excessive force.
- Do not let dirt, dust, or foreign objects get into the insert port of any memory card adapter.
- Check you have inserted the memory card correctly.
- Insert the memory card as far as it will go into any memory card adapter needed. The memory card may not operate properly unless fully inserted.
- We recommend that you make a backup copy of important data. We are not responsible for any loss or damage to content you store on the memory card.
- Recorded data may be damaged or lost when you remove the memory card or memory card adapter, turn off the power while formatting, reading or writing data, or use the memory card in locations subject to static electricity or high electrical field emissions.

## Protection of personal information

To safeguard your privacy and prevent information being accessible to a third party, you should erase all personal data before selling or disposing of the product. To delete personal data, perform a master reset, remove the memory card or format the media memory. **DELETION OF MATERIAL FROM THE**

PHONE AND MEDIA MEMORIES DOES NOT ENSURE THAT SAID INFORMATION CANNOT BE RECOVERED BY A SUBSEQUENT USER. SONY ERICSSON DOES NOT WARRANT AGAINST A SUBSEQUENT USER OF THE DEVICE ACCESSING YOUR INFORMATION AND DOES NOT ASSUME ANY RESPONSIBILITY FOR SUBSEQUENT DISCLOSURE OF SAID INFORMATION EVEN IF A MASTER RESET AND A MEDIA MEMORY FORMAT HAS BEEN PERFORMED. If you are concerned about such potential disclosure retain your device or secure its permanent destruction.

## Accessories

Sony Ericsson recommends use of Sony Ericsson original accessories for safe and efficient use of its products. Use of third-party accessories may decrease performance or pose a risk to your health or safety.

## LOUDNESS WARNING:

Please adjust the audio volume cautiously when using third-party audio accessories to avoid volume levels that may be harmful to your hearing. Sony Ericsson does not test use of third-party audio accessories with this phone. Sony Ericsson recommends using only Sony Ericsson original audio accessories.

## End User License Agreement

This wireless device, including without limitation any media delivered with the device, ("Device") contains software owned by Sony Ericsson Mobile Communications AB and its affiliated companies ("Sony Ericsson") and its third party suppliers and licensors ("Software").

As user of this Device, Sony Ericsson grants you a non-exclusive, non-transferable, non-assignable license to use the Software solely in conjunction with the Device on which it is installed and/or delivered with. Nothing herein shall be construed as a sale of the Software to a user of this Device.

You shall not reproduce, modify, distribute, reverse engineer, decompile, otherwise alter or use any other means to discover the source code of the Software or any component of the Software. For avoidance of doubt, you are at all times entitled to transfer all rights and obligations to the Software to a third party, solely together with the Device with which you received the Software, provided always that such third party agrees in writing to be bound by these rules.

You are granted this license for a term of the useful life of this Device. You can terminate this license by transferring all your rights to the Device on which you have received the Software to a third party in writing. If you fail to comply with any of the terms and conditions set out in this license, it will terminate with immediate effect.

Sony Ericsson and its third party suppliers and licensors are the sole and exclusive owner of and retain all rights, title and interest in and to the Software. Sony Ericsson, and, to the extent that the Software contains material or code of a third party, such third party, shall be entitled third party beneficiaries of these terms.

The validity, construction and performance of this license shall be governed by the laws of Sweden. The foregoing shall apply to the full extent permitted by, when applicable, statutory consumer rights.

## Limited Warranty

Sony Ericsson Mobile Communications AB, Nya Vattentornet, SE-221 88 Lund, Sweden, (Sony Ericsson) or its local affiliated company, provides this Limited Warranty for your phone and original accessory delivered with your phone (hereinafter referred to as "Product"). Should your Product need warranty service, please return it to the dealer from whom it was purchased, or contact your local Sony Ericsson Call Center (national rates may apply) or visit [www.sonyericsson.com](http://www.sonyericsson.com) to get further information.

## Our warranty

Subject to the conditions of this Limited Warranty, Sony Ericsson warrants this Product to be free from defects in design, material and workmanship at the time of its original purchase by a consumer. This Limited Warranty will last for a period of one (1) year as from the original date of purchase of the Product.

## What we will do

If, during the warranty period, this Product fails to operate under normal use and service, due to defects in design, materials or workmanship, Sony Ericsson authorized distributors or service partners, in the country\* where you purchased the Product, will, at their option, either repair or replace the Product in accordance with the terms and conditions stipulated herein.

Sony Ericsson and its service partners reserve the right to charge a handling fee if a returned Product is found not to be under warranty according to the conditions below.

Please note that some of your personal settings, downloads and other information may be lost when your Sony Ericsson Product is repaired or replaced. At present Sony Ericsson may be prevented by applicable law, other regulation or technical restrictions from making a backup copy of certain downloads. Sony Ericsson does not take any responsibility for any lost information of any kind and will not reimburse you for any such loss. You should always make backup copies of all the information stored on your Sony Ericsson Product such as downloads, calendar and contacts before handing in your Sony Ericsson Product for repair or replacement.

## Conditions

- 1 This Limited Warranty is valid only if the original proof of purchase for this Product issued by a Sony Ericsson authorized dealer specifying the date of purchase and serial number\*\*, is presented with the Product to be repaired or replaced. Sony Ericsson reserves the right to refuse warranty service if this information has been removed or changed after the original purchase of the Product from the dealer.
- 2 If Sony Ericsson repairs or replaces the Product, the repair for the defect concerned, or the replaced Product shall be warranted for the remaining time of the original warranty period or for ninety (90) days from the date of repair, whichever is longer. Repair or replacement may involve the use of functionally equivalent reconditioned units. Replaced parts or components will become the property of Sony Ericsson.
- 3 This warranty does not cover any failure of the Product due to normal tear and wear, or due to misuse, including but not limited to use in other than the normal and customary manner, in accordance with the Sony Ericsson instructions for use and maintenance of the Product. Nor does this warranty cover any failure of the Product due to accident, software or hardware modification or adjustment, acts of God or damage resulting from liquid. A rechargeable battery can be charged and discharged more than a hundred times. However, it will eventually wear out - this is not a defect and corresponds to normal wear and tear. When the talk-time or standby time is noticeably shorter, it is time to replace your battery. Sony Ericsson recommends that you use only batteries and chargers approved by Sony Ericsson.



Minor variations in display brightness and color may occur between the phones. There may be tiny bright or dark dots on the display. These are called defective pixels and occur when individual dots have malfunctioned and can not be adjusted. Two defective pixels are deemed acceptable.

Minor variations in camera image appearance may occur between phones. This is nothing uncommon and is not regarded as a defective camera module.

- 4 Since the cellular system on which the Product is to operate is provided by a carrier independent from Sony Ericsson, Sony Ericsson will not be responsible for the operation, availability, coverage, services or range of that system.
- 5 This warranty does not cover Product failures caused by installations, modifications, or repair or opening of the Product performed by a non-Sony Ericsson authorized person.
- 6 The warranty does not cover Product failures which have been caused by use of accessories or other peripheral devices which are not Sony Ericsson branded original accessories intended for use with the Product.
- 7 Tampering with any of the seals on the Product will void the warranty.
- 8 THERE ARE NO EXPRESS WARRANTIES, WHETHER WRITTEN OR ORAL, OTHER THAN THIS PRINTED LIMITED WARRANTY. ALL IMPLIED WARRANTIES, INCLUDING WITHOUT LIMITATION THE IMPLIED WARRANTIES OF MERCHANTABILITY OR FITNESS FOR A PARTICULAR PURPOSE, ARE LIMITED TO THE DURATION OF THIS LIMITED WARRANTY. IN NO EVENT SHALL SONY ERICSSON OR ITS LICENSORS BE LIABLE FOR INCIDENTAL OR CONSEQUENTIAL DAMAGES OF ANY NATURE WHATSOEVER, INCLUDING BUT NOT LIMITED TO LOST PROFITS OR COMMERCIAL LOSS; TO THE FULL EXTENT THOSE DAMAGES CAN BE DISCLAIMED BY LAW.

Some countries/states do not allow the exclusion or limitation of incidental or consequential damages, or limitation of the duration of implied warranties, so the preceding limitations or exclusions may not apply to you.

The warranty provided does not affect the consumer's statutory rights under applicable legislation in force, nor the consumer's rights against the dealer arising from their sales / purchase contract.

### \* Geographical scope of the warranty

If you have purchased your Product in a country member of the European Economic Area (EEA) or in Switzerland or the Republic of Turkey, and such Product was intended for sale in the EEA or in Switzerland or in Turkey, you can have your Product serviced in any EEA country or in Switzerland or in Turkey, under the warranty conditions prevailing in the country in which you require servicing, provided that an identical Product is sold in such country by an authorized Sony Ericsson distributor. To find out if your Product is sold in the country you are in, please call the local Sony Ericsson Call Center. Please observe that certain services may not be possible elsewhere than in the country of original purchase, for example due to the fact that your Product may have an interior or exterior which is different from equivalent models sold in other countries. Please note in addition that it may sometimes not be possible to repair SIM-locked Products.

\*\* In some countries/regions additional information (such as a valid warranty card) may be requested.

This Class B digital apparatus complies with Canadian ICES-003.

Cet appareil numérique de la classe B est conforme à la norme NMB-003 du Canada.

This device complies with RSS-210 of Industry Canada.

Operation is subject to the following two conditions:

- (1) this device may not cause interference, and
- (2) this device must accept any interference, including interference that may cause undesired operation of the device.

## Declaration of Conformity for Z555a

We, Sony Ericsson Mobile Communications AB of Nya Vattentorget SE-221 88 Lund, Sweden declare under our sole responsibility that our product Sony Ericsson type AAB-1032052-BV and in combination with our accessories, to which this declaration relates is in conformity with the appropriate standards EN 301511:V9.0.2, EN 301489-7:V1.3.1, EN 301489-17:V1.2.1, EN 300328:V1.7.1 and EN 60950-1:2006, following the provisions of, Radio Equipment and Telecommunication Terminal Equipment directive 99/5/EC.

Lund, December 2007

**CE 0682**



---

Shoji Nemoto,

*Head of Product Business Group GSM/UMTS*

We fulfill the requirements of the R&TTE Directive (99/5/EC).

# Index

## A

activity menu .....	15
alarms .....	53
answering service .....	23
applications .....	43
appointments .....	53
assembly .....	5
automatic redialing .....	19

## B

battery	
charging .....	8
inserting .....	5
use and care .....	66
Bluetooth™ wireless technology .....	46
business cards .....	27
buttons .....	9, 13

## C

calculator .....	56
calendar .....	53
call forward .....	23
call list .....	22
call numbers in message .....	28
call time .....	26
caller-specific ringtones .....	20

## calls

accepting .....	25
answering .....	7, 19
handling two calls .....	24
international .....	19
making .....	7, 19
putting on hold .....	24
re-dialing .....	19
rejecting .....	7, 19

## camera

overview .....	36
settings .....	37

code memo .....	56
conference calls .....	25

## contacts

adding phone contacts .....	20
default contacts .....	20
groups of .....	22
synchronizing .....	50

## D

date .....	58
declaration of conformity .....	72
downloading files .....	46

<b>E</b>		<b>J</b>	
email .....	31	Java™ .....	43
emergency calls .....	19	<b>K</b>	
entering text		keys .....	9, 13
multitap .....	18	<b>L</b>	
T9™ Text Input .....	18	lock	
error messages .....	61	phone .....	59
<b>F</b>		SIM card .....	58
file manager .....	15	<b>M</b>	
fixed dialing .....	26	master reset .....	60
<b>G</b>		Media Manager .....	39
games .....	43	memory card .....	15
gesture control .....	52	memory status .....	22
groups .....	22	menu overview .....	11
<b>H</b>		menus .....	13
handsfree .....	39	message templates .....	30
Bluetooth technology .....	47	messages .....	27
help .....	7	area and cell information .....	35
<b>I</b>		email .....	31
IMEI number .....	59	picture message .....	29
Internet		templates .....	30
bookmarks .....	45	text message .....	27
profiles .....	46	voice .....	31
security and certificates .....	46	microphone .....	19
settings .....	44		

music	
transferring .....	39
MusicDJ™ .....	42
My friends .....	34
my numbers .....	25

## N

navigating menus .....	13
notes .....	55

## P

PC Suite .....	50
phone	
language .....	17
lock .....	59
phone overview .....	9
picture message .....	29
pictures .....	38
PIN code	
changing .....	59
PlayNow™ .....	40
profiles .....	57
PUK .....	58
push email .....	33

## R

radio .....	40
restricted calls .....	26
ringtones .....	41
RSS reader .....	46

## S

safety guidelines .....	65
sending	
business cards .....	27
melodies and ringtones .....	42
pictures .....	38
settings	
Internet .....	44
Java™ .....	44
shortcuts .....	14
SIM card	
copying from .....	21
copying to .....	21
lock and unblock .....	58
sound recorder .....	42
speed dialing .....	23
standby .....	7
startup screen .....	6
stopwatch .....	56
submenus .....	13
synchronizing .....	50

## T

tasks .....	55
text .....	18
text message .....	27
themes .....	58
time .....	58
timer .....	56

transfer method	
Bluetooth technology .....	46
USB .....	49
transferring	
files .....	49
music .....	39
pictures .....	37
troubleshooting .....	60
turn on the phone .....	6
turning on/off	
phone lock .....	59
SIM lock protection .....	59
<b>U</b>	
unblock SIM card .....	58
update service .....	51

<b>V</b>	
vibrating alert .....	41
video player .....	43
voice messages .....	31
voicemail .....	23
volume	
ear speaker .....	19
ringtone .....	41
<b>W</b>	
warranty .....	69
<b>Z</b>	
zoom .....	36

## Free Manuals Download Website

<http://myh66.com>

<http://usermanuals.us>

<http://www.somanuals.com>

<http://www.4manuals.cc>

<http://www.manual-lib.com>

<http://www.404manual.com>

<http://www.luxmanual.com>

<http://aubethermostatmanual.com>

Golf course search by state

<http://golfingnear.com>

Email search by domain

<http://emailbydomain.com>

Auto manuals search

<http://auto.somanuals.com>

TV manuals search

<http://tv.somanuals.com>