



## Product Description

The Tannoy CVS6 is a full bandwidth ceiling speaker system. The design comprises a 150mm (6.00") mid bass driver with a coaxially mounted 19mm (0.75") high frequency section mounted in a vented, injection moulded, paintable front baffle manufactured from UV/weather resistant UL94V-0 ABS material.

The mineral loaded polypropylene cone material and nitrile rubber surround enhance durability and long-term reliability. This compact unit is specifically designed for applications requiring the combination of excellent sonic quality for music and speech reinforcement and exceptional reliability.

The CVS6 is equipped with a low insertion loss 60W line transformer easily configurable to the following settings via front baffle mounted rotary tapping switch:

**70V systems: 60W / 30W / 15W / 7.5W / OFF & low Impedance operation**  
**100V systems: 60W / 30W / 15W / OFF & low Impedance operation**

The CVS6 is supplied with an integral zinc-plated steel back can, with recessed termination box, to satisfy the vast majority of installation application requirements. The removable locking connector has screw terminals for secure wire termination and "loop through" facility. Strain relief is provided by a clamping mechanism for use with plenum rated cable or conduit. Security toggle clamps make for quick and easy installation, while two tile support rails and one C-ring are also included in the package. A plaster (mud) ring is available as an optional accessory.

## Features

- Coaxially mounted 150 mm (6.00") mineral loaded woofer with rubber surround and 19mm (0.75") soft dome diffraction loaded tweeter.
- High power & high sensitivity with extended frequency response and very low distortion
- Wide, controlled constant directivity dispersion for optimum coverage.
- UV/weather resistant UL94V-0 ABS front baffle
- Easily accessible tapping switch on front baffle.
- Low insertion loss 60W line transformer
- Ferrofluid cooled neodymium HF
- Packaged with tile rails and C-ring for quick & easy installation and simple stocking logistics

## Applications

- Multizone Foreground Music & Paging Systems
- Boardrooms & Offices
- Business Music Systems
- Airports, Convention Centres, Hotels
- Reception / Waiting Rooms
- Houses of Worship
- Retail Outlets / Shopping Malls
- Lounges / Bars
- Cruise Ships
- Courtrooms

Tannoy United Kingdom  
Tannoy North America  
Tannoy Deutschland  
Tannoy France

T: 00 44 (0) 1236 420199  
T: 00 1 (519) 745 1158  
T: 00 49 (180) 1111 881  
T: 00 33 (0)1 7036 7473

E: enquiries@tannoy.com  
E: inquiries@tannoyna.com  
E: anfragen@tannoy.com  
E: ventes@tannoy.com

tannoy®.com



## TECHNICAL SPECIFICATIONS

<b>System</b>	<b>CVS6</b>
<b>Frequency Response (-3dB) <sup>(1)</sup></b>	79Hz - 21kHz
<b>Frequency Range (-10dB) <sup>(1)</sup></b>	60Hz - 24kHz
<b>System Sensitivity (1W @1m) <sup>(2)</sup></b>	91dB (1W - 2.45V for 6Ω)
<b>Nominal Coverage Angle</b>	90 Degrees Conical
<b>Coverage Angle (1kHz to 6kHz)</b>	93 Degrees Conical
<b>Directivity Factor (Q)</b>	7.7 average 1kHz to 6kHz
<b>Directivity Index (DI)</b>	8.0 averaged 1kHz to 6Hz
<b>Rated Maximum SPL</b>	109dB (average) 115dB (peak)
<b>Power Handling</b>	
Average	60W
Programme	120W
Peak	240W
<b>Recommended Amplifier Power</b>	120@ 6Ω
<b>Nominal Impedance</b>	6Ω
Transformer Taps (via front rotary switch)	
70V	60W / 30W / 15W / 7.5W / OFF & Low Impedance operation
100V	60W / 30W / 15W / OFF & Low Impedance operation
<b>Distortion</b>	
<b>10% Full Power</b>	2nd Harmonic    3rd Harmonic
250Hz	0.439%            0.140%
1kHz	0.396%            0.458%
10kHz	0.235%            0.023%
<b>1% Full Power</b>	2nd Harmonic    3rd Harmonic
250Hz	1.16%              0.214%
1kHz	1.014%            0.685%
10kHz	0.944%            0.047%
<b>Crossover</b>	2.5kHz

### Notes

- (1) Average over stated bandwidth. Measured at 1 metre on axis.
- (2) Unweighted pink noise input, measured at 1 metre in an anechoic chamber

A full range of measurements, performance data, and Ease™ Data can be downloaded from [www.tannoy.com](http://www.tannoy.com)

Tannoy operates a policy of continuous research and development. The introduction of new materials or manufacturing methods will always equal or exceed the published specifications, which Tannoy reserves the right to alter without prior notice. Please verify the latest specifications when dealing with critical applications.

<b>Transducers</b>	
<b>Low Frequency</b>	150mm (6.00") mineral loaded cone
<b>High Frequency</b>	19mm (0.75) softdome
<b>Physical</b>	
<b>System Type</b>	Ceiling speaker with integral (Blind Mount) Back Can
<b>Enclosure</b>	
Backcan	Zinc plated steel
Baffle	Reflex loaded UL 94V-0 rated ABS
Grille	Steel, with weather resistant coating
<b>Safety Features</b>	Safety ring located at rear of enclosure for load bearing safety bond
<b>Clamping Design</b>	Security Toggle Clamp
<b>Backcan Options</b>	
Blind Mount (BM)	Yes
Pre Install (PI)	NA
<b>Cable Entry Options</b>	Cable clamp & squeeze connector for conduit up to 22mm
<b>Connectors</b>	Removable locking connector with screw terminals with "loop through" facility
<b>Safety Agency Rating (pending)</b>	U, CEL-1480, UI-2043
<b>BM Hole Cutout Diameter</b>	250mm (9.84")
<b>Dimensions</b>	
Bezel Diameter	279.5mm (11.01")
Front of ceiling to rear of backcan	246.5mm (9.70")
Front of Ceiling to top of safety loop	258.5mm (10.18")
<b>Included Accessories</b>	C Ring, tile bridge, paint mask, cutout template, grille
<b>Optional Accessories</b>	Plaster (Mud) Ring

### Ordering Information

PART NUMBER	MODEL NAME	COLOUR	PACKED QUANTITY	PACKED WEIGHT
8001 4240	CVS6	White / paintable	2	15.00 (33.07)
8001 4180	CVS6 Plaster (Mud) Rin	Zinc plated steel	10	6.00 (13.23)
8001 3830	CMVS6 PI back can	Zinc plated steel	1	3.10 (6.83)

Tannoy United Kingdom  
Tannoy North America  
Tannoy Deutschland  
Tannoy France

T: 00 44 (0) 1236 420199  
T: 00 1 (519) 745 1158  
T: 00 49 (180) 1111 881  
T: 00 33 (0)1 7036 7473

E: [enquiries@tannoy.com](mailto:enquiries@tannoy.com)  
E: [inquiries@tannoyna.com](mailto:inquiries@tannoyna.com)  
E: [anfragen@tannoy.com](mailto:anfragen@tannoy.com)  
E: [ventes@tannoy.com](mailto:ventes@tannoy.com)

[tannoy.com](http://tannoy.com)



## PERFORMANCE MEASUREMENTS

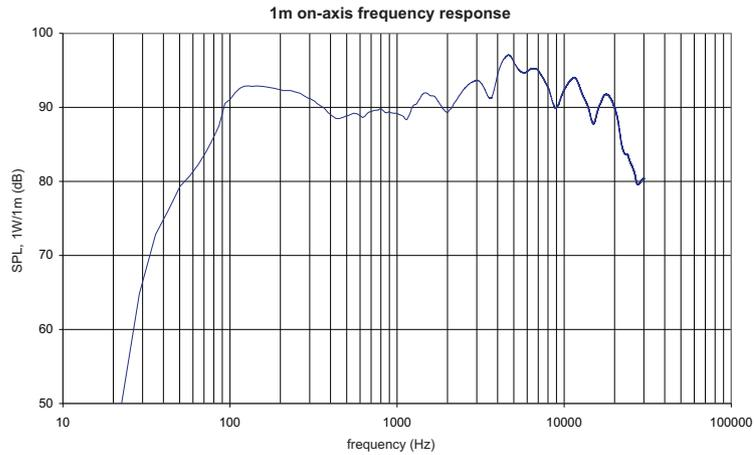

**ANECHOIC  
FREQUENCY  
RESPONSE**

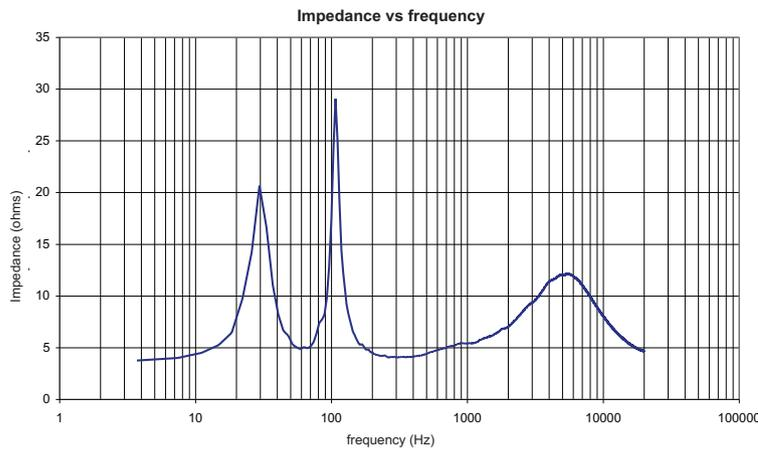

**IMPEDANCE**

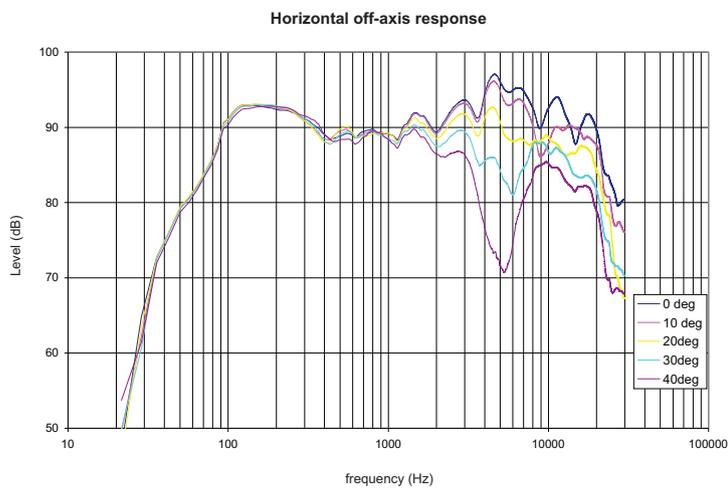

**OFF AXIS  
RESPONSE**

Tannoy United Kingdom  
 Tannoy North America  
 Tannoy Deutschland  
 Tannoy France

T: 00 44 (0) 1236 420199  
 T: 00 1 (519) 745 1158  
 T: 00 49 (180) 1111 881  
 T: 00 33 (0)1 7036 7473

E: enquiries@tannoy.com  
 E: inquiries@tannoyna.com  
 E: anfragen@tannoy.com  
 E: ventes@tannoy.com

**tannoy®.com**



## PERFORMANCE MEASUREMENTS

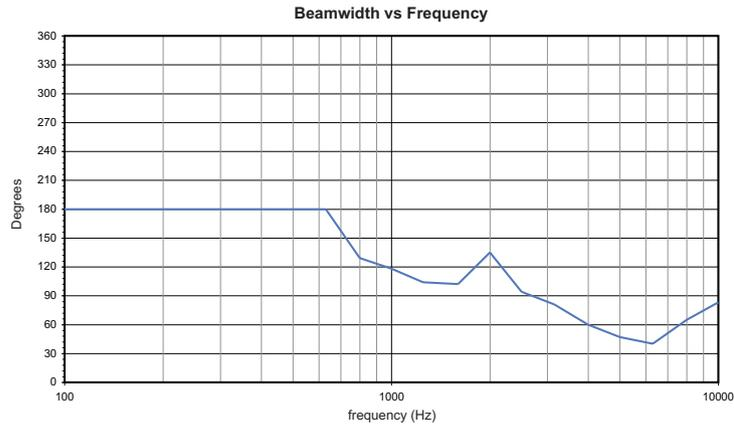

BEAMWIDTH

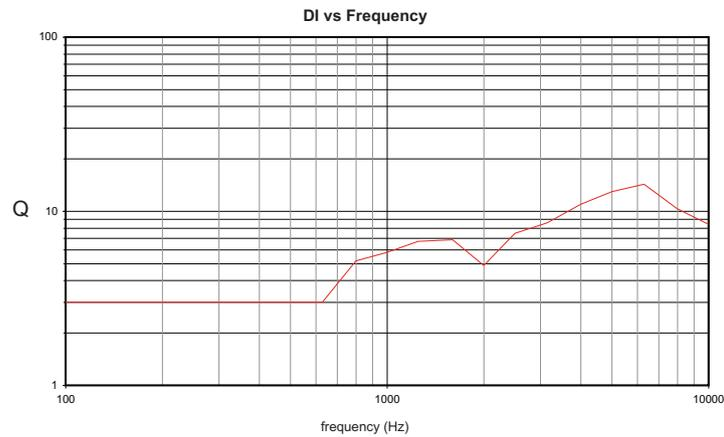

DIRECTIVITY INDEX

Tannoy United Kingdom  
Tannoy North America  
Tannoy Deutschland  
Tannoy France

T: 00 44 (0) 1236 420199  
T: 00 1 (519) 745 1158  
T: 00 49 (180) 1111 881  
T: 00 33 (0)1 7036 7473

E: enquiries@tannoy.com  
E: inquiries@tannoyna.com  
E: anfragen@tannoy.com  
E: ventes@tannoy.com

tannoy®.com



# CVS 6

# TANNOY®

## PERFORMANCE MEASUREMENTS POLAR PLOTS (1/3 OCTAVE)

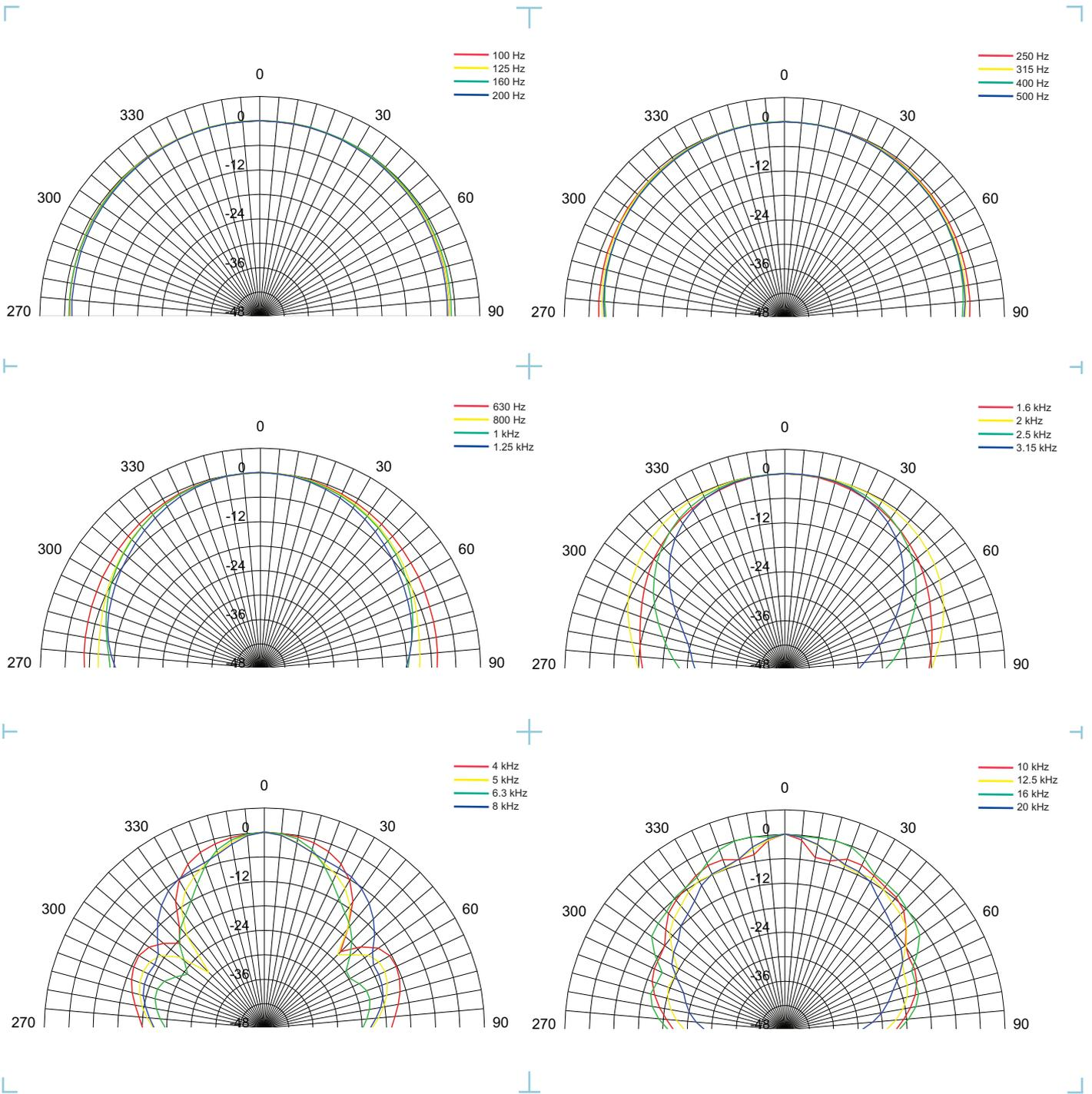

Tannoy United Kingdom  
 Tannoy North America  
 Tannoy Deutschland  
 Tannoy France

T: 00 44 (0) 1236 420199  
 T: 00 1 (519) 745 1158  
 T: 00 49 (180) 1111 881  
 T: 00 33 (0)1 7036 7473

E: enquiries@tannoy.com  
 E: inquiries@tannoyna.com  
 E: anfragen@tannoy.com  
 E: ventes@tannoy.com

tannoy.com



# CVS 6

TANNOY®

## DIMENSIONAL SKETCHES

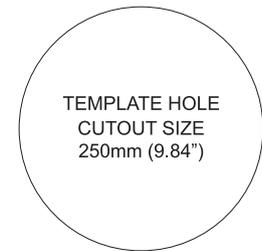
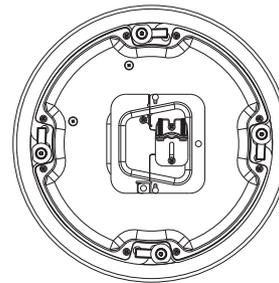
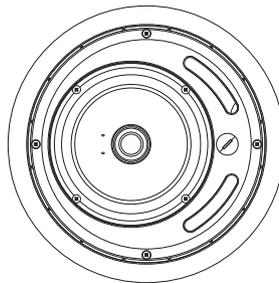
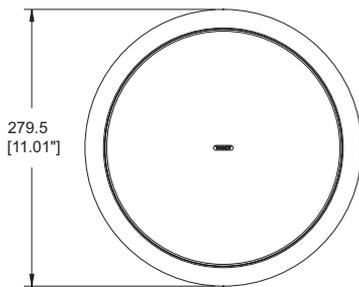
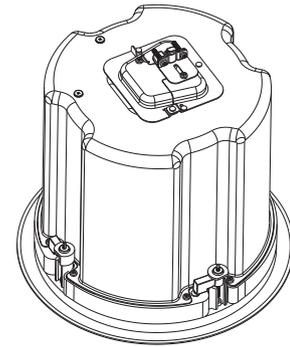
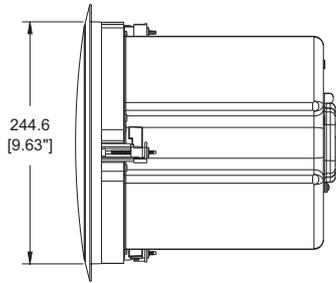
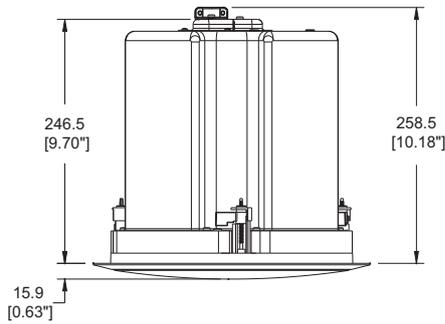

CVS4

TEMPLATE HOLE CUTOUT SIZE - 250mm (9.84")

### SUPPLIED ACCESSORIES

C-RING

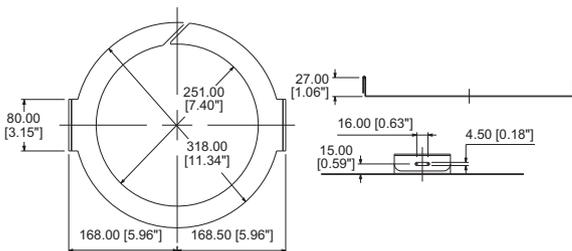

### OPTIONAL ACCESSORIES

PLASTER (MUD) RING

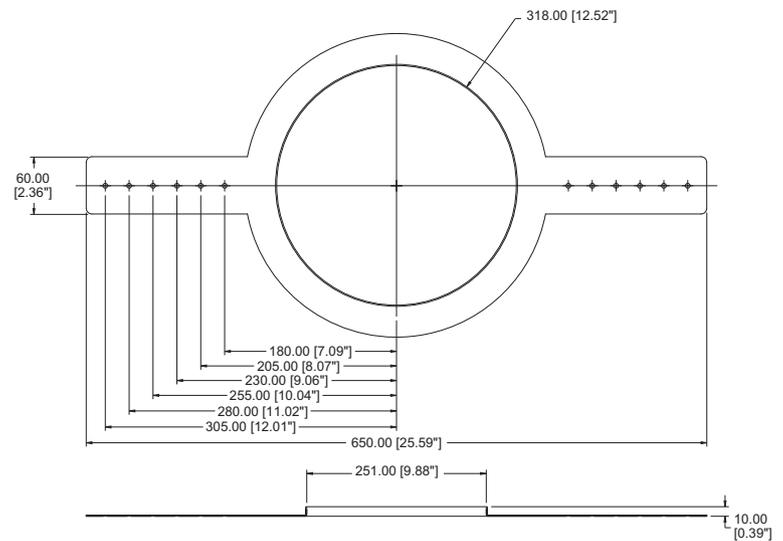

### Ordering Information

PART NUMBER	MODEL NAME	COLOUR	PACKED QUANTITY	PACKED WEIGHT
8001 4240	CVS6	White / paintable	2	15.00 (33.07)
8001 4180	CVS6 Plaster (Mud) Rin	Zinc plated steel	10	6.00 (13.23)
8001 3830	CMVS6 PI back can	Zinc plated steel	1	3.10 (6.83)

Tannoy United Kingdom  
Tannoy North America  
Tannoy Deutschland  
Tannoy France

T: 00 44 (0) 1236 420199  
T: 00 1 (519) 745 1158  
T: 00 49 (180) 1111 881  
T: 00 33 (0)1 7036 7473

E: enquiries@tannoy.com  
E: inquiries@tannoyna.com  
E: anfragen@tannoy.com  
E: ventes@tannoy.com

tannoy.com



## Architectural specifications

The Ceiling Speaker System shall consist of a 150mm (6.00") mineral loaded mid bass driver with coaxially mounted 19mm (0.75") high frequency unit and passive frequency dividing network mounted in a vented, injection moulded, paintable front baffle in UL94V-0 ABS material.

The backcan shall be constructed of zinc plated steel. A recessed termination box shall be integrated with the backcan, a removable locking connector with screw terminals for secure wire termination with "loop through" facility shall be provided. Strain relief will be provided by a clamping mechanism for use with plenum rated cable or conduit. A safety ring is located on the rear of the backcan for a load bearing safety bond.

Performance of the ceiling speaker shall meet or exceed the following criteria: The system shall have a conical coverage pattern of 93 degrees (1kHz to 6kHz). Frequency response measured on axis shall be 60Hz -24kHz (-10dB from rated sensitivity, measured in an IEC baffle in an anechoic chamber) with no equalization. Sensitivity shall be 91dB (1W @ 1m). Long term power handling capacity as defined in EIA-426B test shall be 60W, recommended amplifier power 120W. The nominal system impedance shall be 6W (in low impedance setting).

The ceiling speaker system shall be equipped with a 60W high performance line transformer for use in 70.7 or 100 Volt distributed audio systems with 60, 30, 15, 7.5\* Watt taps available. An easily accessible rotary switch located on the front baffle shall be available for selecting transformer and low impedance settings. A weather resistant perforated steel grille covers the transducer and switch.

Two support rails and one C-Ring shall be included with the ceiling monitor system. The front face diameter shall not exceed 279.5mm (11.01"), overall depth from the front of the ceiling to the top of the safety loop shall not exceed 258.5mm (10.18"). The template cut out diameter shall be 250mm (9.84")

**The Ceiling Monitor System shall be the.....CVS6**

\*70 Volt only

Tannoy United Kingdom  
Tannoy North America  
Tannoy Deutschland  
Tannoy France

T: 00 44 (0) 1236 420199  
T: 00 1 (519) 745 1158  
T: 00 49 (180) 1111 881  
T: 00 33 (0)1 7036 7473

E: enquiries@tannoy.com  
E: inquiries@tannoyna.com  
E: anfragen@tannoy.com  
E: ventes@tannoy.com

tannoy®.com



## Free Manuals Download Website

<http://myh66.com>

<http://usermanuals.us>

<http://www.somanuals.com>

<http://www.4manuals.cc>

<http://www.manual-lib.com>

<http://www.404manual.com>

<http://www.luxmanual.com>

<http://aubethermostatmanual.com>

Golf course search by state

<http://golfingnear.com>

Email search by domain

<http://emailbydomain.com>

Auto manuals search

<http://auto.somanuals.com>

TV manuals search

<http://tv.somanuals.com>