



owner's manual

MIX.22OFX
MIX.26OFX

COMPACT MIXERS

**MIX-FX
SERIES**



TOTAL AUDIO PRODUCTION

CAUTION AVIS



RISK OF ELECTRIC SHOCK
DO NOT OPEN
RISQUE DE CHOC ELECTRIQUE
NE PAS OUVRIR



**CAUTION: TO REDUCE THE RISK OF ELECTRIC SHOCK
DO NOT REMOVE COVER (OR BACK)
NO USER-SERVICEABLE PARTS INSIDE
REFER SERVICING TO QUALIFIED PERSONNEL**

ATTENTION: POUR EVITER LES RISQUES DE CHOC
ELECTRIQUE, NE PAS ENLEVER LE COUVERCLE. AUCUN
ENTRETIEN DE PIECES INTERIEURES PAR L'USAGER. CONFIER
L'ENTRETIEN AU PERSONNEL QUALIFIE.
AVIS: POUR EVITER LES RISQUES D'INCENDIE OU
D'ELECTROCUTION, N'EXPOSEZ PAS CET ARTICLE
A LA PLUIE OU A L'HUMIDITE



The lightning flash with arrowhead symbol within an equilateral triangle is intended to alert the user to the presence of uninsulated "dangerous voltage" within the product's enclosure that may be of sufficient magnitude to constitute a risk of electric shock to persons.
Le symbole éclair avec point de flèche à l'intérieur d'un triangle équilatéral est utilisé pour alerter l'utilisateur de la présence à l'intérieur du coffret de "voltage dangereux" non isolé d'ampleur suffisante pour constituer un risque d'électrocution.



The exclamation point within an equilateral triangle is intended to alert the user of the presence of important operating and maintenance (servicing) instructions in the literature accompanying the appliance.
Le point d'exclamation à l'intérieur d'un triangle équilatéral est employé pour alerter les utilisateurs de la présence d'instructions importantes pour le fonctionnement et l'entretien (service) dans le livret d'instruction accompagnant l'appareil.

SAFETY INSTRUCTIONS

1. Read these instructions.
2. Keep these instructions.
3. Heed all warnings.
4. Follow all instructions.
5. Do not use this apparatus near water.
6. Clean only with a dry cloth.
7. Do not block any ventilation openings. Install in accordance with the manufacturer's instructions.
8. Do not install near any heat sources such as radiators, heat registers, stoves, or other apparatus (including amplifiers) that produce heat.
9. Do not defeat the safety purpose of the polarized or grounding-type plug. A polarized plug has two blades with one wider than the other. A grounding-type plug has two blades and a third grounding prong. The wide blade or the third prong are provided for your safety. If the provided plug does not fit into your outlet, consult an electrician for replacement of the obsolete outlet.
10. Protect the power cord from being walked on or pinched particularly at plugs, convenience receptacles, and the point where they exit from the apparatus.
11. Only use attachments/accessories specified by the manufacturer.
12. Use only with a cart, stand, tripod, bracket, or table specified by the manufacturer, or sold with the apparatus. When a cart is used, use caution when moving the cart/apparatus combination to avoid injury from tip-over.

PORTABLE CART WARNING



Carts and stands - The Component should be used only with a cart or stand that is recommended by the manufacturer.
A Component and cart combination should be moved with care. Quick stops, excessive force, and uneven surfaces may cause the Component and cart combination to overturn.

13. Unplug this apparatus during lightning storms or when unused for long periods of time.
14. Refer all servicing to qualified service personnel. Servicing is required when the apparatus has been damaged in any way, such as when the power-supply cord or plug has been damaged, liquid has been spilled or objects have fallen into the apparatus, the apparatus has been exposed to rain or moisture, does not operate normally, or has been dropped.
15. This apparatus shall not be exposed to dripping or splashing, and no object filled with liquids, such as vases, shall be placed on the apparatus.
16. This apparatus has been designed with Class-I construction and must be connected to a mains socket outlet with a protective earthing connection (the third grounding prong).
17. This apparatus has been equipped with a single-pole rocker-style AC mains power switch. This switch is located on the front panel and should remain readily accessible to the user.
18. This apparatus does not exceed the Class A/Class B (whichever is applicable) limits for radio noise emissions from digital apparatus as set out in the radio interference regulations of the Canadian Department of Communications.

ATTENTION –Le présent appareil numérique n'émet pas de bruits radioélectriques dépassant les limites applicables aux appareils numériques de class A/de class B (selon le cas) prescrites dans le règlement sur le brouillage radioélectrique édicté par les ministères des communications du Canada.

19. Exposure to extremely high noise levels may cause permanent hearing loss. Individuals vary considerably in susceptibility to noise-induced hearing loss, but nearly everyone will lose some hearing if exposed to sufficiently intense noise for a period of time. The U.S. Government's Occupational Safety and Health Administration (OSHA) has specified the permissible noise level exposures shown in the following chart.

According to OSHA, any exposure in excess of these permissible limits could result in some hearing loss. To ensure against potentially dangerous exposure to high sound pressure levels, it is recommended that all persons exposed to equipment capable of producing high sound pressure levels use hearing protectors while the equipment is in operation. Ear plugs or protectors in the ear canals or over the ears must be worn when operating the equipment in order to prevent permanent hearing loss if exposure is in excess of the limits set forth here.

Duration Per Day In Hours	Sound Level dBA, Slow Response	Typical Example
8	90	Packed garage concert
6	92	
4	95	VW Bus Peace Train
3	97	
2	100	Cranked psychedelic tunes
1.5	102	
1	105	High speed chase on C.H.I.P.s
0.5	110	
0.25 or less	115	Loudest parts at a Heavy Metal

WARNING – To reduce the risk of fire or electric shock, do not expose this appliance to rain or moisture.

CONTENTS

SAFETY INSTRUCTIONS.....	2
Getting Started.....	4
Introduction.....	6
Hookup Diagrams.....	7
MIX FX Series Features	8
CHANNEL INPUTS.....	8
CHANNEL CONTROLS.....	9
AUXILIARY.....	9
CONTROL ROOM SECTION.....	11
AUXILIARY SECTION.....	13
INTERNAL EFFECTS.....	14
MAIN MIX, SUBS, and POWER LEDs.....	14
FRONT PANEL CONNECTORS.....	15
REAR PANEL FEATURES.....	16
Appendix A: Service Information.....	18
Appendix B: Connections	20
Appendix C: MIX FX Series Specifications	21
Block Diagram Mix.220FX	23
Block Diagram Mix.260FX	24
TAPCO LIMITED WARRANTY	27

**Don't forget to visit our website at www.tapcogear.com
for more information about this and other TAPCO products.**

What me, read a manual?

Before you begin, please make sure you read the Safety Instructions on page 2 and Getting Started on page 4.

Your new TAPCO® MIX FX Series mixer is designed to set up quickly and operate easily. We know it's often seen as a sign of weakness to read a manual, along with asking for directions when lost, but maybe you can read the rest when nobody is looking.

It is important to keep your receipt in a safe place, and not a bad idea to write your product information here for future reference (i.e., insurance claims, tech support, return authorization, etc.).

Product Serial #:

Purchased at:

Date of purchase:



GETTING STARTED

The following steps will help you set up your mixer, and get the levels and adjustments just right.

ZERO THE CONTROLS:

1. Leave the POWER cord disconnected from the MIX FX Series mixer.
2. Turn down the channel strip GAIN, AUX SEND, and fader controls.
3. Center the channel strip EQ and PAN/BAL controls.
4. Turn down the MASTER AUX SENDS, AUX RETURN, FX RETURN and CTRL ROOM/ PHONES controls.
5. Leave all switches out (up).
6. Turn down the ALT 3/4 or SUB 1/2 faders, and the MAIN MIX faders.

CONNECTIONS:

1. Connect your speakers to your amplifier's outputs (unless, of course, you have powered speakers).
2. Using TR or TRS cables, make connections from your mixer's MAIN OUTS to your amplification system's line inputs.
3. Connect your microphones and instruments to the mixer: Connect microphones to the mono channel MIC INPUT jacks. (For condenser microphones, turn on the PHANTOM POWER switch.) Connect line-level signal sources to the LINE input jacks.

Note: Normally, you would plug in only one microphone or one instrument into each mono channel.

4. Zero the controls, as described above.
5. Connect the power cord supplied with your mixer to the AC socket on the back and plug it into an AC outlet properly configured for your model.
6. Plug all other sound system components into suitable AC outlets, properly grounded and capable of delivering adequate current.
7. Turn all the power switches on, leaving the speaker's amplifier's switch for last.
8. Turn up the MAIN MIX fader to the -10 mark, for now. We'll crank it up later on.
9. Now you are ready to set the levels.

SET THE LEVELS (Mic/Line Channels):

1. Choose one of the microphones or instruments you connected to the mono MIC or LINE input. Make some noise. If it's a microphone, sing at your normal singing volume. If it's an instrument, play it at its normal output level.
2. Push in the channel's SOLO switch next to the fader (make sure the SOLO MODE switch above the meters is up, in PFL mode). While making noise, turn up that channel's GAIN control until the +7 and +10 indicators on the meters are flashing. If the CLIP LEDs start blinking, turn down the GAIN control a bit.
3. Raise that channel's fader to unity gain (**U** label). You should be hearing your noise now.
4. If necessary, apply channel EQ changes. (You may need to compensate for level changes afterward with the channel fader control.)
5. Repeat steps 1 through 4 for the other Mic/Line channel(s).
6. Stop making noise. Everyone: start making music.
7. Now turn up the MAIN MIX control to a comfortable listening level.

SET THE LEVELS (Stereo Line Channels):

1. Make some noise with the mono or stereo instrument connected to the LINE IN jacks on a stereo line-input channel.
2. Push in the channel's SOLO switch next to the fader. Adjust the line-input signal level at the source until the +7 and +10 indicators on the meters are flashing. If the CLIP LEDs start blinking, turn down the signal level a bit.
3. Raise that channel's fader to unity gain (**U** label). You should be hearing your noise now.
4. If necessary, apply channel EQ changes. (You may need to compensate for level changes afterward with the channel LEVEL control.)
5. Repeat steps 1 through 4 for the remaining stereo channels.

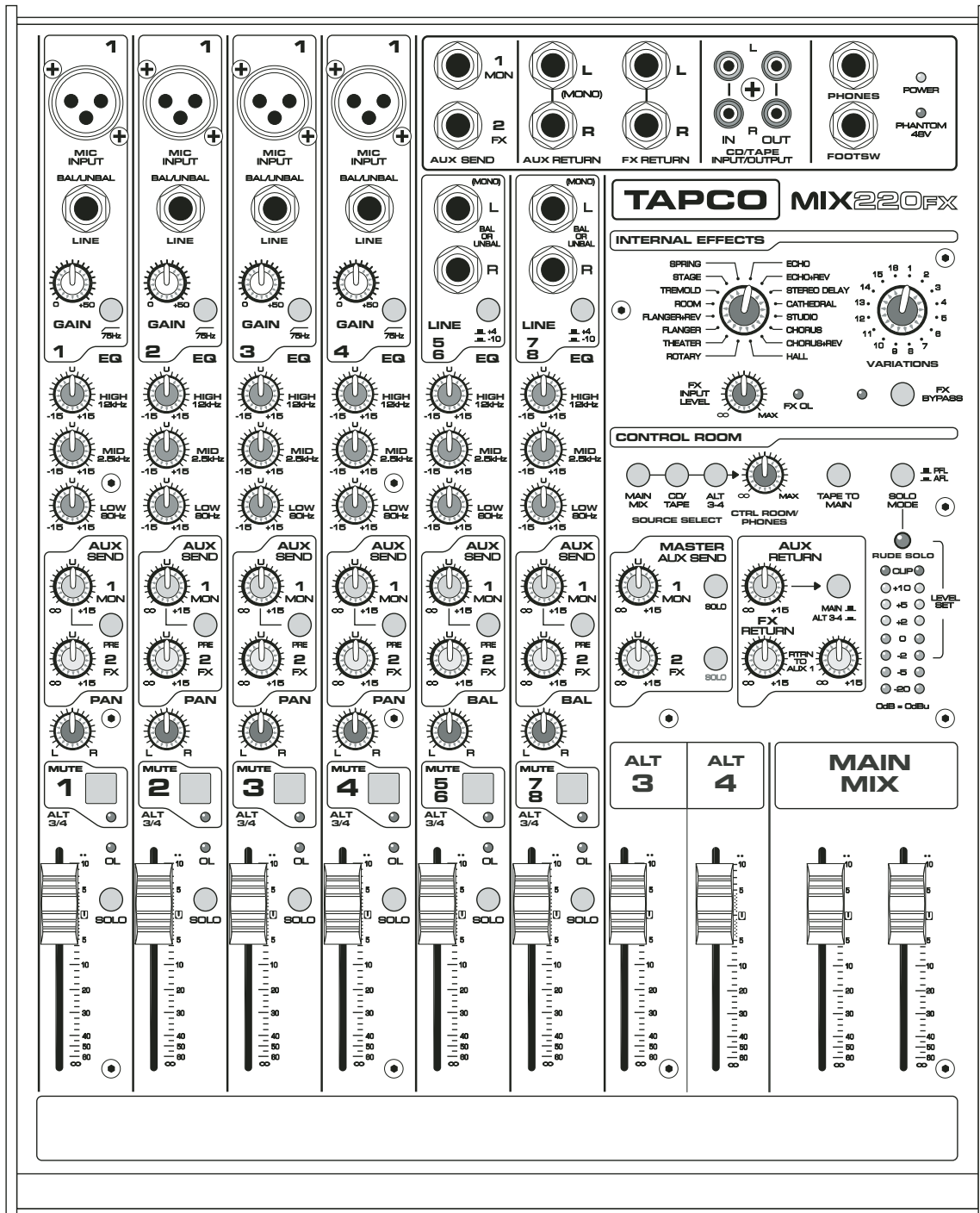

A FEW PRECAUTIONS:

- Never listen to loud music for prolonged periods. Please see the Safety Instructions on page 2 for information on hearing protection.
- Never plug amplifier speaker-level outputs into anything except speakers.
- Never use guitar cables to connect amplifiers to speakers.
- Before making connections to an external amplifier, or reconfiguring an amp's routing, turn the amp's level (gain) controls down, turn the power off, make the changes, turn the power back on, and then turn the level controls back up.
- When you shut down your equipment, turn off any external amplifiers first. When powering up, turn on the amplifiers last.
- Save the shipping box and packing material! The box can also be turned into a unique hat, lunch box, or handbag to accessorize your mixer.

INTRODUCTION

Thank you for choosing a TAPCO MIX FX Series mixer. The TAPCO family of mixers hails back to the days of TAPCO Corporation, Greg Mackie's first company. TAPCO revolutionized the audio industry back in 1969 with the very first 6-channel mixer specifically designed for keyboards and rock 'N' roll PA.

The first TAPCO mixer, although primitive by today's standards, was truly innovative for its time. It had the headroom to handle screaming singers, was priced for the pocketbook of starving psychedelic musical neophytes, and durable enough to withstand mammoth levels of wear and tear on the road, and at now-legendary concerts.

In essence, TAPCO re-defined the price/performance ratio and made high-quality professional audio mixers accessible to virtually anyone. Today, TAPCO is reborn with the same ideals and is backed by the world-class engineering and manufacturing horsepower of LOUD Technologies.

These compact mixers are perfect for small to medium-sized live sound reinforcement applications, keyboards and synths, video, and small-project studio applications.

HERE'S A QUICK GLANCE AT ALL THE FEATURES PACKED INTO THESE MIXERS:

Mono mic/line channels:

- XLR microphone input jack
- 1/4" TRS line-input jack
- Phantom power, globally switched
- Variable input trim (0 to +50 dB)
- Overload (OL) indicator LED
- Monitor Aux Send with Pre/Post switch
- Post-fader FX Aux Send
- 3-band EQ
- 75 Hz low-cut filter
- Pan control
- Mute switch (Mute/Alt 3-4 switch on 220FX)
- Solo switch
- Sub 1-2 and L-R assign switches (260 FX only)
- 60 mm fader

Stereo line channels:

- Left and right 1/4" TRS line input jacks
- +4/-10 input level switch
- Monitor Aux Send with Pre/Post switch
- Post-fader FX Aux Send
- 3-band EQ
- Balance control
- Mute switch (Mute/Alt 3-4 switch on 220FX)
- Solo switch
- Sub 1-2 and L-R assign switches (260 FX only)
- 60 mm fader

Master section:

- 60mm fader Main Mix controls
- 60mm fader Alt 3-4 controls (220FX only)
- 60mm fader Sub 1-2 controls (260FX only) with Assign to Main Mix switches

- Balanced 1/4" TRS stereo main outputs
- 12-segment stereo LED VU metering
- 1/4" TRS Aux Sends with rotary level controls
- Stereo RCA tape out and tape in
- Stereo 1/4" Phones output
- Internal digital effects section with effects select control, variations control, input level control, FX overload LED, and FX bypass switch
- 1/4" Footswitch jack to bypass the internal effects, duplicates the FX bypass switch
- Source select switches for Control Room/Phones output
- Rotary Ctrl Room/Phones level control
- Tape to Main switch
- Solo mode switch (PFL/AFL)
- Aux Return 1 level control with Main/Sub 1-2 assign switch
- Aux Return 2 (FX) level control with Return to Aux 1 level control
- Inter-Planetary Space Drive control
- OK, we made that last one up, but we can pencil it in for next time

Rear panel:

- Main power switch
- Master +48V phantom power switch with LED indicator (except Mix.50)
- Left and Right XLR Main Outs
- Left and Right 1/4" Alt 3/4 Outs (220FX) or Sub 1-2 Outs (260FX)
- Left and Right 1/4" TRS Control Room outputs
- 1/4" Insert jacks for channels 1-4 (260FX only)

HOOKUP DIAGRAMS

Small Club Gig

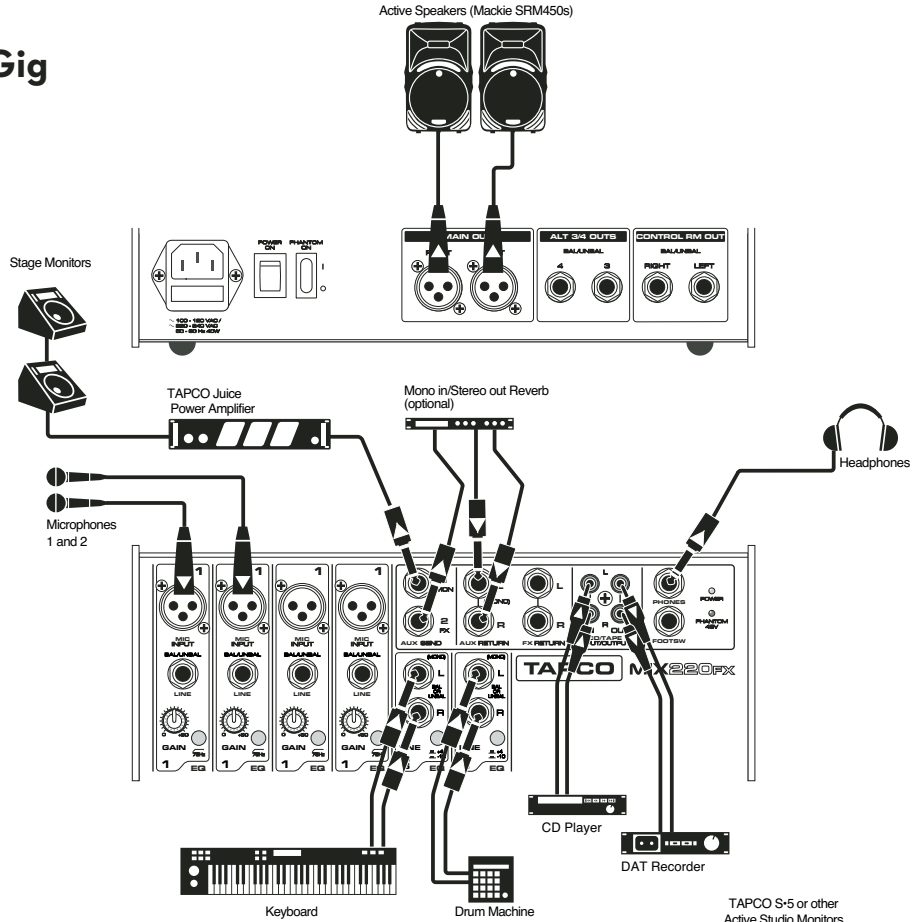

Computer set-up

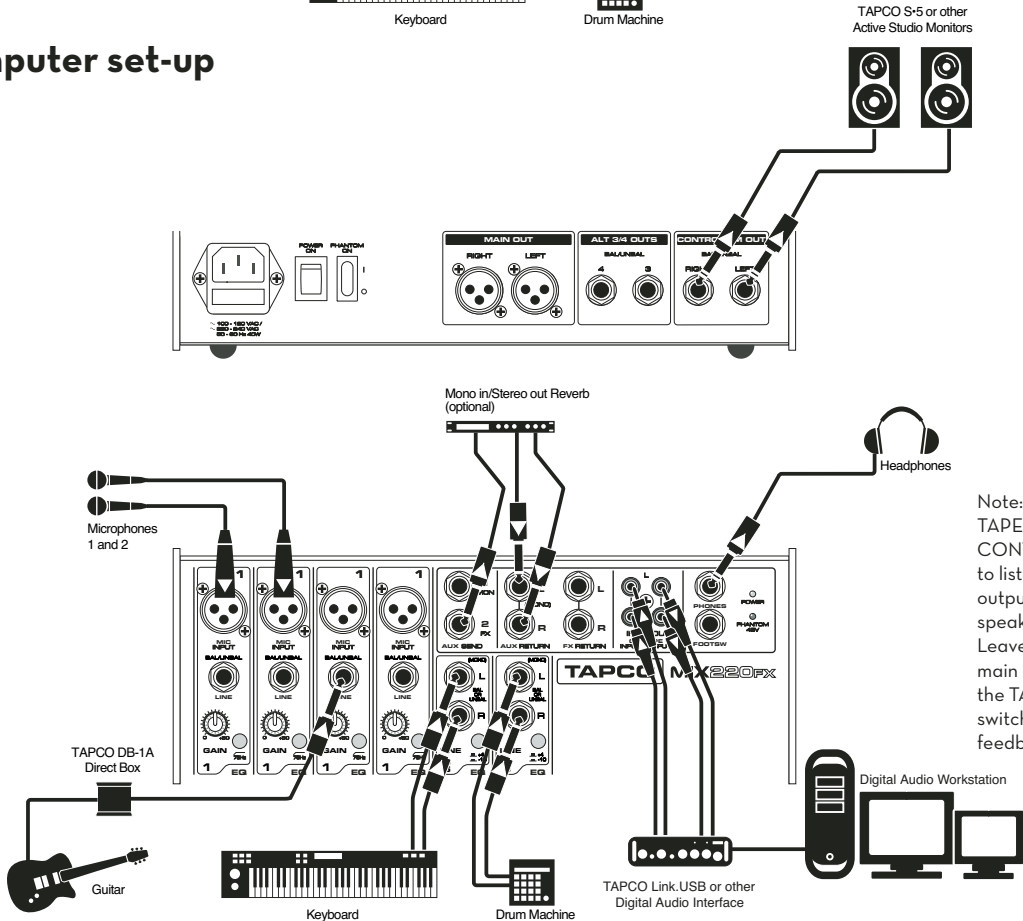

Note: Push down the CD/TAPE [21] switch in the CONTROL ROOM section to listen to the DAW output in the control room speakers and headphones. Leave it up to listen to the main mix. Do not press the TAPE TO MAIN [24] switch, or there will be feedback.

MIX FX SERIES FEATURES

CHANNEL INPUTS

1. MIC (MICROPHONE) INPUTS

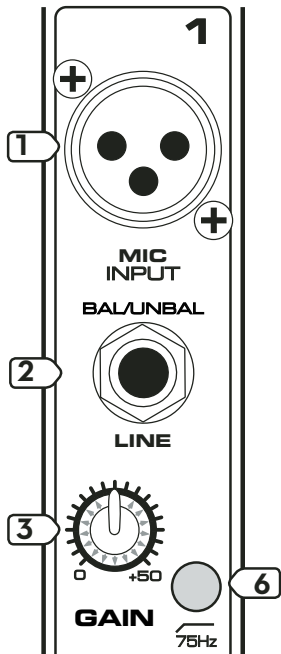

Mix.220FX Mono Channel

The MIX FX Series is equipped with four rugged, low-noise, phantom-powered microphone preamplifiers, providing up to 50 dB of crystal-clear amplification. Their balanced circuitry rejects all manner of extraneous interference. Professional condenser, dynamic, and ribbon mics all sound excellent through these XLR inputs.

You can plug in almost any kind of balanced mic that has a standard XLR-type male mic connector. See Appendix B for more information on XLR connectors.

The MIX FX Series provides +48 VDC phantom powering on pins 2 and 3 of the mono channels' XLR MIC inputs. This can be turned on and off using the PHANTOM [58] switch.



CAUTION: DO NOT connect a line-level device to a MIC input with the phantom power switched on. This could damage the device. Use the LINE IN [2] jacks instead.

Do not use phantom power with tube or ribbon microphones, as this may cause damage.

2. LINE INPUTS

These inputs can accept 1/4" TRS balanced and TS unbalanced plugs from any line-level instrument, effects device, or tape player. They can be driven by virtually any line-level signal, from -45 dBu up to +18 dBu.

There are two line-inputs for each stereo channel, a left and a right. When connecting a stereo device (two cords), use both the left (mono) input and the right input.

When connecting a mono device (just one cord), always use the left (mono) input and plug nothing into the right input. A trick called "jack normaling" causes the signal to appear on both sides.

3. GAIN CONTROL (Mono Channels only)

If you haven't already, please read "SET THE LEVELS" on page 4.

The GAIN control adjusts the input sensitivity of the MIC and LINE inputs. This allows signals from the outside world to be adjusted to optimal internal operating levels.

The GAIN control provides 50 dB of gain with the knob fully up.

4. +4/-10 Switch (Stereo channels only)

Instead of a rotary gain control, the stereo channels have a gain switch. This changes the input sensitivity of the channel to match either the -10 dBv consumer level or the +4 dBu professional level. Most consumer equipment with RCA connectors operate at the -10 dBv level, while most professional equipment with 1/4-inch phone jacks or XLR connectors operate at the +4 dBu level.

As you might expect, the +4 dBu level is higher (louder) than the -10 dBv level. If you have trouble getting enough volume from a signal connected to one of these stereo channels, push in the +4/-10 switch to get more volume.

5. OL LED

This handy LED (Light Emitting Diode) lets you know that the signals going into the mixer are adjusted to the correct level, not too strong to cause distortion and not too weak to be lost in noise.

After you connect a microphone or line-level component to the mixer, do a sound test and adjust the GAIN control until this handy LED flickers just occasionally. If it is glowing constantly, turn the GAIN down. If the LED is doing almost nothing, turn it up.

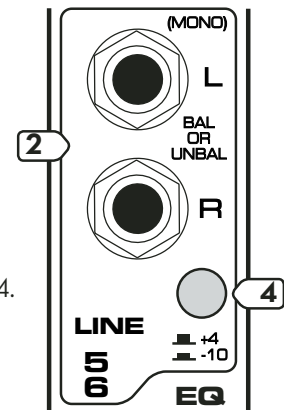

Mix.220FX Stereo Channel

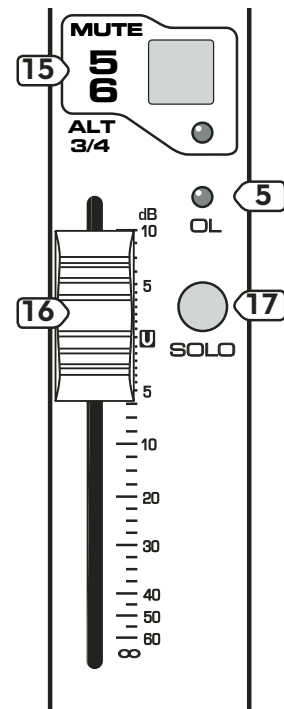

Mix.220FX Stereo Channel

CHANNEL CONTROLS

The channel strips have various controls, depending on the model and whether it is a mic/line (mono) channel or a stereo channel.

The output from each channel strip passes on to the left and right main mix. Two auxiliary signals can be tapped off and sent to monitors or effects processors. The block diagrams on pages 23-24 show how the signal flows through each mixer.



UNITY GAIN

The **U** symbol on most of the controls, stands for “unity gain,” meaning there is no change in signal level. Once you have adjusted the input signal to line-

level, you can set every control at **U**, and your signals will travel through the mixer at optimal levels.

EQUALIZATION

Each EQ control provides up to 15 dB of boost and cut, with no change to the signal (0 dB) in the center position. The Mix.220FX has three-band EQ on all the channels, while the Mix.260FX has three-band EQ with variable mid on the mono channels, and four-band EQ on the stereo channels.

Although you can bring a sound to life with proper EQ, you can also mess things up. If you max the EQs on every channel, you'll get mix mush, not to mention driving your mix levels near or beyond clipping. So equalize subtly; use cut as well as boost.

6. 75Hz Low-Cut Switch (Mono Channels only)

This switch cuts the bass frequencies below 75 Hz. We recommend that you use the Low-Cut switch on every microphone application except kick drum, bass guitar, bassy synth patches, or recordings of earthquakes. These aside, there isn't much down there that you want to hear, and filtering it out makes the low stuff you do want much more crisp and tasty.

7. HI EQ

Turning this clockwise boosts the level of all frequencies above 12 kHz. Turning it counter-clockwise cuts the levels.

Use this wisely to add sizzle to cymbals or an overall sense of transparency or edge to keyboards, vocals, guitar, and bacon frying. Turn it down a little to reduce sibilance or hide tape hiss.

8. MID EQ

Turning this clockwise boosts the level of frequencies at and around 2.5 kHz on the 220FX. Turning it counter-clockwise cuts the levels.

The 260FX has a sweepable MID EQ on the mono channels (see 9 next), and two discrete MID EQ controls on the stereo channels, with center frequencies at 3 kHz and 500 Hz [8a].

The midrange frequencies include the upper male and lower female vocal ranges, and the fundamentals and harmonics for many instruments.

9. MID FREQ (Mix.260FX Mono Channels only)

This allows you to change the center frequency for the MID EQ filter so you can zero in more accurately on the precise narrow band of frequencies you want to boost or cut. It ranges from 100 Hz to 8 kHz.

10. LOW EQ

Turning this clockwise boosts the level of all frequencies below 80 Hz. Turning it counter-clockwise cuts the levels.

Frequencies of 80 Hz and below represent the punch in bass drums, bass guitar, fat synth patches, and high-testosterone male singers.

AUXILIARY

In addition to the main mix output, the mixer provides two auxiliary mixes, which you can send to parallel effects processors and stage monitors.

The AUX SEND knobs adjust how much of each channel is tapped off, added to the aux mix, and sent out via the AUX SEND [45] jacks.

On the stereo channels, the AUX knob controls a mono sum of the channel's stereo signals. For instance, channel 5 (L) and 6 (R) mix together to feed that channel's AUX send knobs.

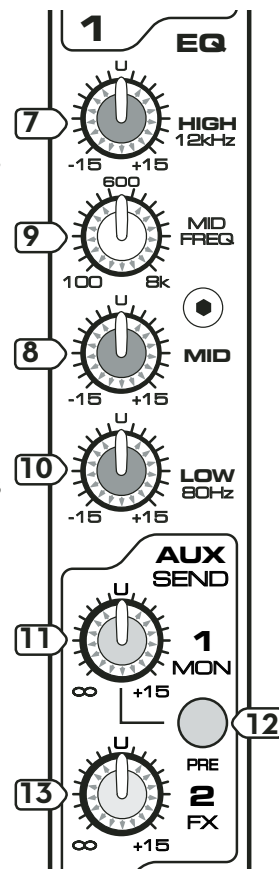

Mix.260FX Mono Channel

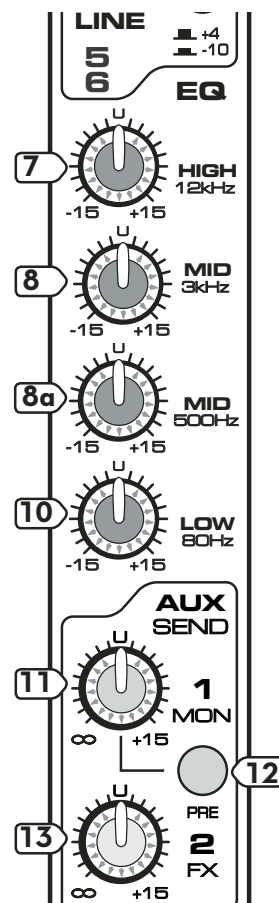

Mix.260FX Stereo Channel

11. AUX SEND 1 (MON)

The AUX SEND 1 can be used either as a monitor send (pre-fader) or an effects send (post-fader).

Push in the PRE [12] switch to use AUX SEND 1 as a monitor send and feed the mono input of a stage monitor amplifier via the AUX SEND 1 [45] output jack.

In pre-fader mode, the signal is tapped off **after** the EQ controls, but **before** the fader control, so the monitor send is not affected by changes in the Main Mix.

If you want to use the AUX SEND 1 as an effects send, leave the PRE switch up and use it as described for the AUX SEND 2 [13].

12. PRE

This switch determines whether the AUX SEND 1 is pre-fader (pushed in) or post-fader (out). Typically, push this switch in when using AUX SEND 1 as a monitor send, and leave it out when using it as an effects send.

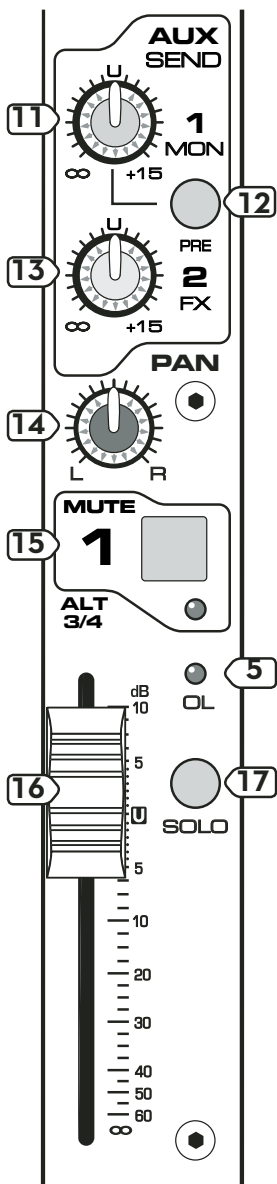

Mix.220FX Mono Channel

13. AUX SEND 2 (FX)

The AUX SEND 2 is used to feed the mono input of parallel effects devices via the AUX SEND 2 [45] output jack. All the channel controls (except PAN or BAL) will affect the AUX signal. The signal is tapped off **after** the fader control. The output from an external processor can come back in via the stereo FX RETURN [47] inputs, and can be added to either the main mix or the ALT 3-4 (on the 220FX) or the SUB 1-2 (on the 260FX).

14. PAN/BAL

This adjusts how much of the channel signal plays in the left side of the main mix, and how much plays in the right.

For mono mic/line channels, if PAN is in the center position, the mono signal appears equally in both the left and right of the main mix. If the control is set left, more of the signal appears in the left side. If the control is set right, more of the signal appears in the right side of the mix.

For stereo channels, the BAL control works like a home stereo balance control, by attenuating one side or the other. In the center position, the left and right channel signals pass through to the main mix unaffected. If it is turned left, the right channel is attenuated; if turned right, the left side is attenuated.

15. MUTE/ALT 3-4

The Mix.260FX has a simple MUTE switch. Engaging a channel's MUTE switch provides (almost) the same results as turning the fader all the way down (a pre-aux send is not affected by the channel fader, but it is by the MUTE switch). Any channel assignments to L-R MAIN MIX and SUB 1-2 will be interrupted, all the AUX sends will be silenced (both pre- and post-fader), as will the AFL SOLO. The PFL SOLO will continue to provide a signal when a channel is muted.

The LED next to the MUTE switch lights to let you know when the MUTE function is active.

The Mix.220FX has a dual-purpose MUTE/ALT 3-4 switch. This is a Mackie signature, and now a TAPCO signature. When Greg was designing one of the first Mackie products, he had to include a mute switch for each channel. Mute switches do just what they sound like they do. They turn off the signal by "routing" it into oblivion. "Gee, what a waste," Greg reasoned. "Why not have the mute button route the signal somewhere else useful, like a separate stereo bus?" So MUTE/ALT 3-4 really serves two functions—muting (often used during mixdown or live shows), and signal routing (for multitrack and live work) where it acts as an extra stereo bus.

To use this as a MUTE switch, all you have to do is not use the ALT 3-4 outputs [53]. Then, whenever you assign a channel to these unused outputs, you'll also be disconnecting it from the MAIN MIX, effectively muting the channel. The MUTE switch also disconnects the channel from the AUX SEND 2 bus (and the AUX SEND 1 bus when the PRE [12] switch is up). The channel's signal is still present on the AUX SEND 1 bus when the PRE switch is engaged.

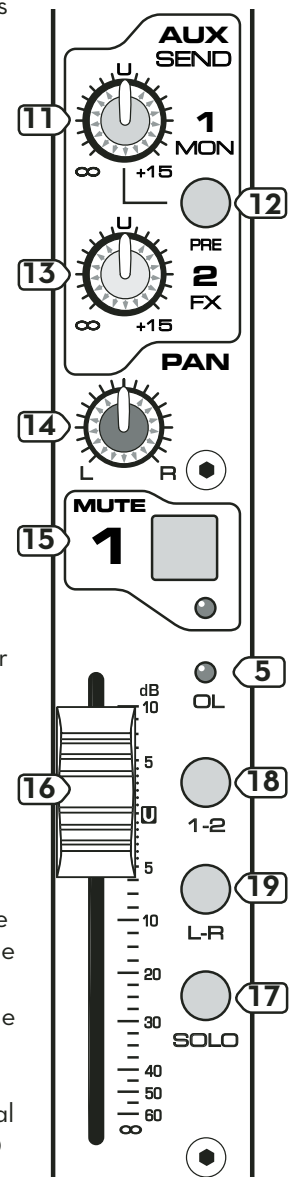

Mix.260FX Mono Channel

To use this as an ALT 3-4 switch, all you have to do is connect the ALT 3-4 outputs [53] to whatever destination you desire. Two popular examples:

When doing multitrack recording, you can use the ALT 3-4 outputs as a stereo or dual-mono feed to your multitrack.

When doing live sound or mixdown, it's often handy to control the level of several channels with one knob. That's called subgrouping. Simply assign these channels to the ALT 3-4 mix, engage ALT 3-4 [22] in the CONTROL ROOM/PHONES SOURCE matrix, and the signals will appear at the CONTROL ROOM [55] and PHONES [50] outputs.

If you want the ALT 3-4 signals to go back into the MAIN MIX, patch the ALT 3-4 OUT [53] back into an unused stereo channel (5-6 or 7-8). If that's your choice, don't ever engage the MUTE/ALT 3-4 switch on that stereo channel, or you'll have every dog in the neighborhood howling at your feedback loop.

Another benefit of the ALT 3-4 feature is that it can act as an "AFL" (After Fader Listen). Just engage a channel's MUTE/ALT 3-4 switch and the ALT 3-4 [22] switch in the CONTROL ROOM SOURCE matrix and you'll get that channel, all by itself, in the CONTROL ROOM [55] and PHONES [50].

MUTE/ALT 3-4 is one of those features that can bewilder newcomers, so take your time and play around with it. Once you've got it down, you'll probably think of a hundred uses for it!

16. Fader

This is the master level control for the channel's signal. Subtle adjustment of the channels' fader control is the key to a finely-tuned mix.

Typically (providing the GAIN is set correctly), this will be positioned somewhere around 0 dB (U).

If you have the fader set all the way up, it's usually a sign that your GAIN is set too low. If fader is set way down, your GAIN may be too high.

17. SOLO

This handy switch allows you to hear signals through your headphones or control room outputs without having to route them to the MAIN or ALT 3-4 mixes. Folks use solo in live work to preview channels before they are let into the mix, or just to check out what a particular channel is up to anytime during a session. You can solo as many channels at a time as you like. The OL LED [5] lights continuously to indicate when the SOLO switch is active (as well as the RUDE SOLO LED located just above the meters).

Your MIX FX Series has "Dual-Mode Solo." A switch in the master section, SOLO MODE [25] determines which mode you'll be hearing. With the switch

up, you'll get "PFL" (Pre-Fader Listen), which is after the GAIN and EQ controls, but before the channel fader. With the switch down, you're in "AFL" (After-Fader Listen), which is post-fader and post-PAN/BAL, making it ideal for mixdown soloing.

Soloed channels are sent to the CONTROL ROOM, PHONES, and Meters. Whenever SOLO is engaged, all CONTROL ROOM SOURCE selections – MAIN MIX, CD/TAPE, ALT 3-4 (Mix.220FX only), and SUB 1-2 (Mix.260FX only) – are defeated, to allow the soloed signal to do just that—solo!

18. Sub 1-2 Assign Switch (Mix.260FX only)

This switch assigns the channel to the Sub 1 and 2 buses. The PAN/BAL [14] control adjusts how much of the signal is sent to each bus. When the PAN/BAL control is centered, Sub 1 and 2 receive equal signal levels, while full left is Sub 1 only and full right is Sub 2 only.

19. L-R Assign Switch (Mix.260FX only)

This switch assigns the channel to the Left and Right Main Mix buses. This switch must be pushed in to get the channels' signal through to the main outs. An alternative routing is to push in the SUB 1-2 assign switch and the SUB ASSIGN TO MAIN MIX [41] switches.

CONTROL ROOM SECTION

20. MAIN MIX Switch

Use this switch to route the Main Mix signals to the CONTROL ROOM outputs, PHONES, and METERS.

When this switch is pushed in, they all receive the main mix signal tapped after the MAIN MIX control.

21. CD/TAPE Switch

Push this switch to route the CD/TAPE input signal to the CONTROL ROOM outputs, PHONES, and METERS.

22. ALT 3-4 (Mix.220FX) or SUB 1-2 (Mix.260FX) Switch

Push this switch to route the ALT 3-4 signal or the SUB 1-2 signal to the CONTROL ROOM outputs, PHONES, and METERS.

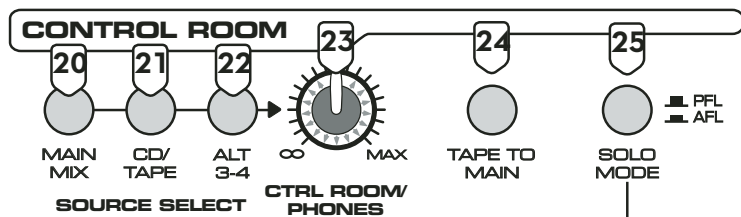

23. CTRL ROOM/PHONES Knob

This adjusts the signal level going to the CONTROL ROOM [55] and PHONES [50] outputs. It has no effect on the Main Mix output.



WARNING: The headphone amp is designed to drive any standard headphones to a very loud level. We're not kidding! It can cause permanent hearing damage. Even intermediate levels may be painfully

loud with some headphones. BE CAREFUL! Always start with the CTRL ROOM/PHONE knob turned all the way down before connecting headphones to the PHONES jack. Keep it down until you've put on the headphones. Then turn it up slowly. Why? Always remember: **"Engineers who fry their ears, find themselves with short careers."**

24. TAPE TO MAIN Switch

If you have a CD or Tape Deck connected to the CD/TAPE inputs, push down this switch to add the CD/TAPE signal to the main mix. This is useful if you want to play some entertainment* while the band is taking a break. Use the MAIN MIX controls to adjust the volume level.

* We do not mean to imply that your band isn't entertaining, or that any other music could possibly fill in for them.

25. SOLO MODE PFL/AFL

Engaging a channel's SOLO switch will cause this dramatic turn of events: Any existing CONTROL ROOM SOURCE selections are replaced by the SOLO signal, appearing at the CONTROL ROOM OUTPUTS, PHONES and at the RIGHT METER (LEFT and RIGHT METERS when in AFL SOLO MODE). The audible SOLO levels are then controlled by the CTRL ROOM/PHONES knob [23]. The SOLO levels appearing on the meters are not controlled by the CTRL ROOM/PHONES knob—you wouldn't want that. You want to see the actual channel level on the meters regardless of how loud you're listening.

With the SOLO MODE switch in the up position, you're in PFL mode, meaning Pre-Fader Listen (post-EQ). This mode is required for the "Set the Levels" procedure and is handy for quick spot-checks of channels, especially ones that have their faders turned down.

With the switch down, you're in AFL mode, meaning After-Fader Listen. You'll hear the output of the soloed channel—it will follow the channel's GAIN, EQ, FADER and PAN settings. It's similar to muting all the other channels, but without the hassle. Use AFL mode during mixdown.

In either mode, SOLO will not be affected by a channel's MUTE/ALT switch position.



Note: Be careful when switching from AFL to PFL mode. If you have the channel fader turned down very much below unity gain (U) while in AFL mode, switching to PFL mode will cause a sudden and startling increase in volume level.

26. RUDE SOLO LED

This large LED lights when a channel's solo is active, as an additional reminder beyond the indicating LEDs on each channel. If you work on a mixer that has a solo function with no indicator lights and you happen to forget you're in solo mode, you can easily be tricked into thinking that something is wrong with your mixer. Hence, the RUDE SOLO light. It's especially handy at about 3 am when no sound is coming out of your monitors but your multitrack is playing back like mad.

Note: In PFL Solo Mode, the RUDE SOLO LED is green. In AFL Solo Mode, the LED is red.

27. Meters

The peak meters are made up of two columns of LEDs, with three colors to indicate different ranges of signal level, traffic light style. They range from -30 at the bottom (-20 on the Mix.220FX), to 0 in the middle, to CLIP (+18) at the top.

The 0 LED in the middle is labeled LEVEL

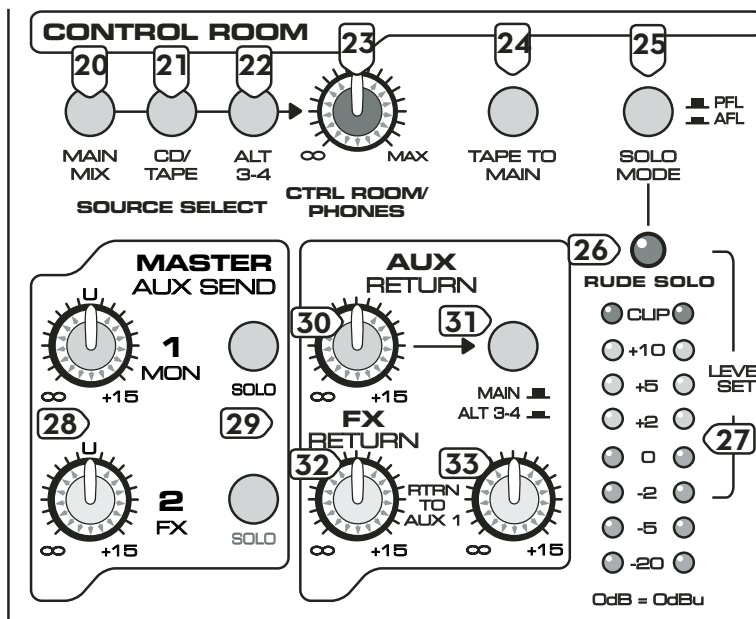

SET to show where the level should be when adjusting a channel's gain in the solo mode, as described in "Set the Levels" on page 5.

If nothing is selected in the CONTROL ROOM SOURCE SELECT and no channels are in SOLO, the meters won't do anything. To display a signal level, a source must be selected in the CONTROL ROOM SOURCE SELECT, which feeds the CONTROL ROOM [55] and PHONES [50] outputs. The meters reflect the program level of the selected source prior to the CTRL ROOM/PHONES [23] level knob.

The reason for this is because you want the meters to reflect what the engineer is listening to, and the engineer is listening either to the CONTROL ROOM outputs or the PHONES outputs. The only difference is that while the listening levels are controlled by the CTRL ROOM/PHONES knob, the meters indicate the SOURCE mix before those knobs, giving you the real facts at all times, even if you're not listening at all.

When a channel is soloed, the meters change to reflect the level of that channel's signal level, pre- or post-fader, depending on the SOLO MODE [25] setting.



You may already be an expert at the world of "+4" (+4 dBu=1.23 V) and "-10" (-10 dBV=0.32 V) operating levels. What makes a mixer one or the other is the relative 0 dB VU (or 0 VU) chosen for the meters. A "+4" mixer, with +4 dBu pouring out the back will actually read 0 VU on its meters. A "-10" mixer, with a -10 dBV signal trickling out will read, you guessed it, 0 VU on its meters. So when is 0 VU actually 0 dBu? Right now!

TAPCO mixers show things as they really are. When 0 dBu (0.775 V) is at the outputs, it shows as 0 dB VU on the meters. What could be easier? By the way, the most wonderful thing about standards is that there are so many to choose from.

Thanks to the MIX FX Series' wide dynamic range, you can get a good mix with peaks flashing anywhere between -20 and +10 dB on the meters. Most amplifiers clip at about +10 dBu, and some recorders aren't so forgiving either. For best real-world results, try to keep your peaks between "0" and "+7" (" +5" on the 220.FX).

Remember, audio meters are just tools to help assure you that your levels are "in the ballpark." You don't have to stare at them (unless you want to).

AUXILIARY SECTION

28. MASTER AUX SEND Knobs

The Master AUX SEND knobs provide overall control for the aux send levels, just before the signal is delivered to the Aux Send outputs.

It ranges from off when fully counter-clockwise, to unity gain at the center detent position, to +15 dB gain when fully up.

29. MASTER AUX SEND SOLO Switches

These allow you to monitor the aux send signals in the CONTROL ROOM and PHONES outputs. This is especially handy for listening to an aux send being used to feed on-stage monitors.

30. Master AUX RETURN Level Control

This adjusts the amount of the Aux Return signal that is added to the Left and Right Main Mix buses just before the MAIN MIX [42] faders.

(Note: For additional routing options for the AUX RETURN signal, see "Assign Switch" next).

31. MAIN/ALT 3-4 Assign Switch (Mix.220FX) MAIN/SUB 1-2 Assign Switch (Mix.260FX)

When this switch is up, the Aux Return signal is routed to the Left and Right Main Mix bus. When the switch is down, the signal is routed to the Alt 3-4 (Mix.220FX) or Sub 1-2 (Mix.260FX) buses instead of the Main Mix bus.

32. Master FX RETURN Level Control

This adjusts the amount of the FX Return signal that is added to the Left and Right Main Mix buses just before the MAIN MIX [42] faders.

If there is nothing plugged into the FX RETURN Inputs, the FX Return signal comes from the Internal Effects module.

If the output from an external effects processor is plugged into the FX RETURN Inputs, the Internal Effects is disconnected and only the external effects signal is routed through the FX RETURN level control.

33. RTRN TO AUX 1 Level Control

This routes the FX RETURN signal to the AUX 1 SEND. This is not affected by the FX RETURN level control, so you can use this control to add the FX RETURN to the monitor mix independently.

The stereo effects return signal is summed to mono and routed to the AUX SEND 1 (MON) bus via this control where it is combined with the other signals at the AUX SEND 1 (MON) bus, prior to the MASTER AUX SEND 1 control [28].

INTERNAL EFFECTS

The internal effects circuit receives a mono signal from the AUX 2 FX bus, and it outputs a stereo signal onto the main mix buses.

The input signal is controlled by the MASTER AUX SEND 2 knob [28] and the FX INPUT LEVEL knob [36], while the outputs are controlled by the FX RETURN [32] knob.

Inside the processor, the analog audio is converted to digital, this is processed by the internal DSP effects processor, and the result converted into a stereo analog signal.

34. Internal Effects Select Knob

The internal effects processor has 16 great preset effects to enhance your sound, confuse cats, and upset hamsters, if that is your idea of fun. Each has been carefully modeled to represent standard effects. Note that the effects output mutes momentarily when changing effects.

35. VARIATIONS

As you rotate this control from position 1 through 16, the “strength” of the effect increases. For example, if using a reverb effect, a low number produces a short reverb time, and a larger number produces a longer reverb time.

36. FX INPUT LEVEL

This knob allows you to adjust the signal level going into the internal effects processor. As a general rule, adjust the FX INPUT LEVEL knob until you just barely see the FX OL LED [37] blink. This will give you the best signal-to-noise ratio for the effects signal.

37. FX OL

This LED indicates when you are approaching the clipping point for the digital effects processor. If you see the FX OL overload light blinking frequently, turn down the FX INPUT LEVEL knob until it just turns off during the louder passages, riffs, chords, yells, etc.

38. FX BYPASS

Press this switch in to bypass the internal effects processor, and so prevent its output from appearing on the main mix or stage monitors. The LED next to the BYPASS switch reminds you whenever the processor is bypassed.

Use BYPASS if you are not using the internal effects, or use it to quickly compare between the effective effect of effects and the effect of no effects.

MAIN MIX, SUBS, and POWER LEDs

39. ALT 3-4 Master Faders (Mix.220FX)

These faders control the level of the signals sent to the ALT 3-4 OUTS [53]. Remember, channels are routed to the ALT 3-4 OUTS when their MUTE/ALT 3-4 switch is pushed in (Mix.220FX only).

40. SUB 1-2 Master Faders (Mix.260FX)

These faders control the level of the signals sent to the SUB OUTS [54]. All channels that have their Sub 1-2 assign switch [18] pushed in appear at the SUB OUTS (Mix.260FX only).



The ALT 3-4 and SUB 1-2 signal is off when the faders are fully down, the “U” marking is unity gain, and fully up provides 10 dB of additional gain. If you are using the two ALTS or SUBS as a stereo pair, make sure that both faders “ride” together to maintain the left/right balance.

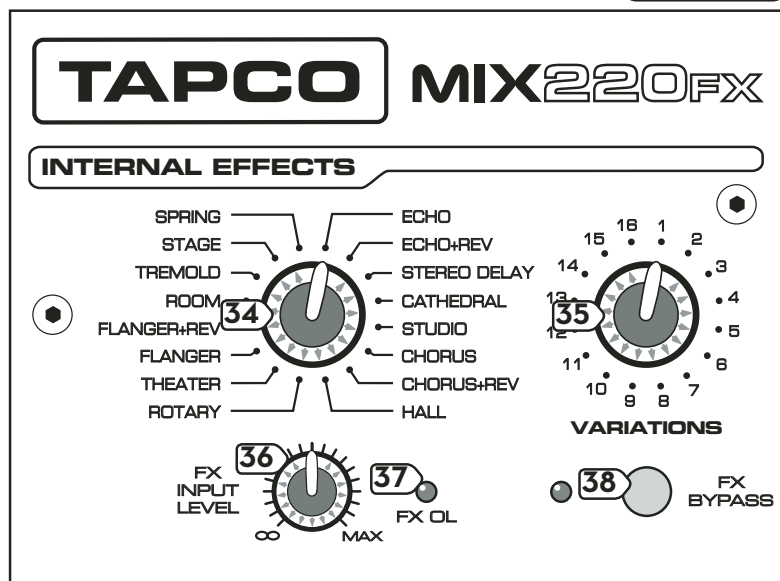

41. SUB ASSIGN TO MAIN MIX Switches (Mix.260FX only)

One popular use of the subgroups is to use them as master faders for a group of channels on their way to the MAIN MIX. Let's say you've got a drum kit using several channels and you're going to want to adjust the overall volume of just the drums with two master faders. Just un-assign these channels from the MAIN MIX, reassign them to subgroups 1-2, engage the SUB ASSIGN TO MAIN MIX LEFT on subgroup 1 and SUB

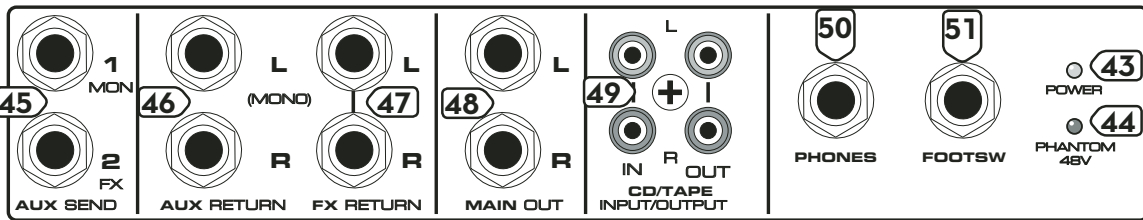

ASSIGN TO MAIN MIX RIGHT on subgroup 2. Now you can ride the entire drum mix with two faders—subgroups 1 and 2.

If you engage just one SUB ASSIGN TO MAIN MIX button per subgroup (LEFT or RIGHT), the signal sent to the MAIN MIX will be the same level as the SUB OUTS. If you want the subgroup to appear in the center of the main mix, engage both the SUB ASSIGN TO MAIN MIX LEFT and RIGHT buttons. The signal will be sent to both sides.

42. MAIN MIX Faders

This controls the final level of main mix signals sent to the MAIN [52] outputs, TAPE [49] outputs, CONTROL ROOM [55], PHONES [50], and METERS [27]. So it all comes down to this one control.

Typically, the faders will be positioned somewhere between 0 dB (U) and the +5 dB position.

All active mono and stereo channels that are not turned down or muted will appear in the main mix (the L-R Assign button [19] must be engaged on the Mix.260FX). Other signals feeding this control include the STEREO AUX and FX RETURNS [46/47], and CD/TAPE IN [49] when TAPE TO MAIN [24] is pushed in.

43. POWER LED

This LED turns on when the mixer's power cord is plugged into an AC outlet and the POWER [57] switch on the rear panel is turned on.

44. PHANTOM 48V LED

This LED turns on when the mixer's PHANTOM Power [58] switch on the rear panel is turned on.

FRONT PANEL CONNECTORS

45. AUX SEND OUT 1 and 2

Connect these 1/4" TRS outputs to the inputs of an external effects processor or stage monitor amplifier.

Each channel strip has an AUX SEND 1 MON [11] and AUX SEND 2 FX [13] control knob that adjusts how much of that channel's signal appears at each of these outputs. The output from these jacks is the sum of all those active channels that have their AUX SEND knobs set to more than the minimum position.

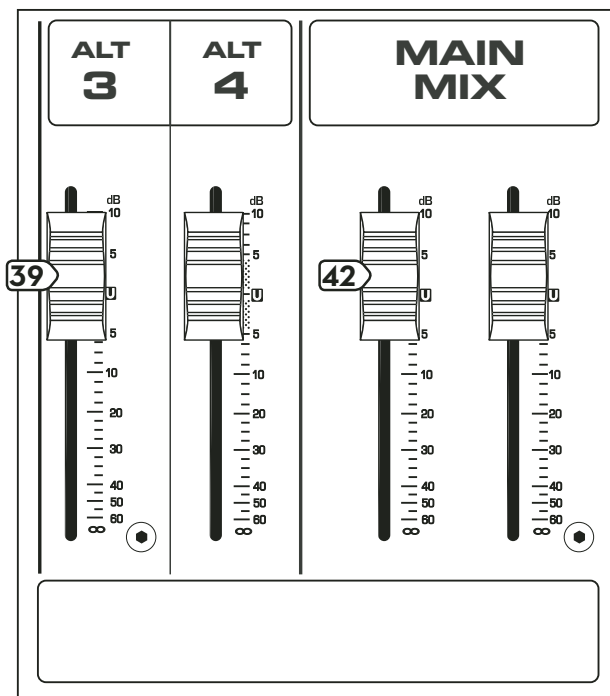

Mix.220FX ALT 3-4 and MAIN MIX

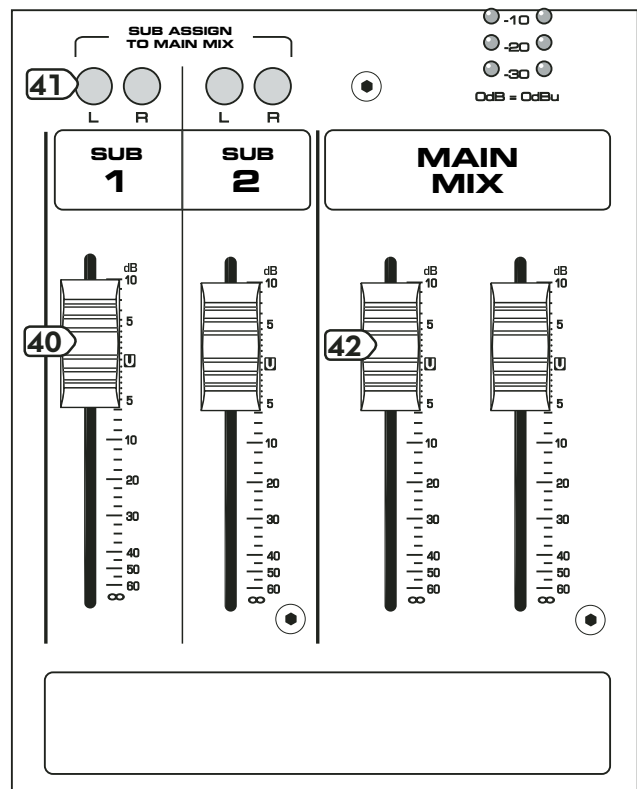

Mix.260FX SUB 1-2 and MAIN MIX

46. STEREO AUX RETURN Inputs

Connect the outputs of an external parallel effects device into these inputs.

When connecting a mono device (just one cord), always use the left (mono) input and plug nothing into the right input. The signal will appear on both sides.

The signal is added directly into the main mix (or Sub 1-2 bus on the Mix.260FX when the MAIN/SUB 1-2 switch [31] is pushed in) via the Master AUX RETURN level control [30].

47. STEREO FX RETURN Inputs

Connect the outputs of an external parallel effects device into these inputs.

Plugging a 1/4" plug into these jacks disconnects the Internal Effects processor. Note that if you plug into just the left input, the right internal effects is still connected, and vice versa. This gives you the flexibility to create some very unusual effects.

The signal is added directly into the main mix via the Master FX RETURN level control [32].

48. 1/4" MAIN OUT (Mix.260FX only)

These 1/4" TRS jacks provide a balanced or unbalanced line-level signal, where your fully mixed stereo signal enters the real world. This is the same signal that appears at the XLR MAIN OUTS [52] on the rear panel.

Connect these outputs to the inputs of your amplifiers, powered speakers, or serial effects processor (graphic equalizer, for example).

49. CD/TAPE IN/OUT

TAPE OUTPUTS

Use these jacks to capture the entire performance to tape. The signal at these jacks is a sample of the main mix, as it appears at the MAIN [52] output. The TAPE OUTPUT level is affected by the MAIN MIX [42] faders.

TAPE INPUTS

This is where you connect the outputs of your intermission entertainment. Any line-level mono or stereo device can be used, such as tape, DVD/CD player, television audio, etc.

Signals coming into these inputs are routed directly to the main mix when the TAPE TO MAIN [24] switch is pushed in. The signals can also be routed to the CONTROL ROOM [55] and PHONES

[50] outputs when the CD/TAPE [21] switch is engaged in the CONTROL ROOM SOURCE SELECT section.

When connecting a mono device (just one cord), you'll need a "Y-splitter" RCA adapter. It turns a mono output cord into two cords, so both the right and left tape input jacks can be used. This adapter is widely available.

Note: There is a chance of feedback if you have the tape inputs and outputs connected to the same recorder, and the recorder is in record mode.

50. PHONES

The stereo signal at this output jack is the same as the CTRL RM OUTS [55] outputs, and is controlled by the same CTRL ROOM/PHONES level control knob [23]. You can listen to the Main Mix, the CD/TAPE, or the ALT 3-4 (Mix.220FX) or SUB 1-2 (Mix.260FX) depending upon the CONTROL ROOM SOURCE SELECT switches.

Note: Be very careful because the PHONES jack can drive any standard headphones to very loud levels. Please see page 2 for information on hearing protection.

51. FOOTSW

This 1/4" TS jack allows you to connect a standard footswitch for engaging the Internal FX BYPASS [38] function. Note that the indicator light next to the FX BYPASS switch illuminates when the bypass function is engaged.

REAR PANEL FEATURES

52. XLR MAIN OUTS

These male XLR connectors provide a balanced line-level signal that represent the end of the mixer chain, where your fully mixed stereo signal enters the real world. Connect these to the inputs of your main power amplifiers, powered speakers, or serial effects processor (like a graphic equalizer or compressor/limiter).

53. ALT 3/4 OUTS (Mix.220FX)

These 1/4" TRS jacks provide the outputs for the ALT 3 and 4 signals. These can be connected to the inputs of a recording device, or to secondary amplifiers for an alternate mix.

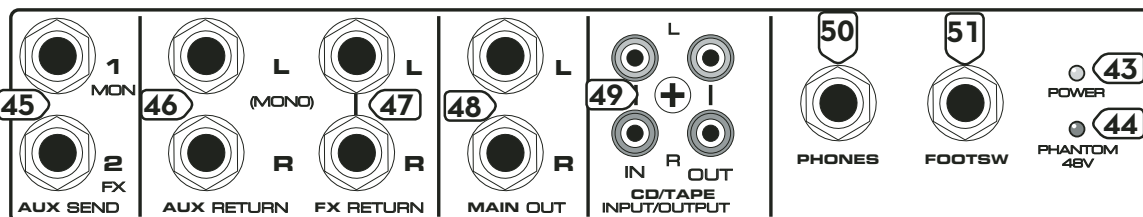

54. SUB OUTS (Mix.260FX)

These 1/4" TRS jacks provide the outputs for the SUB 1 and 2 signals. These can be connected to the inputs of a recording device, or to secondary amplifiers for an alternate mix.

55. CTRL RM OUT

These 1/4" TRS jacks can be used to provide another main mix output, or to monitor the CD/TAPE Inputs (CD/TAPE switch pushed in), or to monitor the ALT 3-4 (Mix.220FX only) or the SUB 1-2 output (Mix.260FX only).

Connect these outputs to the inputs of an amplifier, powered speakers, or recording device.

56. CHANNEL INSERTS 1-4 (Mix.260FX only)

These 1/4" TRS jacks provide a send and return point for channels 1-4. Use the CHANNEL INSERT jacks to connect serial effects devices such as compressors, equalizers, de-essers, or filters to each individual channel.

The INSERT points are after the GAIN and Low Cut controls, but before the EQ and Fader controls. The send (tip) is low-impedance, capable of driving any device. The return (ring) is high-impedance and can be driven by almost any device.

Special insert cables are available, specially designed for this kind of insert jack. They are wired as follows:

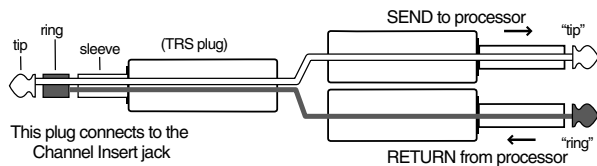

- Tip = Send (output to effects device)
- Ring = Return (input from effects device)
- Sleeve = Common ground (connect shield to all three sleeves)

Besides being used for inserting external devices, these jacks can also be used as channel direct outputs; post-GAIN, post-LOW CUT, and pre-EQ.

57. POWER ON

This one is self-explanatory. When the POWER switch is turned ON, power is supplied to the MIX FX Series mixer and the power LED on the front panel lights up.

58. PHANTOM ON

Turn on this switch to provide phantom power to all four MIC INPUT [1] XLR jacks. Phantom power is required to operate most condenser microphones (some condenser microphones are battery-powered). With the switch turned on, the mixer provides +48 VDC phantom powering on XLR pins 2 and 3.

If you have ribbon mics, tube mics, or dynamic mics that do not require phantom power, leave the PHANTOM POWER switch out. If you are using both condenser and dynamic mics, don't worry. Phantom power will not hurt most dynamic mics. Check the microphone's user manual if you're not sure.

Caution: Turn all output levels down before operating this switch to avoid the possibility of a "pop" in your speakers. Do not use phantom power with tube or ribbon microphones, as this may cause damage.

59. Power Receptacle and Fuse

This is a standard 3-prong IEC power connector. Connect the detachable linecord (included in the box with your MIX FX Series mixer) to the power receptacle, and plug the other end of the linecord into an AC outlet properly configured with the voltage required for your particular model (100-120 VAC or 220-240 VAC).

The fuse is located behind the fuse cover, at the bottom of the IEC socket. See the "Troubleshooting" section on page 12 for information about replacing the fuse.

60. Kensington Security Slot

To help prevent theft, all the MIX FX Series mixers have a security slot designed to fit the popular Kensington security locks. A variety of models are available from their website at www.kensington.com.

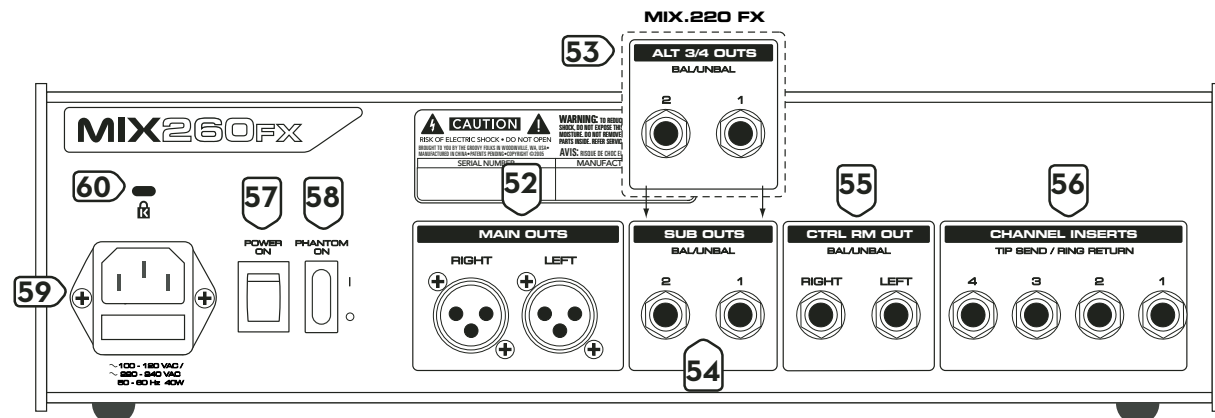

APPENDIX A: SERVICE INFORMATION

Warranty Service

Details concerning Warranty Service are spelled out in the Warranty section on page 27.

If you think your TAPCO mixer has a problem, please do everything you can to confirm it before calling for service. Doing so might save you from the deprivation of your mixer and the associated suffering.

These may sound obvious to you, but here are some things you can check. Read on.

Troubleshooting

No Power

- Our favorite question: Is it plugged in? Make sure the AC outlet is live (check with a tester or lamp).
- Our next favorite question: Is the POWER switch on? If not, try turning it on.
- Is the red POWER LED illuminated? If not, make sure the AC outlet is live. If so, refer to “Bad Channel” and “Bad Output” below.
- Is the fuse blown? If the POWER LED on the front panel is not illuminated and you are certain that the AC outlet is live, it is possible the fuse has blown.

To remove and replace the fuse:

1. Disconnect the linecord from the IEC socket.
2. Remove the fuse drawer by prying it open with a small screwdriver. It will slide all the way out.

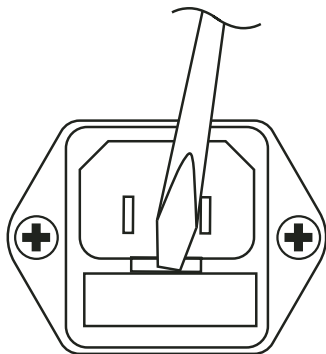

3. Remove the fuse and replace it with an equivalent type fuse:
1.6 amp slo-blo (T1.6 A/250V)

4. Replace the fuse drawer by pushing it all the way back into the IEC socket.
5. Reconnect the line cord and turn the POWER switch on.

If two fuses blow in a row, then something is wrong. See the “Repair” section on the next page to find out what to do.

Bad Channel

- Is the channel GAIN turned up?
- Is the channel LEVEL turned up?
- Try the same source signal in another channel, set up exactly like the suspect channel.

Bad Output

- IS the MAIN MIX control turned up?
- If it's a stereo pair, try switching them around. For example, if a left output is presumed dead, switch the left and right cords, at the mixer end. If the left speaker is still dead, it's not the mixer.

Noise

- Turn the channel LEVEL controls down, one by one. If the noise disappears, it's either that channel or whatever is plugged into it, so unplug whatever that is.

Repair

Service for TAPCO mixers is available at a factory-authorized service center. Service for TAPCO mixers living outside the United States can be obtained through local dealers or distributors.

If your mixer needs service, follow these instructions:

1. Review the preceding troubleshooting suggestions. Please.
2. Call Tech Support at 1-877-827-2669, 7 am to 5 pm PST, to explain the problem and obtain a Service Request Number. Have your mixer's serial number ready.
You must have a Service Request Number before you can obtain factory-authorized.
3. Keep this owner's manual. We don't need it to repair the mixer.
4. Pack the mixer in its original package, including endcaps and box. This is **VERY IMPORTANT**. When you call for the Service Request Number, please let Tech Support know if you need new packaging. You can order new packaging through our parts department. *TAPCO is not responsible for any damage that occurs due to non-factory packaging.*
5. Include a legible note stating your name, shipping address (no P.O. boxes), daytime phone number, RA number, and a detailed description of the problem, including how we can duplicate it.

6. Write the Service Request Number in **BIG PRINT** on top of the box. Units sent to us without the Service Request Number will be refused.
7. Tech Support will tell you where to ship the amplifier for repair. We suggest insurance for all forms of cartage.
8. We'll try to fix the mixer within five business days. Ask Tech Support for the latest turn-around times when you call for your Service Request Number. The mixer must be packaged in its original packing box, and must have the Service Request Number on the box. Once it's repaired, we'll ship it back the same way in which it was received. This paragraph does not necessarily apply to non-warranty repair.

Note: You must have a sales receipt from an Authorized TAPCO Dealer to qualify for a warranty repair.

Lonely? Looking for that special someone?

Do you have a question about your TAPCO Mixer?

Please call our Technical Support chaps at **1-877-827-2669**, Monday to Friday, from 7 am to 5 pm PST. After hours, visit www.tapcogear.com and look under **Support**, or e-mail us at techmail@tapcogear.com

APPENDIX B: CONNECTIONS

XLR Connectors

The Mic/Line Channels use 3-pin female XLR connectors on the MIC inputs. They are wired as follows, according to standards specified by the AES (Audio Engineering Society).

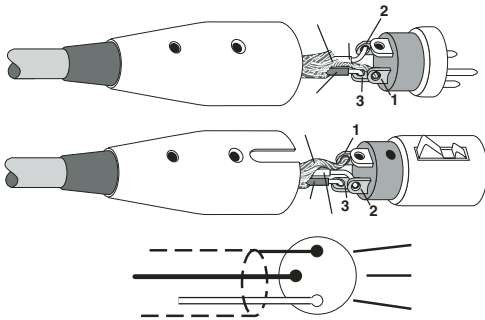

XLR Balanced Wiring:

- Pin 1 = Shield
- Pin 2 = Hot (+)
- Pin 3 = Cold (-)

1/4" TS Phone Plugs and Jacks

"TS" stands for Tip-Sleeve, the two connections available on a mono 1/4" phone jack or plug. They are used for unbalanced signals.

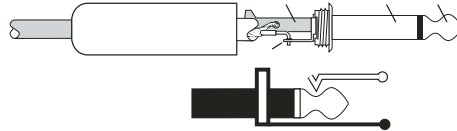

1/4" TS Unbalanced Wiring:

- Sleeve = Shield
- Tip = Hot (+)

RCA Plugs and Jacks

RCA-type plugs (also known as phono plugs) and jacks are often used in home stereo and video equipment and in many other applications. They are unbalanced and electrically equivalent to a 1/4" TS phone plug.

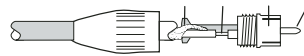

RCA Unbalanced Wiring:

- Sleeve = Shield
- Tip = Hot

1/4" TRS Phone Plugs and Jacks

"TRS" stands for Tip-Ring-Sleeve, the three connections available on a stereo 1/4" or balanced phone jack or plug. TRS jacks and plugs are used for balanced signals and stereo headphones:

Balanced Mono

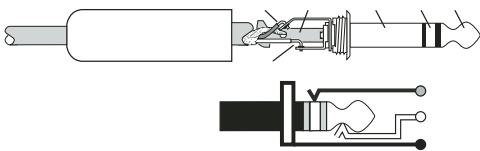

1/4" TRS Balanced Mono wiring:

- Sleeve = Shield
- Tip = Hot (+)
- Ring = Cold (-)

Stereo Headphones

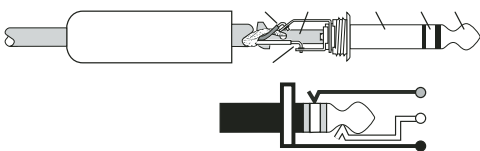

1/4" TRS Stereo Unbalanced Wiring:

- Sleeve = Shield
- Tip = Left
- Ring = Right

APPENDIX C: MIX FX SERIES SPECIFICATIONS

Frequency Response

Mic Input to any Output (Trim at 0 dB):
+0, -1 dB,
10 Hz to 150 kHz
-3 dB,
10 Hz to 200 kHz

Distortion

THD and SMPTE IMD; 20Hz to 20kHz
Mic Input to Main Output:
< 0.005%
@ +4 dBu output

Noise

20 Hz to 20 kHz BW (150Ω source impedance)
Equivalent Input Noise (EIN): -129 dBu
Residual Output Noise:
Channel and Main Mix levels off
Main, Ctrl Room, Phones: -105 dBu

Common Mode Rejection Ratio (CMRR)

Mic In: 60 dB @ 1 kHz
Gain @ maximum

Crosstalk

Adjacent Inputs or Input to Output:
-90 dB @ 1 kHz

Input Gain Control Range

0 dB to +50 dB

Phantom Power

+48 VDC

Equalization

Mix.220FX:
High ±15 dB @ 12 kHz
Mid ±15 dB @ 2.5 kHz
Low ±15 dB @ 80 Hz
Mix.260FX (Mono Channels):
High ±15 dB @ 12 kHz
Mid ±15 dB, sweepable
from 100 Hz to 8 kHz
Low ±15 dB @ 80 Hz
Mix.260FX (Stereo Channels):
High ±15 dB @ 12 kHz
Mid ±15 dB @ 3 kHz
Mid ±15 dB @ 500 Hz
Low ±15 dB @ 80 Hz

Mixer Rated Output

Main, Aux, Control Room: +4 dBu
Maximum Rated Output: +22 dBu

Maximum Input Levels

Mic Input: +12 dBu,
Gain @ +10 dB
Line Input: +30 dBu,
Gain @ +10 dB
Tape Input and Aux Returns: +22 dBu

Input Impedance

Mic Input: 2.6 kΩ, balanced
Line Input: 20 kΩ, balanced
Stereo Aux Returns: 20 kΩ, balanced
CD/Tape In: 24 kΩ, unbalanced

Output Impedance

Main 240 Ω, balanced
120 Ω, unbalanced
Ctrl Room, Aux Sends: 120 Ω
Tape Output: 1 kΩ
Phones Output: 25 Ω

VU Meters

Main Left and Right
Mix.220FX
8 segments: Clip (+18), +10, +5, +2, 0, -2, -5, -20
0 LED = 0 dBu
Mix.260FX
12 segments: Clip (+18), +10, +7, +4, +2, 0, -2, -4,
-7, -10, -20, -30
0 LED = 0 dBu

AC Power Requirements

Power Consumption: 40 watts
U.S. 120 VAC, 60 Hz
Europe 240 VAC, 50 Hz
Japan 100 VAC, 50/60 Hz
Korea 220 VAC, 60 Hz
AC Connector: 3-pin IEC 250 VAC

Physical Dimensions and Weight

Mix.220FX

Height: 3.8 in/96 mm
 Width: 11.5 in/292 mm
 Depth: 14.2 in/360 mm
 Weight: Approx. 8.8 lb/4.0 kg

Mix.260FX

Height: 3.8 in/96 mm
 Width: 13.7 in/348 mm
 Depth: 15.1 in/384 mm
 Weight: 9.8 lb/4.4 kg

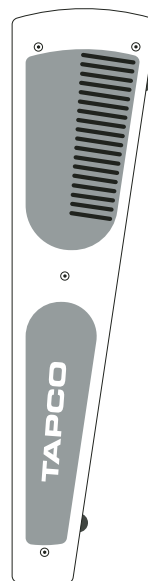
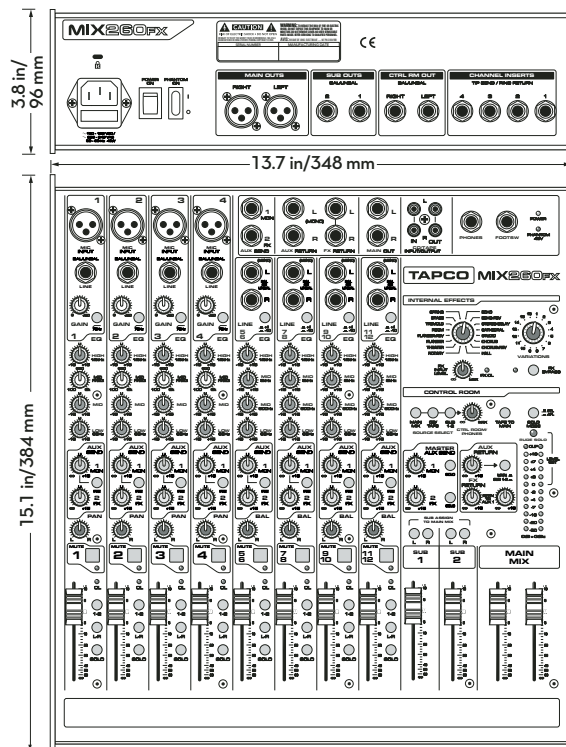
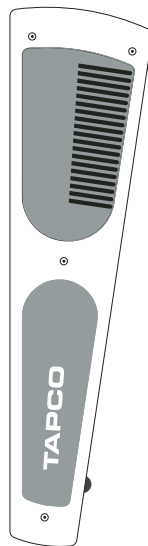
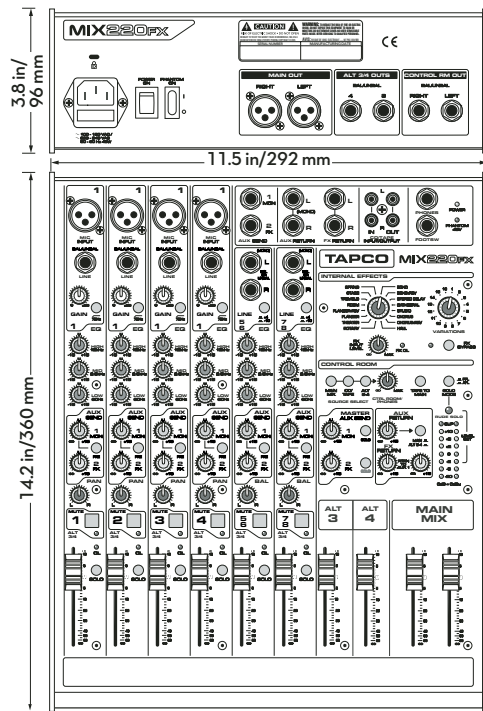

Disclaimer

Since we are always striving to make our products better by incorporating new and improved materials, components, and manufacturing methods, we reserve the right to change these specifications at any time without notice.

The TAPCO Mix mixers were recently accidentally awarded first prize by the Society of Juicers, Mixers and Blenders in the "Quadruple Planetary Mixers" category.

"TAPCO" is a registered trademark of LOUD Technologies Inc. All other brand names mentioned are trademarks or registered trademarks of their respective holders, and are hereby acknowledged.

©2005 LOUD Technologies Inc.
 All Rights Reserved.

Block Diagram Mix.220FX

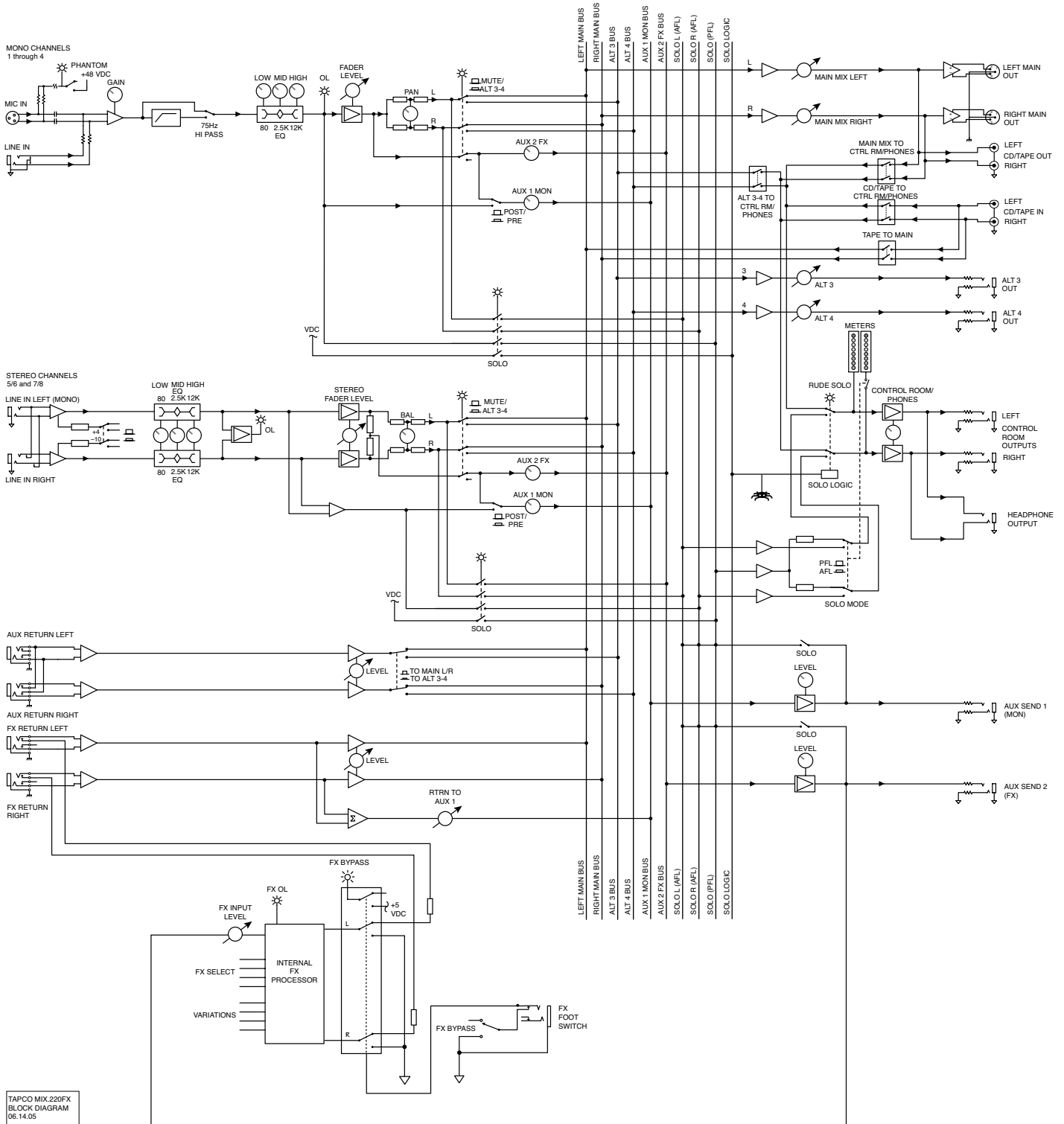

TAPCO MIX 220FX
BLOCK DIAGRAM
06.14.05

Block Diagram Mix.260FX

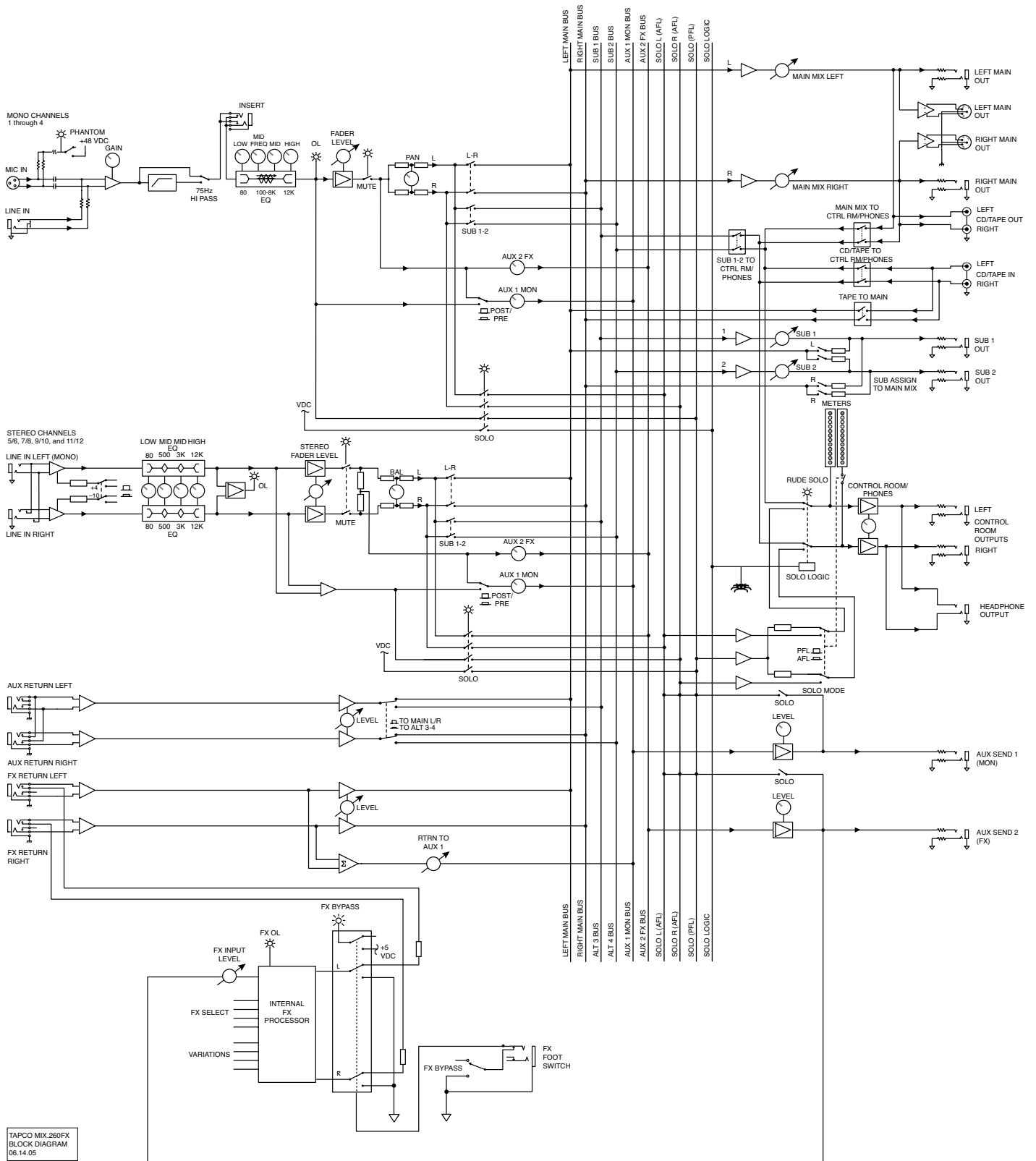

TAPCO MIX.260FX
BLOCK DIAGRAM
06.14.05

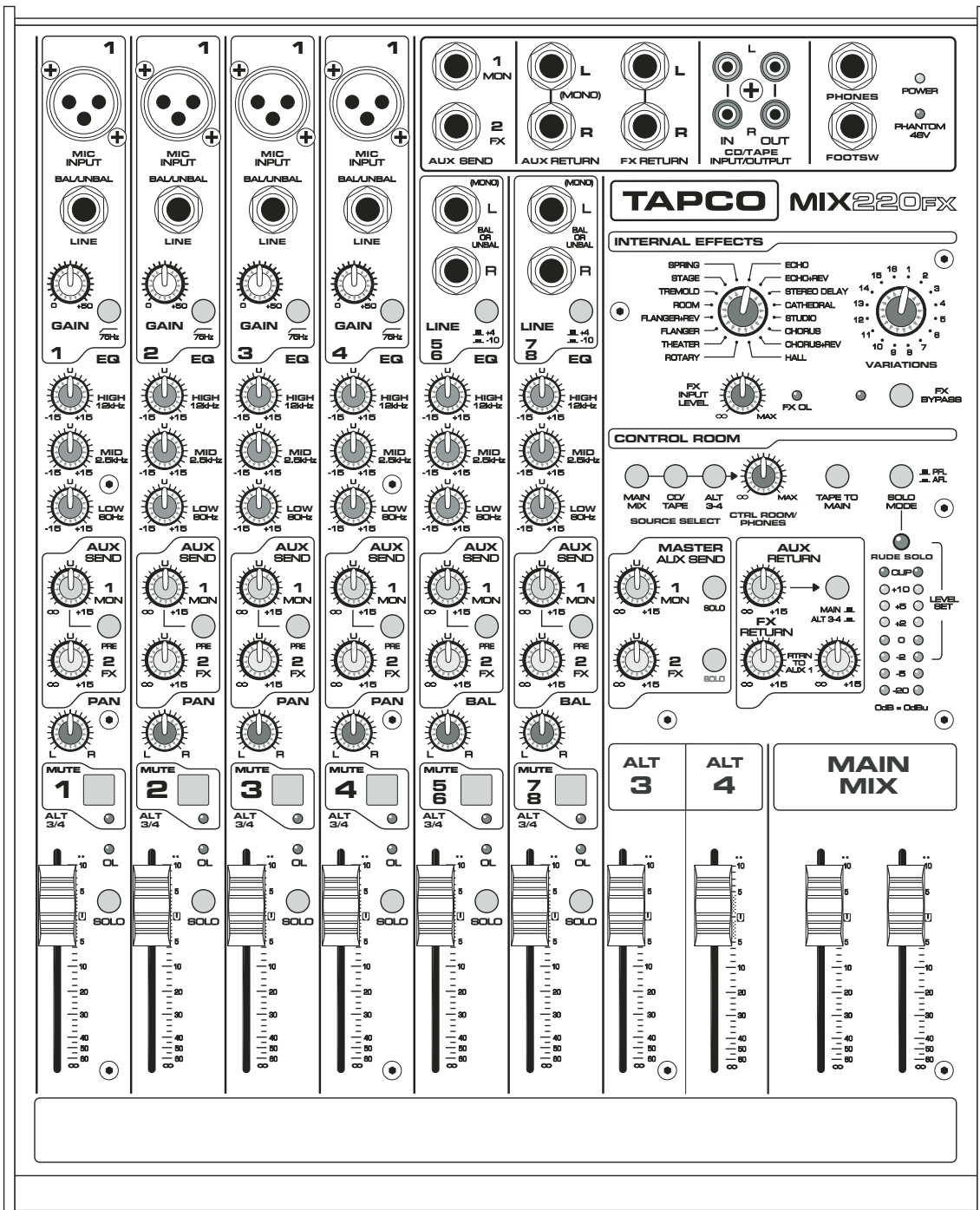
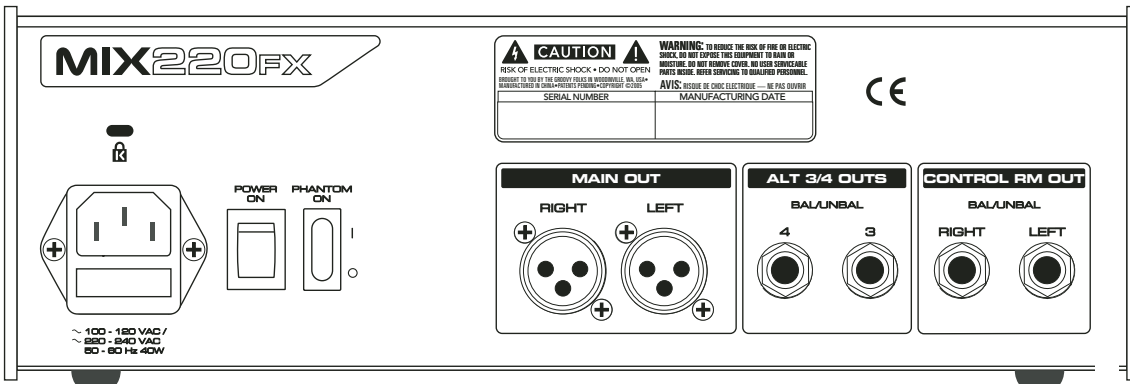

MIX260FX

CAUTION RISK OF ELECTRIC SHOCK • DO NOT OPEN
 RISK OF ELECTRIC SHOCK • DO NOT OPEN
 WARRING: TO AVOID THE RISK OF FIRE OR ELECTRIC SHOCK, DO NOT EXPOSE THIS EQUIPMENT TO RAIN OR MOISTURE. DO NOT REMOVE COVER, UNLESS QUALIFIED PERSONNEL. ALWAYS UNPLUG THIS EQUIPMENT FROM THE WALL BEFORE SERVICING.
 SERIAL NUMBER: _____ MANUFACTURING DATE: _____

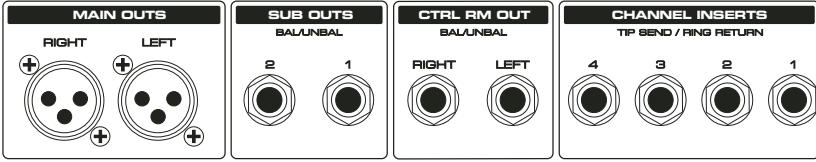
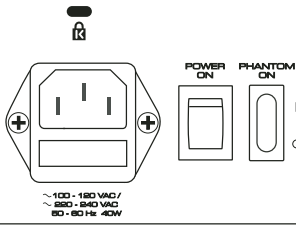

TAPCO MIX260FX

INTERNAL EFFECTS

SPRING STAGE ECHO ECHOREV
 TREMOLO ROOM BITERED DELAY 15 16 1 2
 ROOM CATHEDRAL 13 14
 FLANGERREV STUDIO 11 12
 FLANGER CHORUS
 THEATER CHORUSREV
 ROTARY HALL

FX INPUT LEVEL FX OL FX BYPASS

CONTROL ROOM

MAIN MIX COV TAPE SUB 1-2 MAX TAPE TO MAIN SOLO MODE
 SOURCE SELECT CTRL ROOM/ PHONES

MASTER AUX SEND
 1 MON SOLO
 2 FX SOLO

AUX RETURN
 1 MON MAN 1-2
 2 FX WRN AUX 1 SUB 1-2

SUB ASSIGN TO MAIN MIX
 L R L R

SUB 1 SUB 2 MAIN MIX

LEVEL SET: CLIP, +10, +7, +4, +2, 0, -2, -4, -7, -10, -20, -30, -40, -50, -60, -70, -80

TAPCO LIMITED WARRANTY

- A.** LOUD Technologies Inc. warrants all materials, workmanship and proper operation of this TAPCO product for a period of **one year** from the original date of purchase. If any defects are found in the materials or workmanship, or if the product fails to function properly during the applicable warranty period, LOUD Technologies, at its option, will repair or replace the product. **This warranty applies only to equipment sold and delivered within the U.S. by LOUD Technologies or its authorized dealers.**
- B.** Failure to register online or return the product registration card will not void the one-year warranty.
- C.** Service and repairs of TAPCO products are to be performed **only** at a factory-authorized service center. Unauthorized service, repairs, or modification will void this warranty. To obtain repairs under warranty, you must have a copy of your sales receipt from the authorized TAPCO dealer where you purchased the product. It is necessary to establish purchase date and determine whether your TAPCO product is within the warranty period.
- D.** To obtain factory-authorized service:
- 1.** Call TAPCO Technical Support at 877/827-2669, 7 AM to 5 PM Monday through Friday (Pacific Time) to get a Service Request Number. Products returned without a Service Request Number will be refused.
 - 2.** Pack the product in its original shipping carton. Also include a note explaining exactly how to duplicate the problem, a copy of the sales receipt with price and date showing, and your return street address (no P.O. boxes or route numbers, please!). If we cannot duplicate the problem or establish the starting date of your Limited Warranty, we may, at our option, charge for service time.
 - 3.** Ship the product in its original shipping carton, **freight prepaid**, to the authorized service center. The address of your closest authorized service center will be given to you by Technical Support.
- IMPORTANT: Make sure that the Service Request Number is plainly written on the shipping carton.**
- E.** LOUD Technologies Inc. reserves the right to inspect any products that may be the subject of any warranty claims before repair or replacement is carried out. LOUD Technologies may, at our option, require proof of the original date of purchase in the form of a dated copy of the original dealer's invoice or sales receipt. Final determination of warranty coverage lies solely with LOUD Technologies Inc.
- F.** TAPCO products returned to one of the LOUD Technologies factory-authorized service centers and deemed eligible for repair or replacement under the terms of this warranty will be repaired or replaced within thirty days of receipt. LOUD Technologies and its authorized service centers may use refurbished parts for repair or replacement of any product. Products returned to LOUD Technologies that do not meet the terms of this Warranty will not be repaired unless payment is received for labor, materials, return freight, and insurance. Products repaired under warranty will be returned freight prepaid by LOUD Technologies to any location within the boundaries of the USA.
- G.** LOUD Technologies warrants all repairs performed for 90 days or for the remainder of the original warranty period. This warranty does not extend to damage resulting from improper installation, misuse, neglect or abuse, or to exterior appearance. This warranty is recognized only if the inspection seals and serial number on the unit have not been defaced or removed.
- H.** LOUD Technologies assumes no responsibility for the quality or timeliness of repairs performed by Authorized TAPCO Service Centers.
- I.** This warranty is extended to the original purchaser and to anyone who may subsequently purchase this product within the applicable warranty period. A copy of the sales receipt is required to obtain warranty repairs.
- J.** This is your sole warranty. LOUD Technologies Inc. does not authorize any third party, including any dealer or sales representative, to assume any liability on behalf of LOUD Technologies or to make any warranty for LOUD Technologies Inc.
- K.** THE WARRANTY GIVEN ON THIS PAGE IS THE SOLE WARRANTY GIVEN BY LOUD TECHNOLOGIES INC. AND IS IN LIEU OF ALL OTHER WARRANTIES, EXPRESS AND IMPLIED, INCLUDING THE WARRANTIES OF MERCHANTABILITY AND FITNESS FOR A PARTICULAR PURPOSE. THE WARRANTY GIVEN ON THIS PAGE SHALL BE STRICTLY LIMITED IN DURATION TO ONE YEAR FROM THE DATE OF ORIGINAL PURCHASE FROM AN AUTHORIZED TAPCO DEALER. UPON EXPIRATION OF THE APPLICABLE WARRANTY PERIOD, LOUD TECHNOLOGIES INC. SHALL HAVE NO FURTHER WARRANTY OBLIGATION OF ANY KIND. LOUD TECHNOLOGIES INC. SHALL NOT BE LIABLE FOR ANY INCIDENTAL, SPECIAL, OR CONSEQUENTIAL DAMAGES THAT MAY RESULT FROM ANY DEFECT IN THE TAPCO PRODUCT OR ANY WARRANTY CLAIM. Some states do not allow exclusion or limitation of incidental, special, or consequential damages or a limitation on how long warranties last, so some of the above limitations and exclusions may not apply to you. This warranty provides specific legal rights and you may have other rights which vary from state to state.

Please keep your sales receipt in a safe place.



... tapcogear.com



TOTAL AUDIO PRODUCTION

Free Manuals Download Website

<http://myh66.com>

<http://usermanuals.us>

<http://www.somanuals.com>

<http://www.4manuals.cc>

<http://www.manual-lib.com>

<http://www.404manual.com>

<http://www.luxmanual.com>

<http://aubethermostatmanual.com>

Golf course search by state

<http://golfingnear.com>

Email search by domain

<http://emailbydomain.com>

Auto manuals search

<http://auto.somanuals.com>

TV manuals search

<http://tv.somanuals.com>