

Modern Recording first published the following LAB REPORT in their June '78 issue. Since then, both the CP500 and CP500M have undergone significant electrical and mechanical changes which have further improved their performance.

MODERN
RECORDING

EV TAPCO®

NORMAN EISENBERG AND LEN FELDMAN

TAPCO CP500M Power Amplifier with PowerLock™

PAT. PEND.

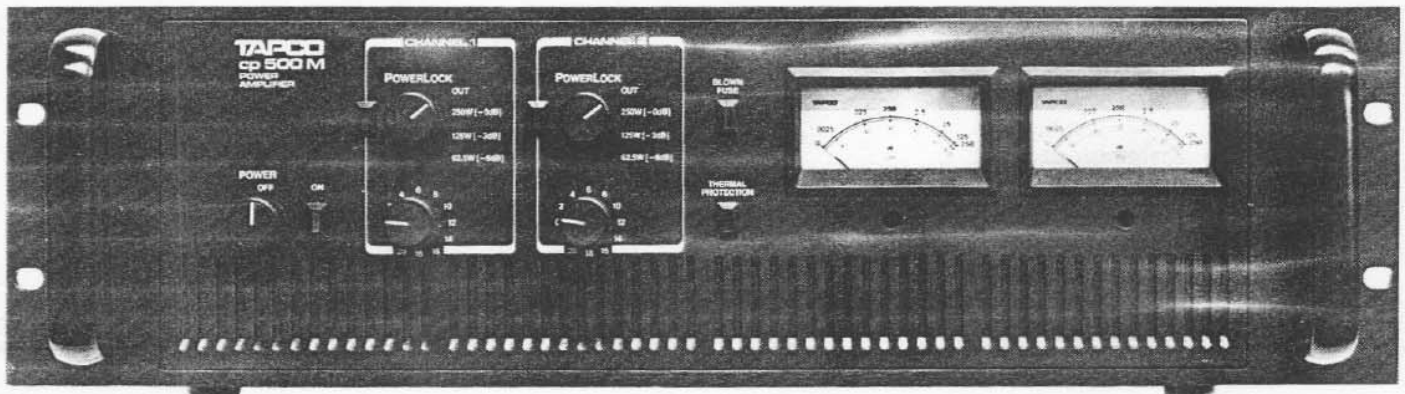

General Description: The Tapco CP500M is a two-channel power amplifier rated for up to 250 watts per channel into 4 ohms or 150 watts per channel into 8 ohms. It is of rack-mount dimensions and is fitted with handles and a built-in cooling fan at the rear. The front panel sports a pair of output meters calibrated in power ratings and in decibels, plus a "PowerLock" feature by means of which the operator can set the upper power limit furnished by the amplifier, separately on each channel.

The power off/on switch is a separate control at the left. Next to it is a power-on indicator. The two PowerLock controls have four positions: out; 250 watts (-0 dB); 125 watts (-3 dB); 62.5 watts (-6 dB). Next to each of these controls is an indicator that comes on when the upper limit selected is reached in use. Below each PowerLock control is a gain control. Two additional indicators show conditions of a blown fuse and of thermal protection.

Input connectors at the rear are standard ¼-inch phone jacks. Each channel has two bridged inputs, 20 K unbalanced. Below these jacks is a recessed slide switch for converting the amplifier to single-channel operation if desired. Speaker output terminals are standard binding posts, color-coded for polarity and arranged so as to provide for two-channel (stereo) out-

put or single-channel (mono) output. The cooling fan is centered on the rear panel. Completing the picture here are a fuse-holder with a 15-amp rating and the unit's AC power cord which is fitted with a three-prong (grounding) plug.

The PowerLock circuit, which may be used to limit output power, uses output-voltage sensing which is referred to a fixed reference voltage which in turn is a function of the supply voltage itself, so that regardless

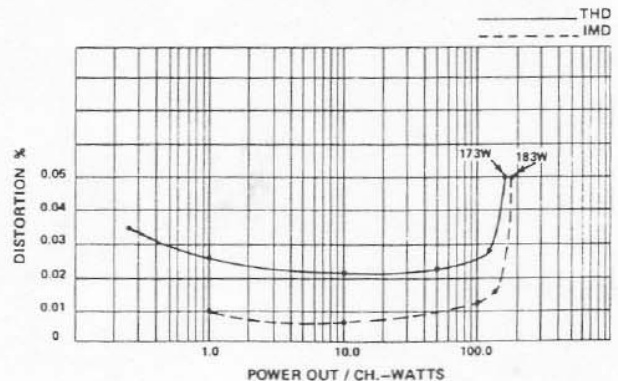

Tapco CP500M: Distortion vs. power output, into 8-ohm loads, both channels driven.

of voltage fluctuations caused by external sources, the unit simply cannot go into clipping when this circuit is employed.

The basic amplifier circuitry itself is fairly conventional in that full complementary outputs are used. The output stages do provide gain, however, unlike many other complementary designs. An input differential pair feeds signals to an emitter follower and then to a class A stage which drives the bias string. Bias sensing is accomplished at the drivers and predrivers, and it also is based on ambient temperatures sensed at the output stages. Driver and output stages constitute a Darlington configuration which has a collector-loaded output. The input stages are powered from a zener-regulated ± 18 volt supply, while the output stages operate at ± 62 volts filtered by a pair of 18,000 mFd capacitors.

Test Results: Ruggedly built, the Tapco CP500M performed in our tests better than its published specs would suggest, and in general shaped up as a first-rate powerhouse that can be recommended for demanding professional applications. In fact, performance in general (except of course for the audible fan noise) rivaled that normally expected of "hi fi" amplifiers.

Tapco, with understandable pride, advised that they precondition their amplifiers (as per FTC requirements) with 4-ohm loads, often even using a high-frequency test signal at one-third rated power (in this case, around 85 watts) for the test. They invited us to do the same, and the results of our static measurements represent readings taken after one full hour of such preconditioning. Note that the amp just missed making its 0.05 percent rated distortion at the 20-Hz extreme for 4-ohm loads, but we would hardly fault the unit for that since the difference between 0.05 percent and 0.1 percent is rather academic from an audibility standpoint.

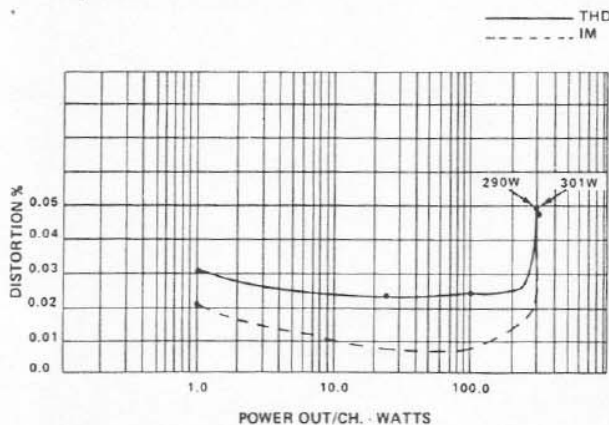

Tapco CP500M: Distortion vs. power output, into 4-ohm loads, both channels driven.

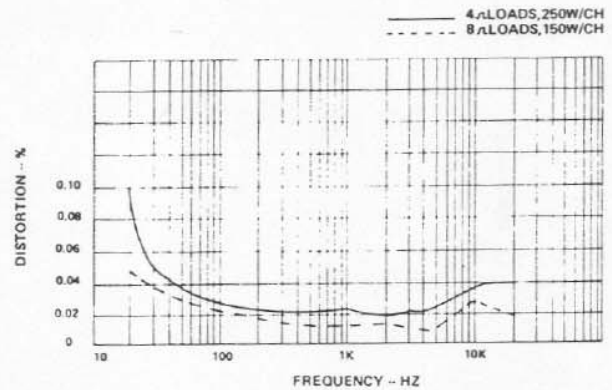

Tapco CP500M: Distortion vs. frequency at rated output.

General Info: Dimensions: 19 by 5¼ by 17 inches. Weight: 35 pounds. Also, as model CP500, less meter, fuse, and thermal indicators.

Individual Comment by L.F.: Since I test both "hi fi" amplifiers and those intended strictly for "pro" use, I usually know what differences to expect between the performance of one type and the other. While I recognize the need for extreme ruggedness in a professional power amp, I have never believed that the incorporation of such ruggedness and fail-safe features necessarily meant that the pro unit had to sacrifice performance specs that are normally expected of an "audiophile" product. Apparently Tapco agrees with me. No audio purist would ever tolerate the cooling fan noise generated by the CP500M in a home listening environment, but mounted in a rack and subjected to the kinds of environments that high power amps of this type encounter "in performance" and in sound reinforcement applications, the presence of the constantly running fan just adds that much more to the safety and long life of this ruggedly built powerhouse.

Since the amp is a wide-range unit that may find use with almost any speaker array, perhaps the smartest circuitry incorporated in it is Tapco's "PowerLock" feature, a form of precise limiter which can be preset to 62.5, 125 or 250 watts or can be turned off completely. I can't begin to guess at the number of speaker systems that are likely to be saved if this feature is used correctly.

The most impressive thing about the CP500M is its ability to deliver high orders of power output for long periods of time without thermally cycling and with no evidence of strain. Since I am an inveterate hi-fi buff, I could not resist hooking up the amp as part of a component hi-fi setup and judging it as I would judge a high-powered audiophile amp. I must confess it sounded great, exhibiting no harshness or transient distortion. Aside from the fan noise (which I didn't

bother to mask or eliminate by remote placement), had I not known that its primary applications are professional, I would have been perfectly content to live with it on a more permanent basis.

Individual Comment by N.E.: Aside from the possible annoyance of the fan noise, there is nothing about this amplifier to criticize adversely or even to question. It is a sturdy, robust piece of professional equipment and the PowerLock feature is both handy and effective. Lab measurements and listening tests

confirm that the "listening quality" of the unit rivals that of "home hi-fi" units, while ruggedness is definitely in the "pro class."

It is interesting to note that Tapco also has a somewhat smaller amplifier, the model CP120. The CP120 has the PowerLock feature but it lacks the output meters. It also lacks the cooling fan which means no kind of noise at all. We hooked this amp into a high-quality listening system and can confirm that it provides excellent drive for monitor-quality speakers in a good-size sound room.

PERFORMANCE CHARACTERISTIC	MANUFACTURER'S SPEC	LAB MEASUREMENT
Continuous power per channel, 1 kHz	250 watts into 4 ohms 150 watts into 8 ohms	290 watts into 4 ohms 173 watts into 8 ohms
Continuous power per channel 20 Hz to 20 kHz	250 watts into 4 ohms 150 watts into 8 ohms	240 watts into 4 ohms 150 watts into 8 ohms (see text)
Power bandwidth	20 Hz to 20 kHz	20 Hz to 39 kHz
Frequency response	20 Hz to 20 kHz, 0.2 dB 5 Hz to 100 kHz, -3 dB	8 Hz to 60 kHz, -1 dB 5 Hz to 110 kHz, -3 dB
Damping factor	N/A	99.2 at 8 ohms
Rated THD	0.05%	0.025%, 4 ohms 0.027%, 8 ohms
Rated IM	0.05%	0.023%, 4 ohms 0.015%, 8 ohms
Residual hum and noise	-95 dB	-98 dB
Input sensitivity	+4 dBm	+4 dBm
Power consumption	165 watts, idle 1150 watts, max	confirmed

As manufacturers of the CP500 and the CP500M, we couldn't have said it much better ourselves. It's one thing for us to know these power amplifiers are good — it's quite another thing for others to agree with us. That is why we reprinted this lab report. We wanted you to see it so you could judge for yourself. On the next page we've reprinted some of the facts about not only the CP500 and CP500M but the CP120 as well. At 61 watts into 4 ohms per channel, the CP120 is no lightweight

when it comes down to what you actually need in most professional sound reinforcement situations.

Stop in and see these power amplifiers from TAPCO at your local authorized TAPCO dealer. TAPCO builds power amplifiers for you the way they must be built: durable, tough, compatible, and clean, with fresh innovative design characteristics that add up to better performance for your money.

CP120 SPECIFICATIONS

POWER OUTPUT¹

Stereo: 61 watts minimum sine wave continuous average power per channel, both channels operating into 4 ohms over a bandwidth of 20 Hz to 20K Hz. Maximum total harmonic distortion at any power level from 250 milliwatts to 61 watts shall be no more than 0.05%.

50 watts minimum sine wave continuous average power per channel, both channels operating into 8 ohms over a bandwidth of 20 Hz to 20K Hz. Maximum total harmonic distortion at any power level from 250 milliwatts to 50 watts shall be no more than 0.05%.

Mono-bridge configuration: 122 watts minimum sine wave continuous average power, both channels operating in a bridged configuration across 8 ohms over a bandwidth of 20 Hz to 20K Hz. Maximum total harmonic distortion at any power level from 250 milliwatts to 122 watts shall be no more than 0.05%.

TOTAL HARMONIC DISTORTION

Stereo: 0.05% maximum harmonic distortion (at any power level from 250 milliwatts to 61 watts per channel into 4 ohms, or to 50 watts per channel into 8 ohms from 20 Hz to 20K Hz).

Mono: 0.05% maximum harmonic distortion (at any power level from 250 milliwatts to 122 watts into 8 ohms from 20 Hz to 20K Hz).

STATIC² and DYNAMIC³ INTERMODULATION DISTORTION

Stereo: 0.05% maximum if instantaneous peak power is 122 watts or less per channel into 4 ohms, or 100 watts or less per channel into 8 ohms for any combination of frequencies, 20 Hz to 20K Hz.

10: 0.05% maximum if instantaneous peak power is 244 watts or less into 8 ohms, operating for any combination of frequencies, 20 Hz to 20K Hz.

FREQUENCY RESPONSE

At 1 watt output

20 Hz to 20K Hz, +0 — 2 dB
5 Hz to 100K Hz, +0 — 3 dB

NOISE AND HUM

95 dB below rated output

INPUT SENSITIVITY

For stereo and mono: 1.23V (+4 dBm)

INPUT IMPEDANCE

For stereo and mono: 20K ohms minimum

OUTPUT VOLTAGES

Stereo: 15.62V per channel into 4 ohms

20V per channel into 8 ohms

Mono: 31V balanced to ground, in bridge configuration into 8 ohms

POWER REQUIREMENTS

120 volts, 60 Hz, 30 watts at zero signal output, 255 watts at rated output

SIZE (WHD)

19" (48.26 cm) X 3 1/2" (8.89 cm) X 16 1/2" (41.91 cm)

WEIGHT

18 pounds (8.16 kg)

All specifications subject to change without notice

¹TAPCO Power Ratings are in accordance with the Federal Trade Commission rulings concerning power output claims.

²Measured with SMPTE-IM method.

³Measured with CCIF Close Tone Measurement IM Test. Transient Intermodulation Distortion is a form of Dynamic Intermodulation Distortion and could be measured using Otala TDM method (3,180 Hz square wave, and 15K Hz sine wave, 4 : 1 ratio), or CCIF difference method (19K Hz and 20K Hz). For more information see: El Leinonen, M. Otala and J. Curt: A Method for Measuring Transient Intermodulation Distortion (Journal AES April 1977)

PowerLock™ (Patent Pending)

8 AMPS in 1 and Speaker Protection

TAPCO POWER AMPS WITH PowerLock™

Professionals in any trade know the value of choosing their tools wisely. The tool they buy must be designed for the job. TAPCO builds power amps for professionals the way they must be built: durable, tough, compatible, and clean, with fresh innovative design characteristics that all add up to better performance for your money.

A professional design approach to power amplifiers demands both mechanical and electrical reliability, and thermal stability. With TAPCO PowerLock™ amplifiers you get the kind of on-the-job stability and sound quality you'd expect from a product specially designed for a special job.

The TAPCO CP120 and CP500(M) with PowerLock™ are designed for critical monitoring and the most demanding sound reinforcement applications.

POWER CAPABILITY

The CP120 delivers 61 watts minimum sine wave continuous average power per channel, both channels operating into 4 ohm loads. 122 watts minimum sine wave continuous average power may be obtained into an 8 ohm load in the mono bridged configuration.

The TAPCO CP500 delivers 255 watts minimum sine wave continuous average power, per channel, both channels operating into 4 ohm loads. 510 watts minimum sine wave continuous average power may be obtained into an 8 ohm load in the mono bridged configuration.

PowerLock™ (Pat. Pending)

A very common source of distortion in amplified sound is clipping. This harsh sound, the result of asking more of an amplifier than it's able to deliver, not only destroys the clean sonics of music, but is often responsible for smoking expensive horn drivers. For this reason the CP120 and CP500 incorporate PowerLock™, a unique clipping prevention circuit. When activated, PowerLock™ eliminates any chance of prolonged amplifier clipping. Because the output is free of clipping distortion, the CP120 and CP500 are the ideal choice for both full range, and bi-amped and tri-amped systems.

The PowerLock™ time constants are set to allow normal musical transients to pass unaltered. But any longer duration signals, over 1 millisecond that is, will be reduced up to 30dB. PowerLock™ can be switched off, set for full power, half power (-3dB), or quarter power (-6dB). Your entire system sounds cleaner, and your speakers are protected from high power clipped signals.

HEAT PROTECTION

The life span of any amplifier is directly related to its ability to operate without generating potentially damaging heat, the killer of solid-state devices. In the CP120, the output devices are kept well within their safe operating temperature by convection cooled heat sinks. In the CP500, heat is conducted from the output devices by a powerful, high capacity (115 cfm) industrial grade fan. Maximum thermal benefit from fan-cooling is realized through the use of a specially designed internal tunnel that routes cool air over and around the vital output components. Individual and total heat sink areas, fan cooling in the CP500 and CP500M, and the recognition of the need for a massive safety margin; all provide very conservative operation with excellent heat dissipation capabilities. TAPCO amplifiers with PowerLock™ run cool even under full power conditions.

1 TAPCO power amplifier specifications comply with F.T.C. rating requirements.

HOW PowerLock™ WORKS

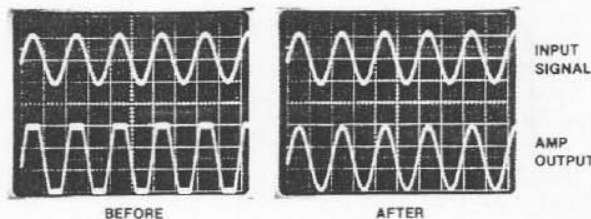

SPECIAL PROTECTION

The output circuitry is fully protected by straight current limiting. This protection circuit is there only to save the amplifier under gross fault conditions such as short circuits, very low load impedances, or overly reactive loads. The sharp cutoff characteristics of the TAPCO protection circuit keeps it completely out of the picture during normal amplifier operation. Only when the amplifier is driven beyond the call of duty is the protection circuit brought into play, so the amplifier is always positively protected from output faults without ever sacrificing sonic quality.

Additional fail-safe protection is provided by the CP120's and CP500's load relay system. When the amplifier is switched on, the relay waits until the power supply is stabilized before completing the speaker/amplifier connection. This eliminates turn-on thump. Since the relay system senses any DC voltages on the output terminals, it will automatically disconnect the speakers should any gross fault condition occur. This system completely eliminates the possibility of speaker failure from exposure to speaker-killing DC.

DISTORTION

Dynamic intermodulation distortion (DIM) is probably the most obvious and annoying kind of distortion. (Transient intermodulation distortion is only one of the many mechanisms that contribute to DIM, and is therefore included in this spec.) The very stringent CCIF Close Tone Measurement IM Test is used by TAPCO engineers to measure DIM because it relates directly to perceived sound quality.

Steady state IM distortion figures are not as easy to relate to sound quality as the DIM figures, but are included here for comparison purposes. At .05% maximum, the amps exhibit negligible steady state IM distortion.

Unfortunately, the usual THD spec expressed as a percentage fails to tell you exactly which harmonics make up that percentage. In TAPCO power amps all harmonic components fall at -90dB (.003%) or more below operating level, very near the residual noise of the test gear. No one harmonic is produced in significantly disproportionate amounts, so harmonic coloration is absolutely undetectable. THD is typically below .009%.

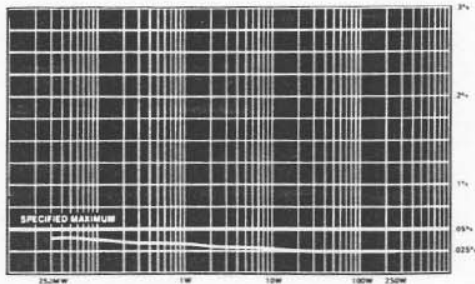

3810 - 148th AVE. N.E.
REDMOND, WA 98052
(206) 883-3510
TWX/910-449-2594

CP 500 CP 500M

CAUTION

To prevent electrical shock, do not disassemble. No user-serviceable parts inside; refer servicing to qualified service personnel. Serviceman must disconnect line cord before disassembling.

Connect a speaker to the terminals, however, and it's a different story. The amp now works against the load according to the input signal. The speaker coil converts changes in the signal to movement of the cone or diaphragm. This changing motion generates sound waves and the listener hears what's happening.

Basic hookup is this: With the POWER switch OFF, connect the amp to your preamp, mixer, or other signal source. Use the proper jumpers or cables. Then connect your speaker, speaker system, or speaker systems to the proper output terminals on the rear panel. Use wire of the correct type and adequate current-carrying capacity for speaker runs. Generally, what is called lampcord or "zipcord" by electricians is a good kind to use. Using lampcord gives you help with making sure that the plus and minus connections are made properly for speaker phasing.

Lampcord almost always has a ridge along one side, or is color coded. The ridge parallels one of the wires and is mighty handy when you want to identify which conductor is connected to the plus terminal at the amp so you can connect it to the plus terminal at the speaker. For long service life get lampcord with many strands in each conductor.

Banana plugs or open-end terminal lugs made good speaker wire ends. If you use terminal lugs, do not solder them. Crimp the wire and the wire covering in the terminal for strength. It takes some of the strain and lends support to the wire itself. Just stripping the jacket back and crimping the wire to the terminal won't give you a very long lasting connection. Repeatedly moving the wires with the terminals held rigidly under the amp's five-way output posts will quickly work-harden the conductors. Pretty soon you have many watts going through just one or two strands. Then an open circuit and no sound output.

Because one input signal is fed to both outputs, never connect either of the red terminals to ground. In fact, they should never be grounded under any circumstances. One more thing should be committed to memory: NEVER connect the two red terminals together anywhere in the output, neither at the amp nor at the speaker. Extensive amp damage may result.

Input in bridge mode operation is through the Channel 1 input jack on the rear panel. Input sensitivity of both channels is controlled by the Channel 1 level control on the front panel. Both the Channel 2 level control and input jack are disconnected in single channel operation.

This is not the case with the PowerLock™ controls, however. Now the CP500(M) is under complete control of the PowerLock™ switch for Channel 1. Turn the PowerLock™ switch for Channel 2 to its OUT position. What this does is permit the single PowerLock™ circuit to control the amp on both positive and negative transients, and longer lasting onslaughts that would otherwise send it into clipping. What you get is the same clean distortion-free sound, and peace of mind about the safety of your speakers-and at double the output.

Set Channel 1 PowerLock™ according to the chart. The amount of power selected in single channel will still be -0 dB, -3 dB, and -6 dB. The power output in the full -0 dB power position will be 510 watts. In the -3 dB position, which is half power, the power output will be 255 watts. And in the -6 dB position, quarter power, the power output will be 127.5 watts, into a minimum impedance of eight Ohms.

A special operating consideration is necessary: Because the amplifier's output is balanced (plus and minus with respect to ground), do not ground either side of the line. As stated previously in this section, do not ground the red terminals.

Channel Level Controls are provided to progressively reduce amplifier input sensitivity as they are turned counterclockwise from their full on position (maximum clockwise). They can also be termed input attenuators. Their use follows.

If you have a quiet mixer, set the level controls full on, and use the master gain controls at the mixer or preamp to set sound pressure level (volume) at the speakers. If the mixer or other control device is noisy, turn the amp's channel level controls down until the noise becomes less objectionable. Adjust the master gain and channel level controls for the best signal-to-noise ratio. Turning the amp's channel level controls down reduces your mixer's headroom. Headroom is the difference between the normal operating level and the maximum output of a unit before it clips. Headroom is usually given in dB. You want all you can get.

PowerLock™ Switches & Red LED's are used to give you clean sound up to the maximum rating of your speakers. PowerLock™ circuits, one for each channel, prevent the amplifier from ever reaching sustained clipping levels, thus regulating the maximum output power to be delivered by the amp. Clipping causes distortion in the sound output. Sustained clipping can cause speaker damage. And you know what that can do to your speakers.

In electronic terms, your CP500(M) incorporates a fast-acting limiter in the front end of each channel. The point at which the output comes under control to prevent clipping is called the limiting threshold. The threshold is set by the PowerLock™ switch, one for each channel. The circuitry actually acts before the output reaches clipping levels. The turn-on (attack) time is one millisecond (lms), which is 0.001 second. Transients with magnitudes in excess of the predetermined PowerLock™ setting, which last less than one millisecond, are not of sufficient duration to cause

ordinarily has a background sound level of about 30 dB.) Under concert conditions the average listener-person probably can't detect a 6 dB change in intensity of a particular tone.

With the PowerLock™ switch set to 125W (-3 dB) the amp output is cut to half power in that channel, 125 watts into a minimum impedance of 4 Ohms.

With the PowerLock™ switch set to 62.5W (-6 dB) the amp output is cut to quarter power in that channel. 62.5 watts into a minimum impedance of 4 Ohms.

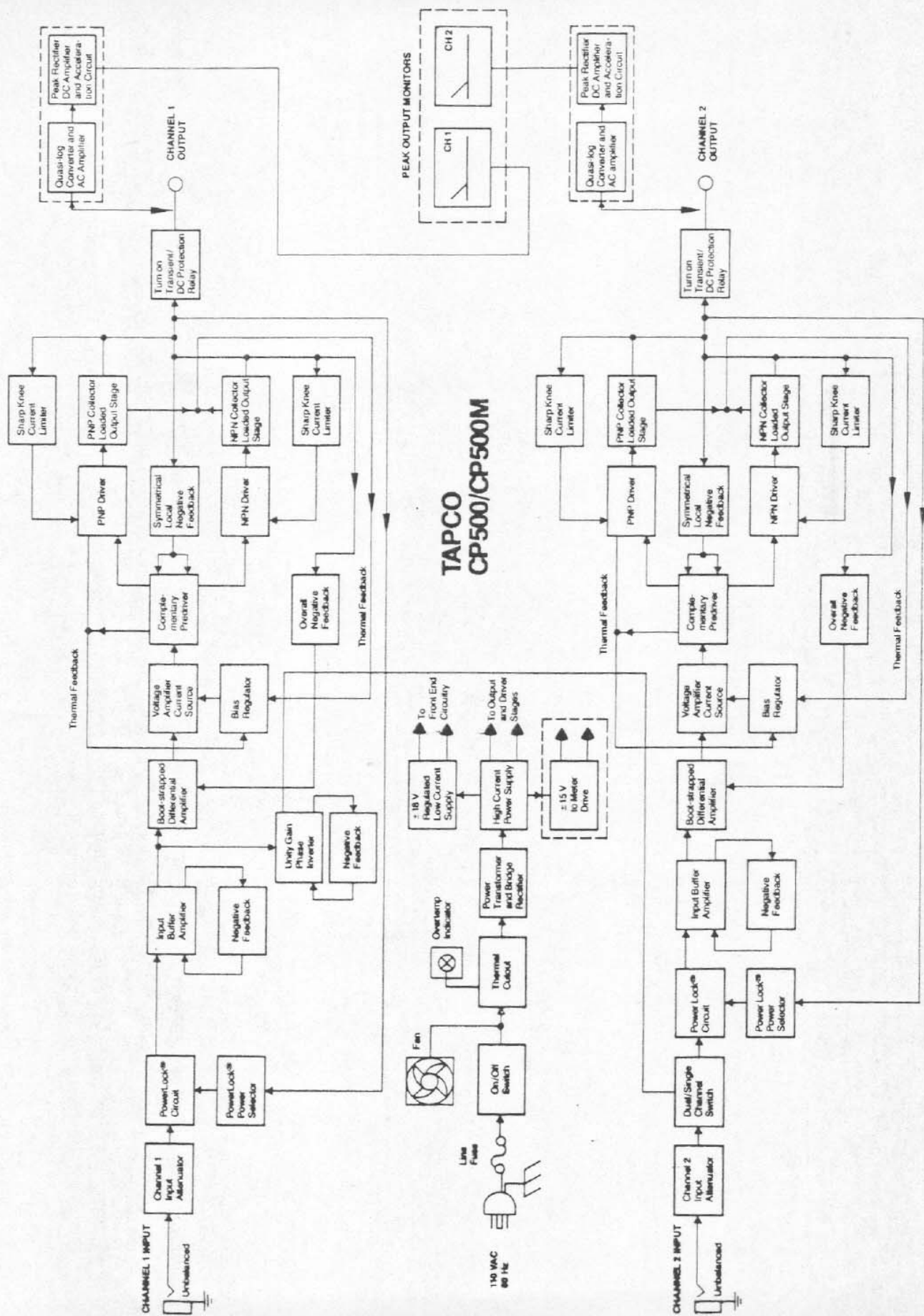

Free Manuals Download Website

<http://myh66.com>

<http://usermanuals.us>

<http://www.somanuals.com>

<http://www.4manuals.cc>

<http://www.manual-lib.com>

<http://www.404manual.com>

<http://www.luxmanual.com>

<http://aubethermostatmanual.com>

Golf course search by state

<http://golfingnear.com>

Email search by domain

<http://emailbydomain.com>

Auto manuals search

<http://auto.somanuals.com>

TV manuals search

<http://tv.somanuals.com>