

SHARP

MIKRO KOMPONENTEN SYSTEM
MICRO-CHAÎNE
SISTEMA MICRO
MIKRO KOMPONENT SYSTEM
MICRO SISTEMI
MICRO SYSTEEM
SISTEMA DE MICRO COMPONENTE
MICRO COMPONENT SYSTEM

MODELL MODELLO
MODÈLE MODEL
MODELO MODELO
MODELL MODEL

XL-UH240H
XL-UH240H (BK)
XL-UH2440H

BEDIENUNGSANLEITUNG MANUALE DI ISTRUZIONI
MODE D'EMPLOI GEBRUIKSAANWIJZING
MANUAL DE MANEJO MANUAL DE OPERAÇÃO
BRUKSANVISNING OPERATION MANUAL

CD-R/D-S

MP3

SAVING ENERGY
STAND-BY POWER CONSUMPTION **0.6w**

COMPACT
disc
DIGITAL AUDIO



USB
TERMINAL



Note:
This product is not compatible with MTP and AAC file systems.

Die Abbildungen in dieser Bedienungsanleitung sind für das Modell XL-UH240H.
Les illustrations utilisées dans ce mode d'emploi sont pour le modèle XL-UH240H.
Las ilustraciones impresas en este manual de manejo son del modelo XL-UH240H.
Bilderna i denna bruksanvisning gäller för modelltypen XL-UH240H.
Le illustrazioni stampate in questo manuale di istruzioni sono per il modello XL-UH240H.
De afbeeldingen in deze gebruiksaanwijzing zijn gebaseerd op het XL-UH240H model.
As ilustrações impressas neste manual de operações são para o modelo XL-UH240H.
The illustrations printed in this operation manual are for the model XL-UH240H.

XL-UH240H / XL-UH240H (BK)

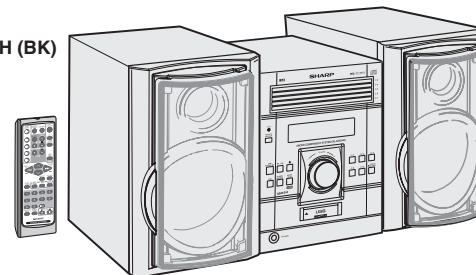

XL-UH2440H

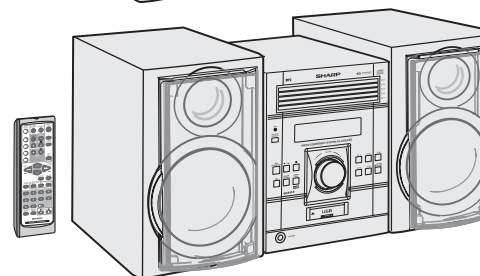

CD-R/RW
Playable **5-DISC**
CHANGER

DEUTSCH	... Siehe Seiten i bis x und D-1 bis D-40.
FRANÇAIS	... Se reporter aux pages i à x et F-1 à F-40.
ESPAÑOL	... Consulte las páginas i a x y S-1 a S-40.
SVENSKA	... Hänvisa till sidorna i till x och V-1 till V-40.
ITALIANO	... Leggere le pagine i a x e I-1 a I-40.
NEDERLANDS	... Raadpleeg de bladzijden i t/m x en N-1 t/m N-40.
PORTUGUÊS	... Favor consultar as páginas i a x e P-1 a P-40.
ENGLISH	... Please refer to pages i to x and E-1 to E-40.

XL-UH240H
XL-UH240H (BK)
XL-UH2440H

BESONDERE ANMERKUNGEN
REMARQUES SPÉCIALES
NOTAS ESPECIALES
SÄRSKILDA ANMÄRKNINGAR
NOTE PARTICOLARI
BIJZONDERE OPMERKINGEN
NOTAS ESPECIAIS
SPECIAL NOTES

● **Dichiarazione di conformità**

La società SHARP ELECTRONICS EUROPE GmbH dichiara che il prodotto SHARP MICRO SISTEMI XL-UH240H/XL-UH240H (BK)/XL-UH2440H è costruito in conformità alle prescrizioni del D.M.n°548 del 28/8/95, pubblicato sulla G.U.n°301 del 28/12/95 ed in particolare è conforme a quanto indicato nell'art. 2, comma 1 dello stesso decreto.

- Bei Einstellung der ON/STAND-BY-Taste auf STAND-BY ist die Netzspannung immer noch im Gerät vorhanden. Wenn die ON/STAND-BY-Taste auf STAND-BY eingestellt wird, kann das Gerät unter Verwendung der Timer-Betriebsart oder Fernbedienung in Betrieb gesetzt werden.

Warnung:

In diesem Gerät sind keine vom Benutzer wartbaren Teile vorhanden. Niemals Abdeckungen entfernen, außer wenn Sie dafür qualifiziert sind. In diesem Gerät sind gefährliche Spannungen vorhanden. Vor Ausführung von irgendwelchen Kundendienstarbeiten oder bei längerer Nichtverwendung des Gerätes stets den Netzstecker aus der Netzsteckdose ziehen.

- Lorsque la touche ON/STAND-BY est mise en STAND-BY, l'appareil est toujours sous tension. Lorsque la touche ON/STAND-BY se trouve sur la position STAND-BY, l'appareil est prêt à fonctionner par la minuterie ou la télécommande.

Avertissement:

Cet appareil contient des pièces non réparables par l'utilisateur. Personne non qualifiée n'enlèvera jamais les couvercles. L'appareil contenant des organes portés à haute tension, débrancher l'appareil avant toute réparation ou en période de non-utilisation.

- Cuando el botón ON/STAND-BY está puesto en la posición STAND-BY, todavía hay tensión dentro del aparato. Cuando el botón ON/STAND-BY está puesto en la posición STAND-BY, el aparato puede ponerse en funcionamiento utilizando el modo del temporizador o el controlador remoto.

Advertencia:

Tenga en cuenta que dentro de este aparato no hay piezas que pueda reparar. No quite nunca las tapas a menos que se esté cualificado para hacerlo. Este aparato tiene en su interior tensiones peligrosas.

Desenchufe siempre la clavija de la red del tomacorriente antes de realizar cualquier servicio de mantenimiento y cuando no se use el aparato durante un largo período de tiempo.

- När ON/STAND-BY knappen är i läge STAND-BY, finns nätspänning i apparaten. Med ON/STAND-BY knappen i läge STAND-BY kan apparaten startas med timerfunktion eller fjärrkontrollen.

Varning:

Apparaten innehåller inga delar som kan åtgärdas av kunden. Höljet får endast öppnas av kvalificerad personal. Apparaten innehåller farliga spänningar.

Stickkontakten ska därför dras ut från nätuttaget före reparationsarbeten och bör dras ut om apparaten inte ska användas på mycket länge.

- Quando il tasto ON/STAND-BY si trova in posizione STAND-BY, all'interno dell'apparecchio c'è ancora la corrente. Se il tasto ON/STAND-BY si trova nella posizione STAND-BY, l'unità può essere accesa con il modo timer o con il telecomando.

Avvertenza:

L'apparecchio non contiene parti riparabili dall'utente. Non togliere mai i coperchi, a meno di non essere qualificati per farlo. All'interno dell'apparecchio ci sono tensioni pericolose, per cui si deve sempre staccare la spina del cavo d'alimentazione dalla presa di corrente prima di qualsiasi intervento di manutenzione e quando non si usa l'apparecchio per un lungo periodo di tempo.

- Wanneer de ON/STAND-BY toets in de STAND-BY stand staat, loopt er nog steeds stroom (netspanning) in het toestel. Wanneer de ON/STAND-BY toets in de STAND-BY stand staat, kan het toestel ingeschakeld worden via de timerfunctie of de afstandsbediening.

Waarschuwing:

Dit toestel bevat geen door de gebruiker te repareren onderdelen. Verwijder de behuizing nooit tenzij u deskundig bent op dit gebied. In het toestel loopt een gevaarlijke spanning; haal de stekker altijd uit het stopcontact alvorens onderhoud uit te voeren of wanneer het toestel voor langere tijd niet gebruikt wordt.

- Quando o botão ON/STAND-BY estiver ajustado na posição STAND-BY, a voltagem de alimentação ainda se encontra presente dentro do aparelho. Quando o botão ON/STAND-BY estiver ajustado na posição STAND-BY, o aparelho pode ser colocado em operação através do modo de programação horária ou pelo controle remoto.

Advertência:

Neste aparelho não há partes que podem ser consertadas pelo usuário. Nunca retire a tampa, a menos que você tenha qualificação para tal. Este aparelho contém voltagens perigosas. Remova sempre o cabo de alimentação da tomada antes de efetuar qualquer conserto ou quando deixar o aparelho muito tempo fora de uso.

- When the ON/STAND-BY button is set at STAND-BY position, mains voltage is still present inside the unit. When the ON/STAND-BY button is set at STAND-BY position, the unit may be brought into operation by the timer mode or remote control.

Warning:

This unit contains no user serviceable parts. Never remove covers unless qualified to do so. This unit contains dangerous voltages, always remove mains plug from the socket before any service operation and when not in use for a long period.

XL-UH240H
XL-UH240H (BK)
XL-UH2440H

- Når ON/STAND-BY-knappen er sat i STAND-BY positionen, er der stadig netspænding til stede i apparatet. Når ON/STAND-BY-knappen er sat i STAND-BY position, kan apparatet startes v.h.j.a. timer-funktionen eller fjernbetjeningen.

Advarsel:

Apparatet indeholder ingen dele, der kan repareres af brugeren selv. Fjern aldrig kabinettet med mindre De er kvalificeret hertil. Apparatet indeholder farlig strømspænding. Træk altid stikket ud af stikkontakten før der foretages reparationer, eller hvis apparatet ikke er i brug i længere tid.

PŘED SEJMUTÍM KRYTU NUTNO VYJMOUT VIDLICI ZE SÍŤOVÉ ZÁSUVKY.

PRED ZLOŽENÍM KRYTU JE NUTNÉ ODPOJIŤ PRÍSTROJ ZO SIETE.

DENNA APPARAT ÄR ANSLUTEN TILL 230 V VÄXELSTRÖM NÄR STICKPROPPEN ÄR INSKJUTEN I VÄGGUTTAGET. FÖR ATT FULLSTÄNDIGT KOPPLA IFRÅN APPARATEN, V.G. DRAG UT STICKPROPPEN.

- Audio-visuelles Material kann Urheberrechte umfassen, die ohne Genehmigung des Eigentümers dieser Urheberrechte nicht aufgenommen werden dürfen. Siehe die entsprechenden nationalen Gesetze.

- Le matériel audio-visuel peut comporter des oeuvres faisant l'objet de droits d'auteur qui ne peuvent être enregistrées sans l'autorisation du possesseur du droit d'auteur, veuillez vous référer aux réglementations nationales en vigueur.

- El material audiovisual puede consistir en trabajos que tengan derechos de autor y que no deben grabarse sin la autorización del poseedor de dichos derechos de autor. Sírvase consultar las leyes aplicables en su país.

- Audiovisuellt material kan innehålla upphovsrättsarbete som inte skall mångfaldigas utan tillstånd av copyrightinnehavaren. Se den tillämpliga lagen i ditt land.

- Il materiale audio-visivo che fosse soggetto a copyright non può essere registrato senza l'autorizzazione del possessore del copyright. Si prega di attenersi alle leggi in vigore sul territorio nazionale.

- Audio-visueel materiaal kan worden beschermd door auteursrechten, in welk geval het niet mag worden opgenomen zonder de toestemming van de auteursrechthouder. Zie voor nadere informatie de betreffende wetten in het land van gebruik.

- O material audiovisual pode consistir de trabalhos de direitos autorias que não devem ser gravados sem autorização do proprietário dos direitos. Favor consultar as leis vigentes em seu país.

- Audio-visual material may consist of copyrighted works which must not be recorded without the authority of the owner of the copyright. Please refer to relevant law in your country.

<p>● Vorsicht: Das Gerät weder Tropf- noch Spritzwasser aussetzen. Ansonsten besteht die Gefahr eines Brandes oder elektrischen Schlages. Es dürfen keine mit Flüssigkeiten gefüllten Gegenstände wie Vasen auf dem Gerät abgestellt werden.</p>
<p>● Attention: Pour éviter un incendie ou une secousse électrique, mettre l'appareil à l'abri de l'eau (éclaboussure, goutte). Ne pas poser sur l'appareil un récipient contenant du liquide.</p>
<p>● Advertencia: Para evitar incendios y descargas eléctricas, no exponga el aparato a goteo o salpicadura de líquidos. No deberán ponerse encima del aparato objetos que estén llenos de líquido, como por ejemplo un florero.</p>
<p>● Varning: Utsätt inte enheten för dropp eller stänk för att förhindra brand eller elektriska stötar. Inga vätskefyllda föremål såsom vasor får placeras på enheten.</p>
<p>● Attenzione: Per prevenire incendi o scosse elettriche, non fare gocciolare nessun liquido sull'apparecchio e non bagnarlo. Non collocarvi sopra nessun oggetto riempito d'acqua, come per esempio vasi.</p>
<p>● Waarschuwing: Stel het toestel niet bloot aan druipend of spattend water om brand en elektrische schokken te voorkomen. Met vloeistoffen gevulde voorwerpen, zoals vazen, mogen niet op het toestel geplaatst worden.</p>
<p>● Cuidado: Para evitar incendio ou choque elétrico, não exponha este aparelho a gotejamento ou salpicamento de água. Não coloque objetos com água como, por exemplo, um vaso de flores, em cima do aparelho.</p>
<p>● Warning: To prevent fire or shock hazard, do not expose this appliance to dripping or splashing. No objects filled with liquids, such as vases, shall be placed on the apparatus.</p>

<p>● Advarsel: Til at forbygge ild og stød risiko, lad være med at undsaette denne indretning for drypning eller overstaenkning. Der må ikke anbringes nogen genstande fyldt med vand, som for eksempel vaser, på dette apparat.</p>
<p>● Advarsel: For å unngå brann eller kortslutning, utsett ikke produktet for vann eller fuktighet. Gjenstander som inneholder væske, feks. en blomstervase, må ikke plasseres oppå apparatet.</p>
<p>● Varoitus: Älä vie laitetta sateeseen tai kosteisiin tiloihin. Jos laite on kostunut, anna sen kuivua ennen kuin käytät sitä verkkovirralla. Nestettä sisältäviä astioita kuten esim. kukkamaljakoita ei saa asettaa laitteen päälle.</p>

PŘÍSTROJ NEVYSTAVUJTE KAPAJÍCÍ NEBO STŘÍKAJÍCÍ VODĚ.
PŘÍSTROJ NEVYSTAVUJTE KVAPKAJÚCEJ ALEBO STRIEKAJÚCEJ VODE.
Urządzenie należy chronić przed zalaniem i wilgocią.

<p>● Dieses Produkt ist ein Laserprodukt der Klasse 1.</p>
<p>● Ce produit est classifié comme étant un LASER DE CLASSE 1.</p>
<p>● Este producto está clasificado como un PRODUCTO LÁSER DE CLASE 1.</p>
<p>● Denna produkt klassificeras som KLASS 1 LASERPRODUKT.</p>
<p>● Questo prodotto è classificato come CLASS 1 LASER PRODUCT.</p>
<p>● Dit product is geclassificeerd als een KLASSE 1 LASER PRODUCT.</p>
<p>● Este produto é classificado como PRODUTO LASER DE CLASSE 1.</p>
<p>● This product is classified as a CLASS 1 LASER PRODUCT.</p>

<p>● Dette produktet er klassifisert som et KLASSE 1 LASERPRODUKT.</p>
<p>● Dette produkt er klassificeret som et KLASSE 1 LASERPRODUKT.</p>
<p>● Tämä laite on luokiteltu LUOKAN 1 LASERLAITTEEKSI.</p>
<p>● Denna produkt klassificeras som KLASS 1 LASERAPPARAT.</p>
<p>● Tento výrobek je klasifikován jako LASEROVÝ VÝROBEK TŘÍDY 1.</p>
<p>● Tento výrobok je klasifikovaný ako LASEROVÝ VÝROBOK TRIEDY 1.</p>

● **VORSICHT**

Verwendung von Regelungen oder Einstellungen bzw. Durchführung von anderen Verfahren als die hierin angegebenen kann zum Aussetzen gefährlicher Strahlung führen.

Da der in diesem Compact Disc Player verwendete Laserstrahl für die Augen schädlich ist, ist das Gehäuse unter keinen Umständen zu zerlegen.

Wenden Sie sich für Wartungsarbeiten nur an berechtigten Fachhändler.

● **ATTENTION**

Respecter les indications données relatives à la manipulation, au réglage et au fonctionnement. En cas de non-respect, on s'exposera à une radiation dangereuse.

Éviter absolument de démonter l'appareil, qui utilise un rayon laser nuisible aux yeux. Pour toute réparation, s'adresser à une personne qualifiée.

● **PRECAUCIÓN**

El uso de los controles, ajustes o ejecución de procedimientos distintos de los especificados podría causar la exposición a radiación peligrosa.

No intente desmontar la caja ya que el haz de láser usado en este reproductor de discos compactos es perjudicial para los ojos. Para el servicio de reparación, consulte a una persona cualificada.

● **OBSERVERA**

Användning av reglage eller justeringar eller handhavande på annat sätt än som anges kan leda till farlig bestrålning.

Försök inte ta isär höljet eftersom CD-spelarens laserstråle är skadlig för ögonen. Överlåt service endast till kvalificerad personal.

● **ATTENZIONE**

L'uso dei comandi e l'effettuazione di regolazioni e procedimenti diversi da quelli specificati nel manuale possono provocare una pericolosa esposizione alle radiazioni.

Poiché il raggio laser usato in questo giradischi può danneggiare gli occhi, non smontare l'apparecchio. Per le riparazioni rivolgersi a personale specializzato.

● **LET OP**

Gebruik van regelaars, het maken van instellingen, gebruik of handelingen anders dan in deze gebruiksaanwijzing vermeld, kan gevaarlijke straling blootleggen.

De laserstraal in deze CD-speler kan de ogen beschadigen, Probeer derhalve de ombouw niet te verwijderen. Laat reparaties alleen over aan erkend onderhoudspersoneel.

● **CUIDADO**

O uso de controles, ajustes ou a execução de procedimentos além daqueles especificados aqui pode resultar em perigosa exposição à radiação.

Como os raios laser usados neste player de CD são perigosos para os olhos, não tente desmontar o aparelho. Solicite o conserto somente para pessoas especializadas.

● **CAUTION**

Use of controls, adjustments or performance of procedures other than those specified herein may result in hazardous radiation exposure.

As the laser beam used in this compact disc player is harmful to the eyes, do not attempt to disassemble the cabinet. Refer servicing to qualified personnel only.

VÝSTRAHA: VÝROBEK JE VYBAVEN LASEREM. PŘI NESPRÁVNÉ MANIPULACI S PŘÍSTROJEM V ROZPORU S TÍMTO NÁVODEM MŮŽE DOJÍT K NEBEZPEČNÉMU OZÁŘENÍ. NEOTVÍREJTE A NESNÍMEJTE PRŮTO ŽÁDNÉ KRYTY A PŘÍSTROJ NEOPRAVUJTE. OPRAVU A SERVIS SVĚŘTE ODBORNÉMU SERVISU.

VÝSTRAHA: VÝROBOK JE VYBAVENÝ LASEROM. PRI NESPRÁVNOM MANIPULOVANÍ S PŘÍSTROJOM V ROZPORE S TÍMTO NÁVODOM MÔŽE DÔJSŤ K NEBEZPEČNÉMU OŽIARENÍU. NEODKRÝVAJTE PRŮTO ŽIADNE KRYTY A PŘÍSTROJ NEOPRAVUJTE. OPRAVU A SERVIS PRENECHAJTE ODBORNÉMU SERVISU.

Eigenschaften der Laserdiode

Material: GaAlAs
Wellenlänge: 795 nm
Emissionsdauer: kontinuierlich
Laser-Ausgang: max. 0,6 mW

Caractéristiques de la diode laser

Matière: GaAlAs
Longueur d'onde: 795 nm
Durée d'émission: ininterrompue
Puissance de sortie laser maximale: 0,6 mW

Características del diodo láser

Material: GaAlAs
Longitud de onda: 795 nm
Duración de emisión : continua
Salida de láser: máx. 0,6 mW

Laserdiodens egenskaper

Material: GaAlAs
Våglängd: 795 nm
Utstrålningsvaraktighet: kontinuerlig
Lasereffekt: max. 0,6 mW

Proprietà del diodo laser

Materiale: GaAlAs
Lunghezza d'onda: 795 nm
Durata di emissione: continua
Uscita massima del laser: 0,6 mW

Laser diode specificaties

Materiaal: GaAlAs
Golflengte: 795 nm
Stralingsduur: doorlopend
Laseruitgang: max. 0,6 mW

Propriedades do diodo laser

Material: GaAlAs
Comprimento de onda: 795 nm
Duração da emissão: contínua
Saída de laser: máx. 0,6 mW

Laser Diode Properties

Material: GaAlAs
Wavelength: 795 nm
Emission Duration: continuous
Laser Output: max. 0.6 mW

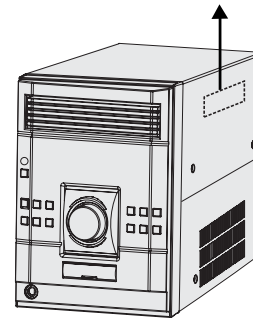
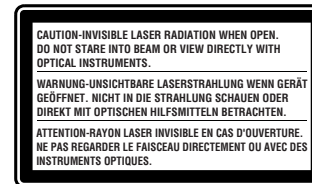

XL-UH240H
XL-UH240H (BK)
XL-UH2440H

ADVERSEL-SYNLIG OG USYNLIG LASERSTRÅLING VED ÅBNING.
SE IKKE IND I STRÅLEN-HELLER IKKE MED OPTISKE INSTRUMENTER.

VARO! AVATTAESSA OLET ALTTIINA NÄKYVÄLLE JA NÄKYMÄTTÖMÄLLE
LASERSÄTEILYLLE ÄLÄ TUIJOTA SÄTEESEEN ÄLÄKÄ KATSO SITÄ
OPTISEN LAITTEEN LÄPI.

VARNING-SYNLIG OCH OSYNLIG LASERSTRÅLNING NÄR DENNA
DEL ÄR ÖPPNAD. STIRRA EJ IN I STRÅLEN OCH BETRakta EJ
STRÅLEN GENOM OPTISKT INSTRUMENT.

**VAROITUS! LAITTEEN KÄYTTÄMINEN MUULLA KUIN TÄSSÄ
KÄYTTÖOHJEESSA MAINITULLA TAVALLA SAATTAA
ALTISTAA KÄYTTÄJÄN TURVALLISUUSLUOKAN 1
YLITTÄVÄLLE NÄKYMÄTTÖMÄLLE LASERSÄTEILYLLE.**

**VARNING - OM APPARATEN ANVÄNDS PÅ ANNAT SÄTT ÄN
I DENNA BRUKSANVISNING SPECIFICERAS. KAN
ANVÄNDAREN UTSÄTTAS FÖR OSYNLIG LASER-
STRÅLNING, SOM ÖVERSKRIDER GRÄNSEN FÖR
LASERKLASS 1.**

vi

XL-UH240H
XL-UH240H (BK)
XL-UH2440H

Entsorgungsinformationen



Achtung: Ihr Produkt trägt dieses Symbol. Es besagt, dass Elektro- und Elektronikgeräte nicht mit dem Haushaltsmüll entsorgt, sondern einem getrennten Rücknahmesystem zugeführt werden sollten.

A. Entsorgungsinformationen für Benutzer aus Privathaushalten

1. In der Europäischen Union

Achtung: Werfen Sie dieses Gerät zur Entsorgung bitte nicht in den normalen Hausmüll!

Gemäß einer neuen EU-Richtlinie, die die ordnungsgemäße Rücknahme, Behandlung und Verwertung von gebrauchten Elektro- und Elektronikgeräten vorschreibt, müssen elektrische und elektronische Altgeräte getrennt entsorgt werden.

Nach der Einführung der Richtlinie in den EU-Mitgliedstaaten können Privathaushalte ihre gebrauchten Elektro- und Elektronikgeräte nun kostenlos an ausgewiesenen Rücknahmestellen abgeben*.

In einigen Ländern* können Sie Altgeräte u.U. auch kostenlos bei Ihrem Fachhändler abgeben, wenn Sie ein vergleichbares neues Gerät kaufen.

*) Weitere Einzelheiten erhalten Sie von Ihrer Gemeindeverwaltung.

Wenn Ihre gebrauchten Elektro- und Elektronikgeräte Batterien oder Akkus enthalten, sollten diese vorher entnommen und gemäß örtlich geltenden Regelungen getrennt entsorgt werden.

Durch die ordnungsgemäße Entsorgung tragen Sie dazu bei, dass Altgeräte angemessen gesammelt, behandelt und verwendet werden. Dies verhindert mögliche schädliche Auswirkungen auf Umwelt und Gesundheit durch eine unsachgemäße Entsorgung.

2. In anderen Ländern außerhalb der EU

Bitte erkundigen Sie sich bei Ihrer Gemeindeverwaltung nach dem ordnungsgemäßen Verfahren zur Entsorgung dieses Geräts.

Für die Schweiz: Gebrauchte Elektro- und Elektronikgeräte können kostenlos beim Händler abgegeben werden, auch wenn Sie kein neues Produkt kaufen. Weitere Rücknahmesysteme finden Sie auf der Homepage von www.swico.ch oder www.sens.ch.

B. Entsorgungsinformationen für gewerbliche Nutzer

1. In der Europäischen Union

Wenn Sie dieses Produkt für gewerbliche Zwecke genutzt haben und nun entsorgen möchten:

Bitte wenden Sie sich an Ihren SHARP Fachhändler, der Sie über die Rücknahme des Produkts informieren kann. Möglicherweise müssen Sie die Kosten für die Rücknahme und Verwertung tragen. Kleine Produkte (und kleine Mengen) können möglicherweise bei Ihrer örtlichen Rücknahmestelle abgegeben werden.

Für Spanien: Bitte wenden Sie sich an das vorhandene Rücknahmesystem oder Ihre Gemeindeverwaltung, wenn Sie Fragen zur Rücknahme Ihrer Altgeräte haben.

2. In anderen Ländern außerhalb der EU

Bitte erkundigen Sie sich bei Ihrer Gemeindeverwaltung nach dem ordnungsgemäßen Verfahren zur Entsorgung dieses Geräts.

Informations sur la mise au rebut correcte



Attention : votre produit comporte ce symbole. Il signifie que les produits électriques et électroniques usagés ne doivent pas être mélangés avec les déchets ménagers généraux. Un système de collecte séparé est prévu pour ces produits.

A. Informations sur la mise au rebut à l'intention des utilisateurs privés (ménages)

1. Au sein de l'Union européenne

Attention : si vous souhaitez mettre cet appareil au rebut, ne le jetez pas dans une poubelle ordinaire!

Les appareils électriques et électroniques usagés doivent être traités séparément et conformément aux lois en vigueur en matière de traitement, de récupération et de recyclage adéquats de ces appareils.

Suite à la mise en œuvre de ces dispositions dans les Etats membres, les ménages résidant au sein de l'Union européenne peuvent désormais ramener gratuitement* leurs appareils électriques et électroniques usagés sur des sites de collecte désignés.

Dans certains pays*, votre détaillant reprendra également gratuitement votre ancien produit si vous achetez un produit neuf similaire.

*) Veuillez contacter votre administration locale pour plus de renseignements.

Si votre appareil électrique ou électronique usagé comporte des piles ou des accumulateurs, veuillez les mettre séparément et préalablement au rebut conformément à la législation locale en vigueur.

En veillant à la mise au rebut correcte de ce produit, vous contribuerez à assurer le traitement, la récupération et le recyclage nécessaires de ces déchets, et préviendrez ainsi les effets néfastes potentiels de leur mauvaise gestion sur l'environnement et la santé humaine.

2. Pays hors de l'Union européenne

Si vous souhaitez mettre ce produit au rebut, veuillez contacter votre administration locale qui vous renseignera sur la méthode d'élimination correcte de cet appareil.

Suisse : les équipements électriques ou électroniques usagés peuvent être ramenés gratuitement au détaillant, même si vous n'achetez pas un nouvel appareil. Pour obtenir la liste des autres sites de collecte, veuillez vous reporter à la page d'accueil du site www.swico.ch ou www.sens.ch.

B. Informations sur la mise au rebut à l'intention des entreprises

1. Au sein de l'Union européenne

Si ce produit est utilisé dans le cadre des activités de votre entreprise et que vous souhaitez le mettre au rebut : Veuillez contacter votre revendeur SHARP qui vous informera des conditions de reprise du produit. Les frais de reprise et de recyclage pourront vous être facturés. Les produits de petite taille (et en petites quantités) pourront être repris par vos organisations de collecte locales.

Espagne : veuillez contacter l'organisation de collecte existante ou votre administration locale pour les modalités de reprise de vos produits usagés.

2. Pays hors de l'Union européenne

Si vous souhaitez mettre ce produit au rebut, veuillez contacter votre administration locale qui vous renseignera sur la méthode d'élimination correcte de cet appareil.

Información sobre la eliminación



Atención: su producto está marcado con este símbolo. Significa que los productos eléctricos y electrónicos usados no deberían mezclarse con los residuos domésticos generales. Existe un sistema de recogida independiente para estos productos.

A. Información sobre eliminación para usuarios particulares

1. En la Unión Europea

Atención: si quiere desechar este equipo, ¡por favor no utilice el cubo de la basura habitual!

Los equipos eléctricos y electrónicos usados deberían tratarse por separado de acuerdo con la legislación que requiere un tratamiento, una recuperación y un reciclaje adecuados de los equipos eléctricos y electrónicos usados.

Tras la puesta en práctica por parte de los estados miembros, los hogares de particulares dentro de los estados de la Unión Europea pueden devolver sus equipos eléctricos y electrónicos a los centros de recogida designados sin coste alguno *.

En algunos países* es posible que también su vendedor local se lleve su viejo producto sin coste alguno si Ud. compra uno nuevo similar.

*) Por favor, póngase en contacto con su autoridad local para obtener más detalles.

Si sus equipos eléctricos o electrónicos usados tienen pilas o acumuladores, por favor deséchelos por separado con antelación según los requisitos locales.

Al desechar este producto correctamente, ayudará a asegurar que los residuos reciban el tratamiento, la recuperación y el reciclaje necesarios, previniendo de esta forma posibles efectos negativos en el medio ambiente y la salud humana que de otra forma podrían producirse debido a una manipulación de residuos inapropiada.

2. En otros países fuera de la Unión Europea

Si desea desechar este producto, por favor póngase en contacto con las autoridades locales y pregunte por el método de eliminación correcto.

Para Suiza: Los equipos eléctricos o electrónicos pueden devolverse al vendedor sin coste alguno, incluso si no compra ningún nuevo producto. Se puede encontrar una lista de otros centros de recogida en la página principal de www.swico.ch o www.sens.ch.

B. Información sobre Eliminación para empresas usuarias

1. En la Unión Europea

Si el producto se utiliza en una empresa y quiere desecharlo: Por favor póngase en contacto con su distribuidor SHARP, quien le informará sobre la recogida del producto. Puede ser que le cobren los costes de recogida y reciclaje. Puede ser que los productos de tamaño pequeño (y las cantidades pequeñas) sean recogidos por sus centros de recogida locales.

Para España: por favor, póngase en contacto con el sistema de recogida establecido o con las autoridades locales para la recogida de los productos usados.

2. En otros países fuera de la Unión Europea

Si desea desechar este producto, por favor póngase en contacto con sus autoridades locales y pregunte por el método de eliminación correcto.

Information om återvinning



OBS! Produkten är märkt med symbolen ovan. Denna symbol indikerar att elektroniska produkter inte ska kastas i det vanliga hushållsavfallet eftersom det finns ett separat avfallshanteringssystem för dem.

A. Information om återvinning av elektrisk utrustning för hushåll

1. EU-länder

OBS! Kasta inte denna produkt i soporna!

Förbrukad elektrisk utrustning måste hanteras i enlighet med gällande miljölagstiftning och återvinningsföreskrifter. I enlighet med gällande EU-regler ska hushåll ha möjlighet att lämna in elektrisk utrustning till återvinningsstationer utan kostnad.* I vissa länder* kan det även hända att man gratis kan lämna in gamla produkter till återförsäljaren när man köper en ny liknande enhet.

*) Kontakta kommunen för vidare information.

Om utrustningen innehåller batterier eller ackumulatörer ska dessa först avlägsnas och hanteras separat i enlighet med gällande miljöföreskrifter.

Genom att hantera produkten i enlighet med dessa föreskrifter kommer den att tas om hand och återvinnas på tillämpligt sätt, vilket förhindrar potentiella negativa hälso- och miljöeffekter.

2. Länder utanför EU

Kontakta de lokala myndigheterna och ta reda på gällande sorterings- och återvinningsföreskrifter om du behöver göra dig av med denna produkt.

B. Information om återvinning för företag

1. EU-länder

Gör så här om produkten ska kasseras:

Kontakta SHARPs återförsäljare för information om hur man går till väga för att lämna tillbaka produkten. Det kan hända att en avgift för transport och återvinning tillkommer. Mindre skrymmande produkter (om det rör sig om ett fåtal) kan eventuellt återlämnas till lokala återvinningsstationer.

2. Länder utanför EU

Kontakta de lokala myndigheterna och ta reda på gällande sorterings- och återvinningsföreskrifter om du behöver göra dig av med denna produkt.

XL-UH240H
XL-UH240H (BK)
XL-UH2440H

Informazioni per un corretto smaltimento



Attenzione: Il dispositivo è contrassegnato da questo simbolo, che segnala di non smaltire le apparecchiature elettriche ed elettroniche insieme ai normali rifiuti domestici. Per tali prodotti è previsto un sistema di raccolta a parte.

A. Informazioni sullo smaltimento per gli utenti (privati)

1. Nell'Unione europea

Attenzione: Per smaltire il presente dispositivo, non utilizzare il normale bidone della spazzatura! Le apparecchiature elettriche ed elettroniche usate devono essere gestite a parte e in conformità alla legislazione che richiede il trattamento, il recupero e il riciclaggio adeguato dei suddetti prodotti.

In seguito alle disposizioni attuate dagli Stati membri, i privati residenti nella UE possono conferire gratuitamente le apparecchiature elettriche ed elettroniche usate a centri di raccolta designati*.

In alcuni paesi*, anche il rivenditore locale può ritirare gratuitamente il vecchio prodotto se l'utente acquista un altro nuovo di tipologia simile.

*) Per maggiori informazioni si prega di contattare l'autorità locale competente.

Se le apparecchiature elettriche o elettroniche usate hanno batterie o accumulatori, l'utente dovrà smaltirli a parte preventivamente in conformità alle disposizioni locali. Lo smaltimento corretto del presente prodotto contribuirà a garantire che i rifiuti siano sottoposti al trattamento, al recupero e al riciclaggio necessari prevenendone il potenziale impatto negativo sull'ambiente e sulla salute umana, che potrebbe derivare da un'inadeguata gestione dei rifiuti.

2. In paesi che non fanno parte dell'UE

Se si desidera eliminare il presente prodotto, contattare le autorità locali e informarsi sul metodo di smaltimento corretto.

Per la Svizzera: Le apparecchiature elettriche o elettroniche usate possono essere restituite gratuitamente al rivenditore, anche se non si acquista un prodotto nuovo. Altri centri di raccolta sono elencati sulle homepage di www.swico.ch o di www.sens.ch.

B. Informazioni sullo smaltimento per gli utenti commerciali

1. Nell'Unione europea

Se il prodotto è impiegato a scopi commerciali, procedere come segue per eliminarlo.

Contattare il proprio rivenditore SHARP che fornirà informazioni circa il ritiro del prodotto. Potrebbero essere addebitate le spese di ritiro e riciclaggio. Prodotti piccoli (e quantitativi ridotti) potranno essere ritirati anche dai centri di raccolta locali.

Per la Spagna: Contattare il sistema di raccolta ufficiale o l'ente locale preposto al ritiro dei prodotti usati.

2. In paesi che non fanno parte dell'UE

Se si desidera eliminare il presente prodotto, contattare le autorità locali e informarsi sul metodo di smaltimento corretto.

Informazione over verantwoorde verwijdering



Let op: Uw product is van dit merkteken voorzien. Dit betekent dat afgedankte elektrische en elektronische apparatuur niet samen met het normale huisafval mogen worden weggegooid. Er bestaat een afzonderlijk inzamelingsstelsel voor deze producten.

A. Informatie over afvalverwijdering voor gebruikers (particuliere huishoudens)

1. In de Europese Unie

Let op: Deze apparatuur niet samen met het normale huisafval weggoeien!

Afgedankte elektrische en elektronische apparatuur moet gescheiden worden ingezameld conform de wetgeving inzake de verantwoorde verwerking, terugwinning en recycling van afgedankte elektrische en elektronische apparatuur.

Na de invoering van de wet door de lidstaten mogen particuliere huishoudens in de lidstaten van de Europese Unie hun afgedankte elektrische en elektronische apparatuur kosteloos* naar hiertoe aangewezen inzamelingsinrichtingen brengen*.

In sommige landen* kunt u bij de aanschaf van een nieuw apparaat het oude product kosteloos bij uw lokale distributeur inleveren.

*) Neem contact op met de plaatselijke autoriteiten voor verdere informatie.

Als uw elektrische of elektronische apparatuur batterijen of accumulators bevat dan moet u deze afzonderlijk conform de plaatselijke voorschriften weggoeien.

Door dit product op een verantwoorde manier weg te gooien, zorgt u ervoor dat het afval de juiste verwerking, terugwinning en recycling ondergaat en potentiële negatieve effecten op het milieu en de menselijke gezondheid worden voorkomen die anders zouden ontstaan door het verkeerd verwerken van het afval.

2. In andere landen buiten de Europese Unie

Als u dit product wilt weggoeien, neem dan contact op met de plaatselijke autoriteiten voor informatie omtrent de juiste verwijderingsprocedure.

Voor Zwitserland: U kunt afgedankte elektrische en elektronische apparatuur kosteloos bij de distributeur inleveren, zelfs als u geen nieuw product koopt. Aanvullende inzamelingsinrichtingen zijn vermeld op de startpagina van www.swico.ch of www.sens.ch.

B. Informatie over afvalverwijdering voor bedrijven

1. In de Europese Unie

Als u het product voor zakelijke doeleinden heeft gebruikt en als u dit wilt weggoeien:

Neem contact op met uw SHARP distributeur die u inlichtingen verschaft over de terugname van het product. Het kan zijn dat u een afvalverwijderingsbijdrage voor de terugname en recycling moet betalen. Kleine producten (en kleine hoeveelheden) kunnen door de lokale inzamelingsinrichtingen worden verwerkt.

Voor Spanje: Neem contact op met de inzamelingsinrichting of de lokale autoriteiten voor de terugname van uw afgedankte producten.

2. In andere landen buiten de Europese Unie

Als u dit product wilt weggoeien, neem dan contact op met de plaatselijke autoriteiten voor informatie omtrent de juiste verwijderingsprocedure.

Informação sobre Eliminação de Produtos



Atenção: O seu produto está identificado com este símbolo. Significa que os produtos eléctricos e electrónicos não devem ser misturados com o lixo doméstico comum. Existe um sistema de recolhas específico para estes produtos.

A. Informações sobre a Eliminação de Produtos para os Utilizadores (particulares)

1. Na União Europeia

Atenção: Se quiser eliminar este equipamento, não o deve fazer juntamente com o lixo doméstico comum! O equipamento eléctrico e electrónico deve ser tratado separadamente e ao abrigo da legislação aplicável que obriga a um tratamento, recuperação e reciclagem adequados de equipamentos eléctricos e electrónicos usados.

Após a implementação desta legislação por parte dos Estados-membros, todos os cidadãos residentes na União Europeia poderão entregar o seu equipamento eléctrico e electrónico usado em estações de recolha específicas a título gratuito*.

Em alguns países* o seu revendedor local também pode recolher o seu equipamento usado a título gratuito na compra de um novo equipamento.

*) Contacte as entidades locais para mais informações.

Se o seu equipamento eléctrico e electrónico usado funcionar a pilhas ou baterias, deverá eliminá-las em separado, conforme a legislação local, e antes de entregar o seu equipamento.

Ao eliminar este produto correctamente estará a contribuir para que o lixo seja submetido aos processos de tratamento, recuperação e reciclagem adequados. Desta forma é possível evitar os efeitos nocivos que o tratamento inadequado do lixo poderia provocar no ambiente e na saúde.

2. Em outros Países fora da UE

Se quiser eliminar este produto, contacte as entidades locais e informe-se sobre o método correcto para proceder à sua eliminação.

Na Suíça: O equipamento eléctrico e electrónico é aceite, a título gratuito, em qualquer revendedor, mesmo que não tenha adquirido um novo produto. Poderá encontrar uma lista das estações de recolha destes equipamentos na página da Web www.swicho.ch ou www.sens.ch.

B. Informações sobre a Eliminação de Produtos para Utilizadores-Empresas

1. Na União Europeia

Se o produto for usado para fins comerciais e quiser eliminá-lo:

Contacte o seu revendedor SHARP que irá informá-lo sobre a melhor forma de eliminar o produto. Poderá ter de pagar as despesas resultantes da recolha e reciclagem do produto. Alguns produtos mais pequenos (e em pequenas quantidades) poderão ser recolhidos pelas estações locais.

Na Espanha: Contacte o sistema de recolhas público ou as entidades locais para mais informações sobre a recolha de produtos usados.

2. Em outros Países fora da UE

Se quiser eliminar este produto, contacte as entidades locais e informe-se sobre o método correcto para proceder à sua eliminação.

Information on Proper Disposal



Attention: Your product is marked with this symbol. It means that used electrical and electronic products should not be mixed with general household waste. There is a separate collection system for these products.

A. Information on Disposal for Users (private households)

1. In the European Union

Attention: If you want to dispose of this equipment, please do not use the ordinary dust bin!

Used electrical and electronic equipment must be treated separately and in accordance with legislation that requires proper treatment, recovery and recycling of used electrical and electronic equipment.

Following the implementation by member states, private households within the EU states may return their used electrical and electronic equipment to designated collection facilities free of charge*. In some countries* your local retailer may also take back your old product free of charge if you purchase a similar new one.

*) Please contact your local authority for further details.

If your used electrical or electronic equipment has batteries or accumulators, please dispose of these separately beforehand according to local requirements.

By disposing of this product correctly you will help ensure that the waste undergoes the necessary treatment, recovery and recycling and thus prevent potential negative effects on the environment and human health which could otherwise arise due to inappropriate waste handling.

2. In other Countries outside the EU

If you wish to discard this product, please contact your local authorities and ask for the correct method of disposal.

For Switzerland: Used electrical or electronic equipment can be returned free of charge to the dealer, even if you don't purchase a new product. Further collection facilities are listed on the homepage of www.swico.ch or www.sens.ch.

B. Information on Disposal for Business Users

1. In the European Union

If the product is used for business purposes and you want to discard it:

Please contact your SHARP dealer who will inform you about the take-back of the product. You might be charged for the costs arising from take-back and recycling. Small products (and small amounts) might be taken back by your local collection facilities.

For Spain: Please contact the established collection system or your local authority for take-back of your used products.

2. In other Countries outside the EU

If you wish to discard of this product, please contact your local authorities and ask for the correct method of disposal.

XL-UH240H
XL-UH240H (BK)
XL-UH2440H

X

ENGLISH

Introduction

Thank you for purchasing this SHARP product. To obtain the best performance from this product, please read this manual carefully. It will guide you in operating your SHARP product.

- XL-UH240H Micro Component System consisting of XL-UH240H (main unit) and CP-UH240H (speaker system).
- XL-UH240H(BK) Micro Component System consisting of XL-UH240H(BK) (main unit) and CP-UH240H(BK) (speaker system).
- XL-UH2440H Micro Component System consisting of XL-UH2440H (main unit) and CP-UH2440H(speaker system).

Special Note

Supply of this product does not convey a license nor imply any right to distribute content created with this product in revenue-generating broadcast systems (terrestrial, satellite, cable and/or other distribution channels), revenue-generating streaming applications (via Internet, intranets and/or other networks), other revenue-generating content distribution systems (pay-audio or audio-on-demand applications and the like) or on revenue-generating physical media (compact discs, digital versatile discs, semiconductor chips, hard drives, memory cards and the like). An independent license for such use is required. For details, please visit <http://mp3licensing.com>.

MPEG Layer-3 audio coding technology licensed from Fraunhofer IIS and Thomson.

Accessories

Please confirm that the following accessories are included.

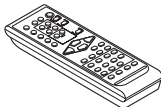
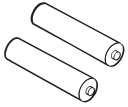
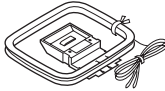
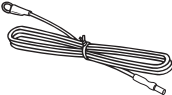
 <p>Remote control × 1</p>	 <p>"AA" size battery (UM/SUM-3, R6, HP-7 or similar) × 2</p>
 <p>AM loop aerial × 1</p>	 <p>FM aerial × 1</p>

Note:

Only the above accessories are included.

E-1

Contents

	Page
■ General Information	
Precautions	2
Controls and indicators	3 - 6
■ Preparation for Use	
System connections	7 - 9
Remote control	10
■ Basic Operation	
General control	11
Setting the clock (Remote Control only)	12
■ CD or MP3/WMA disc Playback	
Listening to a CD or MP3/WMA disc	13 - 15
Advanced CD or MP3/WMA disc playback	16 - 17
Advanced CD playback	18
MP3/WMA folder mode (only for MP3/WMA files)	19 - 20
■ USB Memory Playback	
Listening to USB mass storage device / MP3 Player ...	21 - 22
To remove USB memory device	22
Advanced USB playback	23
■ Radio	
Listening to the radio	24 - 25
■ Advanced Features	
Using the Radio Data System (RDS)	26 - 30
Timer and sleep operation (Remote Control only)	31 - 34
Enhancing your system	35 - 36
■ References	
Troubleshooting chart	36 - 38
Maintenance	38
Specifications	39 - 40

Precautions

XL-UH240H
XL-UH240H (BK)
XL-UH2440H

ENGLISH

■ General

- Please ensure that the equipment is positioned in a well-ventilated area and ensure that there is at least 10 cm (4") of free space along the sides, top and back of the equipment.

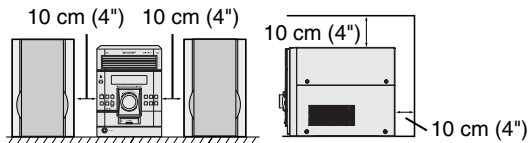

- Use the unit on a firm, level surface free from vibration.

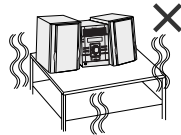

- Keep the unit away from direct sunlight, strong magnetic fields, excessive dust, humidity and electronic/electrical equipment (home computers, facsimiles, etc.) which generate electrical noise.
- Do not place anything on top of the unit.
- Do not expose the unit to moisture, to temperatures higher than 60°C (140°F) or to extremely low temperatures.
- If your system does not work properly, disconnect the AC power lead from the wall socket. Plug the AC power lead back in, and then turn on your system.
- In case of an electrical storm, unplug the unit for safety.

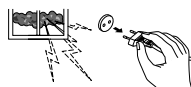

- Hold the AC power plug by the head when removing it from the wall socket, as pulling the lead can damage internal wires.
- The AC power plug is used as disconnect device and shall always remain readily operable.



- Do not remove the outer cover, as this may result in electric shock. Refer internal service to your local SHARP service facility.

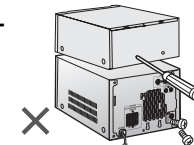

- The ventilation should not be impeded by covering the ventilation openings with items, such as newspapers, tablecloths, curtains, etc.
- No naked flame sources, such as lighted candles, should be placed on the apparatus.
- Attention should be drawn to the environmental aspects of battery disposal.
- This unit should only be used within the range of 5°C - 35°C (41°F - 95°F).
- The apparatus is designed for use in moderate climate.

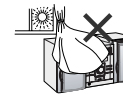

Warning:

The voltage used must be the same as that specified on this unit. Using this product with a higher voltage other than that which is specified is dangerous and may result in a fire or other type of accident causing damage. SHARP will not be held responsible for any damage resulting from use of this unit with a voltage other than that which is specified.

■ Volume control

The sound level at a given volume setting depends on speaker efficiency, location, and various other factors. It is advisable to avoid exposure to high volume levels. Do not turn the volume on to full at switch on and listen to music at moderate levels.

General Information

E-2

Controls and indicators

ENGLISH

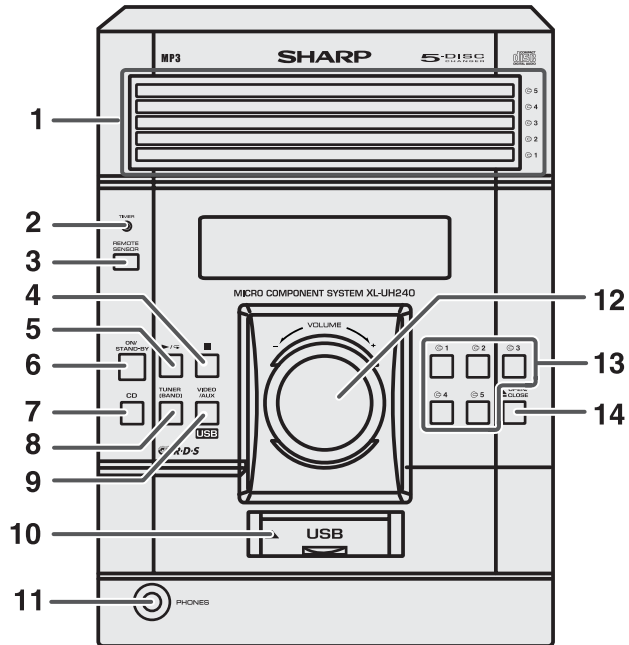

■ Front panel

	Reference page
1. Disc Trays	14
2. Timer Indicator	32
3. Remote Sensor	10
4. Disc or USB Stop Button	15
5. Disc or USB Play or Repeat Button	13, 17
6. ON/STAND-BY Button	11
7. CD Button	13
8. Tuner (Band) Button	24, 26
9. Video/Auxiliary/USB Button	21
10. USB Terminal	21
11. Headphone Socket	35
12. Volume Control	11
13. Disc Number Select Buttons	13
14. Disc Tray Open/Close Button	13

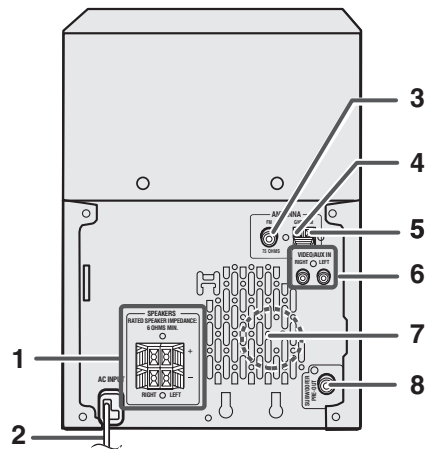
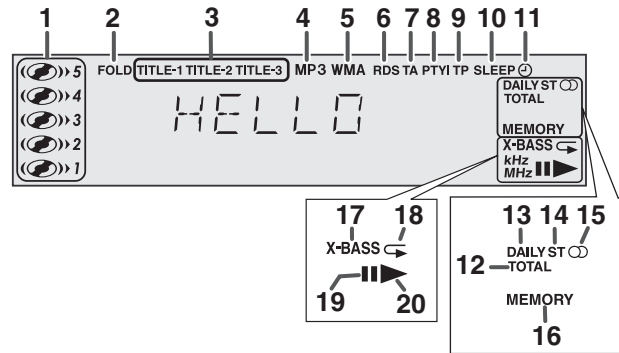

■ Display

	Reference page
1. Disc Number Indicators	14
2. MP3/WMA Folder Indicator	21
3. MP3/WMA Title Indicators	20, 22
4. MP3 Indicator	14, 21
5. WMA Indicator	14, 21
6. RDS Indicator	26
7. Traffic Announcement Indicator	26
8. Dynamic PTY Indicator	26
9. Traffic Programme Indicator	26
10. Sleep Indicator	34
11. Timer Play Indicator	32
12. MP3/WMA Total Indicator	14
13. Daily Timer Indicator	32
14. FM Stereo Mode Indicator	24
15. FM Stereo Receiving Indicator	24
16. Memory Indicator	18, 25
17. Extra Bass Indicator	11
18. Disc or USB Repeat Play Indicator	17, 23
19. Disc or USB Pause Indicator	15
20. Disc or USB Play Indicator	14, 22

■ Rear panel

	Reference page
1. Speaker Terminals	8
2. AC Power Lead	9
3. FM 75 Ohms Aerial Socket	8
4. AM Aerial Earth Terminal	8
5. AM Loop Aerial Terminal	8
6. Video/Auxiliary (Audio Signal) Input Sockets	35
7. Cooling Fan	9
8. Subwoofer Pre-output Socket	36

XL-UH240H
XL-UH240H (BK)
XL-UH2440H

Controls and indicators (continued)

ENGLISH

General Information

XL-UH240H
XL-UH240H(BK)

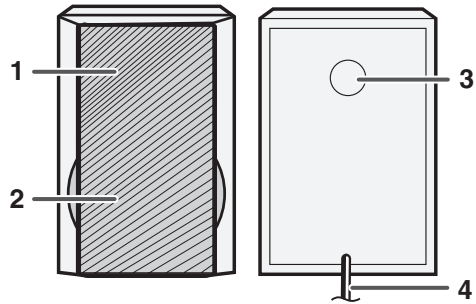

■ Speaker system

1. Tweeter
2. Woofer
3. Bass Reflex Duct
4. Speaker Wire

XL-UH2440H

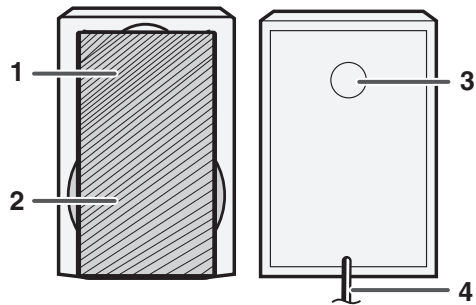

■ Speaker system

1. Tweeter
2. Woofer
3. Bass Reflex Duct
4. Speaker Wire

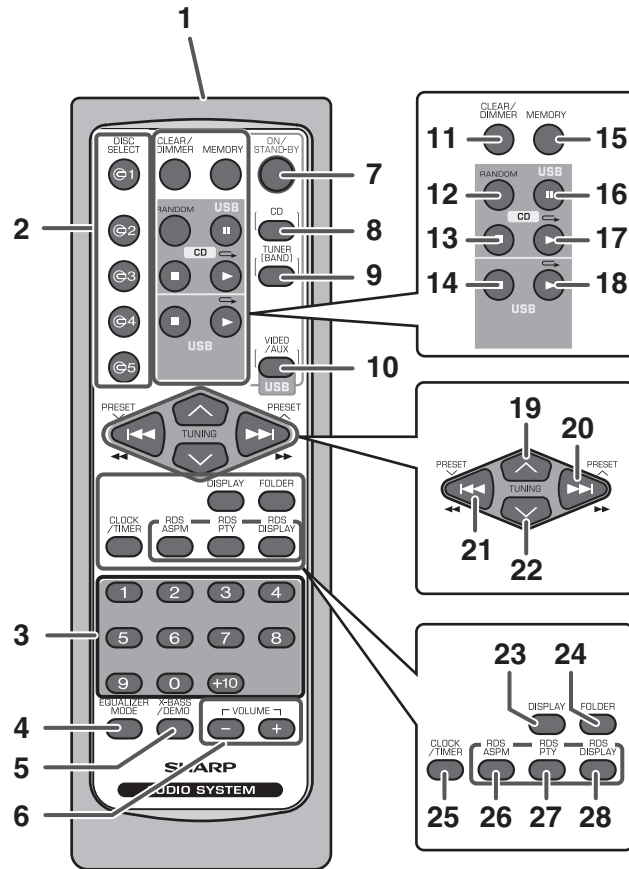

■ Remote control

	Reference page
1. Remote Control Transmitter	10
2. Disc Number Select Buttons	13
3. Disc Direct Search Buttons	16
4. Equaliser Mode Select Button	11
5. Extra Bass/Demo Button	9, 11
6. Volume Up and Down Buttons	11
7. On/Stand-by Button	11
8. CD Button	13
9. Tuner (Band) Button	24, 26
10. Video/AUX/USB Button	21
11. Clear/Dimmer Button	18
12. Disc Random Button	17
13. Disc Stop Button	15
14. USB Stop Button	21
15. Memory Button	12, 18
16. Disc/USB Pause Button	15
17. Disc Play and Repeat Button	13
18. USB Play and Repeat Button	21
19. Tuning Up Button	21, 24
20. Disc Track Up or Fast Forward, Tuner Preset Up, Time Up Button	12, 15, 21, 24, 25, 26
21. Disc Track Down or Fast Reverse, Tuner Preset Down, Time Down Button	12, 15, 21, 24, 25, 26
22. Tuning Down Button	21, 24
23. MP3/WMA Display Button	21
24. MP3/WMA Folder Button	21
25. Clock/Timer Button	12, 31, 34
26. RDS ASPM Button	26
27. RDS PTY Button	26
28. RDS Display Button	26

System connections

Make sure to unplug the AC power lead before any connections.

■ Aerial connection (see page 8)

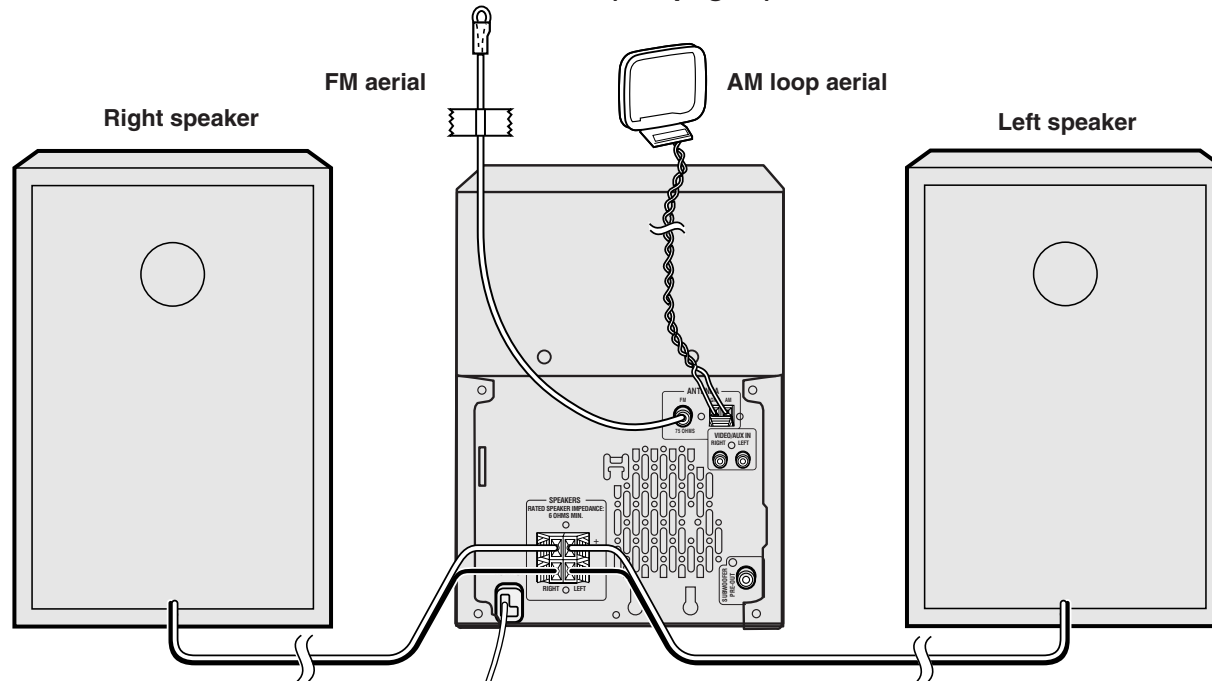

■ Speaker connection (see page 8)

Wall socket
(AC 230 V, 50 Hz)

■ AC power connection (see page 9)

■ Aerial connection

Supplied FM aerial:

Connect the FM aerial wire to the FM 75 OHMS socket and position the FM aerial wire in the direction where the strongest signal can be received.

Supplied AM loop aerial:

Connect the AM loop aerial to the AM and Earth (GND) terminals. Position the AM loop aerial for optimum reception. Place the AM loop aerial on a shelf, etc., or attach it to a stand or a wall with screws (not supplied).

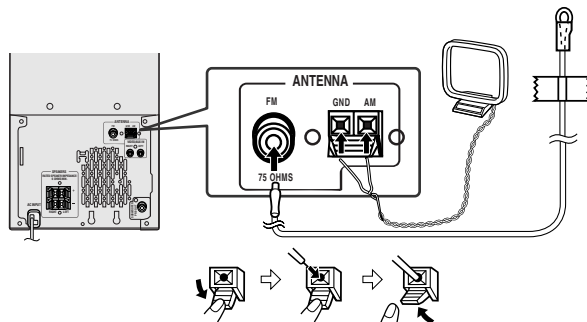

Note:

Placing the aerial on the unit or near the AC power lead may cause noise pickup. Place the aerial away from the unit for better reception.

Installing the AM loop aerial:

< Assembling >

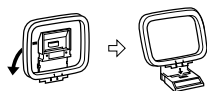

< Attaching to the wall >

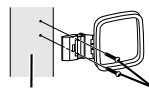

Wall Screws (not supplied)

■ Speaker connection

Connect the black wire to the minus (-) terminal, and the red wire to the plus (+) terminal.

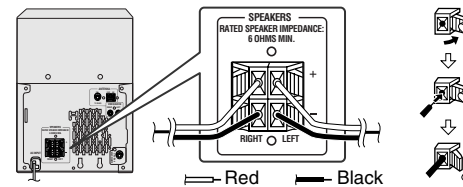

Caution:

- Use speakers with an impedance of 6 ohms or more, as lower impedance speakers can damage the unit.
- Do not mistake the right and the left channels. The right speaker is the one on the right side when you face the unit.
- **Do not let the bare speaker wires touch each other.**
- Do not allow any objects to fall into or to be placed in the bass reflex ducts.
- Do not stand or sit on the speakers. You may be injured.

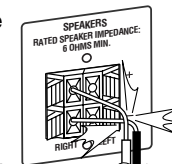

Incorrect

■ Speaker grilles are removable

Make sure nothing comes into contact with the speaker diaphragm when you remove the speaker grilles.

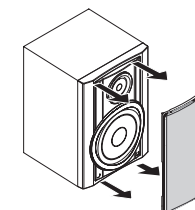

System connections (continued)

■ AC power connection

After checking all the connections have been made correctly, plug the AC power lead of this unit into the wall socket. If you plug in the unit first, the unit will enter the demonstration mode.

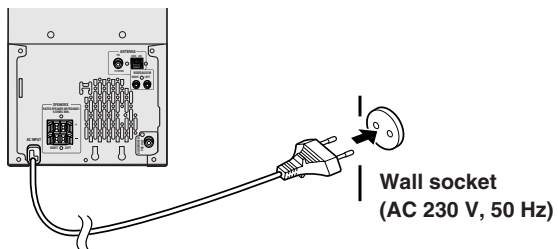

Note:

- Unplug the AC power lead from the wall socket if the unit will not be in use for a prolonged period of time.

Cooling fan:

The main unit is built with a cooling fan at the rear of the unit for improved cooling. Please do not cover the opening of the fan with any obstacles, as this will block proper ventilation.

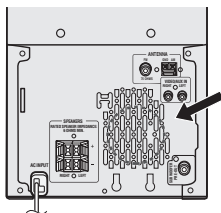

■ Demonstration mode

The first time the unit is plugged in, the unit will enter the demonstration mode. You will see words scroll.



To cancel the demonstration mode:

When the unit is in the power stand-by mode (demonstration mode), press the X-BASS/DEMO button on the remote control. The unit will enter the low power consumption mode.

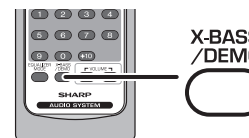

To return to the demonstration mode:

When the unit is in the power stand-by mode, press the X-BASS/DEMO button on the remote control again.

Note:

When the power is on, the X-BASS/DEMO button can be used to select the extra bass mode.

■ External FM aerial

Use an external FM aerial if you require better reception. Consult your dealer.

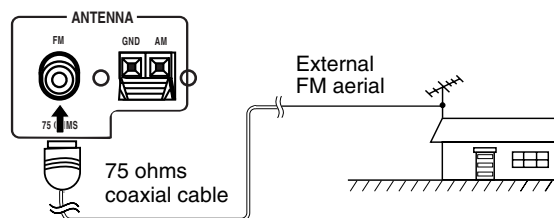

Note:

When an external FM aerial is used, disconnect the supplied FM aerial wire.

Remote control

XL-UH240H
XL-UH240H (BK)
XL-UH2440H

ENGLISH

■ Battery installation

- 1 **Open the battery cover.**
- 2 **Insert the batteries according to the direction indicated in the battery compartment.**
When inserting or removing the batteries, push them towards the ⊖ battery terminals.
- 3 **Close the cover.**

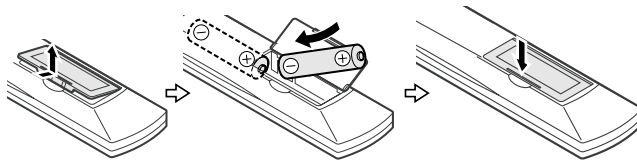

Precautions for battery use:

- Replace all old batteries with new ones at the same time.
- Do not mix old and new batteries.
- Remove the batteries if the unit will not be used for long periods of time. This will prevent potential damage due to battery leakage.

Caution:

- Do not use rechargeable batteries (nickel-cadmium battery, etc.).
- Installing the batteries incorrectly may cause the unit to malfunction.

Battery removal:

Open the battery cover and pull up the battery to take out.

Notes concerning use:

- Replace the batteries if the operating distance is reduced or if the operation becomes erratic. Purchase 2 "AA" size batteries (UM/SUM-3, R6, HP-7 or similar).
- Periodically clean the transmitter on the remote control and the sensor on the unit with a soft cloth.
- Exposing the sensor on the unit to strong light may interfere with operation. Change the lighting or the direction of the unit if this occurs.
- Keep the remote control away from moisture, heat, shock, and vibrations.

■ Test of the remote control

Check the remote control after checking all the connections (see pages 7 - 9).

Point the remote control directly at the remote sensor on the unit.

The remote control can be used within the range shown below: Press the ON/STAND-BY button. Does the power turn on? Now, you can enjoy music.

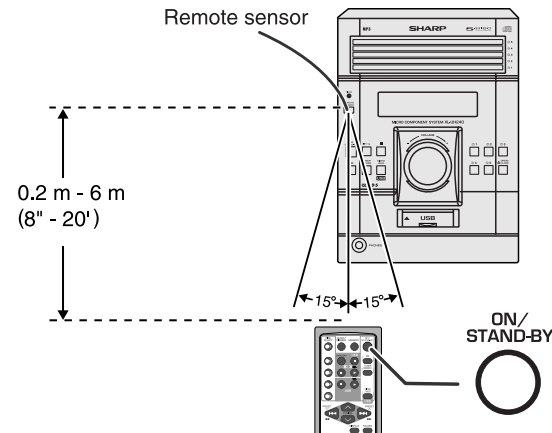

Preparation for Use

E-10

8

General control

ENGLISH

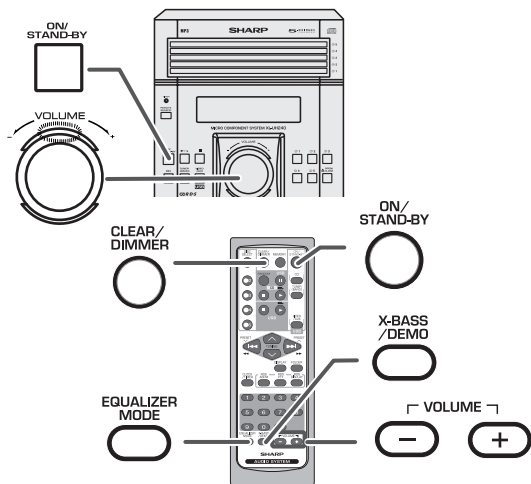

■ To turn the power on

Press the ON/STAND-BY button to turn the power on.

After use:

Press the ON/STAND-BY button to enter the power stand-by mode.

■ Illumination light control

When the power is turned on, ring around the volume control light up. To turn on/off the light, hold down the CLEAR/DIMMER button on the remote control for more than 2 seconds.

■ Volume auto fade-in

If you turn off and on the main unit with the volume set to 27 or higher, the volume starts at 16 and fades in to the last set level.

■ Volume control

Main unit operation:

When the VOLUME control is turned clockwise, the volume will increase. When it is turned anti-clockwise, the volume will decrease.

Remote control operation:

Press the VOLUME (+ or -) button to increase or decrease the volume.



■ Bass control

When the power is first turned on, the unit will enter the extra bass mode which emphasises the bass frequencies, and "X-BASS" will appear. To cancel the extra bass mode, press the X-BASS/DEMO button on the remote control.

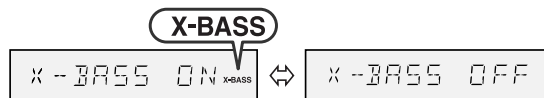

■ Equaliser

When the EQUALIZER MODE button on the remote control is pressed, the current mode setting will be displayed. To change to a different mode, press the EQUALIZER MODE button repeatedly until the desired sound mode appears.

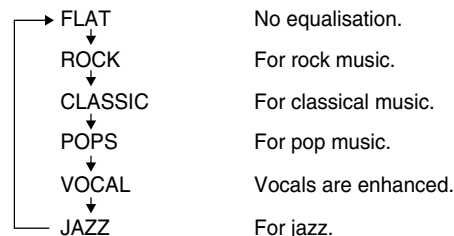

Setting the clock (Remote Control only)

XL-UH240H
XL-UH240H (BK)
XL-UH2440H

ENGLISH

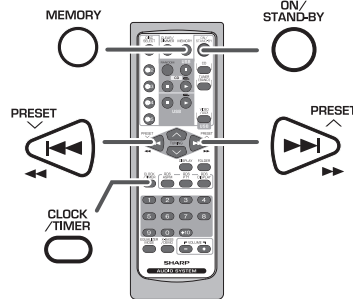

In this example, the clock is set for the 24-hour (0:00) display.

- 1 Press the ON/STAND-BY button to turn the power on.**
- 2 Press the CLOCK/TIMER button.**
- 3 Within 10 seconds, press the ◀◀ or ▶▶ button to select "CLOCK", and press the MEMORY button.**
- 4 Press the ◀◀ or ▶▶ button to select 24-hour or 12-hour display and then press the MEMORY button.**

"0:00"	→	The 24-hour display will appear. (0:00 - 23:59)
"AM 12:00"	→	The 12-hour display will appear. (AM 12:00 - PM 11:59)
"AM 0:00"	→	The 12-hour display will appear. (AM 0:00 - PM 11:59)

5 Press the ◀◀ or ▶▶ button to adjust the hour and then press the MEMORY button.



Press the ◀◀ or ▶▶ button once to advance the time by 1 hour. Hold it down to advance continuously.

6 Press the ◀◀ or ▶▶ button to adjust the minutes and then press the MEMORY button.

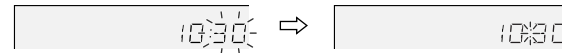

Press the ◀◀ or ▶▶ button once to advance the time by 1 minute. Hold it down to change the time in 5-minute intervals.

To confirm the time display:

[When the unit is in the stand-by mode]

Press the CLOCK/TIMER button.

The time display will appear for about 10 seconds.

[When the power is on]

Press the CLOCK/TIMER button.

Within 10 seconds, press the ◀◀ or ▶▶ button to display the time.

The time display will appear for about 10 seconds.

Note:

The "CLOCK" will appear or time will flash to confirm the time display when the AC power supply is restored after a power failure or unplugging the unit. If incorrect, readjust the clock as follows.

To readjust the clock:

Perform "Setting the clock" from step 1. If the "CLOCK" does not appear in step 3, step 4 (for selecting the 24-hour or 12-hour display) will be skipped.

To change the 24-hour or 12-hour display:

- 1 Clear all the programmed contents. [Refer to "Clearing all the memory (reset)" on page 37 for details.]
- 2 Perform "Setting the clock" from step 1.

Listening to a CD or MP3/WMA disc

This system can play back a standard CD, CD-R/RW in the CD format and CD-R/RW with MP3 or WMA files, but cannot record on them. Some audio CD-R and CD-RW discs may not be playable due to the state of the disc or the device that was used for recording.

MP3:

MP3 is a form of compression. It is an acronym which stands for MPEG Audio Layer 3.

MP3 is a type of audio code which is processed by significant compression from the original audio source with very little loss in sound quality.

- This system supports MPEG 1 Layer 3, MPEG 2 Layer 3, and VBR files.
- During VBR file playback, time counter in the display may differ from its actual playback time.
- Bitrate which is supported by MP3 is 32 ~ 320 kbps.

WMA:

WMA files are Advanced System Format files that include audio files which are compressed with Windows Media Audio codec. WMA is developed by Microsoft as an audio format file for Windows Media Player.

- "MP3" and "WMA" indicator will light up after the unit reads information on an MP3 or WMA disc.
- Bitrate which is supported by WMA is 64 ~ 160 kbps.

Auto power on function:

When you press any of the following buttons, the unit turns on.

- CD button (main unit and remote control): The unit turns on and the "CD" function is activated.
- CD ▶ / ◀ button on the remote control: The unit turns on and CD playback starts (regardless of the last function).
- ▶ / ◀ button on the main unit: The unit turns on and playback of the last function starts (CD, TUNER, VIDEO/AUX/USB).

Auto power off function:

In the stop mode of CD, MP3 or WMA operation, the main unit enters the stand-by mode after 15 minutes of inactivity.

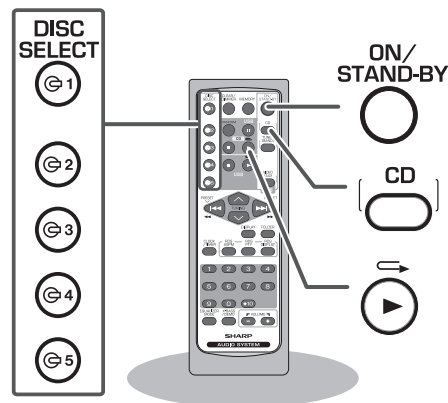
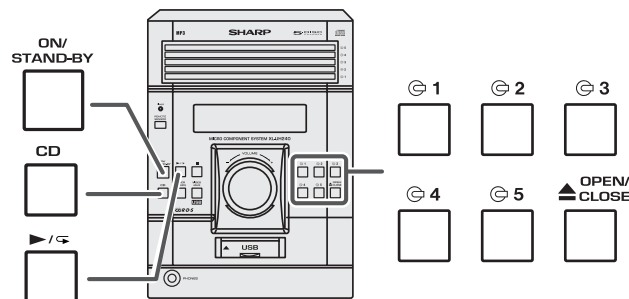

1 Press the ON/STAND-BY button to turn the power on.

2 Press the CD button.

3 Press the \odot 1 button and within 5 seconds, press the \blacktriangle OPEN/CLOSE button to open the disc tray 1.

4 Place the disc on the disc tray 1, label side up.
 Be sure to place 8 cm (3") disc in the middle of the disc trays.

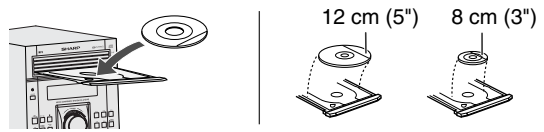

5 Press the \blacktriangle OPEN/CLOSE button to close the disc tray 1.

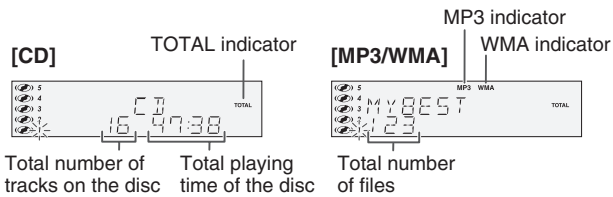

6 You can place discs on the trays 2 - 5 by following steps 3 - 5.

7 Press the \blacktriangleright / \blacktriangleleft button to start playback.



- Playback will begin from track 1 on DISC 1. After that disc finishes playing, the next disc will automatically play.
- After the last track on the fifth disc is played, the unit will stop automatically.
- When there is no disc in one of the disc trays (1 - 5), the empty tray will be skipped to the next tray with a disc.

To exchange other discs whilst playing a disc:

Press one of the \odot 1 - \odot 5 buttons for the stopped disc and within 5 seconds, press the \blacktriangle OPEN/CLOSE button and exchange discs.

To remove the discs:

In the stop mode, press the \odot 1 - \odot 5 buttons and within 5 seconds, press the \blacktriangle OPEN/CLOSE button.

To skip to a desired disc:

Press one of the \odot 1 - \odot 5 buttons and within 5 seconds, press the \blacksquare (CD \blacksquare) button.

Caution:













- Do not place two discs in a same tray.
- Do not play discs of special shapes (heart, octagon, etc). It may cause malfunctions.
- Do not push the disc tray whilst it is moving.
- If the power fails whilst the tray is open, wait until the power is restored.
- If the disc tray is stopped with force, "ER-CD20" will appear on the display for 3 seconds and the unit will not function. If this occurs, press the ON/STAND-BY button to enter the power stand-by mode and then turn the power on again.
- If TV or radio interference occurs during CD operation, move the unit away from the TV or radio.
- If a disc is damaged, dirty, or loaded upside down, the disc will be skipped.

Listening to a CD or MP3/WMA disc (continued)

ENGLISH

CD or MP3/WMA disc Playback

■ Various disc functions

Function	Main unit	Remote control	Operation
Play 			Press in the stop mode.
Stop 			Press in the playback mode.
Pause 			Press in the playback mode. Press the ► / ◀ button to resume playback from the paused point.
Track up/ Track down			Press in the playback or stop mode. If you press the button in the stop mode, press the ► / ◀ button to start the desired track.
Fast forward/ Fast reverse			Press and hold down in the playback mode. Release the button to resume playback.

Notes for CD or MP3/WMA disc:

- Track up/track down is possible only within individual discs.
- Fast forward/fast reverse is possible only within individual discs.
- When the end of the last track is reached during fast forward, "END" will appear on the display and CD operation will be paused. When the beginning of the first track is reached during fast reverse, the unit will enter the playback mode.
- Rewritable multi session discs which writing is not finished, can still be played.

Advanced CD or MP3/WMA disc playback

XL-UH240H
XL-UH240H (BK)
XL-UH2440H

■ Direct track search

By using the direct search buttons, the desired tracks on the current disc can be played.

Use the direct search buttons on the remote control to select the desired track whilst playing the selected disc.



Selected track number

- The direct search buttons allow you to select up to number 9.
- When selecting number 10 or higher, use the "+10" button.

A. For example, to choose 13

- 1 Press the "+10" button once.
- 2 Press the "1" button.
- 3 Press the "3" button.

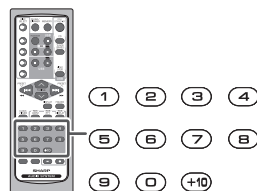

B. For example, to choose 130

- 1 Press the "+10" button twice.
- 2 Press the "1" button.
- 3 Press the "3" button.
- 4 Press the "0" button.

Notes:

- A track number higher than the number of tracks on the disc cannot be selected.
- During random play, direct search is not possible.

To stop playback:

Press the ■ (CD ■) button.

ENGLISH

CD or MP3/WMA disc Playback

E-16

8

Advanced CD or MP3/WMA disc playback (continued)

■ Repeat play

Repeat play can play one disc, all 5 discs or a programmed sequence continuously.

To repeat one disc:

Press the ► / ◀ button twice.

To repeat all tracks on up to 5 discs:

Press the ► / ◀ button three times.

To repeat desired tracks (CD only):

Perform steps 1 - 6 in "Programmed play" section on page 18 and then press the ► / ◀ button twice.



To cancel repeat play:

Press the ► / ◀ button again until "◀" will disappear.

■ Random play

The tracks on the disc(s) can be played in random order automatically.

To random play all tracks on up to 5 discs:

Press the RANDOM button on the remote control.

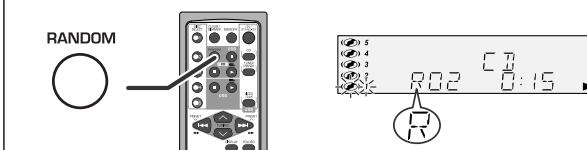

To cancel random play:

Press the ► / ◀ button.

"R" will disappear.

Notes:

- If you press the ►► button during random play, you can move to the track selected next by the random operation. On the other hand, the ◀◀ button does not allow you to move to the previous track. The beginning of the track being played will be located.
- In random play, the unit will select and play tracks automatically. (You cannot select the order of the tracks.)

Caution:

After performing repeat or random play, be sure to press the ■ (CD) button. Otherwise, the disc(s) will play continuously.





Advanced CD playback

XL-UH240H
XL-UH240H (BK)
XL-UH2440H

ENGLISH

■ Programmed play

You can choose up to 32 selections for playback in the order you like.

<p>1 Whilst in the stop mode, press the MEMORY button on the remote control to enter the programming save mode.</p>	
<p>2 Press one of the 1 - 5 buttons to select the desired disc.</p>	 <p>Selected disc number</p>
<p>3 Press the direct search buttons on the remote control to select the desired track.</p>	 <p>Selected track number</p> <p>You can also select a track by pressing the ◀ or ▶ button.</p>
<p>4 Press the MEMORY button to save the track number.</p>	
<p>5 Repeat steps 2 - 4 for other tracks. Up to 32 tracks can be programmed.</p> <p>If you make a mistake, the programmed tracks can be cleared by pressing the CLEAR/DIMMER button.</p>	
<p>6 Press the CD button.</p> <p>The total number in memory will appear.</p>	
<p>7 Press the ▶/⏪ button to start playback.</p>	

To clear the programmed selections:

Press the **CLEAR/DIMMER** button on the remote control whilst the "MEMORY" indicator is flashing. Each time the button is pressed, one track will be cleared, beginning with the last track programmed.

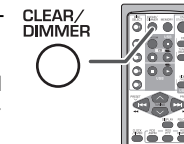

To cancel the programmed play mode:

Whilst in the stop mode and the "MEMORY" indicator is lit, press the **CLEAR/DIMMER** button on the remote control. The "MEMORY" indicator will disappear and all the programmed contents will be cleared.

Adding tracks to the programme:

If a programme has been previously stored, the "MEMORY" indicator will be displayed. Then follow steps 1 - 6 to add tracks. The new tracks will be stored after the last track of the original programme.

To check which tracks are programmed:

Whilst the unit is stopped in the programmed play mode, press the **◀** or **▶** button.

Notes:

- When a disc with programmed tracks is ejected, the programme is automatically cancelled.
- Even if you press the **ON/STAND-BY** button to enter the stand-by mode or change the function from CD to another, the programmed selections will not be cleared.
- During the programme operation, random play is not possible.

MP3/WMA folder mode (only for MP3/WMA files)

To playback MP3/WMA (Windows Media Audio) file

There are many music sites on the internet that you can download MP3/WMA (Windows Media Audio) music files. Follow the instructions from the website on how to download the music files.

You can then playback these downloaded music files by burning them to a CD-R/RW disc or by connecting a USB Memory Player device.

- Your downloaded song/files are for personal use only. Any other usage of the song without owner's permission, is against the law.

■ About folder playback order

If MP3/WMA files are recorded in several folders, a folder number will be set to each folder automatically.

These folders can be selected by the FOLDER button on the remote control. If there is no supported file formats inside the selected folder, the folder is skipped and the next folder will be selected.

Example: How to set folder number if MP3/WMA format files are recorded as below figure.

1. ROOT folder is set as folder 1.
2. As for folders inside ROOT folder (Folder A and Folder B), the folder which is recorded earlier on the disc will be set as folder 2.
3. As for folder inside Folder A (Folder C and Folder D), the folder which is recorded earlier on the disc will be set as folder 3.
4. Because there is no folder in Folder C, Folder D will be set as folder 4.
5. Folder E that is inside Folder D will be set as folder 5.
6. Folder B inside ROOT folder will be set as folder 6.

* The folder and file order information which is recorded on the disc depends on the writing software. There maybe possibilities that this unit will playback the files not according to our expected playback order.

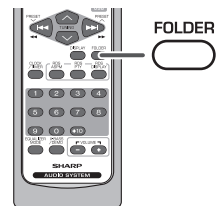

Folder mode on/off can be operated by the FOLDER button on the remote control. Files that are played when folder mode is set to the on position, may differ from those played back when folder mode is turned off.

Folder Mode Off case:

All the files starting from the selected folder or file will be played back. If file 3 inside Folder C is selected, all the files starting from file 3 will be played back.

Folder Mode On case:

All the files inside the selected folder will be played back. In case Folder D is selected, file 4, 5 and 6 will be played back. File 7 and 8 in Folder E will not be played back.

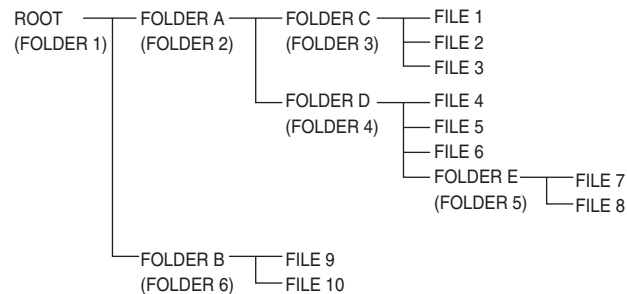

■ Procedure to playback MP3/WMA disc

To playback CD-R/RW.

1 Press the CD button, and load a MP3/WMA disc.

- After disc is loaded, the disc info will be displayed.

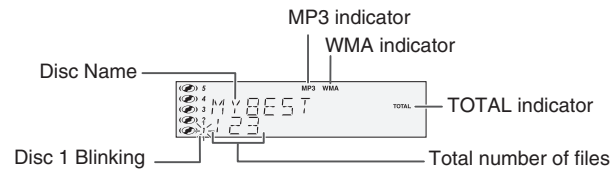

- In case folder is selected, proceed to step 2.
- In case file is selected, proceed to step 4.

2 Press the FOLDER button, and press the TUNING (∨ or ∧) button to select desired playback folder. (Folder mode on)

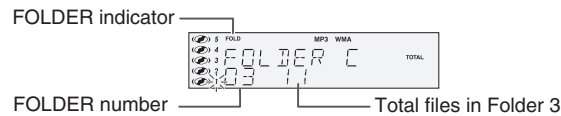

- To start playback with folder mode on, go to step 5.
- To change the playback folder, press the TUNING (∨ or ∧) to select another folder.

3 Select desired file to be played back by pressing the ◀◀ or ▶▶ button. Proceed to step 5.



4 Select desired file to be played back by pressing the ◀◀ or ▶▶ button. (Folder mode off)



5 Press the ▶ / < (CD ▶ / <) button. Playback will start and file name will be displayed.

- Title, Artist & Album name is displayed if it is recorded on the disc.
- Display content can be changed by pressing the DISPLAY button.

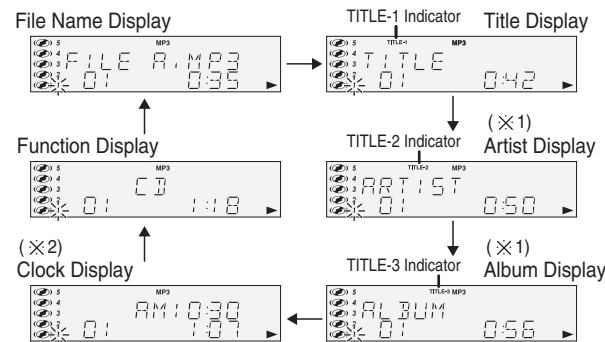

In case of playback with the folder mode on, press the TUNING (∨ or ∧) button, and the folder can be selected even though it is in playback/pause mode.

It will continue playback/pause mode in the 1st track of the selected folder.

- (× 1) MP3 ID3-Tag only support version 1.x.
- (× 2) Only appears when clock is already set.

Note:

- If "NO SUPPORT" is displayed, it means "Copyright protected WMA file" or "Not supported playback file" is selected.

Listening to USB mass storage device / MP3 Player

ENGLISH

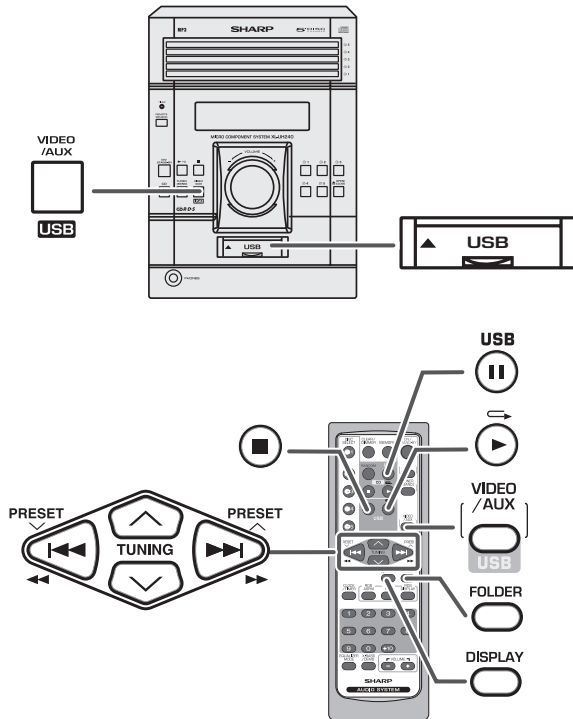

Note:
 This product is not compatible with MTP and AAC file systems.

1 Press the VIDEO/AUX/USB (USB/AUX) button, and push up the USB door. Connect the USB Memory device that has MP3/WMA format files on the unit.

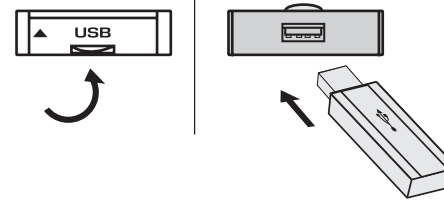

When the USB memory is connected to the main unit, the device information will be displayed.

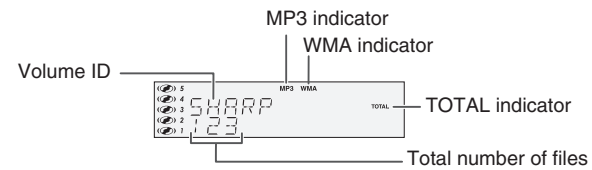

- In case folder is selected, proceed to step 2.
- In case file is selected, proceed to step 4.

2 Press the FOLDER button, and press the TUNING (∨ or ∧) button to select desired playback folder. (Folder mode on)

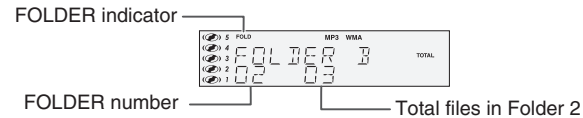

- To start playback with folder mode on, go to step 5.
- To change the playback folder, press the TUNING (∨ or ∧) button to select another folder.

3 Select desired file to be played back by pressing the ◀◀ or ▶▶ button. Proceed to step 5.

- 4 Select desired file to be played back by pressing the ◀◀ or ▶▶ button. (Folder mode off)**



- 5 Press the ▶ / ◀ (USB ▶ / ◀) button. Playback will start and the file name will be displayed.**

- Title, Artist & Album name are displayed if they are recorded in the USB memory device.
- Display content can be changed by pressing the DISPLAY button.

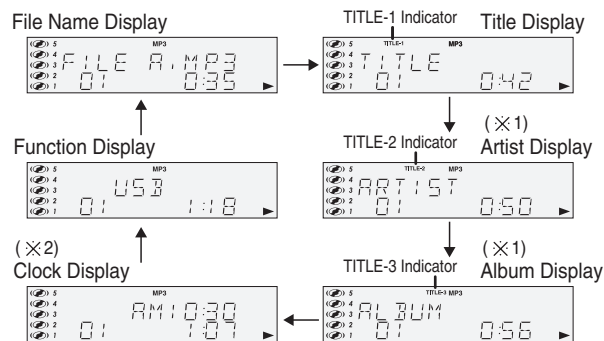

- (× 1) MP3 ID3-Tag only supports version 1.x.
- (× 2) Only appears when clock is already set.

Note:

To pause playback:
Press the CD/USB || button.

Auto power off function:

In the stop mode of USB operation, the main unit enters the stand-by mode after 15 minutes of inactivity.

To remove USB memory device

XL-UH240H
XL-UH240H (BK)
XL-UH2440H

ENGLISH

- 1 Press the USB ■ button on the remote control. Wait until "UNPLUG OK" appears on FL display.**



- 2 Disconnect USB memory device from the USB terminal.**

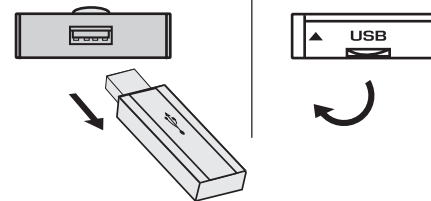

Notes:

- SHARP will not be held liable for the loss of data whilst the USB memory device is connected to the audio system.
- Files compressed in MP3 and / or WMA format can be played back when connected to the USB terminal.
- This USB memory's format supports FAT16 or FAT32.
- SHARP cannot guarantee that all USB memory devices will work on this audio system.
- This USB memory cannot be operated via USB hub.
- If "NO SUPPORT" is displayed, it means "Copyright protected WMA file" or "Not supported playback file" is selected.
- The USB terminal in this unit is not intended for a PC connection but is used for music streaming with a USB memory device.
- In case the data inside the USB memory is large, it may take a longer time for data to be read.

USB Memory Playback

Advanced USB playback

ENGLISH

Repeat play

Repeat play can play all tracks sequence continuously.

To repeat all tracks:

Press the ► / ◀ button twice.

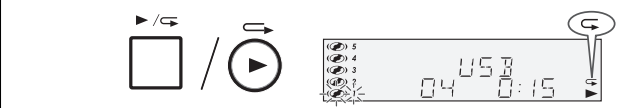

To cancel repeat play:

Press the ► / ◀ button again until "◀" will disappear.

Random play

The tracks can be played in random order automatically.

To random play all tracks:

Press the RANDOM button on the remote control.

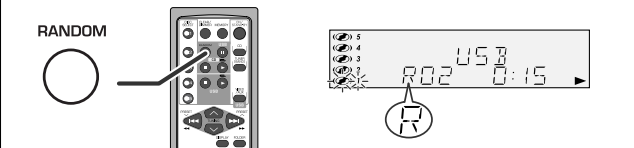

To cancel random play:

Press the ► / ◀ button.
"R" will disappear.

Notes:

- If you press the ►► button during random play, you can move to the track selected next by the random operation. On the other hand, the ◀◀ button does not allow you to move to the previous track. The beginning of the track being played will be located.
- In random play, the unit will select and play tracks automatically. (You cannot select the order of the tracks.)

Caution:

After performing repeat, be sure to press the ■ (USB ■) button. Otherwise, it will play continuously.

Note:

(⊗) When folder mode is on, the selected playmode can be used for the files in the selected folder only.

Notes:

- This unit only supports "MPEG-1 Audio Layer-3" format. (Sampling Frequency is 32, 44.1, 48kHz)
"MPEG-2 Audio Layer-3", "MPEG-2.5 Audio Layer-3" and MP1, MP2 format are not supported.
- Programme playback for USB memory is not available.
- Playback order for MP3 files may differ sometimes depending on the writing software used during file download.
- Bitrate which is supported by MP3 is 32~320 kbps, WMA is 64~160 kbps.
- For MP3/WMA files, please put ".MP3" ".WMA" extension. Files cannot be played back if there is no MP3/WMA extension.
- Playlists are not supported on this unit.
- This unit can display Folder Name or File Name up to 32 characters.
- This unit only supports MP3 ID3-Tag version 1.x.
- The display playback time may not be displayed correctly when playing back a variable bitrate file.
- Time display cannot be changed by the DISPLAY button.
- Title name and artist name can be displayed by pressing the DISPLAY button during file playback or pause mode.
- WMA meta tag also supports title, artist and album name which are recorded in WMA files.
- Copyright protected WMA files cannot be played back.

Listening to the radio

XL-UH240H
XL-UH240H (BK)
XL-UH2440H

ENGLISH

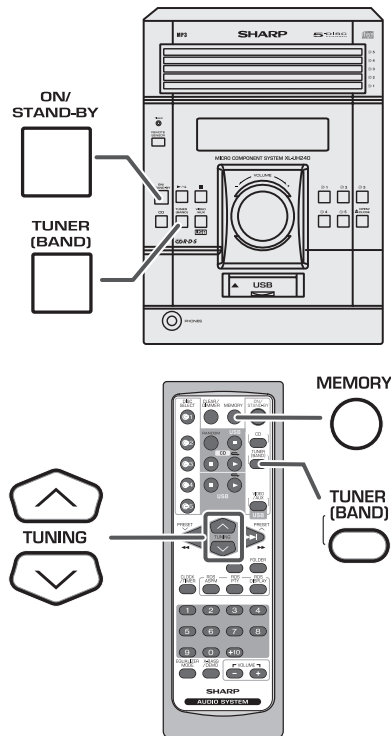

Auto power on function:

When you press any of the following buttons, the unit turns on.

- TUNER (BAND) button (main unit and remote control): The unit turns on and the "TUNER" function is activated.
- ► / ◀ button on the main unit: The unit turns on and playback of the last function starts (CD, TUNER, VIDEO/AUX/USB).

■ Tuning

- 1 Press the ON/STAND-BY button to turn the power on.
- 2 Press the TUNER (BAND) button repeatedly to select the desired frequency band (FM or AM).
- 3 Press the TUNING (∨ or ∧) button on the remote control to tune in to the desired station.

Manual tuning:

Press the TUNING (∨ or ∧) button as many times as required to tune in to the desired station.

Auto tuning:

When the TUNING (∨ or ∧) button is pressed for more than 0.5 seconds, scanning will start automatically and the tuner will stop at the first receivable broadcast station.

Notes:

- When radio interference occurs, auto scan tuning may stop automatically at that point.
- Auto scan tuning will skip weak signal stations.
- To stop the auto tuning, press the TUNING (∨ or ∧) button again.
- When an RDS (Radio Data System) station is tuned in, the frequency will be displayed first, and then the RDS indicator will light up. Finally, the station name will appear.
- Full auto tuning can be achieved for RDS stations "ASPM", see page 27.

To receive an FM stereo transmission:

Press the TUNER (BAND) button to display the "ST" indicator.

- "∞" will appear when an FM broadcast is in stereo.
- If the FM reception is weak, press the TUNER (BAND) button to extinguish the "ST" indicator. The reception changes to monaural, and the sound becomes clearer.

FM stereo mode indicator



FM stereo receiving indicator

Radio

E-24

8

Listening to the radio (continued)

ENGLISH

Radio

■ Memorising a station

You can store 40 AM and FM stations in memory and recall them at the push of a button. (Preset tuning)

1 Perform steps 1 - 3 in "Tuning" on page 24.

2 Press the MEMORY button to enter the preset tuning saving mode.

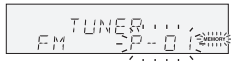

3 Within 30 seconds, press the PRESET (^ or v) button to select the preset channel number.

Store the stations in memory, in order, starting with preset channel 1.

4 Within 30 seconds, press the MEMORY button to store that station in memory.



If the "MEMORY" and preset number indicators disappear before the station is memorised, repeat the operation from step 2.

5 Repeat steps 1 - 4 to set other stations, or to change a preset station.

When a new station is stored in memory, the station previously memorised for that preset channel number will be erased.

Note:

The backup function protects the memorised stations for a few hours should there be a power failure or the AC power lead become disconnected.

■ To recall a memorised station

Press the PRESET (^ or v) button for less than 0.5 seconds to select the desired station.

■ To scan the preset stations

The stations saved in memory can be scanned automatically. (Preset memory scan)

- 1 Press the PRESET (^ or v) button for more than 0.5 seconds. The preset number will flash and the programmed stations will be tuned in sequentially, for 5 seconds each.
- 2 Press the PRESET (^ or v) button again when the desired station is located.

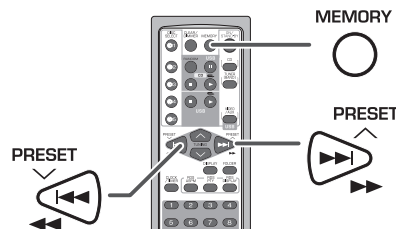

■ To erase entire preset memory

- 1 Press the ON/STAND-BY button to enter the stand-by mode.
- 2 Whilst pressing down the 1 button and the 5 button, press the TUNER (BAND) button until "TUNER CLEAR" appears.



Using the Radio Data System (RDS)

RDS is a broadcasting service which a growing number of FM stations provide. These FM stations send additional signals along with their regular programme signals. They send their station names, and information about the type of programme such as sport, music, etc.

When tuned to an RDS station, "RDS" and the station name will be displayed.

"TP" (Traffic Programme) will appear on the display when the received broadcast carries traffic information, and "TA" (Traffic Announcement) will appear whilst a traffic information is on air.

"PTYI" (Dynamic PTY Indicator) will appear whilst the Dynamic PTY station is received.

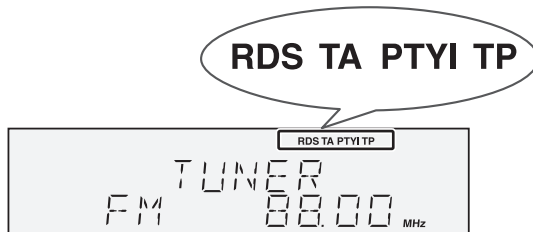

You can control the RDS by using the buttons on the remote control only.

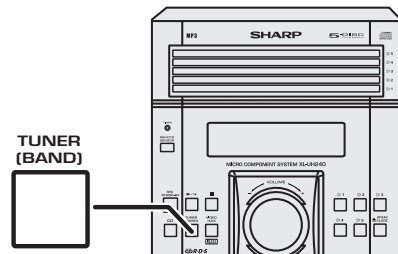

Information provided by RDS

Each time the RDS DISPLAY button is pressed, the display will switch as follows:

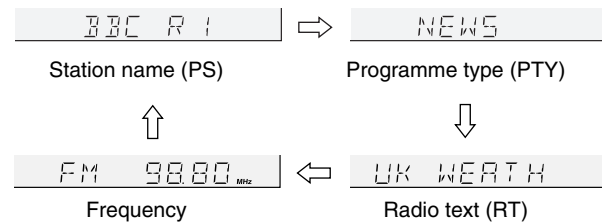
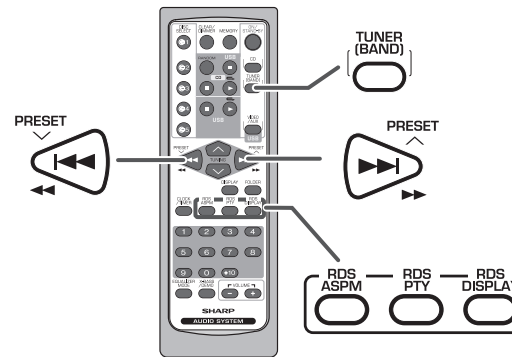

When you are tuning in to a station other than an RDS station or to an RDS station which sends weak signal, the display will change in the following order:

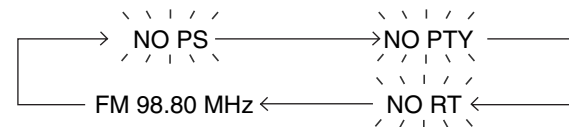

XL-UH240H
XL-UH240H (BK)
XL-UH2440H

ENGLISH



Advanced Features

E-26

Using the Radio Data System (RDS) (continued)

■ Using the Auto Station Programme Memory (ASPM)

Whilst in the ASPM operation mode, the tuner will automatically search for new RDS stations. Up to 40 stations can be stored. If you have already stored some stations in memory, the number of new stations you can store will be less.

- 1 Press the TUNER (BAND) button to select the FM band.**
- 2 Press and hold down the RDS ASPM button on the remote control for at least 3 seconds.**
 - After "ASPM" has flashed for about 4 seconds, scanning will start (87.50 - 108.00 MHz).

 - When an RDS station is found, "RDS" will appear for a short time and the station will be stored in memory.

 - After scanning, the number of stations stored in memory will be displayed for 4 seconds, and then "END" will appear for 4 seconds.

To stop the ASPM operation before it is complete:

Press the RDS ASPM button whilst it is scanning for stations. The stations which are already stored in memory will be kept there.

Notes:

- If the same station is broadcasting on different frequencies, the strongest frequency will be stored in memory.
- Any station which has the same frequency as one stored in memory will not be stored.
- If 40 stations have already been stored in memory, the scan will be aborted. If you want to redo the ASPM operation, erase the preset memory.
- If no stations have been stored in memory, "END" will appear for about 4 seconds.
- If the RDS signals are very weak, station names may not be stored in memory.

To erase all of the contents of preset memory:

- Press the ON/STAND-BY button to enter the power stand-by mode.
 - Whilst pressing down the \odot 1 button and the \odot 5 button, press the TUNER (BAND) button until "TUNER CLEAR" appears.
- After performing this operation, all of the preset memory information will be erased.

To store a station name again if the wrong name was stored in memory:

It may be impossible to store station names in memory using the ASPM function if there is lots of noise or if the signal is too weak. In this case, perform as follows.

- Press the PRESET (\wedge or \vee) button to check whether the names are correct.
 - If you find a wrong name during receiving the station, wait until the correct name will be displayed. And then press the MEMORY button.
 - Within 30 seconds, press the MEMORY button whilst the preset channel number is flashing.
- The new station name has been stored in memory correctly.

Notes:

- The same station name can be stored in different channels.
- In a certain area or during certain time periods, the station names may temporarily be different.

■ **Notes for RDS operation**

If any of the following events occur, it does not mean that the unit is faulty:

- "PS", "NO PS" and a station name appear alternately, and the unit does not operate properly.
- If a particular station is not broadcasting properly or a station is conducting tests, the RDS reception function may not work properly.
- When you receive an RDS station whose signal is too weak, information like the station name may not be displayed.
- "NO PS", "NO PTY" or "NO RT" will flash for about 5 seconds, and then the frequency will be displayed.



Notes for radio text:

- The first 10 characters of the radio text will appear for 4 seconds and then they will scroll across the display.
- If you tune in to an RDS station which is not broadcasting any radio text, "NO RT" will be displayed when you switch to the radio text position.
- Whilst radio text data is received or when the text contents change, "RT" will be displayed.

■ **To recall stations in memory**

To specify programmed types and select stations (PTY search):

You can search a station by specifying the programme type (news, sports, traffic programme, etc. ... see pages 29 - 30) from the stations in memory.

1	Press the TUNER (BAND) button to select the FM.
2	Press the RDS PTY button on the remote control.
	 <p>"SELECT" and "PTY TI" will appear alternately for about 6 seconds.</p>
3	Within 6 seconds, press the PRESET (^ or v) button to select the programme type.
	 <p>Each time the button is pressed, the programme type will appear. If the button is held down for more than 0.5 seconds, the programme type will appear continuously.</p>
4	Whilst the selected programme type is flashing (within 6 seconds), press the RDS PTY button again.
	 <p>After the selected programme type has been lit for 2 seconds, "SEARCH" will appear, and the search operation will start.</p>

Using the Radio Data System (RDS) (continued)

ENGLISH

Notes:

- If the display has stopped flashing, start again from step 2. If the unit finds a desired programme type, the corresponding channel number will flash for about 4 seconds, and then the station name will flash for 7 seconds, which will remain lit.
- If you want to listen to the same programme type of another station, press the RDS PTY button whilst the channel number or station name is flashing. The unit will look for the next station.
- If no station can be found, "NOT FOUND" will appear for 4 seconds.

If you select the traffic programme:

If you select the traffic programme (TP) in step 3, "TP" will appear. (This does not mean that you can listen to the traffic information at that time.)

When the traffic information is broadcast, "TA" will appear.

To specify station names and select stations manually:

You can select a station by specifying the name (BBC R1, BBC R2, etc.) from the stations stored in memory.

Before starting this operation, you must store one or more station names in memory.

- 1 Press the TUNER (BAND) button to select the FM band.
- 2 Press the PRESET (^ or v) button on the remote control to select a desired station.
- 3 The station name will be displayed for 6 seconds. Then the display will change.

Descriptions of the PTY (Programme Type) codes, TP (Traffic Programme) and TA (Traffic Announcement).

You can search for and receive the following PTY, TP and TA signals.

NEWS	Short accounts of facts, events and publicly expressed views, reportage and actuality.
AFFAIRS	Topical programme expanding or enlarging upon the news, generally in different presentation style or concept, including debate, or analysis.
INFO	Programmes whose purpose is to impart advice in the widest sense.
SPORT	Programme concerned with any aspect of sport.
EDUCATE	Programme intended primarily to educate, of which the formal element is fundamental.
DRAMA	All radio plays and serials.
CULTURE	Programmes concerned with any aspect of national or regional culture, including language, theatre, etc.
SCIENCE	Programmes about the natural sciences and technology.
VARIED	Used for mainly speech-based programmes usually of light-entertainment nature, not covered by other categories. Examples include: quizzes, panel games, personality interviews.
POP M	Commercial music, which would generally be considered to be of current popular appeal, often featuring in current or recent record sales charts.
ROCK M	Contemporary modern music, usually written and performed by young musicians.
EASY M	Current contemporary music considered to be "easy-listening", as opposed to Pop, Rock or Classical, or one of the specialised music styles, Jazz, Folk or Country. Music in this category is often but not always, vocal, and usually of short duration.

LIGHT M	Classical music for general, rather than specialist appreciation. Examples of music in this category are instrumental music, and vocal or choral works.
CLASSICS	Performances of major orchestral works, symphonies, chamber music, etc., and including Grand Opera.
OTHER M	Musical styles not fitting into any of the other categories. Particularly used for specialist music of which Rhythm & Blues and Reggae are examples.
WEATHER	Weather reports and forecasts and meteorological information.
FINANCE	Stock Market reports, commerce, trading, etc.
CHILDREN	For programmes targeted at a young audience, primarily for entertainment and interest, rather than where the objective is to educate.
SOCIAL	Programmes about people and things that influence them individually or in groups. Includes: sociology, history, geography, psychology and society.
RELIGION	Any aspect of beliefs and faiths, involving a God or Gods, the nature of existence and ethics.
PHONE IN	Involving members of the public expressing their views either by phone or at a public forum.
TRAVEL	Features and programmes concerned with travel to near and far destinations, package tours and travel ideas and opportunities. Not for use for announcements about problems, delays, or roadworks affecting immediate travel where TP/TA should be used.
LEISURE	Programmes concerned with recreational activities in which the listener might participate. Examples include, Gardening, Fishing, Antique collecting, Cooking, Food & Wine, etc.
JAZZ	Polyphonic, syncopated music characterised by improvisation.

COUNTRY	Songs which originate from, or continue the musical tradition of the American Southern States. Characterised by a straightforward melody and narrative story line.
NATION M	Current Popular Music of the Nation or Region in that country's language, as opposed to International 'Pop' which is usually US or UK inspired and in English.
OLDIES	Music from the so-called "golden age" of popular music.
FOLK M	Music which has its roots in the musical culture of a particular nation, usually played on acoustic instruments. The narrative or story may be based on historical events or people.
DOCUMENT	Programme concerned with factual matters, presented in an investigative style.
TEST	Broadcast when testing emergency broadcast equipment or receivers.
ALARM !	Emergency announcement made under exceptional circumstances to give warning of events causing danger of a general nature.
NONE	No programme type (receive only).
TP	Broadcasts which carry traffic announcements.
TA	Traffic announcements are being broadcast.

Timer and sleep operation (Remote Control only)

Timer playback:

The unit turns on and plays the desired source (CD, TUNER) at a preset time.

This unit has 2 types of timer: ONCE TIMER and DAILY TIMER.

Once timer: Once timer play works for one time only at a preset time.

Daily timer: Daily timer play works at the same preset time every day.

For example, set the timer as a wake-up call every morning.

Using the once timer and daily timer in combination:

For example, use the once timer to listen to a radio programme, and use the daily timer to wake up.

- 1 Set the daily timer (pages 31 - 33).
- 2 Set the once timer (pages 31 - 33).

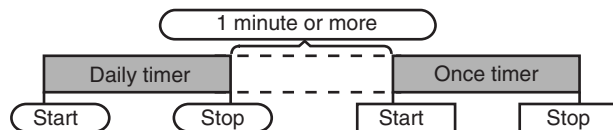

Note:

When set times for the daily timer and once timer overlap, the once timer takes priority. Allow an interval of at least 1 minute between operations.

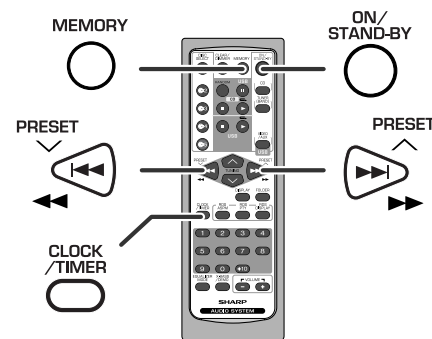

■ Timer playback

Before setting timer:

- 1 Check that the clock is set to the correct time (refer to page 12).
If it is not set, you cannot use the timer function.
- 2 For timer playback: Load discs to be played.



- 1 Press the ON/STAND-BY button to turn the power on.
- 2 Press the CLOCK/TIMER button.
- 3 Within 10 seconds, press the ◀◀ or ▶▶ button to select "ONCE" or "DAILY", and press the MEMORY button.



Set the clock to the correct time if "ONCE" or "DAILY" does not appear.

Continued to the next page

- 4** Within 10 seconds, press the **◀◀** or **▶▶** button to select "ONCE SET" or "DAILY SET", and press the **MEMORY** button.



- 5** Press the **◀◀** or **▶▶** button to adjust the hour and then press the **MEMORY** button.



The illustrations show the timer playback setting in the daily timer mode.

- 6** Press the **◀◀** or **▶▶** button to adjust the minutes and then press the **MEMORY** button.



- 7** Set the time to finish as in steps 5 and 6 above.

- 8** Switch input with the **◀◀** or **▶▶** button, and then press the **MEMORY** button.

To select the timer playback source: CD or TUNER.

- When you select the tuner, select a station by pressing the **◀◀** or **▶▶** button, and then press the **MEMORY** button.
- If a station has not been programmed, "NO PRESET" will be displayed and timer setting will be cancelled.

- 9** Adjust the volume using the **VOLUME** control, and then press the **MEMORY** button.

Do not turn the volume up too high.

- 10** Press the **ON/STAND-BY** button to enter the power stand by mode.

The "TIMER" indicator lights up and the unit is ready for timer playback.

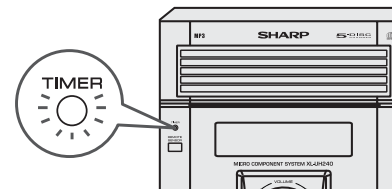

Continued to the next page

Timer and sleep operation (Remote Control only) (continued)

11 When the preset time is reached, playback will start.

The volume will increase gradually until it reaches the preset volume.

12 When the timer end time is reached, the system will enter the power stand-by mode automatically.

Once timer:

The timer will be cancelled.

Daily timer:

The timer will operate at the same time every day. It will continue until the daily timer setting is cancelled. Cancel the daily timer when it is not in use.

Note:

When performing timer playback using another unit connected to the USB terminal or AUX IN sockets, select "USB" or "AUX" in step 8. This unit will turn on or enter the power stand-by mode automatically, however, the connected unit to AUX IN sockets will not turn on or off.

Checking the timer setting in the timer stand-by mode:

- 1 Press the CLOCK/TIMER button.
- 2 Within 10 seconds, press the ◀◀ or ▶▶ button to select "ONCE" or "DAILY", and press the MEMORY button.
- 3 Within 10 seconds, press the ◀◀ or ▶▶ button to select "ONCE CALL" or "DAILY CALL", and press the MEMORY button. The unit returns to the timer stand-by mode after displaying the settings in order.

Cancelling the timer setting in the timer stand-by mode:

- 1 Press the CLOCK/TIMER button.
- 2 Within 10 seconds, press the ◀◀ or ▶▶ button to select "ONCE" or "DAILY", and press the MEMORY button.
- 3 Within 10 seconds, press the ◀◀ or ▶▶ button to select "ONCE OFF" or "DAILY OFF", and press the MEMORY button. Timer will be cancelled (the setting will not be cancelled).



Reusing the memorised timer setting:

The timer setting will be memorised once it is entered. To reuse the same setting, perform the following operations.

- 1 Turn the power on and press the CLOCK/TIMER button.
- 2 Within 10 seconds, press the ◀◀ or ▶▶ button to select "ONCE" or "DAILY", and press the MEMORY button.
- 3 Within 10 seconds, press the ◀◀ or ▶▶ button to select "ONCE ON" or "DAILY ON", and press the MEMORY button.
- 4 Press the ON/STAND-BY button to enter the power stand-by mode.

■ Sleep operation

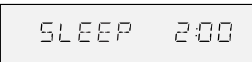
The radio, compact disc and USB can all be turned off automatically.

1	Play back the desired sound source.
2	Press the CLOCK/TIMER button.
3	Within 10 seconds, press the ◀◀ or ▶▶ button to select "SLEEP", and press the MEMORY button. 
4	Press the ◀◀ or ▶▶ button to select the time. (Maximum: 3 hours - Minimum: 1 minute) <ul style="list-style-type: none"> ● 3 hours - 5 minutes → 5-minute intervals ● 5 minutes - 1 minute → 1-minute intervals
5	Press the MEMORY button. "SLEEP" will appear. 
6	The unit will enter the power stand-by mode automatically after the preset time has elapsed. The volume will be turned down 1 minute before the sleep operation finishes.

To confirm the remaining sleep time:

- 1 Whilst "SLEEP" is indicated, press the CLOCK/TIMER button.
- 2 Within 10 seconds, press the **◀◀** or **▶▶** button to select "SLEEP X : XX".
 "X : XX" is sleep remaining time.
 - The remaining sleep time is displayed for about 10 seconds.
 - You can change the remaining sleep time whilst it is displayed by pressing the MEMORY button (steps 4 - 5).

To cancel the sleep operation:

Press the ON/STAND-BY button whilst "SLEEP" is indicated. To cancel the sleep operation without setting the unit to the stand-by mode, proceed as follows.

- 1 Whilst "SLEEP" is indicated, press the CLOCK/TIMER button.
- 2 Within 10 seconds, press the **◀◀** or **▶▶** button to select "SLEEP OFF", and press the MEMORY button.

■ To use timer and sleep operation together

Sleep and timer playback:

For example, you can fall asleep listening to the radio and wake up to CD in the next morning.

- 1 Set the sleep time (see left, steps 1 - 5).
- 2 Whilst the sleep timer is set, set the timer playback (steps 2 - 10, pages 31 - 32).

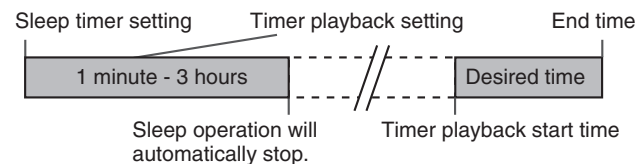

Enhancing your system

The connection lead is not included. Purchase a commercially available lead as shown below.

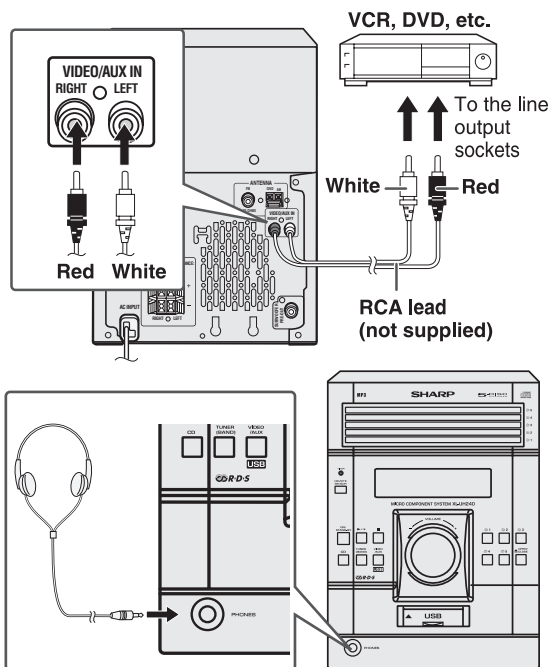

Auto power on function (USB/AUX):

When you press any of the following buttons, the unit turns on.

- VIDEO/AUX/USB button (main unit and remote control): The unit turns on and the "USB" function is activated.
- ► / < button on the main unit: The unit turns on and playback of the last function starts (CD, TUNER, VIDEO/AUX/USB).

■ Listening to the playback sounds from VCR, DVD, etc.

- 1 Use a connection lead to connect the VCR, DVD, etc. to the VIDEO/AUX IN sockets.

When using video equipment, connect the audio output to this unit and the video output to a television.

- 2 Press the ON/STAND-BY button to turn the power on.
- 3 Press the VIDEO/AUX/USB (USB/AUX) button.
- 4 Play the connected equipment.

Note:

To prevent noise interference, place the unit away from the television.

■ Headphones

- Before plugging in or unplugging the headphones, reduce the volume.
- Be sure your headphones have a 3.5 mm (1/8") diameter plug and impedance between 16 and 50 ohms. The recommended impedance is 32 ohms.
- Plugging in the headphones disconnects the speakers automatically. Adjust the volume using the VOLUME control.

■ Subwoofer connection

When a commercially available subwoofer with a built-in amplifier is connected to this unit, you can enjoy sound with emphasised bass. Connect an RCA lead from a commercially available speaker with a built-in amplifier to the SUBWOOFER PRE-OUT socket.

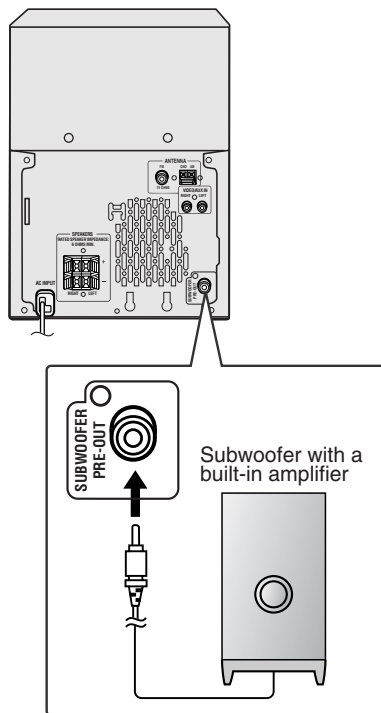

Troubleshooting chart

XL-UH240H
XL-UH240H (BK)
XL-UH2440H

ENGLISH

Many potential problems can be resolved by the owner without calling a service technician. If something is wrong with this product, check the following before calling your authorised SHARP dealer or service centre.

■ General

Symptom	Possible cause
<ul style="list-style-type: none"> ● The clock is not set to the correct time. 	<ul style="list-style-type: none"> ● Did a power failure occur? Reset the clock.
<ul style="list-style-type: none"> ● When a button is pressed, the unit does not respond. 	<ul style="list-style-type: none"> ● Set the unit to the power stand-by mode and then turn it back on. ● If the unit still malfunctions, reset it.
<ul style="list-style-type: none"> ● No sound is heard. 	<ul style="list-style-type: none"> ● Is the volume level set to "0"? ● Are the headphones connected? ● Are the speaker wires disconnected?

■ CD player

Symptom	Possible cause
<ul style="list-style-type: none"> ● Playback does not start. 	<ul style="list-style-type: none"> ● Is the disc loaded upside down?
<ul style="list-style-type: none"> ● Playback stops in the middle or is not performed properly. 	<ul style="list-style-type: none"> ● Does the disc satisfy the standards? ● Is the disc distorted or scratched?
<ul style="list-style-type: none"> ● Playback sounds are skipped, or stopped in the middle of a track. 	<ul style="list-style-type: none"> ● Is the unit located near excessive vibrations? ● Is the disc very dirty? ● Has condensation formed inside the unit?

References

E-36

8

Troubleshooting chart (continued)

ENGLISH

References

■ Remote control

Symptom	Possible cause
<ul style="list-style-type: none"> The remote control does not operate. 	<ul style="list-style-type: none"> Is the AC power lead of the unit plugged in? Is the battery polarity correct? Are the batteries dead? Is the distance or angle incorrect? Does the remote control sensor receive strong light?

■ Tuner

Symptom	Possible cause
<ul style="list-style-type: none"> The radio makes unusual noises continuously. 	<ul style="list-style-type: none"> Is the unit placed near the TV or computer? Is the FM aerial or AM loop aerial placed properly? Move the aerial away from the AC power lead if it's located nearby.

■ Condensation

Sudden temperature changes, storage or operation in an extremely humid environment may cause condensation inside the cabinet (CD pickup, etc.) or on the transmitter on the remote control. Condensation can cause the unit to malfunction. If this happens, leave the power on with no disc in the unit until normal playback is possible (about 1 hour). Wipe off any condensation on the transmitter with a soft cloth before operating the unit.

■ If trouble occurs

When this product is subjected to strong external interference (mechanical shock, excessive static electricity, abnormal supply voltage due to lightning, etc.) or if it is operated incorrectly, it may malfunction.

If such a problem occurs, do the following:

- 1 Set the unit to the stand-by mode and turn the power on again.
- 2 If the unit is not restored in the previous operation, unplug and plug in the unit, and then turn the power on.

Note:

If neither operation above restores the unit, clear all the memory by resetting it.

■ Clearing all the memory (reset)

- 1 Press the ON/STAND-BY button to enter the power stand-by mode.
- 2 Whilst pressing down the \ominus 1 button and the \ominus 5 button, press the ON/STAND-BY button until "CLEAR ALL" appears.



Caution:

This operation will erase all data stored in memory including clock, timer settings, tuner preset, and CD programme.

Maintenance

■ Before transporting the unit

Remove all CDs from the unit. Make sure there is no CD in the disc tray. Then, set the unit to the power stand-by mode. Carrying the unit with discs left inside can damage the unit.

■ Care of compact discs

Compact discs are fairly resistant to damage, however mistracking can occur due to an accumulation of dirt on the disc surface. Follow the guidelines below for maximum enjoyment from your CD collection and player.

- Do not write on either side of the disc, particularly the non-label side from which signals are read. Do not mark this surface.
- Keep your discs away from direct sunlight, heat, and excessive moisture.
- Always hold the CDs by the edges. Fingerprints, dirt, or water on the CDs can cause noise or mistracking. If a CD is dirty or does not play properly, clean it with a soft, dry cloth, wiping straight out from the centre, along the radius.

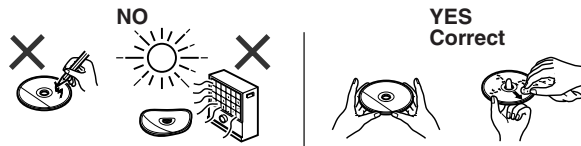

■ Cleaning the cabinet

Periodically wipe the cabinet with a soft cloth and a diluted soap solution, then with a dry cloth.

Caution:

- Do not use chemicals for cleaning (petrol, paint thinner, etc.). It may damage the cabinet finish.
- Do not apply oil to the inside of the unit. It may cause malfunctions.

Specifications

ENGLISH

As part of our policy of continuous improvement, SHARP reserves the right to make design and specification changes for product improvement without prior notice. The performance specification figures indicated are nominal values of production units. There may be some deviations from these values in individual units.

■ General

Power source	AC 230 V, 50 Hz
Power consumption	Power on: 90 W Power stand-by: 0.6 W(*)
Dimensions	Width: 175 mm (6-3/4") Height: 240 mm (9-1/2") Depth: 315 mm (12-1/5")
Weight	5.4 kg (12 lbs.)

(*) This power consumption value is obtained when the demonstration mode is cancelled in the power stand-by mode. Refer to page 9 to cancel the demonstration mode.

■ Amplifier

Output power	PMPO: 660 W MPO: 330 W (165 W + 165 W) (DIN 45 324) RMS: 160 W (80 W + 80 W) (DIN 45 324) RMS: 128 W (64 W + 64 W) (DIN 45 500)
Output terminals	Speakers: 6 ohms Headphones: 16 - 50 ohms (recommended: 32 ohms) Subwoofer pre-out (audio signal): 200 mV/10 k ohms at 70 Hz
Input terminals	Video/Auxiliary (audio signal): 500 mV/47 k ohms

■ USB

Class	Mass storage class
Support File	MP3/WMA (do not support DRM file)
Format support	FAT 16 or FAT 32
Bitrate support	MP3 (32 ~ 320 kbps) WMA (64 ~ 160 kbps)
Other	MP3 ID3 - tag only supports version 1.x USB supports version 2.0

■ CD player

Type	5-disc multi-play compact disc player
Signal readout	Non-contact, 3-beam semiconductor laser pickup
D/A converter	1-bit D/A converter
Frequency response	20 - 20,000 Hz
Dynamic range	90 dB (1 kHz)

■ Tuner

Frequency range	FM: 87.5 - 108 MHz AM: 522 - 1,620 kHz
------------------------	---

■ **Speaker**

Type	2-way type speaker system
XL-UH240H	5 cm (2") tweeter
XL-UH240H(BK)	13 cm (5-1/8") woofer
XL-UH2440H	2-way type speaker system
	2.5 cm (1") tweeter
	12 cm (4-3/4") woofer
Maximum input power	160 W
Rated input power	80 W
Impedance	6 ohms
Dimensions	Width: 185 mm (7-1/4")
XL-UH240H	Height: 260 mm (10-1/4")
XL-UH240H(BK)	Depth: 230 mm (9-1/16")
XL-UH2440H	Width: 165 mm (6-1/2")
	Height: 260 mm (10-1/4")
	Depth: 230 mm (9-1/16")
Weight	
XL-UH240H	2.8 kg (6.1 lbs.)/each
XL-UH240H(BK)	
XL-UH2440H	3 kg (6.6 lbs.)/each

SHARP

SHARP ELECTRONICS (Europe) GmbH
Sonninstraße 3, D-20097 Hamburg

SHARP CORPORATION

TINSZA200AWZZ
06E R AS ①

03/12/17 XL-UH244H_BACK.fm

↑
UP

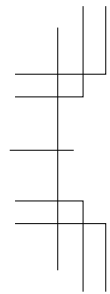

XL-UH240H/ XL-UH240H(BK)/ XL-UH2440H MICRO COMPONENT SYSTEM SHARP

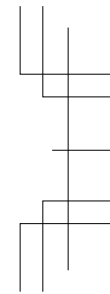
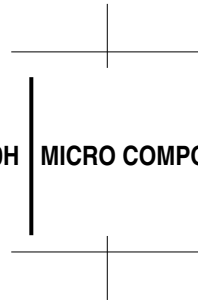

DOWN

Free Manuals Download Website

<http://myh66.com>

<http://usermanuals.us>

<http://www.somanuals.com>

<http://www.4manuals.cc>

<http://www.manual-lib.com>

<http://www.404manual.com>

<http://www.luxmanual.com>

<http://aubethermostatmanual.com>

Golf course search by state

<http://golfingnear.com>

Email search by domain

<http://emailbydomain.com>

Auto manuals search

<http://auto.somanuals.com>

TV manuals search

<http://tv.somanuals.com>