

# SHARP®

## LC-37XD1E LC-42XD1E

LCD COLOUR TELEVISION  
LCD-FARBFERNSEHGERÄT  
TÉLÉVISION COULEUR À ÉCRAN  
À CRISTAUX LIQUIDES (LCD)  
TELEVISORE A COLORI LCD  
LCD-KLEURENTELEVISIE  
TELEVISIÓN EN COLOR LCD



# AQUOS

OPERATION MANUAL  
BEDIENUNGSANLEITUNG  
MODE D'EMPLOI  
MANUALE DI ISTRUZIONI  
GEBRUIKSAANWIJZING  
MANUAL DE MANEJO



ENGLISH

DEUTSCH

FRANÇAIS



ITALIANO

NEDERLANDS

ESPAÑOL



#### **SPECIAL NOTE FOR USERS IN THE U.K.**

The mains lead of this product is fitted with a non-rewireable (moulded) plug incorporating a 13A fuse. Should the fuse need to be replaced, a BSI or ASTA approved BS 1362 fuse marked  or  and of the same rating as above, which is also indicated on the pin face of the plug, must be used.

Always refit the fuse cover after replacing the fuse. Never use the plug without the fuse cover fitted.

In the unlikely event of the socket outlet in your home not being compatible with the plug supplied, cut off the mains plug and fit an appropriate type.

#### **DANGER:**

The fuse from the cut-off plug should be removed and the cut-off plug destroyed immediately and disposed of in a safe manner.

Under no circumstances should the cut-off plug be inserted elsewhere into a 13A socket outlet, as a serious electric shock may occur.

To fit an appropriate plug to the mains lead, follow the instructions below:

#### **IMPORTANT:**

The wires in the mains lead are coloured in accordance with the following code:

**Blue: Neutral**

**Brown: Live**

As the colours of the wires in the mains lead of this product may not correspond with the coloured markings identifying the terminals in your plug, proceed as follows:

- The wire which is coloured blue must be connected to the plug terminal which is marked N or coloured black.
- The wire which is coloured brown must be connected to the plug terminal which is marked L or coloured red.

Ensure that neither the brown nor the blue wire is connected to the earth terminal in your three-pin plug.

Before replacing the plug cover make sure that:

- If the new fitted plug contains a fuse, its value is the same as that removed from the cut-off plug.
- The cord grip is clamped over the sheath of the mains lead, and not simply over the lead wires.

IF YOU HAVE ANY DOUBT, CONSULT A QUALIFIED ELECTRICIAN.

- The illustrations and on-screen displays in this operation manual are for explanation purposes and may vary slightly from the actual operations.
- The examples used throughout this manual are based on the LC-42XD1E model.

## Contents

<b>Contents</b> .....	<b>1</b>	Geometry menu.....	18
<b>Dear SHARP customer</b> .....	<b>2</b>	Picture horizontal.....	18
<b>Important Safety Precautions</b> .....	<b>2</b>	Picture vertical.....	18
<b>Trademarks</b> .....	<b>2</b>	Phase position.....	18
<b>Supplied accessories</b> .....	<b>3</b>	Other menu items.....	19
<b>Quick guide</b> .....	<b>3</b>	AV mode.....	19
Attaching the stand.....	3	Status display.....	19
Setting the TV.....	4	INPUT SOURCE.....	19
TV (Front view).....	5	Still image.....	19
TV (Rear view).....	5	OPC.....	19
Inserting the batteries.....	6	Wide modes.....	20
Using the remote control unit.....	6	Analogue teletext.....	21
Cautions regarding the remote control unit.....	6	Using analogue teletext menu.....	21
Remote control unit.....	7	Newsflash.....	21
Turning on the power.....	8	Reveal/Conceal.....	21
Standby mode.....	8	Setup.....	22
Initial auto installation (Analogue).....	8	<b>DTV menu operations</b> .....	<b>23</b>
Initial auto installation (DTV).....	8	DTV menu operation buttons.....	23
Channel selection using the station list (Analogue).....	9	DTV On-Screen Display.....	23
<b>Using external equipment</b> .....	<b>10</b>	DTV common operations.....	23
Connecting a VCR.....	10	About using the character set screen.....	24
Connecting a game console or camcorder.....	10	Language.....	24
Connecting a DVD player.....	10	Programme Setup.....	24
Connecting a decoder.....	11	Favourite.....	25
Connecting a PC.....	11	Lock.....	25
Using AV Link function.....	11	Move.....	25
<b>Menu operations</b> .....	<b>12</b>	Move To.....	25
On-Screen Display.....	12	Skip.....	25
Common operations.....	12	Select.....	26
Menu operation without a remote control.....	12	Erase.....	26
Picture menu.....	13	Label.....	26
Backlight.....	13	View.....	26
Contrast.....	13	Installation.....	26
Brightness.....	13	Auto Installation.....	26
Colour.....	13	Carrier Scan.....	26
Tint.....	13	Carrier Setup.....	27
Sharpness.....	13	System Setup.....	27
Red.....	13	OSD Setup.....	27
Green.....	13	Child Lock.....	28
Blue.....	13	Accessories.....	28
Colour temp.....	13	Software Version.....	28
Black.....	13	Software Upgrade.....	28
3D-Y/C.....	13	Common Interface.....	29
DNR (Digital Noise Reduction).....	13	Inserting a CA card.....	29
I/P setting.....	13	Supplying power to the antenna.....	29
Film mode.....	14	About EPG.....	30
truD(R).....	14	Using the EPG.....	30
Reset.....	14	Using the EPG Timer.....	30
Sound menu.....	14	Using the ESG.....	31
Treble.....	14	Using the digital programme list.....	31
Bass.....	14	Viewing a service banner.....	31
Loudness.....	14	Using the multi audio function.....	32
Auto volume.....	14	Displaying subtitles.....	32
Balance.....	14	Using the MHEG5 application (UK only).....	32
Clear voice.....	14	<b>Appendix</b> .....	<b>33</b>
Reset.....	14	Troubleshooting.....	33
Connections menu.....	15	PC compatibility chart.....	34
Decoder.....	15	RS-232C port specifications.....	34
Input select.....	15	Specifications.....	36
HDMI setup.....	15	Optional accessories.....	36
Supply voltage.....	16	End of life disposal.....	37
AV-Link (EXT 2 only).....	16		
Miscellaneous.....	16		
Setup menu.....	16		
Channels.....	16		
Child lock.....	17		
Auto format.....	17		
Language.....	17		
Factory settings.....	17		
Miscellaneous.....	18		

# Dear SHARP customer

Thank you for your purchase of the SHARP LCD colour TV product. To ensure safety and many years of trouble-free operation of your product, please read the Important Safety Precautions carefully before using this product.

## Important Safety Precautions

- Cleaning—Unplug the AC cord from the AC outlet before cleaning the product. Use a damp cloth to clean the product. Do not use liquid cleaners or aerosol cleaners.
- Water and moisture—Do not use the product near water, such as bathtub, washbasin, kitchen sink, laundry tub, swimming pool and in a wet basement.
- Do not place vases or any other water-filled containers on this product. The water may spill onto the product causing fire or electric shock.
- Stand—Do not place the product on an unstable cart, stand, tripod or table. Doing so can cause the product to fall, resulting in serious personal injuries as well as damage to the product. Use only a cart, stand, tripod, bracket or table recommended by the manufacturer or sold with the product. When mounting the product on a wall, be sure to follow the manufacturer's instructions. Use only the mounting hardware recommended by the manufacturer.
- When relocating the product placed on a cart, it must be moved with utmost care. Sudden stops, excessive force and uneven floor surface can cause the product to fall from the cart.
- Ventilation—The vents and other openings in the cabinet are designed for ventilation. Do not cover or block these vents and openings since insufficient ventilation can cause overheating and/or shorten the life of the product. Do not place the product on a bed, sofa, rug or other similar surface, since they can block ventilation openings. This product is not designed for built-in installation; do not place the product in an enclosed place such as a bookcase or rack, unless proper ventilation is provided or the manufacturer's instructions are followed.
- The LCD panel used in this product is made of glass. Therefore, it can break when the product is dropped or impact applied. If the LCD panel is broken, be careful not to be injured by broken glass.
- Heat sources—Keep the product away from heat sources such as radiators, heaters, stoves and other heat-generating products (including amplifiers).
- To prevent fire, never place any type of candle or naked flames on the top or near the TV set.
- To prevent fire or shock hazard, do not place the AC cord under the TV set or other heavy items.
- Do not display a still picture for a long time, as this could cause an afterimage to remain.
- There is power consumption always if main plug is connected.
- Servicing—Do not attempt to service the product yourself. Removing covers can expose you to high voltage and other dangerous conditions. Request a qualified person to perform servicing.

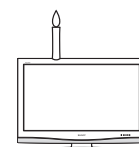

The LCD panel is a very high technology product, giving you fine picture details.

Due to the very large number of pixels, occasionally a few non-active pixels may appear on the screen as a fixed point of blue, green or red.

This is within product specifications and does not constitute a fault.

### Precautions when transporting the TV

When transporting the TV, never carry it by holding onto the speakers. Be sure to always carry the TV by two people holding it with two hands — one hand on each side of the TV.

## Trademarks

• "HDMI, the HDMI logo and High-Definition Multimedia Interface are trademarks or registered trademarks of HDMI Licensing LLC."

• truD is a registered trademark of Micronas in Germany and other countries.

• The "HD ready" Logo is a trademark of EICTA.

# Supplied accessories

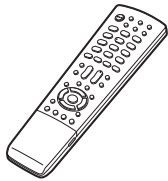
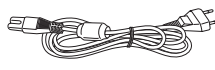
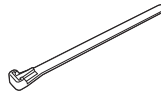
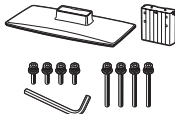
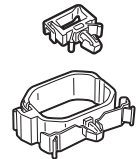
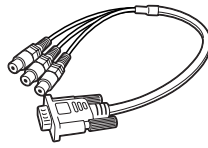
<p>Remote control unit (× 1)</p>  <p>Pages 6 and 7</p>	<p>AC cord (× 1)</p>  <p>Product shape varies in some countries. Page 4</p>	<p>Cable tie (× 1)</p>  <p>Page 4</p>	<p>Stand unit (× 1)</p>  <p>Page 3</p>	<p>Cable clamp (Small × 1, Large × 1)</p>  <p>Page 4</p>	<p>3 RCA to 15-pin D-sub adapter (× 1)</p>  <p>Page 10</p>
---	--	--	---	---	---

- “AAA” size battery (× 2).....Page 6
- Operation manual (This publication)

## Quick guide

### Attaching the stand

Before performing work spread cushioning over the base area to lay the TV on, making sure the area is completely flat. This will prevent it from being damaged.

Before attaching (or detaching) stand, unplug the AC cord from the AC INPUT terminal.

#### CAUTION

- Attach the stand in the correct direction.
- Be sure to follow the instructions. Incorrect installation of the stand may result in the TV falling over.

- 1** Confirm that there are 8 screws (4 short screws and 4 long screws) supplied with the TV.

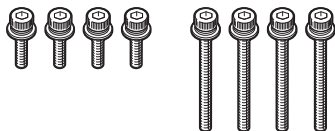

- 2** Attach the two parts of the stand unit to each other using the 4 screws and the hex key (supplied with the product) as shown.

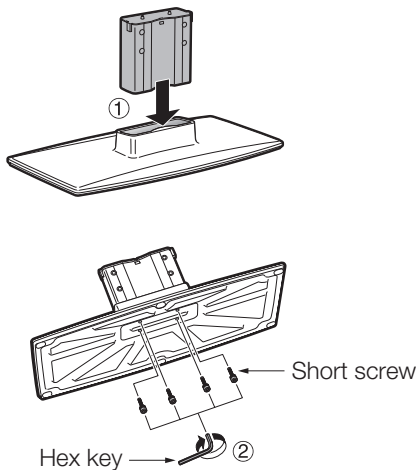

- 3** ① Insert the stand into the openings on the bottom of the TV.  
② Insert and tighten the 4 long screws into the 4 holes on the rear of the TV.

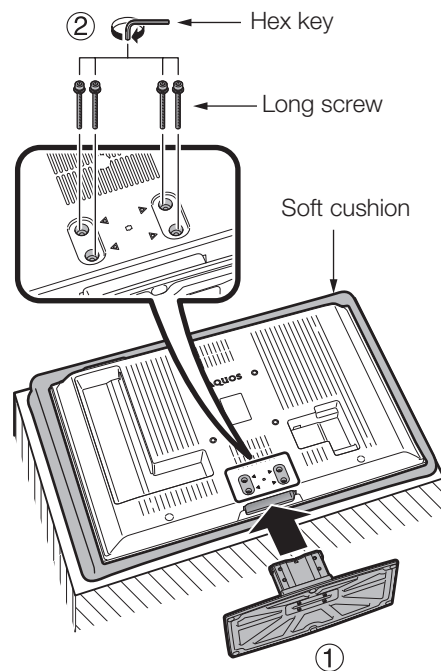

#### NOTE

- To detach the stand, perform the above steps in reverse order.

## Setting the TV

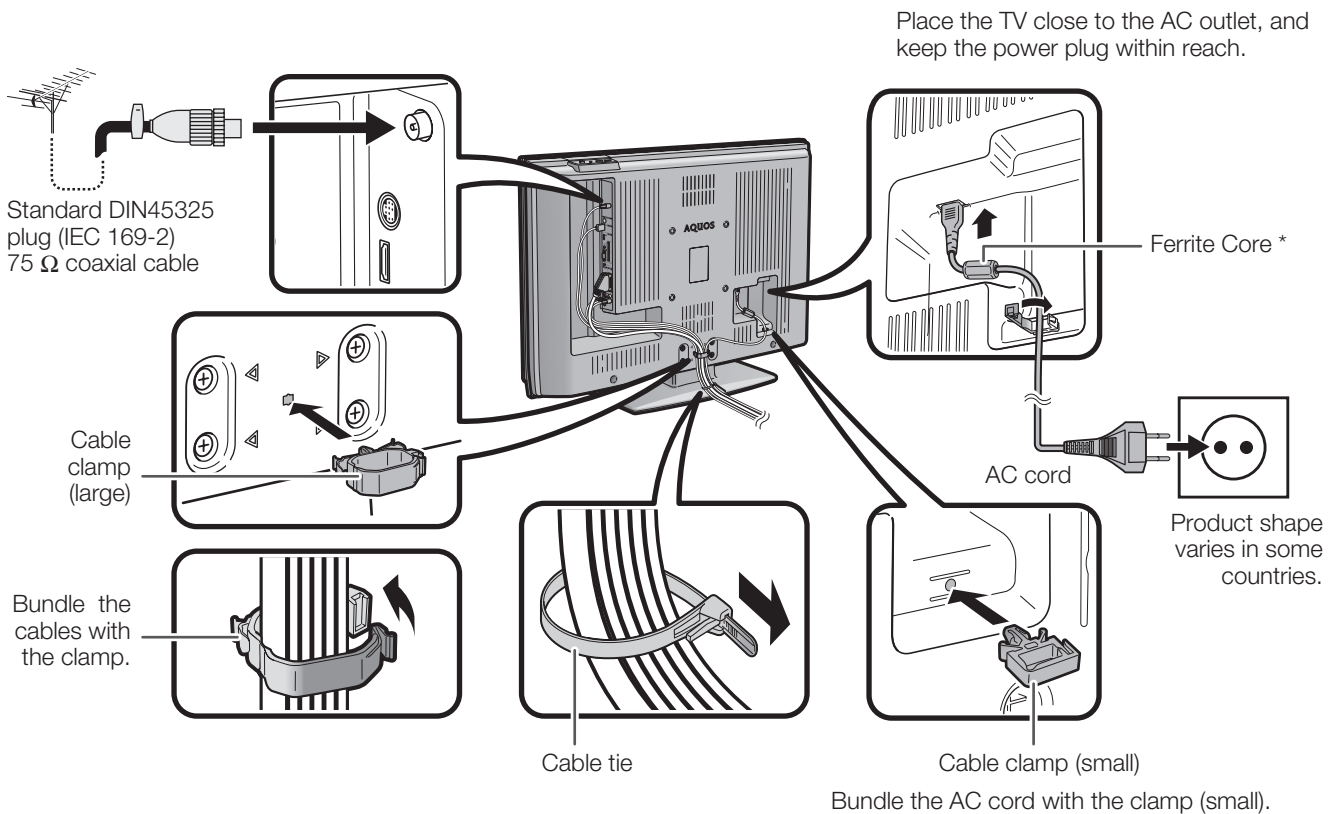

### Antenna

Connect the antenna cable from your antenna-/cable socket or the (room-/roof) antenna for antenna input terminal on the back of your TV set to receive digitally/terrestrially broadcast stations.

An indoor antenna can also be used under good reception conditions. Passive and active room antennas are offered commercially. In an active antenna its power is supplied via the antenna input terminal.

The supply voltage (5V) must be correspondingly set under "Supply voltage". (Page 16)

### \* Ferrite Core

The Ferrite Core should be permanently attached and never removed from the AC cord.

### Setting the TV on the wall

- This TV should be mounted on the wall only with the wall mount bracket available from SHARP. (See page 36.) The use of other wall mount brackets may result in an unstable installation and may cause serious injuries.
- Installing the LCD Colour TV requires special skill that should only be performed by qualified service personnel. Customers should not attempt to do the work themselves. SHARP bears no responsibility for improper mounting or mounting that results in accident or injury.
- You can ask a qualified service personnel about using an optional bracket to mount the TV to the wall.



Quick guide

**TV (Front view)**

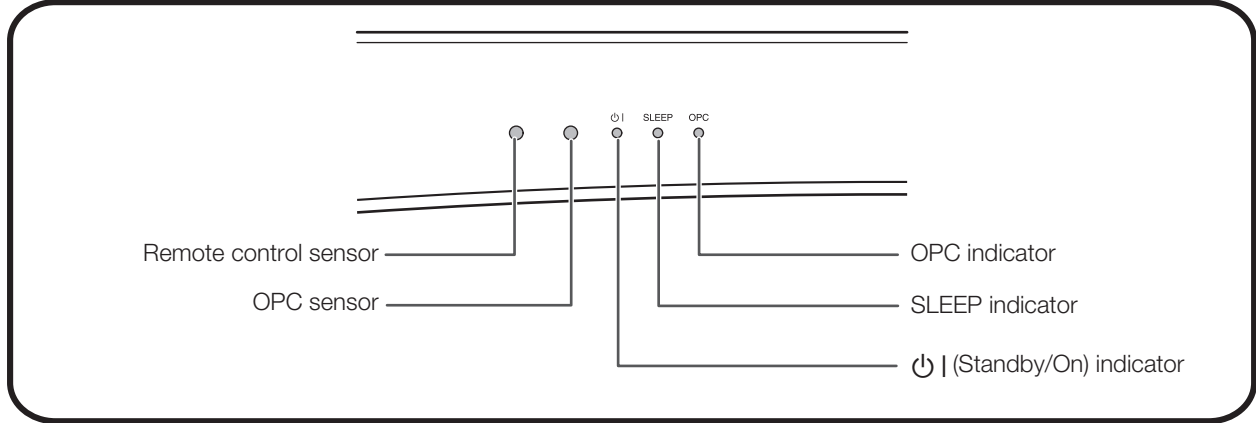
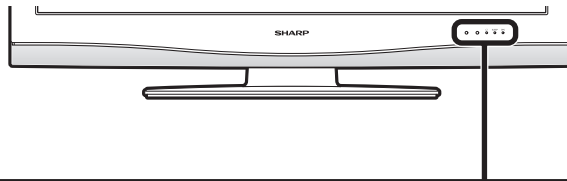

**TV (Rear view)**

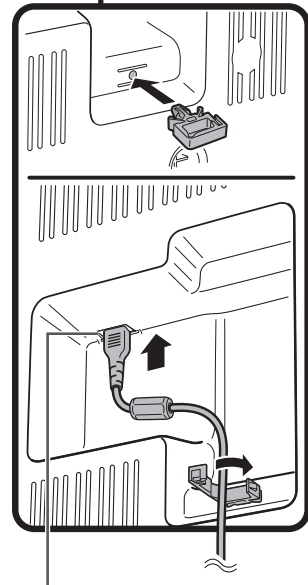
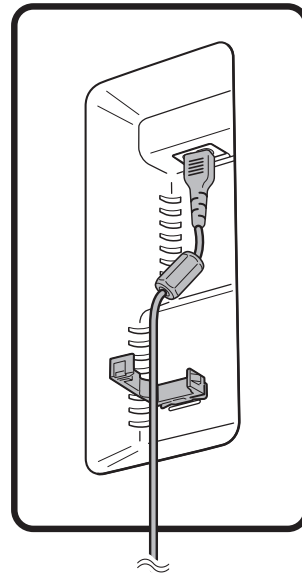
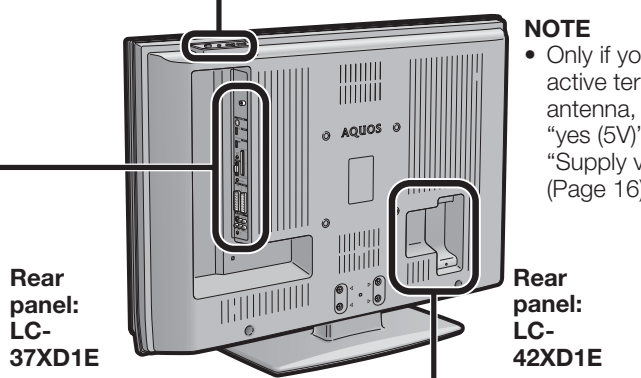
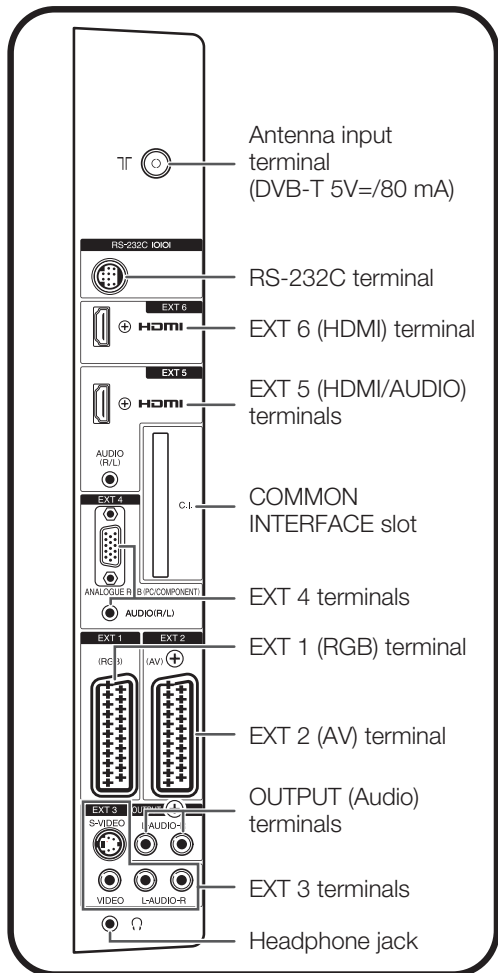
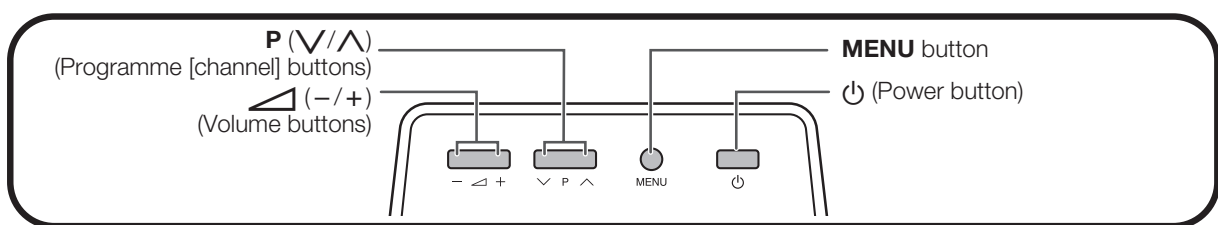

AC INPUT terminal

## Quick guide

### Inserting the batteries

Before using the TV for the first time, insert two “AAA” size batteries (supplied). When the batteries become depleted and the remote control unit fails to operate, replace the batteries with new “AAA” size batteries.

- 1 Press and slide the battery cover to open it.
- 2 Insert two supplied “AAA” size batteries.
  - Place batteries with their terminals corresponding to the (+) and (–) indications in the battery compartment.
- 3 Close the battery cover.

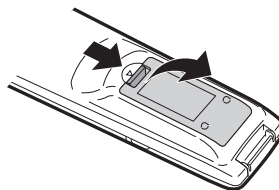

#### CAUTION

Improper use of batteries can result in chemical leakage or explosion. Be sure to follow the instructions below.

- Do not mix batteries of different types. Different types of batteries have different characteristics.
- Do not mix old and new batteries. Mixing old and new batteries can shorten the life of new batteries or cause chemical leakage in old batteries.
- Remove batteries as soon as they have worn out. Chemicals that leak from batteries can cause a rash. If you find any chemical leakage, wipe thoroughly with a cloth.
- The batteries supplied with this product may have a shorter life expectancy due to storage conditions.
- If you will not be using the remote control unit for an extended period of time, remove the batteries from it.

### Using the remote control unit

Use the remote control unit by pointing it towards the remote control sensor. Objects between the remote control unit and sensor may prevent proper operation.

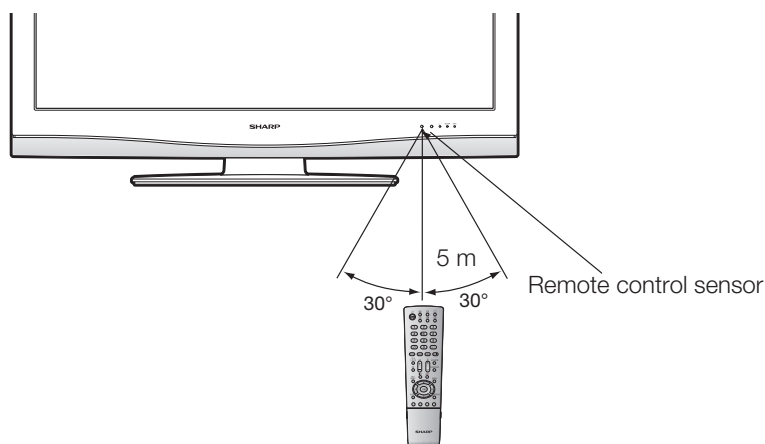

### Cautions regarding the remote control unit

- Do not expose the remote control unit to shock. In addition, do not expose the remote control unit to liquids, and do not place in an area with high humidity.
- Do not install or place the remote control unit under direct sunlight. The heat may cause deformation of the unit.
- The remote control unit may not work properly if the remote control sensor of the TV is under direct sunlight or strong lighting. In such case, change the angle of the lighting or TV, or operate the remote control unit closer to the remote control sensor.

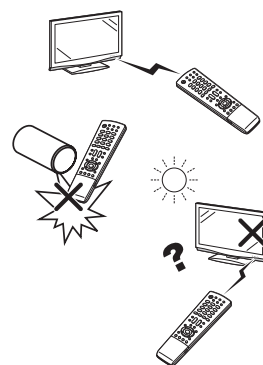



Remote control unit

- 1 **(Standby/On)**  
(Page 8)
- 2 **(Teletext)**  
TV: Display the analogue teletext. (Page 21)  
DTV: Select DTV data broadcasting and TELETEXT. (Page 32)
- 3 **(Reveal hidden Teletext)**  
(Pages 21 and 22)
- 4 **(Subtitle for Teletext)**  
TV/External: Subtitle on/off. (Page 22)  
DTV: Display the subtitle selection screen. (Page 32)
- 5 **(Freeze/Hold)**  
(Page 22)
- 6 **(Subpage)**  
(Page 22)
- 7 **0 - 9**  
Set the channel in TV and DTV mode. Enter the desired numbers or letters. Set the page in Teletext mode.
- 8 **(Flashback)**  
Press to return to the previous image in normal viewing mode.
- 9 **DTV**  
Press to access DTV mode while watching other input sources, and vice versa.  
(Will not work if you were watching DTV immediately before turning off the TV. In this case first select any other input source except DTV using the button.)
- 10 **(Sound mode)**  
Select the sound multiplex mode. (See below.)
- 11 **(Mute)**  
Sound on/off
- 12 **(+/-) (Volume)**  
Increase/decrease volume.
- 13 **LIST**  
DTV: Display the programme list.

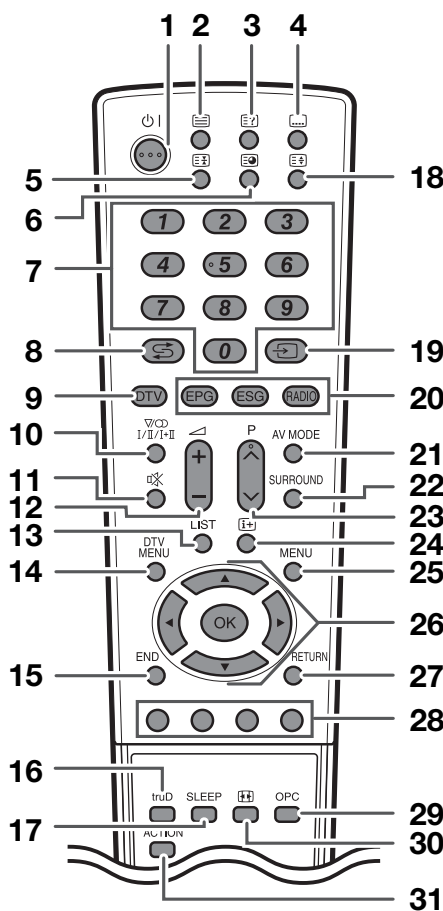

- 14 **DTV MENU**  
DTV: Display DTV Menu screen.
- 15 **END**  
Exit the menu screen.
- 16 **truD**  
Demonstrate the truD effects in a dual screen format. (Page 14)
- 17 **SLEEP**  
Set the sleep timer on (in units of 30 min. up to max. 2hr. 30min) and off. (If the "Time and date" screen is displayed, enter the time and date as explained on page 18, and set the sleep timer again.)
- 18 **(Top/Bottom/Full)**  
Set the area of magnification in analogue teletext mode. (Page 22)
- 19 **(INPUT SOURCE)**  
Select an input source. (TV, DTV, EXT1, EXT2, EXT3, EXT4, EXT5, EXT6) (Page 19)
- 20 **EPG**  
DTV: To display EPG (Electronic Programme Guide) screen.
- 21 **ESG**  
DTV: To display ESG (Electronic Service Guide) screen.
- 22 **RADIO**  
DTV: Switch between RADIO and DTV mode.
- 23 **AV MODE**  
Select a video setting. (Page 19)
- 24 **SURROUND**  
Surround effects on/off.
- 25 **P (▲/▼)**  
Select the channel. In analogue TV mode, external input sources (EXT 1 - 6) can also be selected.
- 26 **(Display information)**  
(Pages 18, 19, 30 and 31)
- 27 **MENU**  
MENU screen on/off. (Page 12)
- 28 **(Cursor)**  
Select a desired item on the setting screen.
- 29 **OK**  
Execute a command within the menu screen. Display the station list in analogue mode and the programme list in DTV mode.
- 30 **RETURN**  
Return to the previous menu screen.
- 31 **Colour (Red/Green/Yellow/Blue)**  
TELETEXT: Select a page. (Page 22)  
The coloured buttons are used to select correspondingly to the coloured items in the menu screen.
- 32 **OPC**  
To switch the Optical Picture Control on and off. (Page 19)
- 33 **(Wide modes)**  
Select the wide mode. (Page 20)
- 34 **ACTION (Action mode)**  
This button is not available in case of using LC-37/42XD1E models.

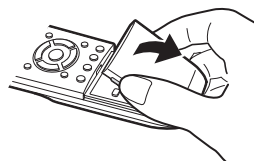

● Using on the remote control unit

**DTV mode:**

Press to open the multi audio screen. (Page 32)

**Analogue TV mode:**

Each time you press , the mode switches as illustrated in the following tables.

**NICAM TV broadcasts selection**

Signal	Selectable items
<b>Stereo</b>	Stereo, Mono!
<b>Bilingual</b>	Dual-channel Sound 1, Dual-channel Sound 2, Dual-channel Sound 1+2, Mono!
<b>Monaural</b>	NICAM, Mono!

**A2 TV broadcasts selection**

Signal	Selectable items
<b>Stereo</b>	Stereo, Mono!
<b>Bilingual</b>	Dual-channel Sound 1, Dual-channel Sound 2, Dual-channel Sound 1+2
<b>Monaural</b>	Mono

**NOTE**

- When no signal is input, the sound mode will display "Mono".
- "Mono!" indicates that you have manually changed to FM mono.

## Quick guide

### Turning on the power

Press  on the TV.

### Standby mode

Press  on the remote control unit when the TV is on.

- The TV enters standby mode and the image on the screen disappears.
- The  indicator on the TV changes from green to red.
- To completely turn off the power to the TV, unplug the AC cord from the AC outlet. However, do not unplug the AC cord unless otherwise instructed.

### Display status indicator

Off	Power off
Red	The TV is in standby mode.
Green	The TV is on.

#### NOTE



- If you are not going to use this TV for a long period of time, be sure to remove the AC cord from the power outlet.
- Weak electric power is still consumed even when  is turned off.
- In DTV input mode, if the power is turned off immediately after a setting change from the menu screen, the new setting or channel information may not be memorised.

### Initial auto installation (Analogue)

When the TV powers on for the first time after purchase, the initial auto installation (Analogue) is invoked. Follow the menus and make the necessary settings one after another.

#### NOTE

- To reconfigure the initial auto installation settings, go to "Channels" and run "Search wizard" from the Setup menu. (Page 16)

- 1 Setting the on-screen display language**
  - ① Press  to select the desired language listed on the screen.
  - ② Press **OK** to enter the setting.
- 2 Setting the country ("Location of TV set" screen)**
  - ① Press  to select your country or area listed on the screen.
  - ② Press **OK** to enter the setting.
  - An overview of settings to be used for auto search displays.
- 3 Press **OK** to start the search.**
  - The TV searches for, sorts and stores all the receivable TV stations according to their settings and the connected antenna.
  - To abort the initial auto installation in progress, press **END**.
- 4 When the auto sorting is completed, the item "Decoder" displays. Press  to select "EXT 1" or "EXT 2", and then press **OK**.**
  - Make sure to select the terminal (EXT 1 or 2) to which the decoder is connected.
- 5 A message appears indicating that the first installation is successfully completed. Press **OK**, if necessary.**
  - If a recording device with AV-Link is connected to EXT 2, the TV automatically starts transferring the station list data to the recording device.

### Initial auto installation (DTV)

Digital Video Broadcasting is a transmission scheme. It is much more than a simple replacement for existing analogue television transmission. DVB provides more stations, clearer picture quality and other services displayed on the screen. It also allows a range of new features and services including subtitles and multiple audio tracks.

To watch DTV broadcasts, follow the procedures below to scan all available services in your area.

#### NOTE

- **Make sure to perform Initial auto installation (Analogue) outlined in the preceding section as well, even if you intend to view only DTV broadcasts.**

- 1** Press **DTV** (or ) , then  to select "DTV", and then press **OK** to access the DTV mode.
- 2** Press **DTV MENU** and the DTV Menu screen displays.
- 3** Press  to select "Installation".
- 4** Press  to select "Auto Installation", and then press **OK**.  
If you have already set the PIN, enter it here. If not, enter the factory preset PIN "1234".
  - See page 17 for setting PIN.
  - A confirmation message displays. Press  to select "Yes", and then press **OK** to start the search.
- 5** The TV starts scanning all available DTV and radio services in your area.

#### NOTE

- The language and country settings used in this operation are the settings you have already set while executing the **Initial auto installation (Analogue)**. If you want to reconfigure the country setting, for instance after moving to another country, conduct "Search wizard" from the Analogue Menu again. (Page 16)
- The DTV services are searched and stored according to the channel number information embedded in the TV signal (if available). If the information is not available, the services are stored according to the order in which they were received. If you would like to sort the order, it is possible to arrange it as explained in page 25.
- To cancel the scan in progress, press **END**.
- You cannot select any DTV-related menu items unless "Auto Installation" has been completed.

## Channel selection using the station list (Analogue)

This section explains how to change/delete/move/rename stations using the analogue Station List. If you are watching DTV, refer to the “Using the digital programme list” section. (Page 31)

You can also select the desired channel from station list instead of using 0 - 9 numeric buttons or P (▲/▼).

- In analogue TV mode, press **OK** when no other menu screen is active.

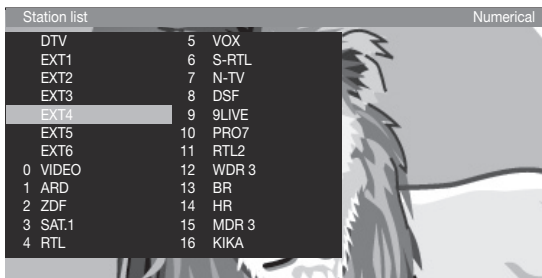

- Press ▲/▼/◀/▶ or 0 - 9 to select the desired station in the station list, and then press **OK** to tune in the station.
  - Press **Blue** to sort the list according to “Alphabetical” or “Numerical”.
  - Refer to the following table for how each numeric button is assigned a set of characters.

## Entering characters using the 0 - 9 buttons

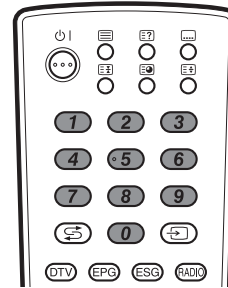

Buttons	Assigned characters and numbers
0	0
1	1, +, -, . (dot), (space)
2	A, B, C, 2
3	D, E, F, 3
4	G, H, I, 4
5	J, K, L, 5
6	M, N, O, 6
7	P, Q, R, S, 7
8	T, U, V, 8
9	W, X, Y, Z, 9

## To delete, move, and rename stations from the station list

While in the station list, press **Yellow** (Change stations).

- Delete**  
 Select a station to delete, and then press **Red** (Delete). Mark more stations with ▲/▼/◀/▶ or 0 - 9, if desired. Confirm with **OK** or cancel with **Red**.
- Move**  
 Select a station to move, and then press **Yellow** (Move). Mark more stations with ▲/▼/◀/▶ or 0 - 9, if desired. Press **OK** to finish marking. Press ▲/▼/◀/▶ or 0 - 9 to select the position to move to. Confirm with **OK** or cancel with **Yellow**.
  - Make sure to select the appropriate block of channels or destination when moving.
- Rename**  
 Select a station to rename, and then press **Blue** (Rename). Press any of the numeric buttons 0 - 9 to select the desired character. Remember to press and toggle the numeric button quickly, for the transition to the next digit is rather quick. Repeat until the new name is fully spelt out. Confirm with **OK** or cancel with **Blue**.
  - The name can be up to 8 characters.

# Using external equipment

## Setting the input source

To view external source images, select the input source using on the remote control unit. (Page 19)

### NOTE

- The cables marked with \* are commercially available items.
- TV-OUT from EXT 1 outputs DTV image when DTV is selected as the input. Otherwise it constantly outputs analogue TV image.
- MONITOR OUTPUT from EXT 2 outputs audio only when EXT 4, 5 and 6 is selected as the input.

INPUT SOURCE
TV
DTV
EXT1
EXT2
EXT3
EXT4
EXT5
EXT6

## Connecting a VCR

You can use the EXT 2 terminal when connecting a VCR and other recording equipment. If your VCR supports TV-VCR advanced AV Link systems, you can connect the VCR using the fully-wired SCART cable.

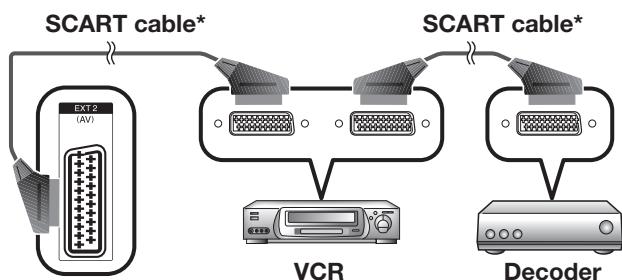

EXT 2 (recommended)

### NOTE

- If the above is your connection, make sure to select "EXT 2" under the menu item "Decoder" when you run the Initial auto installation (Analogue) (Page 8) or when changing the setting later (Page 15).
- TV-VCR advanced AV Link systems may not be compatible with some external sources.

## Connecting a game console or camcorder

A game console, camcorder and some other audiovisual equipment are conveniently connected using the EXT 3 terminals.

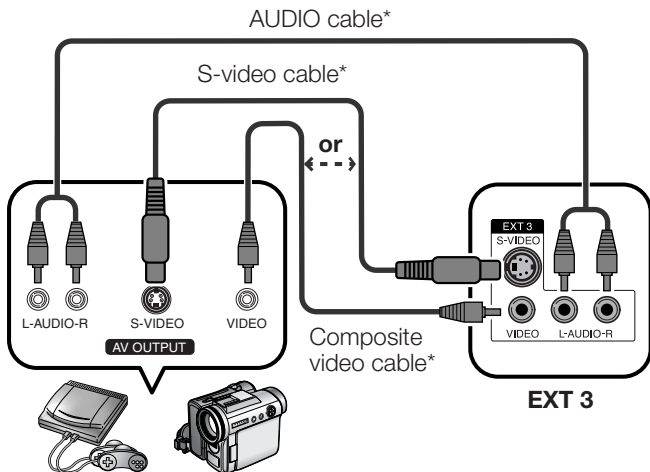

Game console Camcorder

### NOTE

- EXT 3: The S-VIDEO terminal has priority over the VIDEO terminals.

## Connecting a DVD player

You can use the EXT 3, 4, 5 (HDMI) or 6 (HDMI) terminals when connecting to a DVD player and other audiovisual equipment.

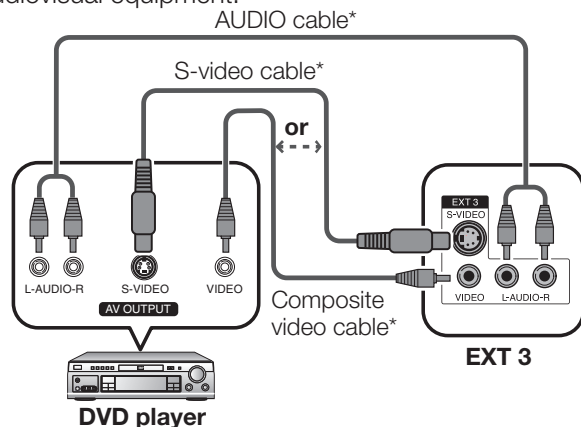

### NOTE

- EXT 3: The S-VIDEO terminal has priority over the VIDEO terminals.

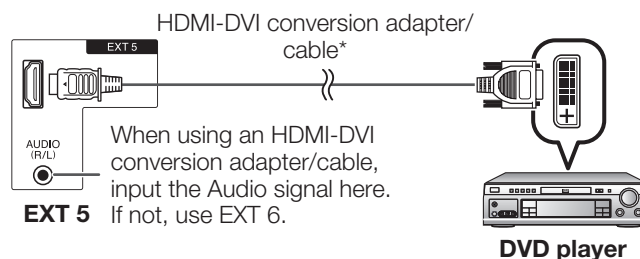
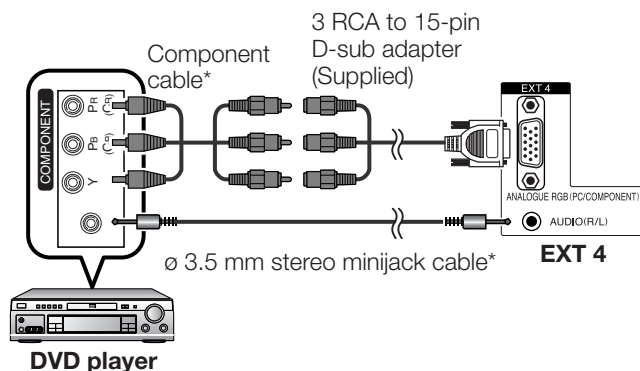

When using an HDMI-DVI conversion adapter/cable, input the Audio signal here. If not, use EXT 6.

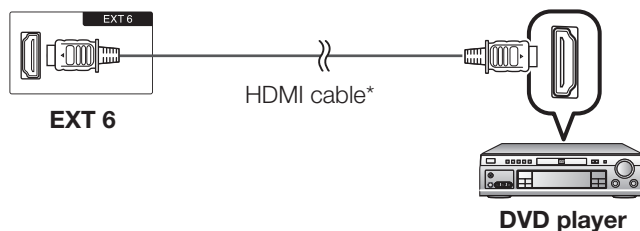

### NOTE

- When connecting an HDMI-DVI conversion adapter/cable to the HDMI terminal, the image may not come in clearly.

## Using external equipment

### Connecting a decoder

You can use the EXT 1 terminal when connecting a decoder and other audiovisual equipment.

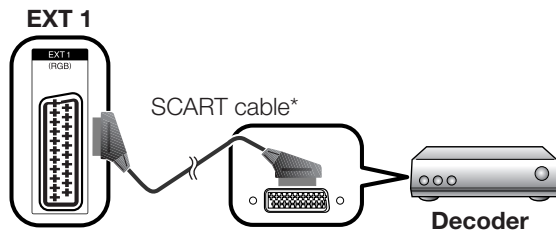

#### NOTE

- If the above is your connection, make sure to select "EXT 1" under the menu item "Decoder" when you run the initial auto installation (Analogue) (Page 8) or when changing the setting later (Page 15).

### Connecting a PC

Use the EXT 4 terminals to connect a PC.

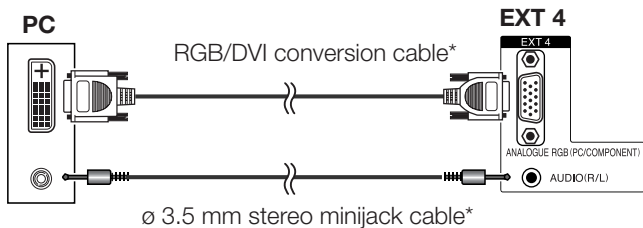
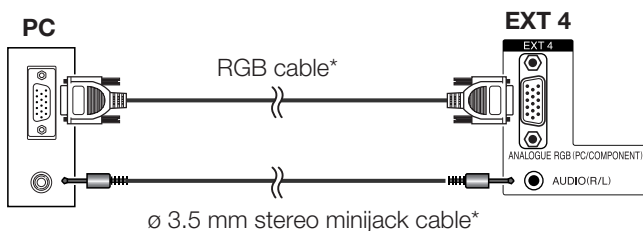

#### NOTE

- The cables marked with \* are commercially available items.
- The PC input terminals are DDC1/2B-compatible.
- Refer to page 34 for a list of PC signals compatible with the TV.
- Macintosh adaptor may be required for use for some Macintosh computers.
- When connecting to a PC, the correct input signal type is automatically detected.

### Using AV Link function

This TV incorporates four typical AV Link functions for smooth connections between the TV and other audiovisual equipment.

#### One Touch Play

While the TV is in standby mode, it automatically turns on and plays back the image from the audiovisual source (e.g. VCR, DVD).

#### TV Standby

When the TV enters standby mode, the connected audiovisual equipment (e.g. VCR, DVD) enters standby mode as well.

#### WYSIWYR (What You See Is What You Record)

When the remote control unit of the connected VCR has the WYSIWYR button, you can automatically start recording by pressing the WYSIWYR button.

#### Preset Download

Automatically transfers the channel preset information from the tuner on the TV to the one on the connected audiovisual equipment (e.g. VCR) via the EXT 2 terminal.

#### NOTE

- Refer to operation manuals of each external equipment for the details.
- Only works when the audiovisual equipment is connected to the EXT 2 terminal on the TV with AV Link via a fully wired SCART.
- The use of the AV Link function is only possible if the TV-set has enforced a complete auto-installation with the connected audiovisual equipment (Page 8, initial auto installation).  
The availability of the AV Link function depends on the audiovisual equipment used. Depending on the manufacturer and type of equipment used, it is possible that the described functions may be completely or partially unusable.

# Menu operations

## On-Screen Display

### Example

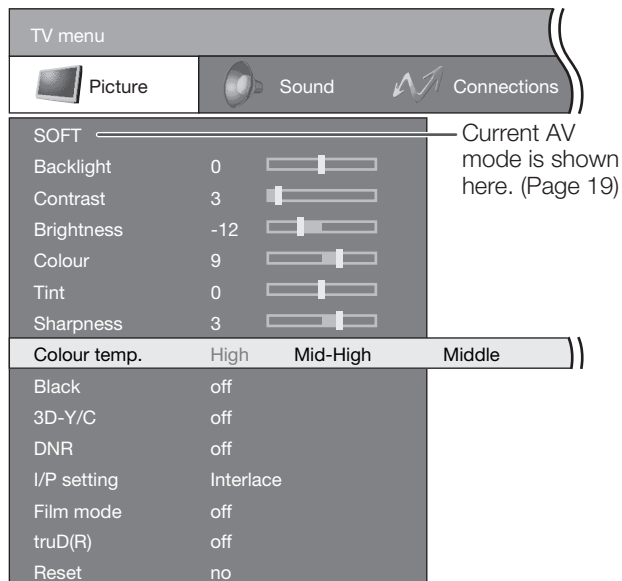

#### Item highlighted in yellow

- This indicates the item currently selected.

#### Item displayed in white

- This indicates an item can be selected.

### NOTE

- Some menu items do not appear as explained in this manual depending on the selected parameter, input mode or the type of signal received.
- The screens in the operation manual are for explanation purposes (some are enlarged, others cropped) and may vary slightly from the actual screens.

## Common operations

- Press **MENU** and the TV menu screen displays.
- Press **◀/▶** to select the desired menu, and then press **OK**.
- Press **▲/▼** to select the desired menu item. Press **OK** to proceed if necessary.

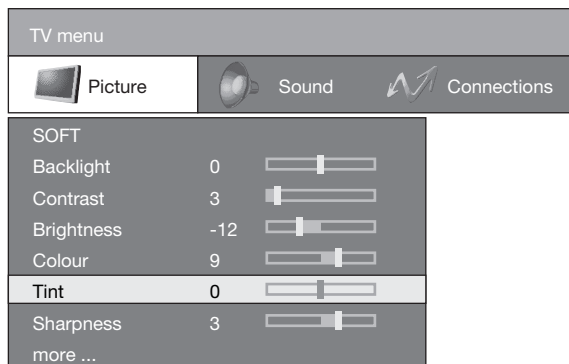

- Press **▲/▼** to select "more..." and then press **OK**, if the item you want to adjust is not displayed.

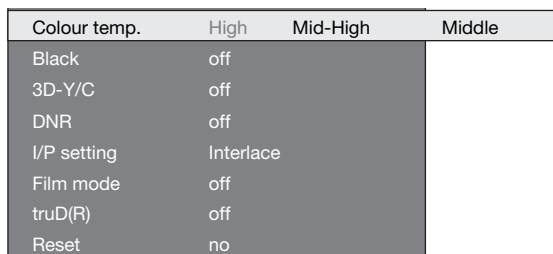

- Press **◀/▶** to select the desired item or move the item to the desired position. Press **OK** if necessary.
- Press **RETURN** repeatedly to return to the last menus, or press **END** or **MENU** to exit the menu.

## Menu operation without a remote control

This function is useful when there is no remote control within your reach.

### Adjusting frequently adjusted items

- Press **MENU** briefly to display the direct control screen.
  - You can adjust the following items: "INPUT SOURCE", "Brightness", "Contrast", "Wide modes" and "Service".
  - "Service" is the item reserved only for service personnel.
- Select the item by pressing **P ▲/▼**.
- Select or adjust by pressing **◀ +/–**.

### NOTE

- The direct control menu screen will disappear if left unattended for several seconds.



## Menu operations

### Picture menu

Various picture-related settings can be optimised.

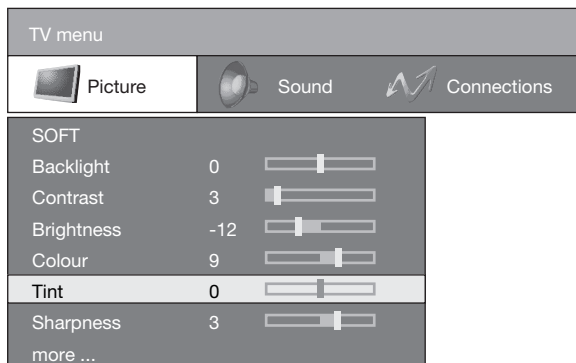

#### NOTE

- Items with \* can be adjusted and reset for each individual AV mode.
- Items with \*\* appear only when "PC (RGB)" for EXT 4 is selected under "Input select".
- Press ▲/▼ to select "more..." and then press **OK**, if the item you want to adjust is not displayed.

#### Backlight\*

Dims or brightens the screen.

#### Contrast\*

The contrast settings depend on the brightness of the room. The brighter the surroundings the higher the contrast should be set.

#### Brightness\*

Set the brightness so that the black areas of the picture only appear black.

#### Colour\*

Set the colour intensity according to your personal taste. The colours should appear natural which is best recognizable from the colour of peoples' faces, for example.

#### Tint

Set the tint so that the colours appear natural. This can be judged from the colour of peoples' faces, for example.

#### Sharpness\*

Adjust the sharpness to obtain the desired image definition.

#### Red\*\*

PC only

Adjust red colour intensity.

#### Green\*\*

PC only

Adjust green colour intensity.

#### Blue\*\*

PC only

Adjust blue colour intensity.

#### Colour temp.\*

Adjust the colour temperature to give the best white image.

##### Item

**High:** White with bluish tone

**Mid-High:** Intermediate tone between High and Middle

**Middle:** Natural tone

**Mid-Low:** Intermediate tone between Middle and Low

**Low:** White with reddish tone

#### Black

For easier viewing, change the viewing depth by selecting a level for automatically adjusting the dark portion of an image.

#### 3D-Y/C

Provide high quality images with minimal dot crawl and cross colour noise by detecting changes in the image.

##### Item

**off:** No detecting

**Standard:** Normal adjustment

**Fast:** Set the optimum image quality for fast-moving images.

**Slow:** Set the optimum image quality for slow-moving images.

#### NOTE

- 3D-Y/C may not operate depending on the input signal type or noisy input signal.
- 3D-Y/C has even more effect on composite video signals (CVBS).

#### DNR (Digital Noise Reduction)

Produce a clearer image. (off, High, Low)

#### I/P setting

Adjust the image and input signal can give you a more beautiful picture.

##### Item

**Interlace:** Display finely detailed images for TV or video, etc.

**Progressive:** Display smooth images for still images or graphics, etc.

#### NOTE

- The I/P setting is set to "Progressive" when Film mode is "on".

## Menu operations

---

---

### Film mode

Automatically detects a film-based source (originally encoded at 24/25 frames/second, depending on the vertical frequency), analyses it and then recreates each frame for film-like picture quality.

---

---

### truD(R)

“truD(R)” ensures you steady motion instead of edgy movements and juddering. It further improves the image quality by enhancing contrast and sharpness with advanced video algorithms. When entering the “truD(R)” menu, you can only switch the juddering correction on/off. The picture quality adjustments such as enhanced contrast and sharpness is always on.

#### NOTE

- Press **truD** on the remote control unit to show truD demonstration in a dual screen format.
- This effect is greater on fast moving images such as film contents.
- If “truD(R)” is activated the items “I/P setting” and “Film mode” will not be displayed in the menu screen.
- “truD(R)” will not be displayed in the menu screen depending on the type of signal received (HD signal, etc.).

---

---

### Reset

Select if you wish to reset all picture-related items to the factory presets.

---

---

## Sound menu

Various sound-related settings can be optimised.



#### NOTE

- Items with \* can be adjusted and reset for each individual AV mode.
- Press **▲/▼** to select “more...” and then press **OK**, if the item you want to adjust is not displayed.

---

---

### Treble\*

For weaker or stronger treble

---

---

### Bass\*

For weaker or stronger bass

---

---

### Loudness

Boosts low and high frequencies to give added punch to playback even at a low volume level.

---

---

### Auto volume

The volume may vary when receiving stations with different standards or when switching from station to station or during commercial breaks. You can reduce these differences in volume by activating Auto volume. Switch off the automatic function for the reception of music programmes and live broadcasts for a better sound.

---

---

### Balance

Set the balance to achieve equal volume from the right and left sides.

---

---

### Clear voice

This function emphasises speech voice against the background noise for more intelligibility. It is not recommended for music sources.

---

---

### Reset

Select if you wish to reset all sound-related items to the factory presets.

## Menu operations

### Connections menu

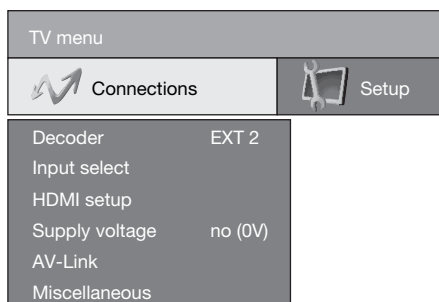

### Decoder

Make sure to select the terminal (EXT 1 or 2) to which the decoder is connected.

#### NOTE

- This setting will be reflected in the “Decoder stations” function under “Miscellaneous”. (Page 16)

### Input select

For setting the signal type of external equipment.

Input source	Signal type
EXT 1	Y/C, CVBS, RGB
EXT 2	Y/C, CVBS
EXT 4	PC (RGB), COMPONENT

#### NOTE

- **If no (colour) image displays, try to change the other signal type.**
- Check the operation manual of the external equipment for the signal type.
- TV, DTV, EXT3, EXT5 and EXT6 are not displayed in Input Select.
- If both CVBS and RGB signals are input to EXT 1 using a SCART cable, the TV may output an RGB signal even though you have designated CVBS for the respective terminal. This happens due to the setting of your external equipment.

### HDMI setup

HDMI (High-Definition Multimedia Interface) terminal selection.

- 1 Press **MENU** and the TV menu screen displays.
- 2 Press **◀/▶** to select “Connections”, and then press **OK**.
- 3 Press **▲/▼** to select “HDMI setup”, and then press **OK**.
- 4 Press **▲/▼** to select “EXT5” or “EXT6”, and then press **OK**.
- 5 Press **▲/▼** to select the desired item.
- 6 Press **◀/▶** to select the desired setting.

HDMI setup items	Selectable items	Description
Signal type*	RGB/YCbCr 4:4:4/YCbCr 4:2:2	Select the video signal type from the HDMI terminal.
Colour matrix*	ITU601/ITU709	Select the internal colour space conversion method when an RGB signal is input.
Dynamic range*	Normal/ Enhanced	Select the signal amplitude range. Usually, select “Normal”.
Auto view	Enable/Disable	Set whether or not to use Wide mode based on signal recognition, including an HDMI signal.
Audio select**	Digital/Analogue	Select “Digital” for audio signal via the HDMI terminal. Select “Analogue” for audio signal via the AUDIO jack.

#### NOTE

- Refer to your external equipment operation manual for the signal type.
- Items with \* may be greyed out depending on the type of signal input from the external equipment.
- Item marked \*\* is only available when EXT5 is selected.

## Menu operations

### Supply voltage

Antennas with an integrated amplifier need a supply voltage on the antenna line. (Page 4)

### AV-Link (EXT 2 only)

With this function you can transfer the station data of the TV (such as station preset number/name/channel/frequency) to the recorder if the recorder is set up for AV-Link. This function is available only for conventional analogue stations.

- 1 Press **MENU** and the menu screen displays.
- 2 Press **◀/▶** to select "Connections", and then press **OK**.
- 3 Press **▲/▼** to select "AV-Link", and then press **OK**.
- 4 Select "Start transmission", and then press **OK**.
  - The TV transfers the station list to the AV-Link recorders connected to EXT 2.

### Miscellaneous

#### ● Decoder stations

Encrypted stations should be labelled as decoder stations, so that they can be decoded automatically by the connected decoder.

Items	Description
Select decoder station(s)	Press <b>OK</b> to mark an encoded station. The marking can be removed from a station that has already been marked by pressing the same key.
Sound encoding	For reception of encoded audio signals select either "always" if these are always encoded or "Automatic" if these are sometimes encoded. For audio signals which are always unencoded, select "never".

#### ● Manual adjustment of AV standard

Ask your dealer which standard to select for specific AV equipment (if it is not recognised automatically). Select the appropriate external terminal (EXT 1- 3) and its AV standard as advised.

#### ● Allow switching voltage

If this function is activated and you switch to an AV device (connected to EXT 1 or 2) that delivers switching voltage to playback, its picture and sound will be reproduced immediately at all TV presets. (This function is available only for analogue TV and DTV mode.)

## Setup menu

You can search for stations automatically or manually as well as set the menu language, time and date, child lock, on-screen displays, etc.

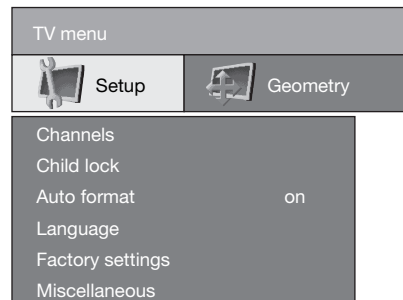

### Channels

The menu contains the automatic station search and the manual station settings. You can re-sort stations, enter and change station names, and delete stations.

#### ● Search wizard

Use this menu to search for stations automatically once certain settings have been made. (See page 8, **Initial auto installation (Analogue)** for details.)

- 1 Press **MENU** and the TV menu screen displays.
- 2 Press **◀/▶** to select "Setup", and then press **OK**. Press **▲/▼** to select "Channels", and then press **OK**. Press **▲/▼** to select "Search wizard", and then press **OK**.
  - You will get a table for the auto station search.
- 3 If necessary select "Change search settings", and then press **OK**. Otherwise skip to step 8.
- 4 Press **▲/▼/◀/▶** to select your country or area listed on the screen, and then press **OK**.
- 5 Indicate whether you wish to have "all" stations or "new ones only" searched for using **◀/▶**, and then press **OK**.
- 6 Select the desired TV/colour standard, and then press **OK**.
- 7 Specify from which station position onwards the stations are to be stored, and then press **OK**.
- 8 Press **▲/▼** to select "Start search", and then press **OK**.

#### NOTE

- The station search may take some time.
- Do not make any entries or switch off the set during this time.
- When the search has ended you will be shown the found and stored stations sorted in numerical order.
- After the station search has been completed, close the table by pressing **END**.

## Menu operations

### ● Manual tune

Use the manual tune option when receiving TV signal whose TV/Colour standard deviate from the one specified already. However, this requires detailed knowledge.

- 1 Press **MENU** and the TV menu screen displays.
- 2 Press ◀▶ to select "Setup", and then press **OK**.
- 3 Press ▲▼ to select "Channels", and then press **OK**.
- 4 Press ▲▼ to select "Manual tune", and then press **OK**.
- 5 Now enter the necessary setting parameters for each menu item.
  - For "Channel" and "Frequency", you can initiate the search by pressing **Blue** (Search) or simply enter the number if you know it.
  - For items "TV stand." and "Col. standard", you must first press **OK** (Adopt) to confirm the change.
- 6 When you have finished the adjustments, press **Red** (Store) to store the new settings.
- 7 Next, select the channel position to store the new settings. Press **Red** to overwrite the current station or **Blue** to insert the new channel.

#### Item

**Channel:** You can enter the channel number directly here. Press ◀▶ to move between the receiving channel modes.

**Frequency:** You enter the frequency directly using the numeric buttons. For fine tuning, use the ◀▶ buttons. Fine tuning may be necessary for analogue channels or for recorder playback via the antenna connection.

**Name:** You can enter an 8-character channel name. Refer to page 9 for the character input method.

**TV stand.:** Ask your dealer which standard to select for specific channels or AV equipment. (B/G, I, L, D/K)

**Col. standard:** Ask your dealer which standard to select for specific channels or AV equipment. Selectable colour standard varies depending on the selected TV standard. (Auto, PAL, SECAM)

### ● Change stations

You can move stations, enter or change station names, and delete stations. The operation is the same as explained in page 9, "**To delete, move, and rename stations from the station list**".

### Child lock

With the child lock you can bar access to all stations immediately or daily for a certain time period. To use this function, you have first to define your PIN.

#### NOTE

- To view a locked channel, you must enter the PIN. (See page 28 for locking channels from viewing in DTV mode.)
- The TV power will be turned off if no PIN is entered for several seconds.

### ● Lock immediately

You can lock out all stations immediately by selecting "yes". The lock is effective immediately and effective whenever you turn on the TV.

### ● Lock daily

Here, enter the daily time period, for which your TV set is to be locked.

### ● Change PIN

This allows you to change your PIN.

#### NOTE

- When in analogue TV mode, the current PIN becomes invalid if you choose "no" for both "Lock immediately" and "Lock daily".
- **As a precautionary measure, make a note of your PIN on the back of this operation manual, cut it out and keep it in a safe place that children cannot reach.**
- **See page 33 if you lose or forget your PIN.**

### Auto format

When Auto format is switched on, the TV recognises the wide picture mode for Cinemascope or widescreen films and adjusts itself accordingly.

#### NOTE

- Use Wide modes if an image does not switch to the desired screen format.
- When 4:3 picture format (i.e., "Normal") is manually selected using the Wide modes function, the Auto format function is temporarily disabled. Select another input source or reset the TV power to restore the Auto format function, and the 4:3 picture format will be automatically selected depending on the transmitted signal.

### Language

You can select a language from the Setup menu. Select from among 13 languages. (Dutch, English, Finnish, French, German, Greek, Italian, Polish, Portuguese, Russian, Spanish, Swedish, Turkish)

### Factory settings

Call up the predefined sound and picture factory settings. Unlike the "Reset" options provided in the Picture and Sound menus, this will reset all parameters to the default value all across the various input modes and AV mode options.

## Menu operations

### Miscellaneous

#### ● No signal off

When set to "Enable" the TV will automatically enter the standby mode if there is no signal input for 6 minutes.

TV menu ->Setup		
Miscellaneous	Channels	Child lock
No signal off	Enable	Disable
On-screen displays		
Time and date		

#### NOTE

- When a TV programme finishes, this function may not operate.
- This function is not available in DTV mode.

#### ● On-screen displays

Here you can determine which on-screen displays are to be shown by pressing **i+** on the remote control.

Items	Description
On-screen display time	Sets the duration of the TV status and station name display. <ul style="list-style-type: none"> <li>• This setting also affects other TV screens. (Volume, Surround, etc.)</li> </ul>
Sound mode	Sound mode display on/off ("yes"/"no")
Time	Time information display on/off ("yes"/"no")

#### ● Time and date

When you receive teletext, the correct date and time setting is picked up automatically by the set. If you do not receive teletext, you should set the "Date" and "Time" manually. Also you have additional items you can adjust as outlined below.

#### NOTE

- Time and date information configured manually cannot be overridden automatically by the set.
- If the power to the set is cut off (disconnection of AC cord, power outage, etc.), the auto time acquisition mode through teletext reactivates.

Items	Description
Time	If you receive a station with teletext after switching on your TV set, the time and date are automatically registered. In the case of some stations, the date may have to be entered manually. For stations without teletext, enter the time (00:00 to 23:59) and the date (day.month.year) using the numeric buttons on the remote control.
Date	See the above item "Time".
Beginning of daylight-saving time	Enter the date for the beginning of daylight-saving time if it deviates from the date calculated automatically.
End of daylight-saving time	Enter the date of the end of daylight-saving time if it deviates from the date calculated automatically.

### Geometry menu

You can set the geometry values of the picture such as picture position and phase relation. The adjustments are stored independently for each input mode.

TV menu		
Geometry	Picture	
Picture horizontal	0	
Picture vertical	0	
Phase position	0	

#### Picture horizontal

Sets the horizontal picture position by moving the picture left and right.

#### Picture vertical

Sets the vertical picture position by moving the picture up and down.

#### Phase position

PC only

Adjusting the phase relation ensures a picture without flicker and noise. (Available only for RGB signal)



## Menu operations

### Other menu items

Some of the useful features can be directly called up by pressing assigned buttons on the remote control.

### AV mode

AV mode gives you five viewing options to choose from to best match the system environment, which can vary due to factors like room brightness, type of programme watched or the type of image input from external equipment.

- 1 Press **AV MODE**.
  - The AV mode menu displays.
- 2 Press **AV MODE** or **▲/▼** while the AV mode menu displays on the screen.
  - As you toggle down the options, each is immediately reflected on the screen. No need to press **OK**.

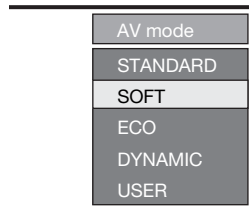

#### Item

- STANDARD:** For a highly defined image in a normally bright room (Enhanced Picture Contrast: On)
- SOFT:** Creates a softer image. (Enhanced Picture Contrast: On)
- ECO:** Reduces power consumption. (Enhanced Picture Contrast: Off)
- DYNAMIC:** For a clear-cut image emphasising high contrast for sports viewing. (Enhanced Picture Contrast: On)
- USER:** Allows the user to customise settings as desired. You can set the mode for each input source. (Enhanced Picture Contrast: Off)

#### NOTE

- You can adjust the factory presets given in "STANDARD", "SOFT", "ECO" and "DYNAMIC".
- You can assign different AV mode to each external input source.
- Enhanced Picture Contrast technology detects the source video characteristics and smoothly adjusts the screen brightness accordingly, enabling deeper black levels.
- Enhanced Picture Contrast is activated when you turn the OPC function off for the items "STANDARD", "SOFT" and "DYNAMIC" in AV mode.

### Status display

Press **(i+)**, a status display appears for a few seconds.

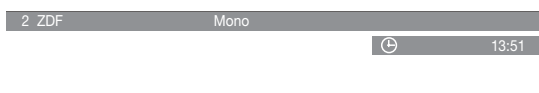

- In the top line you can see the name of the programme. See page 18 for how to customise the settings for the status display.

### INPUT SOURCE

Use the INPUT SOURCE screen to select/check the external equipment connected to the terminal(s) on the back of the TV.

- 1 To watch images from external AV equipment, press **→**. (Page 10)
  - To close the INPUT SOURCE screen, press **→** again.
- 2 Press **▲/▼** to select the corresponding terminal, and then press **OK**.

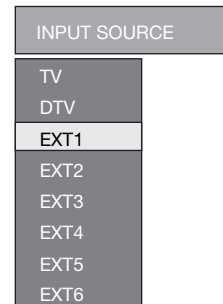

### Still image

You can freeze a motion picture on the screen.

- 1 Press **(S)**.
- 2 Press **(S)** again to exit still image.

#### NOTE

- This function may not be available depending on signal condition.

### OPC

Automatically adjusts the brightness of the screen.

Press **OPC** on the remote control unit to switch the Optical Picture Control on and off.

#### NOTE

- When set to "on", the TV senses the surrounding light and automatically adjusts the backlight brightness. Make sure no object obstructs the OPC sensor, which could affect its ability to sense surrounding light.
- Under the factory default condition, OPC becomes active when you select "ECO" for the AV mode.
- OPC turns off whenever an adjustment is made to the "Backlight" setting.
- OPC can be adjusted and reset for each individual AV mode.

## Menu operations





### Wide modes

You can select the picture size. Selectable picture size varies with the type of signal received.

Basically, if you set Auto format to "on" in the Setup menu, the optimum Wide mode is automatically chosen for every broadcast. You can however, change the screen format manually as explained below.

#### NOTE

- Aside from manually changing the Wide modes as explained herein, the TV may detect and select the optimum Wide mode according to the signal received.

- 1 Press .
  - The Wide modes menu displays.
  - The menu lists the wide mode options selectable for the type of video signal currently received.
- 2 Press  or / while the Wide modes menu displays on the screen.
  - As you toggle down the options, each is immediately reflected on the screen. No need to press **OK**.

#### Item (for SD (Standard) signal)

**Full:** For 16:9 squeeze pictures.

**Normal:** For 4:3 "standard" pictures. A side bar appears on each side.

**Panorama:** In this mode the picture is progressively stretched toward each side of the screen.

**Cinema 16:9:** For 16:9 letterbox pictures. Bars may appear on the top and bottom with some programmes.

**Cinema 14:9:** For 14:9 letterbox pictures. Bars may appear on the top and bottom with some programmes.

#### Item (for HD (High-Definition) signal)

**Full:** Display with the Overscan image. Crop all sides of screen.

**Underscan:** Display with the Underscan image. (Display with the High-Definition image compressed optimally. Noise may appear on the edge of the screen with some programmes.)

### Wide modes

PC only

You can select the picture size.

- 1 Press .
  - The Wide modes menu displays.
- 2 Press  or / to select a desired item on the menu.

#### NOTE

- Connect the PC before making adjustments. (Page 11)
- Selectable picture size may vary with input signal type.

#### EXAMPLE

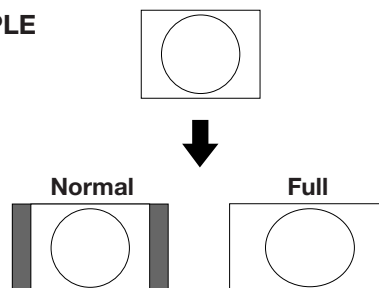

#### Item

**Full:** An image fully fills the screen.

**Normal:** Keeps the original aspect ratio in a full screen display.

## Menu operations

### Analogue Teletext

#### What is Teletext?



Teletext broadcasts pages of information and entertainment to specially equipped television sets. Your TV receives Teletext signals broadcast by a TV network, and decodes them into graphical format for viewing. News, weather and sports information, stock exchange prices and programme previews are among the many services available.

#### Turning on and off Teletext

- 1 Select a TV channel or external input source providing the Teletext programme.
- 2 Press  to display the Teletext.



- Many stations use the TOP operating system, while some use FLOF (e.g. CNN). Your TV supports both these systems. The pages are divided into topic groups and topics. After switching on the teletext, up to 2000 pages are stored for fast access.

- 3 Press  again to display the Teletext on the right screen and the normal image on the left screen.
- Each time you press , the screen switches as shown below.
  - If you select a programme with no Teletext signal, "No text" displays.
  - The same message displays during other modes if no Teletext signal is available.

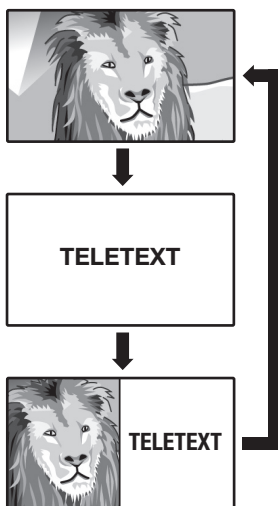

#### NOTE

- Teletext will not work if the selected signal type is RGB.  
(Page 15)

### Using analogue teletext menu

While in the analogue teletext mode, press **MENU** to display the Teletext Menu.

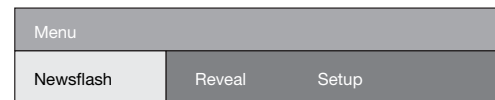

#### Newsflash

If you activate "Newsflash" in the teletext menu, the current page is hidden. The  symbol at the top left shows that the newsflash function is enabled (you are in teletext mode). If its contents are updated and it is a small news window, then this is displayed. If, however, it is a page that fills the screen, the symbol is shown in blue and the page can be displayed by pressing **OK**.

#### Reveal/Conceal

The teletext contains hidden information e.g., for quiz questions or VPS times in programme preview pages. This is the same function as pressing .

## Menu operations

### Setup

Menu			
Setup	Newsflash	Reveal	
Sub-title pages			
Teletext subtitles		with normal size	
Character set	Standard	Russian	Greek
HiText	yes		

#### ● Sub-title pages

Some stations provide teletext subtitles for the hearing impaired. For every station you can enter the teletext page on which subtitles can be found. The factory setting for all stations is page 150. This function can be started by pressing  with the menu screen open.

#### ● Teletext subtitles

This function displays subtitles transmitted via teletext in normal or double size.



#### ● Character set

You can set the teletext language display to the language listed. This is necessary, for example, for Turkish or Polish teletext.

#### ● HiText

HiText (Level 2.5) can be used to select an improved teletext video display. This will be effective as soon as the TV station broadcasts the required information.

### Buttons for teletext operation

Buttons	Description
<b>Colour (Red/Green/Yellow/Blue)</b>	Select a group or block of pages displayed in the coloured brackets at the bottom of the screen by pressing the corresponding <b>Colour (Red/Green/Yellow/Blue)</b> on the remote control unit.
<b>0 - 9</b>	Directly select any page from 100 to 899 by using <b>0 - 9</b> .
<b>⌂ (Top/Bottom/Full)</b>	Switch the Teletext image to Top, Bottom or Full.
<b>⌂ (Reveal hidden Teletext)</b>	Reveal or conceal hidden information such as an answer to a quiz.
<b>⌂ (Freeze/ Hold)</b>	Stop updating Teletext pages automatically or release the hold mode.
<b>⌂ (Subtitle for Teletext)</b>	Display the subtitle or exit the subtitle screen. <ul style="list-style-type: none"> <li>• Subtitle will not be displayed when the service does not contain the subtitle information.</li> </ul>
<b>⌂ (Subpage)</b>	Reveal or hide subpages. <ul style="list-style-type: none"> <li>•   button: Select subpage.</li> <li>• Red button: Move to the previous page.</li> <li>• Green button: Move to the following page.</li> <li>• These two buttons are shown on the screen by the signs <b>-</b> and <b>+</b>.</li> </ul>

# DTV menu operations

## DTV menu operation buttons

Use the following buttons on the remote control unit to operate the DTV Menu.

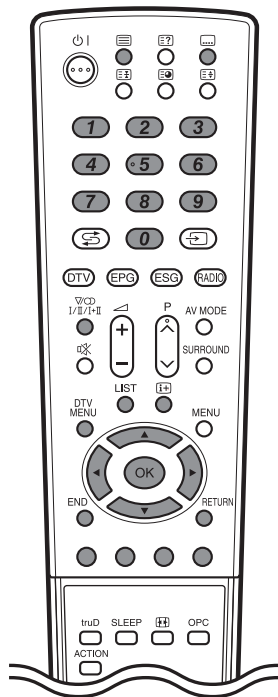

- : Press to display the subtitle selection screen.
- : Press to display TELETEXT or start the MHEG5 presentation, if available.
- 0** - **9**: Aside from direct channel entry, each of the **1** - **9** numeric buttons have a unique function assigned in the Programme Setup screen.
- DTV**: Press to access DTV mode.
- EPG**: Press to open the EPG screen.
- ESG**: Press to open the ESG screen.
- RADIO**: Press to switch between TV and RADIO mode.
  - Due to large variation in transmitted volume levels in RADIO mode, some stations will produce distortion if the volume level is set too high.
- : Press to open the multi audio screen.
- DTV MENU**: Press to open or close the DTV Menu screen.
- LIST**: Press to open the Programme List.
- : Press to open the service banner or view detailed information from the EPG/ESG screen.
- : Press to select a desired item on the screen or adjust a selected item.
- OK**: Press to go to the next step or complete the setting.
  - Press to open the Programme list when no other menu screen is active. (Except external input.)
- END**: Press to exit the current menu screen without saving the changes.
- Colour**: Each of the coloured buttons have a unique function assigned in the menu screen.
- RETURN**: Press to return to the previous step.

## DTV On-Screen Display

### Example

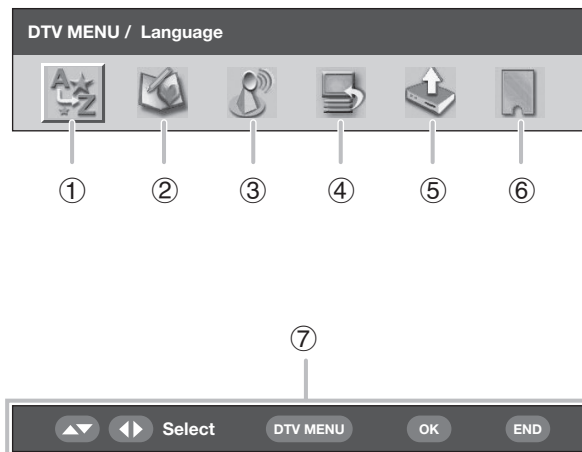

- 1 Language**
  - To customise the language preference for audio and MHEG5 application.
- 2 Programme Setup**
  - To configure various settings for each service. These include: Fav(ourite), Lock, Move, Move To, Skip, Select, Erase, Label, and View functions.
- 3 Installation**
  - To scan all services available in your area, or to label/erase/re-scan the selected carrier.
- 4 System Setup**
  - To configure On-Screen Display and Child Lock settings.
- 5 Accessories**
  - To display the current version of the software or to allow the software upgrade to take place.
- 6 Common Interface**
  - To display the current Common Interface details.
- 7 Navigation buttons**
  - To navigate within the DTV Menu screen.

## DTV common operations

### DTV common menu operation

- 1** Press **DTV** or to access the DTV mode.
- 2** Press **DTV MENU** and the DTV Menu screen displays.
- 3** Press to select the desired menu, and then press **OK** if necessary.
  - From this point, menu operations differ depending on the item you are going to adjust. See the respective section of the menu operation.
  - You cannot select any DTV-related menu items unless "Auto Installation" has been completed.
  - Press **RADIO** to switch between DTV and Radio mode.
  - To exit the current screen without saving the change, press **END**.

## DTV menu operations

### About using the character set screen

In some cases you may be prompted to enter characters. See below for details.

#### Sample Alpha Numerical Character Set screen

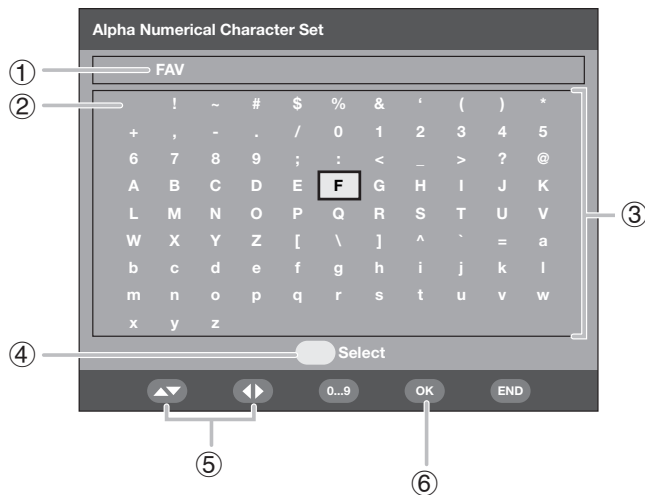

① **Input area**

② **Space**

To add or overwrite with a space.

③ **Character select area**

④ **YELLOW (Select) button**

Press to move between the input area and character select area.

⑤ **▲/▼/◀/▶ button**

Press to move the cursor.

⑥ **OK button**

**While in the input area:**

Confirms the new name.

Once **OK** is pressed to confirm, a confirmation message displays.

Press **◀/▶** to select "Yes", and then press **OK**.

**While in the character select area:**

Confirms the input of a character.

#### Sample operation using Alpha Numerical Character Set

- 1 Call up the character set screen while in the "Label" or "Carrier Setup" screen. (Pages 26 and 27)
- 2 Press **YELLOW (Select)** to move the cursor to the character select area.
- 3 Press **▲/▼/◀/▶** to select the desired character, and then press **OK**. Repeat until the new name is fully entered.
  - Use space to add a space or overwrite.
- 4 To register the new name, press **YELLOW (Select)** to move the cursor back to the input area.
- 5 Press **OK**.
  - A confirmation message displays.
- 6 Press **◀/▶** to select "Yes", and then press **OK**.

## Language

Select language settings for audio (if a programme is broadcast in more than one language) and MHEG5 service.

- 1 Press **OK** while the cursor is on "Language".
- 2 Press **▲/▼** to select "1st Pref. Audio", "2nd Pref. Audio", "3rd Pref. Audio" or "MHEG".
- 3 Select a desired language for each item.

#### NOTE

- See page 17 to change the language displayed on-screen.
- See page 32 to change the subtitle language.
- See page 32 for details on the MHEG5 service.

#### Available language list

Basque	Greek
Catalan	Italian
Croatian	Norwegian
Czech	Polish
Danish	Portuguese
Dutch	Russian
English*	Serbian
Finnish	Slovak
French	Spanish
Gaelic*	Swedish
Gallegan	Turkish
German	Welsh*

\* Languages available for MHEG5 service

## Programme Setup

Configure various settings for each service. Press the preassigned ① - ⑨ numeric buttons to access each of the functions explained below.

Press **OK** while the cursor is on "Programme Setup".

#### Sample Programme Setup screen

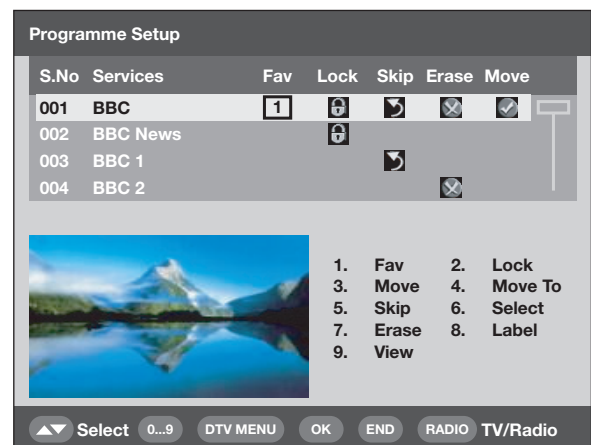

#### NOTE

- The picture window shows a blank image if Radio services are listed.



## DTV menu operations

### Favourite

Assign services to 4 different favourite groups.

- 1 Press ▲/▼ to select the desired service.
- 2 Press ① on the remote control. A selection box displays.
- 3 Press ▲/▼ to register the selected service to any of the 4 favourite groups (None, Fav 1 ... Fav 4) and then press **OK**. An icon displays indicating the favourite status.
  - Do not press **END** to exit the screen here if you wish to register the change.
- 4 Press **OK**.
- 5 Now you can easily select your favourite service from the Programme List. (Page 31)

#### NOTE

- You cannot register the same service to two different favourite groups.

### Lock

When the service is locked, you must enter your PIN whenever you tune to the service.

- 1 Press ▲/▼ to select the desired service.
- 2 Press ② on the remote control. If you have already set the PIN, enter it here. If not, enter the factory preset PIN "1234". An icon displays indicating the service is locked.
  - Pressing ② will turn the lock icon on and off. (PIN entry is required when lifting the lock icon.)
  - Do not press **END** to exit the screen here if you wish to register the change.
- 3 Press **OK**.

#### NOTE

- See page 17 for setting the PIN.

### Move

Sort the order of the selected service by moving the service position.

- 1 Press ▲/▼ to select the desired service.
- 2 Press ③ on the remote control. An icon displays indicating the service to be moved.
  - Pressing ③ will turn the move icon on and off.
- 3 Move the selected service to the desired position using ▲/▼, and then press **OK**.
  - Do not press **END** to exit the screen here if you wish to register the change.
- 4 Press **OK** to register the change.

#### EXAMPLE:

##### Moving "002 ZDF" ahead of "001 ARD".

Default order: Press ▲/▼ to select the desired service in 001←→002←→003←→004.

Sorted order: Press ▲/▼ to select the desired service in 002←→001←→003←→004.

001	ARD	→	002	ZDF
002	ZDF		001	ARD
003	SAT. 1		003	SAT. 1
004	RTL		004	RTL

### Move To

Use this function to change the position of two selected services

- 1 Press ▲/▼ to select the desired service.
- 2 Press ④ on the remote control.
- 3 Enter the number using ① - ⑨ numeric buttons, and then press **OK**. The positions of the selected services are switched.
  - Do not press **END** to exit the screen here if you wish to register the change.
  - You cannot enter a service number that is not listed.
- 4 Press **OK** again, the message "Successfully updated" displays. The change is now registered.

001	ZDF	→	001	RTL
002	ARD		002	ARD
003	SAT. 1		003	SAT. 1
004	RTL		004	ZDF

### Skip

Services that are set to skip will not be picked up when pressing **P** (√/∧).

- 1 Press ▲/▼ to select the desired service.
- 2 Press ⑤ on the remote control. An icon displays indicating the service to be skipped.
  - Pressing ⑤ will turn the skip icon on and off.
  - Do not press **END** to exit the screen here if you wish to register the change.
- 3 Press **OK**.

#### NOTE

- To view services that are set to be skipped, use ① - ⑨ numeric buttons or select from the Programme List.

## DTV menu operations

### Select

Use this function to jump to the specific service in one step. This is useful when there are many services displayed on screen to scroll through.

- 1 Press **6** on the remote control. Now you can change the service number on the left side of the screen.
- 2 Enter the number using **0** - **9** numeric buttons, and then press **OK**. The highlight moves to the selected service.

### Erase

Erase the selected service(s) from the memory.

- 1 Press **▲/▼** to select the desired service.
- 2 Press **7** on the remote control. An icon displays indicating the service to be erased.
  - Pressing **7** will turn the erase icon on and off.
  - Do not press **END** to exit the screen here if you wish to register the change.
- 3 Press **OK**.
  - A confirmation message displays.
- 4 Press **◀/▶** to select "Yes", and then press **OK**.

### Label

Change individual service names.

- 1 Press **▲/▼** to select the desired service.
- 2 Press **8** on the remote control. A character set screen displays.
- 3 Enter new name for the service. See page 24 for operations using the character set screen.

### View

Tune to the service shown in the picture window.

- 1 Press **▲/▼** to select the desired service.
- 2 Press **9** on the remote control.
  - The image shown in the picture window changes.
- 3 Press **END** to exit the Programme Setup screen to view the image in full screen.

## Installation

This section describes how to reconfigure the DTV settings after conducting **Initial auto installation (DTV)** on page 8.

### Auto Installation

The TV automatically detects and stores all available services in your area. See **Initial auto installation (DTV)** on page 8 for details.

#### NOTE

- If the TV detects a new carrier/service that has become available after performing "Auto Installation", the message "Do you want to save?" displays. Press **◀/▶** to select "Yes" or "No", and then press **OK**.

### Carrier Scan

Manually add a new carrier by entering the desired carrier number or frequency band.

- 1 Press **◀/▶** to select "Installation".
- 2 Press **▲/▼** to select "Carrier Scan", and then press **OK**.  
If you have already set the PIN, enter it here. If not, enter the factory preset PIN "1234".

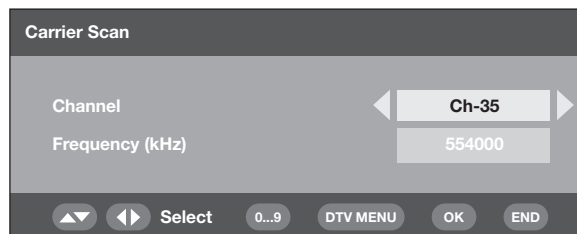

- 3 Press **▲/▼** to select "Channel", then **◀/▶** to enter the carrier number, and then press **OK**.
  - The frequency of the selected carrier in the below cell changes correspondingly.
- 4 After the scan is complete, the screen shows all available services for the selected range.
- 5 A confirmation message displays. Press **◀/▶** to select "Yes", and then press **OK** to save the change.

#### NOTE

- You can directly enter the frequency instead of step 3. In this case, select "Frequency (kHz)", enter the number using **0** - **9** numeric buttons, and then press **OK**. Use **◀/▶** to move between the digits.
- After performing "Carrier Scan", the order stored by using the "Move" function will revert to the default order.
- See page 17 for setting the PIN.

## DTV menu operations

### Carrier Setup

This is provided for you to rename (label), erase, or re-scan carriers. "Carrier" in this context refers to a service station that provides a set of individual services.

- 1 Press **◀/▶** to select "Installation".
- 2 Press **▲/▼** to select "Carrier Setup", and then press **OK**.  
If you have already set the PIN, enter it here. If not, enter the factory preset PIN "1234".

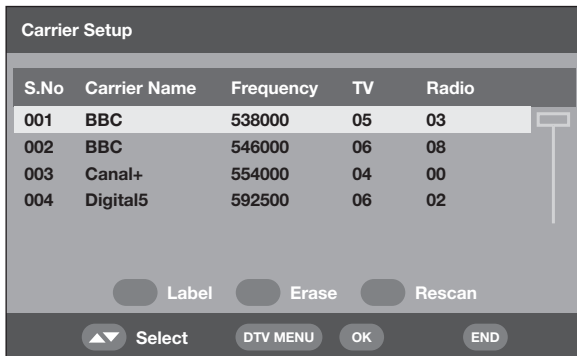

- ① **To rename the selected carrier:**  
Select the carrier, and then press **RED** (Label). The character set screen displays. Enter a new name for the carrier. See page 24 for details on using the character set screen.
- ② **To erase the selected carrier:**  
Select the carrier, and then press **GREEN** (Erase). An icon displays indicating the carrier to be erased. Pressing **GREEN** will turn the erase icon on and off. Press **OK**.  
A confirmation message displays. Press **◀/▶** to select "Yes", and then press **OK**.
- ③ **To re-scan the selected carrier:**  
Select the carrier, and then press **BLUE** (Rescan). Re-scanning starts. A confirmation message displays. Press **◀/▶** to select "Yes", and then press **OK**.

#### NOTE

- After re-scanning the selected carrier, the order stored by using the "Move" function will revert to the default order.

### System Setup

Configure On-Screen Display and Child Lock settings.

#### OSD Setup

The On-Screen Display appearance and the position/duration of the service banner information can be customised.

- 1 Press **◀/▶** to select "System Setup".
- 2 Press **OK**.

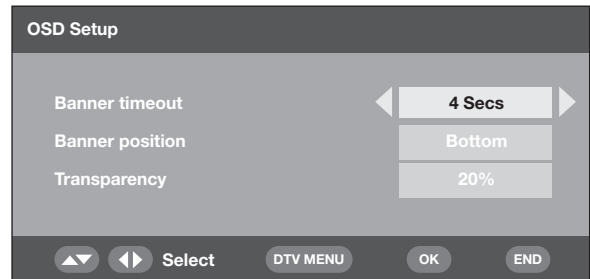

- 3 Press **▲/▼** to select the desired item.
- 4 Press **◀/▶** to select the desired parameter, and then press **OK**.
- 5 A confirmation message displays. Press **◀/▶** to select "Yes", and then press **OK** to save the change.

OSD Setup items	Selectable items	Description
Banner timeout	1 Sec/2 Secs/... 7 Secs/None	Select how long the service banner information appears on screen.
Banner position	Top/Bottom	Select whether the service banner information appears on top or bottom of the screen.
Transparency	None /10% /20%/...50%	Select the desired level of On-Screen Display transparency.

## DTV menu operations

### Child Lock

This function allows TV and Radio services to be restricted. It prevents children from watching violent or sexual scenes that may be harmful.

- 1 Press ◀/▶ to select "System Setup".
- 2 Press ▲/▼ to select "Child Lock", and then press **OK**.
- 3 If you have already set the PIN, enter it here. If not, enter the factory preset PIN "1234".
- 4 Press ◀/▶ to select the desired age/rating (4 ...18/Universal/Parental/X-rated/None), and then press **OK**.

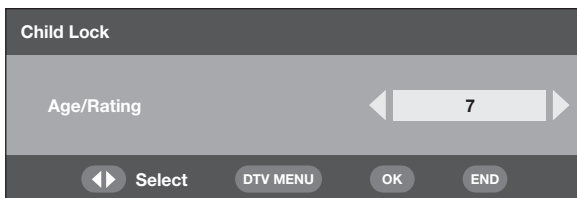

#### NOTE

- "Universal" and "Parental" are the ratings used exclusively in France.
- "X-rated" is the rating used exclusively in Spain.
- For details about ratings see page 35.

### Accessories

Check the version information of the digital module and allow it to be upgraded (when available).

### Software Version

- 1 Press ◀/▶ to select "Accessories".
- 2 Press **OK**.
  - The software version is displayed.

### Software Upgrade

The software for controlling the built-in DTV decoder can be upgraded when necessary. In Great Britain this can be achieved via an Over Air Download.

#### Preparation

Confirm and make a note of the current software version number as in step 2 of **Software Version**.

#### Manual upgrade

- 1 Press ◀/▶ to select "Accessories".
- 2 Press ▲/▼ to select "Software Upgrade", and then press **OK**. The TV checks all carriers if there is a new software available for upgrade.
  - ① **If upgrade via Over Air Download is available at the time:**

A confirmation message appears asking you to accept the upgrade or not.  
To download now, press ◀/▶ to select "Yes", and then press **OK**. After the upgrade is completed, the TV restarts automatically with the new software version installed.  
To postpone the download, press ◀/▶ to select "No", and then press **OK**. Enter the download time for more convenient time as instructed.  
The software upgrade will not be carried out if there is no new software available at the specified download time.
  - ② **If upgrade via Over Air Download is NOT available at the time:**

A message tells you that there is no software available to be downloaded.
- 3 Check the new software version number to confirm the successful upgrade.

#### Auto upgrade

- 1 When you tune to the service that provides the upgrade via Over Air Download, a confirmation message displays.
- 2 Follow the screen prompts.
- 3 Check the new software version number to confirm the successful upgrade.

#### NOTE

- To scan all carriers for upgrade availability, perform the manual upgrade.
- The software upgrade may take about 30 minutes, but may take longer (up to 1 hour) depending on the signal status. While updating, you cannot switch to TV or external input mode or enter standby mode using ⏻ | on the remote control unit.

#### CAUTION

- **Do not cut off the power to the TV in any way when the software upgrade is in progress, as this may cause the upgrade to fail. If problem arises ask a qualified service personnel before the software upgrade period expires.**

### Common Interface

Check the detailed information on the Common Interface module card in use.

- 1 Press **OK** while the cursor is on “Common Interface”.

- The CI module name is displayed.

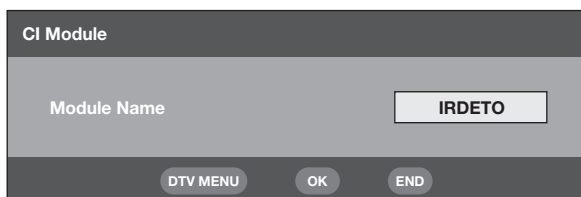

- 2 Press **OK** to access the CI menu.
  - Detailed information on the CI card in use is displayed.
- 3 Press **▲/▼** to select the item, and then press **OK**.
  - Detailed information on the selected item is displayed.

### Inserting a CA card

A single DVB Common Interface (CI) will be implemented to allow adoption of a Conditional Access (CA) system by means of a plug-in CA module. Scrambled Broadcasting service can be routed via the CA system.

If the CA system on the CI module requires a smart-card reader, this reader shall be part of the CI module. When the compatible CA card is inserted, you can view the programme without any operations.

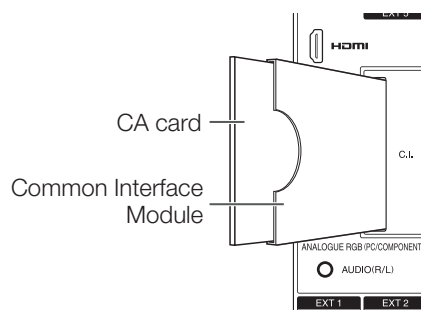

When the compatible card is not inserted:

- ① Select the programme which needs the compatible CA card.
  - The caution screen appears.
- ② Insert the compatible CA card.
  - The caution screen disappears and you can view the programme.

CA system supported by

Crypto Works  
Aston CAM  
VIAccess  
Nagra Vision  
Irdeto  
MR CAM

#### NOTE

- To view paid TV broadcasting, you need to make a contract with a service provider. Please contact a service provider for details.
- The Common Interface Module and the CA card are neither supplied nor optional accessories.

### Supplying power to the antenna

You may choose to supply power through the antenna terminal. (Page 4)

#### NOTE

- This function is enabled using the Analogue Menu. See page 16 for details.

## About EPG

With the Electronic Programme Guide (EPG), you can check the schedule of DTV and Radio events, view detailed information about them, tune to an event currently on-air and set a timer for future events.

### General EPG screen

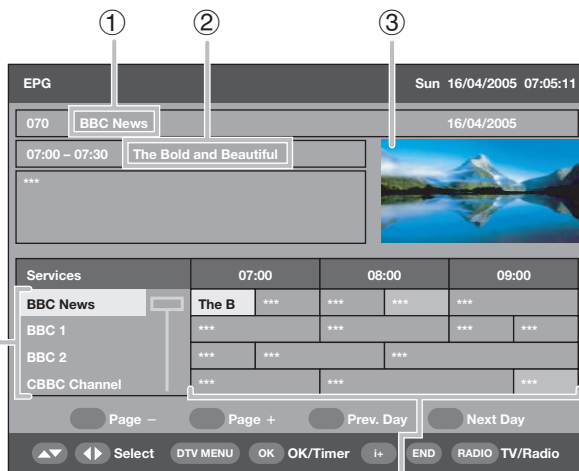

- ① **Service name**
- ② **Event name**
- ③ **Picture window**
- ④ **Service list**
  - Shows the list of all services currently available. As you scroll down the list, the rows in the Event name list on the right will be refreshed correspondingly.
- ⑤ **Event name list**
  - Shows the names of current events in a grid of rows and columns. You can check scheduled event information up to several days ahead, depending on conditions.

## Using the EPG

- 1 Press **EPG**.
  - Pressing **RADIO** will switch between DTV and Radio mode.
- 2 Press **▲/▼/◀/▶** to access the desired service or event.
  - The image shown in the picture window changes.

**In the Service list:**

  - ① Press **▲/▼** to scroll the page up/down. Or,
  - ② Press **RED** (Page -) or **GREEN** (Page +) to skip to the previous/next page in one step.

**In the Event name list:**

  - ① Press **◀/▶** to scroll the page left/right. Or,
  - ② Press **YELLOW** (Prev. Day) or **BLUE** (Next Day) to skip to the previous/next day in one step.

- 3 To watch an event currently on-air, press **OK** (OK/Timer).
  - The TV will show the image in full screen.
  - Selecting an event that has not yet started will activate the EPG Timer mode instead.

### NOTE

- Pressing **i+** opens the EPG Description screen that provides more information about the selected event. Press **i+** or **END** to exit.

## Using the EPG Timer

When the Timer is set, the TV automatically tunes to a preset TV event when its on-air time begins.

- 1 Press **EPG**.
- 2 Press **▲/▼/◀/▶** to select the desired event to be preset from the Event name list, and then press **OK** (OK/Timer).
  - Select an event not yet started.
- 3 Press **RED** (Timer Mode), and then press **▲/▼** to select the desired parameter ("Once", "Daily", "Weekly", or "Monthly"), and then press **OK**.
  - Once set, the preset event is indicated with an orange background in the EPG event name list.

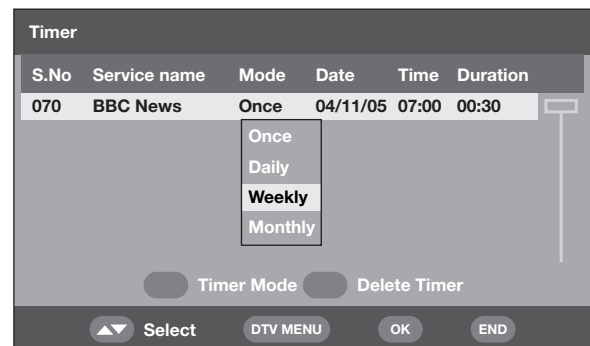

### NOTE

- If using this function for recording, make sure to set the timer of your recording equipment as well.
- Do not switch channels while recording using this function.
- This function cannot be set for locked services or when Child Lock applies. (Pages 25 and 28)
- Up to 8 events can be preset using the Timer function.
- If the TV is in standby mode when the preset on-air time nears, it will output signals for recording without image displayed on the screen.
- If you are watching another event, an alarm message displays on the screen a few seconds before the preset time.
- To cancel the preset, select the event to delete, press **GREEN** (Delete Timer), press **◀/▶** to select "Yes", and then press **OK**.
- An alert message displays when the preset events overlap one another.
- The TV power may not come on for several seconds if you preset an event using the EPG Timer and if the power to the TV is cut off.
- Once you preset an event using EPG Timer, in DTV, and then press **⏻** on the remote control to enter the standby mode, the power consumption will be higher than normal (about 23W) until the programmed event is broadcast. When pressing **⏻** on the TV to turn off the power, the power consumption will be same as normal standby consumption (about 2.4W: LC-37XD1E/2.3W: LC-42XD1E), and the EPG Timer will not be in operation.



## DTV menu operations

### Using the ESG

The Electronic Service Guide (ESG) is a simplified version of EPG, giving you only essential information of current events for faster access.

- 1 Press **ESG**.
  - The ESG screen displays.

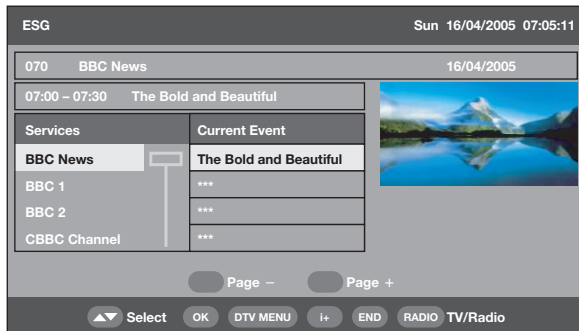

- 2 Press **▲/▼** to select a desired service, and then press **OK**.
  - The TV will show the image in full screen.

#### NOTE

- Basic operation procedures are similar to EPG operations.
- ESG does not provide information about future events, or access to Timer function.

### Using the digital programme list

Select services by using the Programme List instead of using **0** - **9** numeric buttons or **P** (▼/▲).

- 1 Press **LIST** or **OK** when no other menu screen is displayed. (Except external input.)

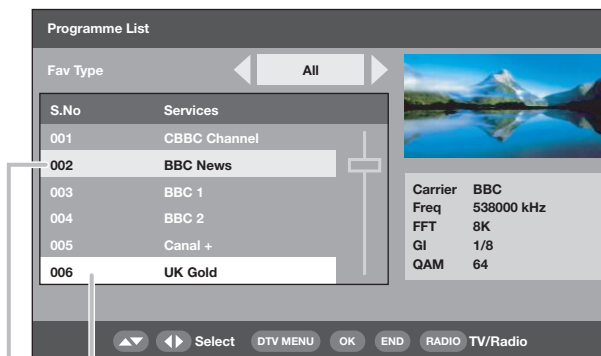

Currently tuned service

Service shown in picture window

- 2 The screen shows the service list in either TV or Radio mode sorted by favourite type (All, Fav 1 - 4) as configured in page 25.
- 3 Press **▲/▼** to select the desired service, and then press **OK**.
  - The image shown in the picture window changes.
- 4 Press **END** to exit the Programme List to watch the image in full screen.

### Viewing a service banner

A service banner shows event names, start/end time of event, and other useful information.

- 1 Press **i+**.

#### Service banner

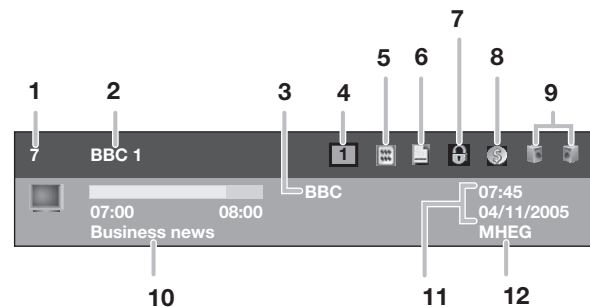

- 1 **Logical channel number**
- 2 **Service name**
- 3 **Carrier name**
- 4 **Favourite type**
- 5 **Teletext available**
- 6 **Subtitle available**
- 7 **Lock status**
- 8 **Scrambled service**
- 9 **Multi audio status**
- 10 **Current event name**
- 11 **Current date and time**
- 12 **MHEG5 service available**

- 2 To display more detailed information, press **i+** again.

- You can verify the signal strength and quality of the selected service here.

## DTV menu operations

### Using the multi audio function

Change the audio mode and language for the currently viewed service.

- 1 Press  $\nabla/\odot$  when no other menu screen is displayed.

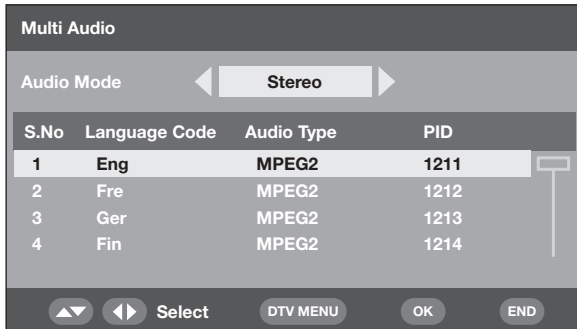

- 2 Press  $\leftarrow/\rightarrow$  to select the desired audio mode (Left, Right, L+R, Stereo), and then press  $\nabla$  to move down.
- 3 Press  $\blacktriangle/\blacktriangledown$  to select the desired language available for the service, and then press **OK**.

#### NOTE

- Once you tune to another service or the power is turned off, the setting returns to the parameter set in the Language menu. (Page 24)

### Displaying subtitles

Set the desired language for the subtitle display and enable/disable the subtitle display.

- 1 Press  $\text{...}$  when no other menu screen is displayed.

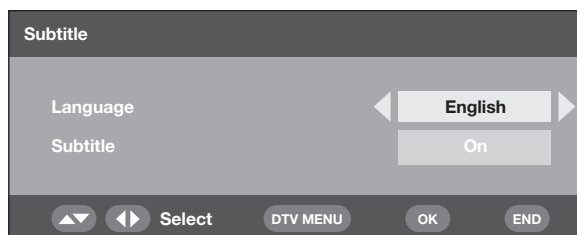

- 2 Press  $\blacktriangle/\blacktriangledown$  to select "Language",  $\leftarrow/\rightarrow$  to select the desired language available in the stream, and then press  $\nabla$ .
- 3 Select "Subtitle", press  $\leftarrow/\rightarrow$  to select "On" or "Off", and then press **OK**.
  - A confirmation message displays.
- 4 Press  $\leftarrow/\rightarrow$  to select "Yes", and then press **OK**.

#### NOTE

- When "Subtitle" is set to "On", the TV will automatically start subtitle presentation if tuned to a programme containing subtitle data.
- This function deactivates each time you turn off the TV.
- When you press  $\text{...}$  while watching DTV broadcasts, the message "No subtitle" may appear instead of the Subtitle OSD screen as mentioned. (This happens depending on the type of programme and happens even when the TV is actually receiving the subtitle data.)  
In this case, press  $\text{...}$  first to activate the teletext mode, then press  $\text{...}$ .

### Using the MHEG5 application (UK only)

Some services bring you programmes with the MHEG5 (Multimedia and Hypermedia Expert Group) application encoded, letting you experience DTV interactively. When provided, the MHEG5 application will start when you press  $\text{...}$ .

#### Sample MHEG5 screen







#### NOTE

- When "Subtitle" is set to "On", and the TV is tuned to a service containing both MHEG5 and subtitle data, the subtitle takes priority and subtitle presentation starts automatically. In this case press  $\text{...}$  to start the MHEG5 presentation.

# Appendix

## Troubleshooting

Problem	Possible Solution
<ul style="list-style-type: none"> <li>No power.</li> </ul>	<ul style="list-style-type: none"> <li>Check if you pressed  on the remote control unit. If the indicator on the TV lights up red, press .</li> <li>Is the AC cord disconnected?</li> <li>Check if you pressed  on the TV.</li> </ul>
<ul style="list-style-type: none"> <li>Unit cannot be operated.</li> </ul>	<ul style="list-style-type: none"> <li>External influences such as lightning, static electricity, etc., may cause improper operation. In this case, operate the unit after first turning the power off, or unplugging the AC cord and re-plugging it in after 1 or 2 minutes.</li> </ul>
<ul style="list-style-type: none"> <li>Remote control unit does not operate.</li> </ul>	<ul style="list-style-type: none"> <li>Are batteries inserted with polarity (+, -) aligned?</li> <li>Are batteries worn out? (Replace with new batteries.)</li> <li>Are you using it under strong or fluorescent lighting?</li> <li>Is a fluorescent light illuminated to remote control sensor?</li> </ul>
<ul style="list-style-type: none"> <li>Picture is cut off.</li> </ul>	<ul style="list-style-type: none"> <li>Is the image position correct? (Page 18)</li> <li>Are screen mode adjustments (Auto format) such as picture size made correctly? (Pages 17 and 20)</li> </ul>
<ul style="list-style-type: none"> <li>Strange colour, light colour, or dark, or colour misalignment.</li> </ul>	<ul style="list-style-type: none"> <li>Adjust the picture tone. (Page 13)</li> <li>Is the room too bright? The picture may look dark in a room that is too bright.</li> <li>Check the colour system setting. (Pages 16 and 17)</li> <li>Check the HDMI setup setting. (Page 15)</li> </ul>
<ul style="list-style-type: none"> <li>Power is suddenly turned off.</li> </ul>	<ul style="list-style-type: none"> <li>The unit's internal temperature has increased. Remove any objects blocking vent or clean.</li> <li>Is sleep timer set? Press <b>SLEEP</b> on the remote control unit until it sets to off.</li> <li>Is "No signal off" activated? (Page 18)</li> </ul>
<ul style="list-style-type: none"> <li>No picture.</li> </ul>	<ul style="list-style-type: none"> <li>Is connection to other components correct? (Pages 10 and 11)</li> <li>Is input signal type selected correctly after connection? (Page 15)</li> <li>Is the correct input source selected? (Page 19)</li> <li>Is non-compatible signal being input? (Page 34)</li> <li>Is picture adjustment correct? (Page 13)</li> <li>Is the antenna connected properly? (Page 4)</li> </ul>
<ul style="list-style-type: none"> <li>No sound.</li> </ul>	<ul style="list-style-type: none"> <li>Is the volume too low?</li> <li>Make sure that headphones are not connected.</li> <li>Check if you pressed  on the remote control unit.</li> </ul>

### Cautions regarding use in high and low temperature environments

- When the unit is used in a low temperature space (e.g. room, office), the picture may leave trails or appear slightly delayed. This is not a malfunction, and the unit will recover when the temperature returns to normal.
- Do not leave the unit in a hot or cold location. Also, do not leave the unit in a location exposed to direct sunlight or near a heater, as this may cause the cabinet to deform and the LCD panel to malfunction.  
Storage temperature: -20°C to +60°C.

### IMPORTANT NOTE ON RESETTING THE PIN

We suggest that you remove the following instruction from the operation manual to prevent children from reading it. As this operation manual is multilingual, we also suggest the same with each language. Keep it in a safe space for future reference.



- Enter "3001" when PIN entry is required.
  - This operation cannot be performed from the DTV menu screen.
- Restore the current PIN under "Change PIN" (TV menu > Setup > Child lock).

## Appendix

### PC compatibility chart

Resolution		Horizontal Frequency	Vertical Frequency	VESA Standard
VGA	640 × 480	31.5 kHz	60 Hz	✓
SVGA	800 × 600	37.9 kHz	60 Hz	✓
XGA	1024 × 768	48.4 kHz	60 Hz	✓
WXGA	1360 × 768	47.7 kHz	60 Hz	✓
SXGA	1280 × 1024	64.0 kHz	60 Hz	✓

VGA, SVGA, XGA, WXGA and SXGA are registered trademarks of International Business Machines Co., Inc.

#### NOTE

- This TV has only limited PC compatibility, correct operation can only be guaranteed if the video card conforms exactly to the VESA 60Hz standard. Any variations from this standard will result in picture distortions.

### RS-232C port specifications

#### PC Control of the TV

- When a program is set, the TV can be controlled from the PC using the RS-232C terminal. The input signal (PC/video) can be selected, the volume can be adjusted and various other adjustments and settings can be made, enabling automatic programmed playing.
- Attach an RS-232C cable cross-type (commercially available) to a 9 pin D-sub/MINI-DIN (optional: AN-A1RS) for the connections.

#### NOTE

- This operation system should be used by a person who is accustomed to using PCs.

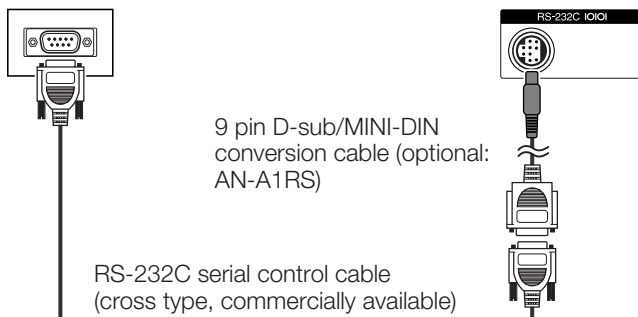

#### Communication conditions

Set the RS-232C communications settings on the PC to match the TV's communications conditions. The TV's communications settings are as follows:

<b>Baud rate:</b>	9,600 bps
<b>Data length:</b>	8 bits
<b>Parity bit:</b>	None
<b>Stop bit:</b>	1 bit
<b>Flow control:</b>	None

#### Communication procedure

Send the control commands from the PC via the RS-232C connector.

The TV operates according to the received command and sends a response message to the PC.

Do not send multiple commands at the same time. Wait until the PC receives the OK response before sending the next command.

Make sure to send "A" with the carriage return and confirm that "ERR" returns before operating.

#### Command format

Eight ASCII codes + CR

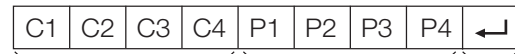

Command 4-digits

Parameter 4-digits

Return code

Command 4-digits: Command. The text of four characters.

Parameter 4-digits: Parameter 0 - 9, blank, ?

#### Parameter

Input the parameter values, aligning left, and fill with blank(s) for the remainder. (Be sure that four values are input for the parameter.)

When the input parameter is not within an adjustable range, "ERR" returns. (Refer to "Response code format".)

0			
---	--	--	--

0	0	0	9
---	---	---	---

-	3	0	
---	---	---	--

1	0	0	
---	---	---	--

0	0	5	5
---	---	---	---

When "?" is input for some commands, the present setting value responds.

?			
---	--	--	--

?	?	?	?
---	---	---	---

#### Response code format

Normal response

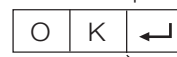

Return code (0DH)

Problem response (communication error or incorrect command)



Return code (0DH)

After sending the return code (0DH), make sure to send line feed (0AH) as well.

# Appendix

## Commands

CONTROL ITEM	COMMAND	PARAMETER	CONTROL CONTENTS
POWER SETTING	P O W R	0 _ _ _	POWER OFF
INPUT SELECTION A	I T V D	_ _ _ _	TV (CHANNEL FIXED)
	I D T V	_ _ _ _	DTV (CHANNEL FIXED)
	I A V D	* _ _ _	EXT1 - 6 (1 - 6)
	I A V D	? ? ? ?	1 to 6, 0 (TV/DTV)
CHANNEL	D C C H	* * * _	TV DIRECT CHANNEL (0 - 998)
	D C C H	? ? ? ?	0 to 998
	C H U P	_ _ _ _	CHANNEL UP
	C H D W	_ _ _ _	CHANNEL DOWN
	D T V D	* * * _	DTV DIRECT CHANNEL (1 to 999)
	D T V D	? ? ? ?	1 to 999
	D T U P	_ _ _ _	DTV CHANNEL UP
	D T D W	_ _ _ _	DTV CHANNEL DOWN
INPUT SELECTION B	I N P 1	0 _ _ _	EXT1 (Y/C)
	I N P 1	1 _ _ _	EXT1 (CVBS)
	I N P 1	2 _ _ _	EXT1 (RGB)
	I N P 1	? ? ? ?	0 to 2
	I N P 2	0 _ _ _	EXT2 (Y/C)
	I N P 2	1 _ _ _	EXT2 (CVBS)
	I N P 2	? ? ? ?	0 to 1
	I N P 3	0 _ _ _	EXT3
	I N P 4	0 _ _ _	EXT4 (RGB)
	I N P 4	1 _ _ _	EXT4 (COMPONENT)
	I N P 4	? ? ? ?	0 to 1
	I N P 5	0 _ _ _	EXT5 (HDMI)
	I N P 6	0 _ _ _	EXT6 (HDMI)
	AV MODE SELECTION	A V M D	0 _ _ _
A V M D		1 _ _ _	STANDARD
A V M D		2 _ _ _	SOFT
A V M D		3 _ _ _	ECO
A V M D		4 _ _ _	DYNAMIC
A V M D		5 _ _ _	USER
VOLUME	V O L M	* * _ _	VOLUME (0 - 63)
	V O L M	? ? ? ?	0 to 63

### NOTE

- If an underbar ( \_ ) appears in the parameter column, enter a space.
- If an asterisk ( \* ) appears, enter a value in the range indicated in brackets under CONTROL CONTENTS.

CONTROL ITEM	COMMAND	PARAMETER	CONTROL CONTENTS
GEOMETRY	H P O S	* * * _	H-POSITION AV (-10 - +10) PC (0 - 80)
	H P O S	? ? ? ?	AV (-10 - +10) PC (0 - 80)
	V P O S	* * * _	V-POSITION AV (-10 - +10) PC (0 - 40)
	V P O S	? ? ? ?	AV (-10 - +10) PC (0 - 40)
	P H S E	* * * _	PHASE PC (-20 - +20)
	P H S E	? ? ? ?	PC (-20 - +20)
WIDE MODE	W I D E	0 _ _ _	WIDE MODE (Toggle)
	W I D E	1 _ _ _	FULL (SD)
	W I D E	2 _ _ _	NORMAL (SD)
	W I D E	3 _ _ _	PANORAMA (SD)
	W I D E	4 _ _ _	CINEMA 16:9 (SD)
	W I D E	5 _ _ _	CINEMA 14:9 (SD)
	W I D E	6 _ _ _	FULL (HD)
	W I D E	7 _ _ _	UNDERSCAN (HD)
	W I D E	8 _ _ _	FULL (PC)
	W I D E	9 _ _ _	NORMAL (PC)
MUTE	M U T E	0 _ _ _	MUTE (Toggle)
	M U T E	1 _ _ _	MUTE ON
	M U T E	2 _ _ _	MUTE OFF
	M U T E	? ? ? ?	1 to 2
SURROUND	A C S U	0 _ _ _	SURROUND (Toggle)
	A C S U	1 _ _ _	SURROUND ON
	A C S U	2 _ _ _	SURROUND OFF
	A C S U	? ? ? ?	1 to 2
AUDIO CHANGE	A C H A	_ _ _ _	SOUND SELECT (ST/Bilingual/mono)
SLEEP TIMER	O F T M	0 _ _ _	OFF
	O F T M	1 _ _ _	30 m
	O F T M	2 _ _ _	1 h 00 m
	O F T M	3 _ _ _	1 h 30 m
	O F T M	4 _ _ _	2 h 00 m
	O F T M	5 _ _ _	2 h 30 m
TEXT	O F T M	? ? ? ?	0 to 150
	T E X T	0 _ _ _	TEXT OFF
	T E X T	1 _ _ _	TEXT CHANGE
	T E X T	? ? ? ?	0 to 1
	D C P G	* * * _	DIRECT PAGE JUMP (100 - 899)
D C P G	? ? ? ?	100 to 899	

## Rating table for Child Lock

Broadcasted rating / User-adjusted rating	AGE														
	4	5	6	7	8	9	10	11	12	13	14	15	16	17	18
Universal	✓	-	-	-	-	-	-	-	-	-	-	-	-	-	-
Parental	✓	✓	✓	✓	✓	-	-	-	-	-	-	-	-	-	-
X-rated	✓	✓	✓	✓	✓	✓	✓	✓	✓	✓	✓	✓	✓	✓	✓

Broadcasted rating / User-adjusted rating	Universal	Parental	X-rated
Universal	-	-	-
Parental	✓	-	-
X-rated	✓	✓	-

## Specifications

Item		37" LCD COLOUR TV, Model: LC-37XD1E	42" LCD COLOUR TV, Model: LC-42XD1E
LCD panel		37" Advanced Super View & BLACK TFT LCD	42" Advanced Super View
Number of dots		6,220,800 dots (1920 × 1080 × 3 dots)	
Video Colour System		PAL/SECAM/NTSC 3.58/NTSC 4.43/PAL 60	
TV Function	TV-Standard	Analogue	CCIR (B/G, I, D/K, L, L')
		Digital	DVB-T (2K/8K OFDM)
	Receiving Channel	VHF/UHF	E2-E69ch, F2-F10ch, I21-I69ch, IR A-IR Jch, (Digital: E5-E69ch)
		CATV	Hyper-band, S1-S41ch
	TV-Tuning System	Auto Preset 999 ch, Auto Label, Auto Sort	
STEREO/BILINGUAL		NICAM/A2	
Brightness		450 cd/m <sup>2</sup>	
Backlight life		60,000 hours (at Backlight Standard position)	
Viewing angles		H : 176° V : 176°	
Audio amplifier		10W × 2	15W × 2
Speaker		(100 mm × 40 mm) × 2, Ø 20 mm × 2	(100 mm × 40 mm) × 4
Terminals	Rear	Antenna input	UHF/VHF 75 Ω Din type (Analogue & Digital)
		RS-232C	9 pin MINI-DIN male connector
		EXT 1	SCART (AV input, Y/C input, RGB input, TV output)
		EXT 2	SCART (AV input/monitor output, Y/C input, AV Link)
		EXT 3	S-VIDEO (Y/C input), RCA pin (AV input)
		EXT 4	Ø 3.5 mm jack (Audio input), 15 pin mini D-sub (PC/Component)
		EXT 5	HDMI, Ø 3.5 mm jack (Audio input)
		EXT 6	HDMI
		C. I. (Common Interface)	EN50221, R206001
		OUTPUT	RCA pin (Audio)
		Headphones	Ø 3.5mm jack (Audio output)
OSD language		English/German/French/Italian/Spanish/Dutch/Swedish/Portuguese/Finnish/ Turkish/Greek/Russian/Polish	
Power Requirement		AC 220-240 V, 50 Hz	
Power Consumption		215W (2.4 W Standby) (Method IEC60107)	228 W (2.3 W Standby) (Method IEC60107)
Weight		21.0 kg (Without stand), 24.5 kg (With stand)	29.5 kg (Without stand), 33.0 kg (With stand)
Operating temperature		0°C to +40°C	

- As a part of policy of continuous improvement, SHARP reserves the right to make design and specification changes for product improvement without prior notice. The performance specification figures indicated are nominal values of production units. There may be some deviations from these values in individual units.

### NOTE

- Refer to inside back cover for dimensional drawings.

## Optional accessories

The listed optional accessories are available for the LCD colour TV. Please purchase them at your nearest shop.

- Additional optional accessories may be available in near future. When purchasing, please read the newest catalogue for compatibility and check the availability.

No.	Part name		Part number
1	Wall mount bracket	LC-37XD1E	AN-37AG2
		LC-42XD1E	AN-37AG2/AN-52AG1
2	9 pin D-sub/MINI-DIN conversion cable		AN-A1RS



## A. Information on Disposal for Users (private households)



Attention: Your product is marked with this symbol. It means that used electrical and electronic products should not be mixed with general household waste. There is a separate collection system for these products.

### 1. In the European Union

Attention: If you want to dispose of this equipment, please do not use the ordinary dust bin!

Used electrical and electronic equipment must be treated separately and in accordance with legislation that requires proper treatment, recovery and recycling of used electrical and electronic equipment. Following the implementation by member states, private households within the EU states may return their used electrical and electronic equipment to designated collection facilities free of charge\*. In some countries\* your local retailer may also take back your old product free of charge if you purchase a similar new one.  
\*) Please contact your local authority for further details.

If your used electrical or electronic equipment has batteries or accumulators, please dispose of these separately beforehand according to local requirements.

By disposing of this product correctly you will help ensure that the waste undergoes the necessary treatment, recovery and recycling and thus prevent potential negative effects on the environment and human health which could otherwise arise due to inappropriate waste handling.

### 2. In other Countries outside the EU

If you wish to discard this product, please contact your local authorities and ask for the correct method of disposal.

For Switzerland: Used electrical or electronic equipment can be returned free of charge to the dealer, even if you don't purchase a new product. Further collection facilities are listed on the homepage of [www.swico.ch](http://www.swico.ch) or [www.sens.ch](http://www.sens.ch).

## B. Information on Disposal for Business Users

### 1. In the European Union

If the product is used for business purposes and you want to discard it:

Please contact your SHARP dealer who will inform you about the take-back of the product. You might be charged for the costs arising from take-back and recycling. Small products (and small amounts) might be taken back by your local collection facilities.

For Spain: Please contact the established collection system or your local authority for take-back of your used products.

### 2. In other Countries outside the EU

If you wish to discard of this product, please contact your local authorities and ask for the correct method of disposal.

# Note

---

( ): LC-37XD1E  
 [ ]: LC-42XD1E  
 ■ : LC-37XD1E  
 ■ : LC-42XD1E

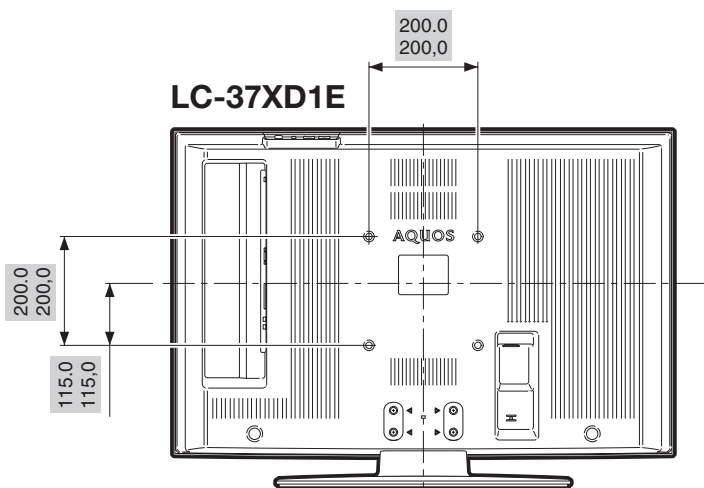
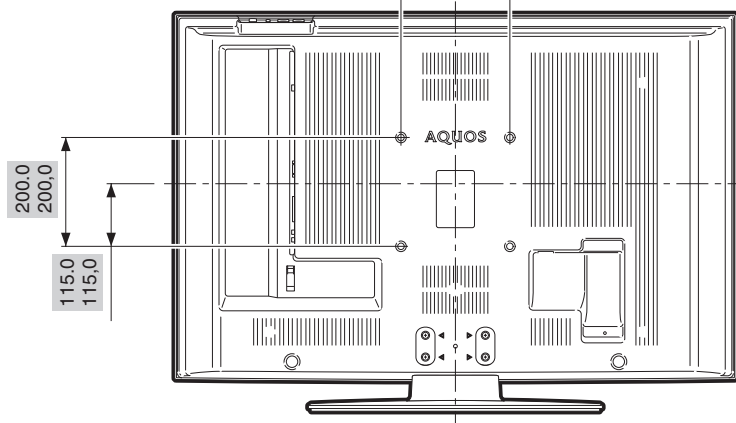
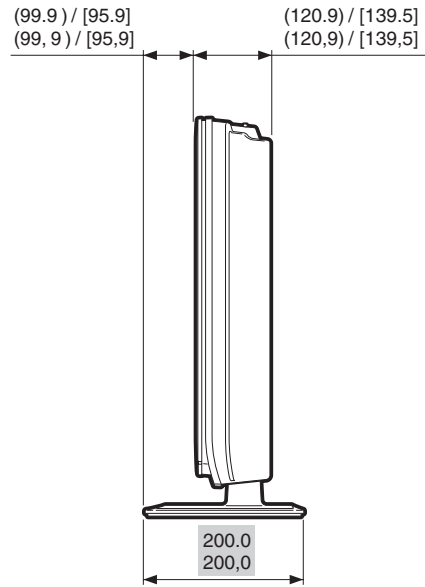
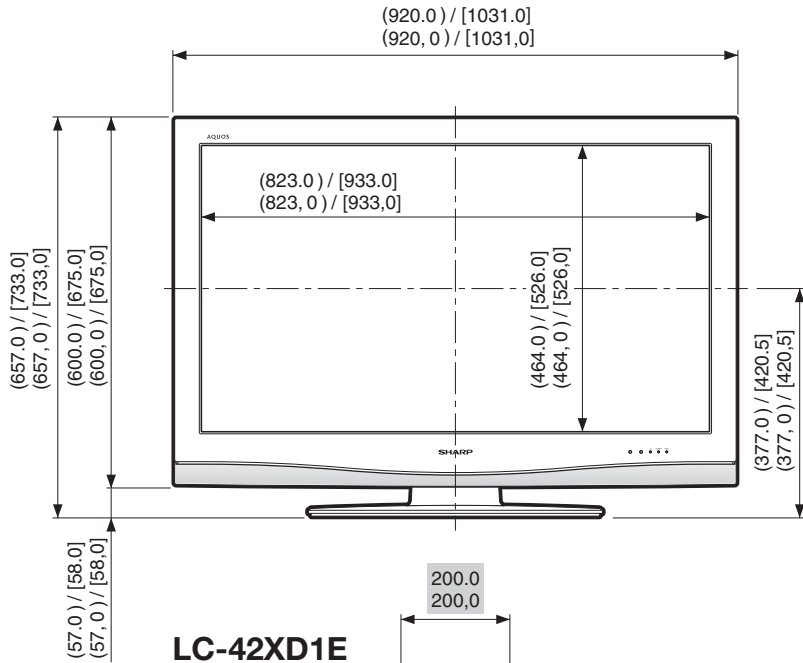
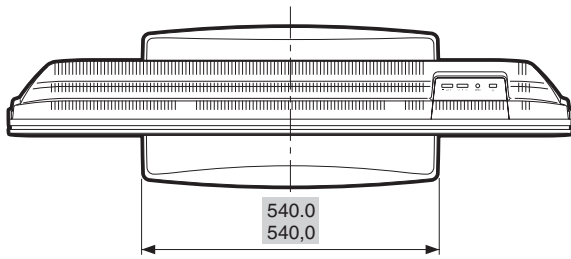

# SHARP®

SHARP CORPORATION

SHARP ELECTRÓNICA ESPAÑA S.A.

Polígono Industrial Can Sant Joan  
Calle Sena s/n  
08174 SANT CUGAT DEL VALLÉS  
BARCELONA (ESPAÑA)

Printed on environmentally friendly paper  
Auf ökologischem Papier gedruckt  
Imprimé sur papier écologique  
Stampato su carta ecologica  
Afgedrukt op ecologisch papier  
Impreso en papel ecológico



Printed in Spain  
Gedruckt in Spanien  
Imprimé en Espagne  
Stampato in Spagna  
Gedruckt in Spanje  
Impreso en España

**TINS-C723WJZZ**  
06P10-SP-NG

PIN

--	--	--	--

## Free Manuals Download Website

<http://myh66.com>

<http://usermanuals.us>

<http://www.somanuals.com>

<http://www.4manuals.cc>

<http://www.manual-lib.com>

<http://www.404manual.com>

<http://www.luxmanual.com>

<http://aubethermostatmanual.com>

Golf course search by state

<http://golfingnear.com>

Email search by domain

<http://emailbydomain.com>

Auto manuals search

<http://auto.somanuals.com>

TV manuals search

<http://tv.somanuals.com>