



OPERATING INSTRUCTIONS

---



***R-904***  
***DIGITAL A/V RECEIVER***







# Introduction

## READ THIS BEFORE OPERATING YOUR UNIT

	<b>CAUTION</b> RISK OF ELECTRIC SHOCK DO NOT OPEN	
<b>CAUTION</b> : TO REDUCE THE RISK OF ELECTRIC SHOCK, DO NOT REMOVE COVER (OR BACK). NO USER-SERVICEABLE PARTS INSIDE. REFER SERVICING TO QUALIFIED SERVICE PERSONNEL.		

	This symbol is intended to alert the user to the presence of uninsulated "dangerous voltage" within the product's enclosure that may be of sufficient magnitude to constitute a risk of electric shock to persons.
	This symbol is intended to alert the user to the presence of important operating and maintenance (servicing) instructions in the literature accompanying the appliance.

**WARNING** : TO REDUCE THE RISK OF FIRE OR ELECTRIC SHOCK, DO NOT EXPOSE THIS APPLIANCE TO RAIN OR MOISTURE.

### Caution regarding installation

**Note** : For heat dispersal, do not install this unit in a confined space such as a bookcase or similar enclosure.

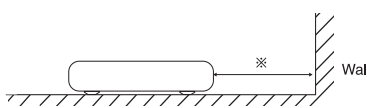
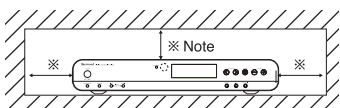

**Do not block ventilation openings or stack other equipment on the top.**

## FOR YOUR SAFETY

<b>EUROPE AUSTRALIA</b>	<b>220 V</b>	Units shipped to Australia are designed for operation on 240 V AC only. To ensure safe operation, the three-pin plug supplied must be inserted only into a standard three-pin power point which is effectively earthed through the normal household wiring. Extension cords used with the equipment must be three-core and be correctly wired to provide connection to earth. Improper extension cords are a major cause of fatalities. The fact that the equipment operates satisfactorily does not imply that the power point is earthed and that the installation is completely safe. For your safety, if in any doubt about the effective earthing of the power point, consult a qualified electrician. PAN-EUROPEAN UNIFIED VOLTAGE All units are suitable for use on supplies 220-240 V AC.
	- <b>240 V</b>	

### CAUTION

- Leave a space around the unit for sufficient ventilation.
- Avoid installation in extremely hot or cold locations, or in an area that is exposed to direct sunlight or heating equipment.
- Keep the unit free from moisture, water, and dust.
- Do not let foreign objects in the unit.
- The ventilation should not be impeded by covering the ventilation openings with items, such as newspapers, table-cloths, curtains, etc.
- No naked flame sources, such as lighted candles, should be placed on the unit.
- Please be care the environmental aspects of battery disposal.
- The unit shall not be exposed to dripping or splashing for use.
- No objects filled with liquids, such as vases, shall be placed on the unit.
- Do not let insecticides, benzene, and thinner come in contact with the set.
- Never disassemble or modify the unit in any way.
- Notes on the AC power cord and the wall outlet.
- The unit is not disconnected from the AC power source(mains) as long as it is connected to the wall outlet, even if the unit has been turned off.
- To completely disconnect this product from the mains, disconnect the plug from the wall socket outlet.
- When setting up this product, make sure that the AC outlet you are using is easily accessible.
- Disconnect the plug from the wall outlet when not using the unit for long periods of time.

### Information for Users on Collection and Disposal of Old Equipment and used Batteries



These symbols on the products, packaging, and/or accompanying documents mean that used electrical and electronic products and batteries should not be mixed with general household waste. For proper treatment, recovery and recycling of old products and used batteries, please take them to applicable collection points, in accordance with your national legislation.



By disposing of these products and batteries correctly, you will help to save valuable resources and prevent any potential negative effects on human health and the environment which could otherwise arise from inappropriate waste handling.



For more information about collection and recycling of old products and batteries, please contact your local municipality, your waste disposal service or the point of sale where you purchased the items.

**Pb**

### [Information on Disposal in other Countries outside the European Union]

These symbols are only valid in the European Union. If you wish to discard these items, please contact your local authorities or dealer and ask for the correct method of disposal.

### Note for the battery symbol (bottom two symbol examples):

The sign Pb below the symbol for batteries indicates that this batteries contains lead.



## CONTENTS

• <b>Introduction</b>	
READ THIS BEFORE OPERATING YOUR UNIT .....	2
• <b>System Connections</b> .....	4
• <b>Front Panel Controls</b> .....	10
• <b>Universal Remote Controls</b> .....	12
OPERATING COMPONENTS WITH REMOTE CONTROL .....	14
REMOTE CONTROL OPERATION RANGE .....	14
LOADING BATTERIES .....	14
USING FUNCTIONS OF REMOTE CONTROL .....	15
• <b>Operations</b>	
LISTENING TO A PROGRAM SOURCE .....	18
SURROUND SOUND .....	20
ENJOYING SURROUND SOUND .....	22
LISTENING TO RADIO BROADCASTS .....	27
LISTENING TO RDS BROADCASTS (FM ONLY) .....	29
(RDS Tuner (Regional Option for some countries in Europe, etc.))	
OTHER FUNCTIONS .....	31
ROOM2 SOURCE PLAYBACK .....	32
• <b>System Setup</b> .....	33
SETTING THE SYSTEM .....	35
SETTING THE ROOM EQ .....	36
SETTING THE SPEAKER SETUP .....	37
SETTING THE MULTI ROOM SETUP .....	41
• <b>Troubleshooting Guide</b> .....	42
• <b>Specifications</b> .....	43
• <b>Setup Code Table</b> .....	44

## System Connections

- Please be certain that this unit is unplugged from the AC outlet before making any connections.
- Since different components often have different terminal names, carefully read the operating instructions of the component connected.
- Be sure to observe the color coding when connecting audio, video and speaker cords.
- Make connections firmly and correctly. If not, it can cause loss of sound, noise or damage to the receiver.

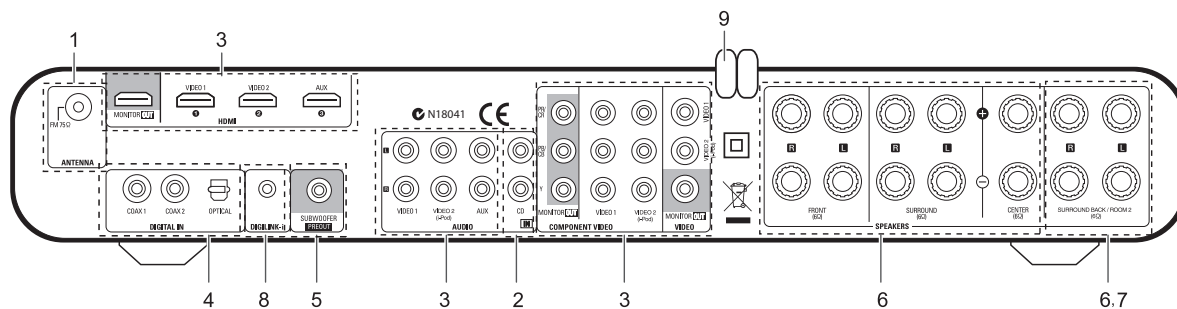

### 1. CONNECTING ANTENNAS

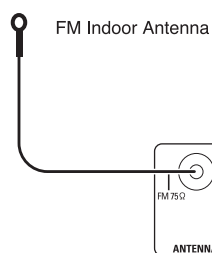

- Change the position of the FM indoor antenna until you get the best reception of your favorite FM stations.

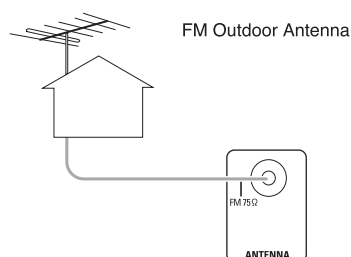

- A 75Ω outdoor FM antenna may be used to further improve the reception. Disconnect the indoor antenna before replacing it with the outdoor one.

### 2. CONNECTING AUDIO COMPONENT

- The CD IN jacks can be connected to a CD player, tape deck, etc.

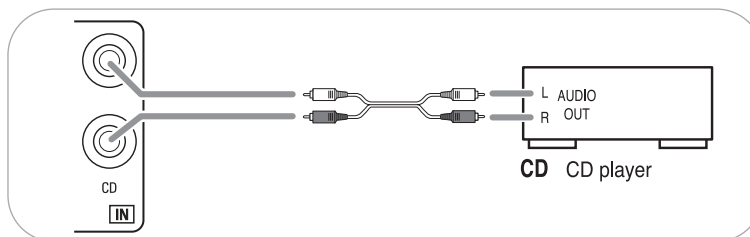



### 3. CONNECTING VIDEO COMPONENTS

- The jacks of VIDEO 1/VIDEO 2 can be connected to a BD player, DVD player, cable TV tuner, satellite system, etc.
- Connect the jacks of VIDEO 2 to the video component in the same way.
- The jacks of AUX can be connected to an additional video component without analog video jacks.  
The AUDIO jacks of AUX can be also connected to an additional audio component such as a CD player, tape deck, etc.
- There are two types of video jacks (COMPONENT, (composite) VIDEO) for analog video connections and the HDMI connectors for digital video and audio connections.  
Connect them to the corresponding video jacks according to their capability.
- For your reference, the excellence in picture quality is as follows : "HDMI" > "COMPONENT" > "(composite) VIDEO" .
- When making COMPONENT VIDEO connections, connect "Y" to "Y", "Pb/Cb" to "Cb"(or "B-Y", "Pb") and "Pr/Cr" to "Cr"(or "R-Y", "Pr").
- When viewing video program sources through MONITOR OUT jack, you must use the same type of video jacks that you did connect to video playback components such as BD player, DVD player, cable TV tuner, etc.

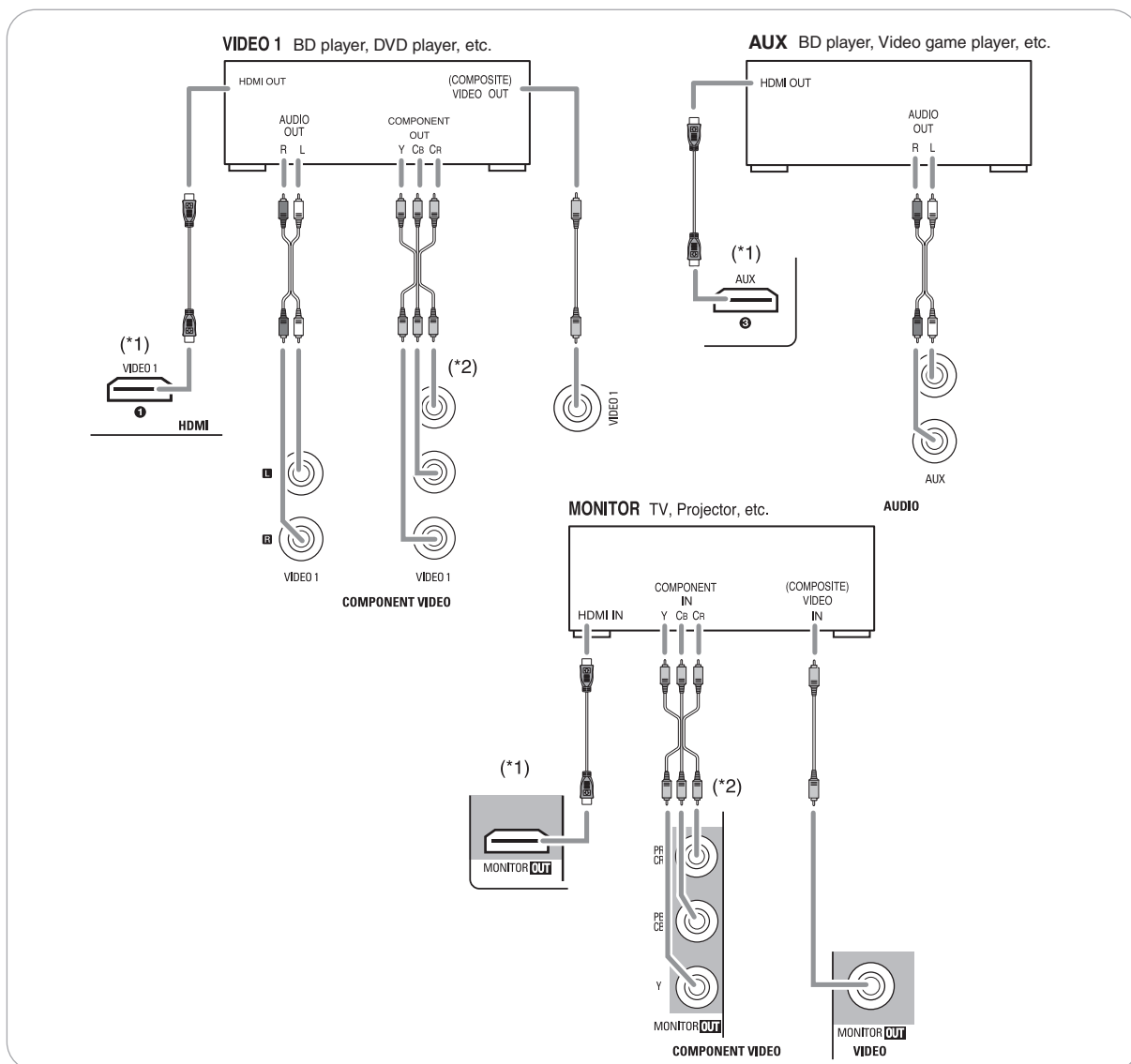

#### ■ Note :

- You can connect Apple iPod to this receiver via Sherwood iPod dock. If Sherwood iPod dock is connected to DIGILINK-i jack for system control, you should connect its video and audio jacks to the "VIDEO 2" jacks of this receiver. Because, when you control your iPod with the unit's remote control, the VIDEO 2/iPod is automatically selected as an input source and the corresponding operation is performed.

**Continued****■ HDMI (High Definition Multimedia Interface) connection : (\*1)**

- You can connect the source component (BD player, etc.) to the display component (TV, projector, etc.) through this receiver with using a commercially available HDMI cord.
- The HDMI connection can carry uncompressed digital video signals and digital audio signals.
- The HDMI video stream signals (video signals) are theoretically compatible with DVI-D. When connecting to a TV monitor, etc., equipped with DVI-D connector, it is possible to connect using a commercially available HDMI-DVI converter cord. Since the HDMI-to-DVI connection cannot carry any audio signals, set the "HDMI" to "AMP" to hear the HDMI digital audio signals on this receiver. (For details, refer to the "When selecting the "HDMI (HDMI Audio Out)" on page 24.)

**■ Copyright protection system**

- This unit supports HDCP (High-bandwidth Digital Contents Protection), technology to protect copyright of digital video signals against illegal duplication. HDCP must also be supported on the components connected to this unit.
- This unit is HDMI Ver. 1.3 compatible.
- HDMI, the HDMI logo and High-Definition Multimedia Interface are trademarks or registered trademarks of HDMI licensing LLC.

**■ Notes :**

- For stable signal transfer, we recommend using HDMI cords that are a maximum of 5 meters in length.
- Among the components that support HDMI, some components can control other components via the HDMI connector. However, this unit cannot be controlled by another component via the HDMI connector.
- The audio signals from the HDMI connector (including the sampling frequency and bit length) may be limited by the component that is connected.
- The video signals will not be output properly if a component incompatible with HDCP is connected.
- If the resolutions of the video signals which are output from the MONITOR OUTs and your monitor TV are not matched, the picture is not clear, natural or displayed. In this case, change the setting of the resolution on the source component (DVD player, etc.) to one which the monitor TV can handle. (For details, refer to the operating instructions of the source component.)
- When you want to enjoy only the picture on your TV, not the sound, you should set the "HDMI" to AMP not to output the digital audio signal from the HDMI MONITOR OUT of this receiver. (For details, refer to "When selecting the "HDMI (HDMI Audio Out)" on page 24.)

**4. CONNECTING DIGITAL INs**

- The OPTICAL and the COAXIAL DIGITAL OUTs of the components that are connected to this unit can be connected to these DIGITAL INs.
- When making the COAXIAL DIGITAL connection, be sure to use a 75 Ω COAXIAL cord, not a conventional AUDIO cord.

**■ Notes :**

- Be sure to make either a OPTICAL or a COAXIAL DIGITAL connection on each component. (You don't need to do both.)
- If you connect the DIGITAL INs to your components, you should assign the DIGITAL INs correctly. (For details, refer to "When CD, AUX, VIDEO 1, VIDEO 2("V2/IPOD") is selected as an input source" on page 19.)

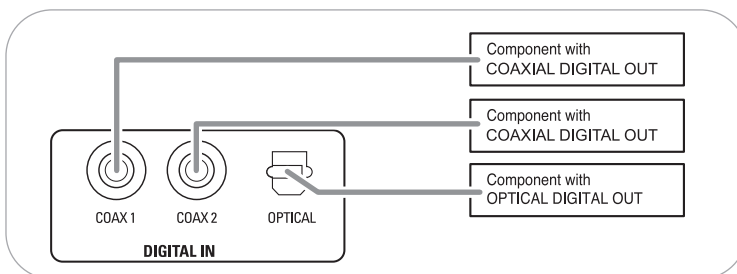
**5. CONNECTING SUBWOOFER PRE OUT**

- To emphasize the deep bass sounds, connect a powered subwoofer.

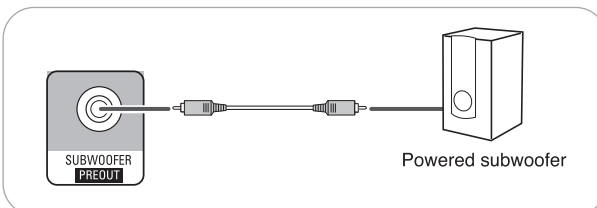

## 6. CONNECTING SPEAKERS

- Be sure to connect speakers firmly and correctly according to the channel(left and right) and the polarity (+ and -). If the connections are faulty, no sound will be heard from the speakers, and if the polarity of the speaker connection is incorrect, the sound will be unnatural and lack bass.
- When using only one surround back speaker, you should connect it to SURROUND BACK/ ROOM2 LEFT channel.
- Because this receiver cannot drive the surround back speakers and the ROOM2 speakers simultaneously, you should assign their power amplifier correctly depending on how to use them. (For details, refer to "CONNECTING ROOM2 SPEAKERS" on page 8 and "When selecting the AMP ASSIGN" on page 35.)
- For installing the speakers, refer to "Speaker placement" on page 8.
- After installing the speakers, first adjust the speaker settings according to your environment and speaker layout. (For details, refer to "SETTING THE ROOM EQ" on page 36.)

### Caution :

- Be sure to use the speakers with the impedance of 6 ohms or above.
- Do not let the bare speaker wires touch each other or any metal part of this unit. This could damage this unit and/or the speakers.
- Never touch the speaker terminals while the AC input cord is connected to the wall AC outlet. Doing so could result in electric shocks.

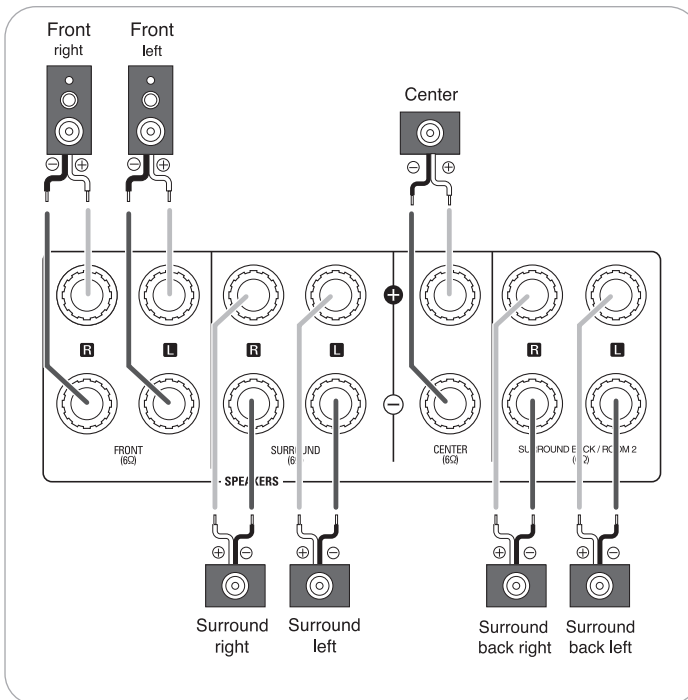

### ■ Connecting speaker wire

1. Strip away approx. 10 mm (3/8 inch) of wire insulation, then twist the wire ends tight.



2. Loosen by turning the speaker terminal counter-clockwise.



3. Insert the bare part of the wire.



4. Tighten by turning it clockwise.



## Speaker placement

Ideal speaker placement varies depending on the size of your room and the wall coverings, etc. The typical example of speaker placement and recommendations are as follows :

### ■ Front left and right speakers and center speaker

- Place the front speakers with their front surfaces as flush with TV or monitor screen as possible.
- Place the center speaker between the front left and right speakers and no further from the listening position than the front speakers.
- Place each speaker so that sound is aimed at the location of the listener's ears when at the main listening position.

### ■ Surround left and right speakers

- Place the surround speakers approximately 1 meter (40 inches) above the ear level of a seated listener on the direct left and right of them or slightly behind.

### ■ Surround back left and right speakers

- Place the surround back speakers at the back facing the front at a narrower distance than front speakers.
- When using a single surround back speaker, place it at the rear center facing the front at a slightly higher position (0 to 20 cm ) than the surround speakers.
- We recommend installing the surround back speaker(s) at a slightly downward facing angle. This effectively prevents the surround back channel signals from reflecting off the TV or screen at the front center, resulting in interference and making the sense of movement from the front to the back less sharp.

### ■ Subwoofer

- The subwoofer reproduces powerful deep bass sounds. Place a subwoofer anywhere in the front as desired.

### ■ Notes :

- When using a conventional TV, to avoid interference with the TV picture, use only magnetically shielded front left and right and center speakers.
- To obtain the best surround effects, the speakers except the subwoofer should be full range speakers.

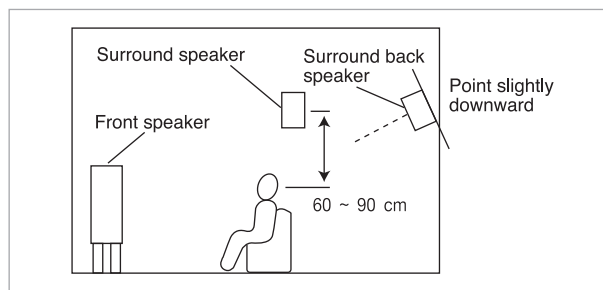
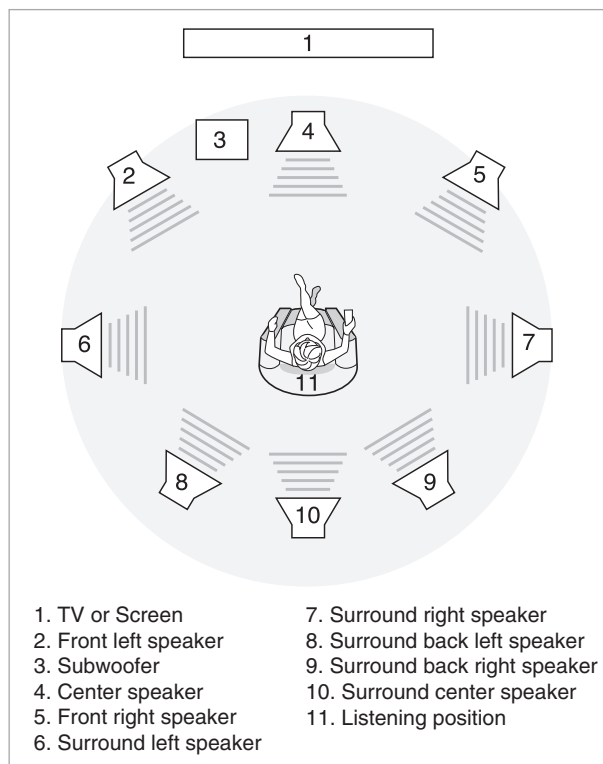

## 7. CONNECTING ROOM2 SPEAKERS

- ROOM2 playback feature allows you to play a different program source in another room as well as one source in the main room at the same time.
- For ROOM2 playback, connect the ROOM2 speakers to the SURROUND BACK/ROOM2 terminals.
- Because this receiver cannot drive the surround back speakers and the ROOM2 speakers simultaneously, you should assign their power amplifier correctly depending on how to use them. (For details, refer to "When selecting the AMP ASSIGN" on page 35.)

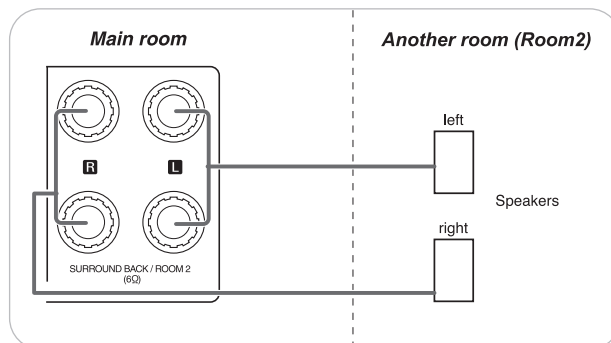





## 8. CONNECTING FOR SYSTEM CONTROL

- Connect this jack to the DIGILINK-i jack of Sherwood iPod dock that allows you to control the iPod with the unit's remote control.

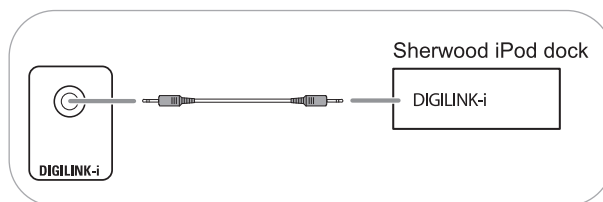

ENGLISH

## 9. AC INPUT CORD

- Plug this cord into a wall AC outlet.





# Front Panel Controls

ENGLISH

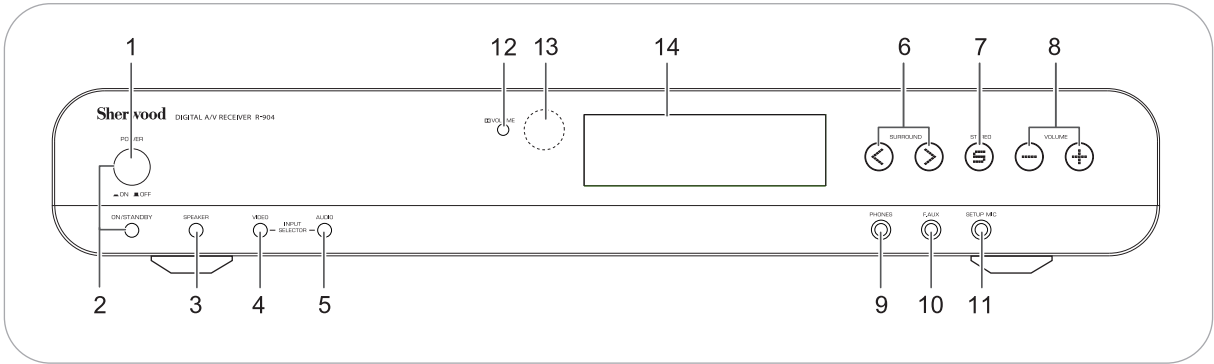

- |                                       |                             |
|---------------------------------------|-----------------------------|
| 1. POWER switch                       | 10. F. AUX jack             |
| 2. POWER ON/STANDBY button/indicator  | For details, see next page. |
| 3. SPEAKER button                     | 11. SETUP MIC jack          |
| 4. VIDEO INPUT SELECTOR button        | For details, see next page. |
| 5. AUDIO INPUT SELECTOR button        | 12. DOLBY VOLUME indicator  |
| 6. SURROUND MODE UP/DOWN(>/<) buttons | 13. REMOTE SENSOR           |
| 7. STEREO button                      | 14. FLUORESCENT DISPLAY     |
| 8. VOLUME UP/DOWN (+/-) buttons       | For details, see below.     |
| 9. HEADPHONE jack                     |                             |

## FLUORESCENT DISPLAY

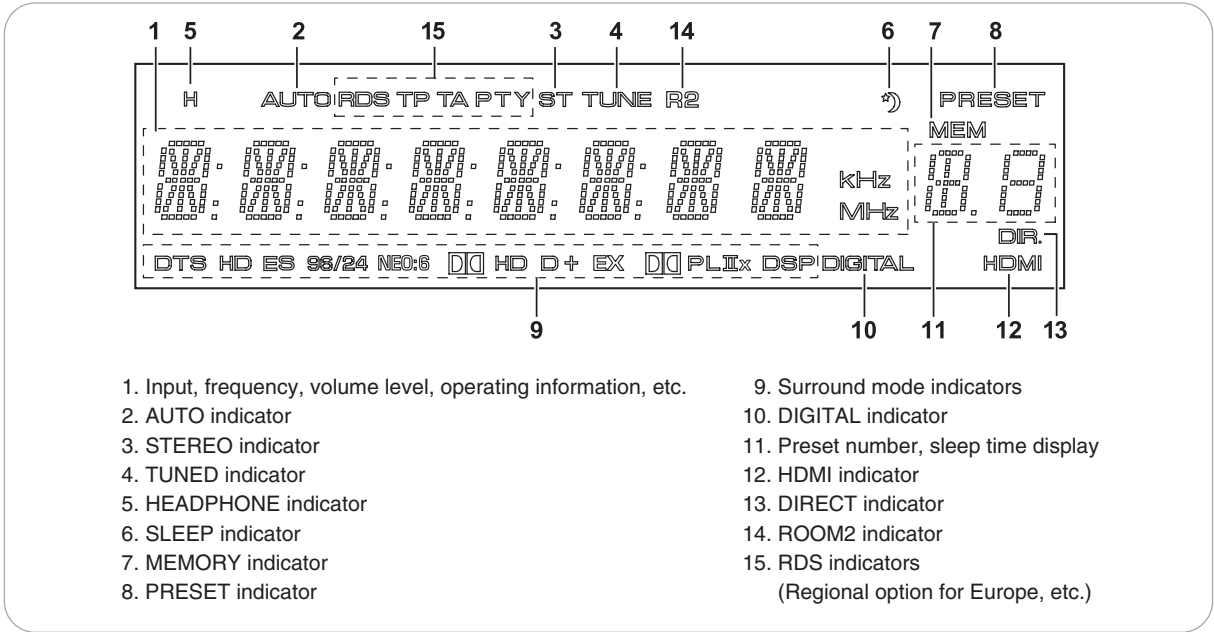

- |  |                                       |
|--|---------------------------------------|
| 1. Input, frequency, volume level, operating information, etc. | 9. Surround mode indicators           |
| 2. AUTO indicator  | 10. DIGITAL indicator                 |
| 3. STEREO indicator  | 11. Preset number, sleep time display |
| 4. TUNED indicator   | 12. HDMI indicator                    |
| 5. HEADPHONE indicator   | 13. DIRECT indicator                  |
| 6. SLEEP indicator   | 14. ROOM2 indicator                   |
| 7. MEMORY indicator  | 15. RDS indicators                    |
| 8. PRESET indicator  | (Regional option for Europe, etc.)    |



## ■ FRONT AUX JACK

- The FRONT AUX jack can be connected to additional audio components such as an MP3 player, etc.

### ■ Note :

- When connecting this jack to an MP3 player, etc., you should use the stereo mini cord, not a mono mini cord.

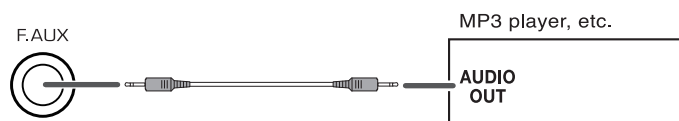

## ■ SETUP MIC JACK

- To use Room EQ setup function, connect the supplied microphone to the SETUP MIC jack. (For details, refer to "SETTING THE ROOM EQ" on page 36.)

### ■ Notes:

- Because the microphone for Room EQ setup is designed for use with this receiver, do not use a microphone other than the one supplied with this receiver.
- After you have completed the Room EQ setup procedure, disconnect the microphone.

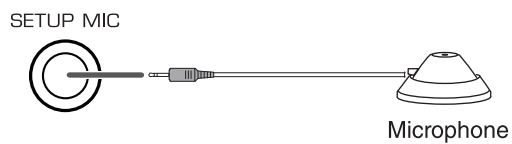

ENGLISH

# Universal Remote Controls

This universal remote control can operate not only this receiver but also most popular brands of audio and video components such as iPod docks, CD players, tape decks, TVs, BD/DVD players, satellite receivers, cable boxes, etc.

- To operate 7 components other than this receiver, you should enter the setup code for each component. (For details, refer to "USING FUNCTIONS OF REMOTE CONTROL" on page 15.)
- The numbered buttons on the remote control have different functions in different device modes. For details, refer to "FUNCTION TABLE of the NUMBERED BUTTONS" on the next page.

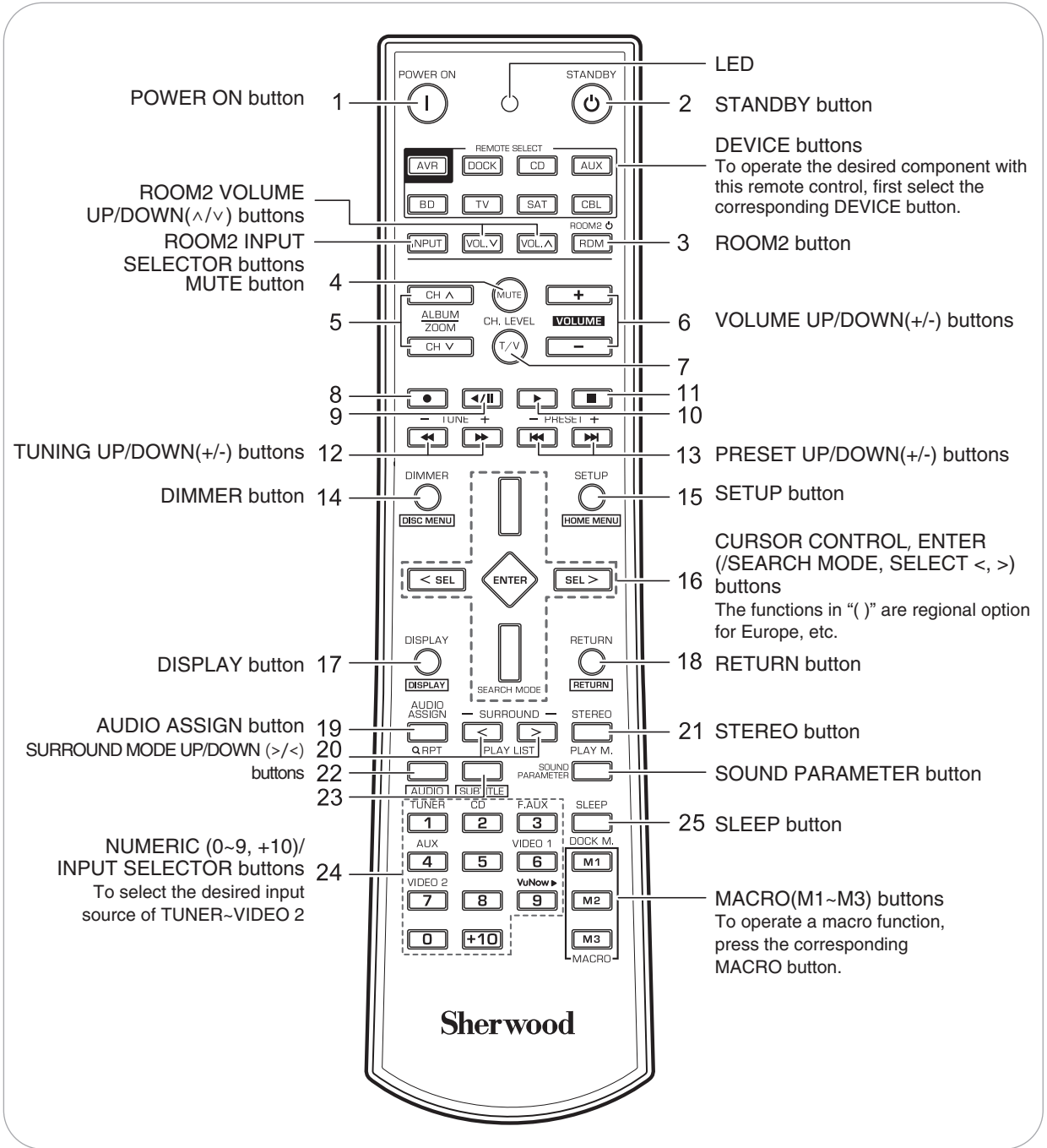

■FUNCTION TABLE of the NUMBERED BUTTONS.

Device to be controlled Button symbol	DOCK		CD	AUX	BD	TV	SAT	CBL
	(for iPod Dock)	(for VCR)	(for CD player)	(for Tape deck)	(for BD/DVD player)	(for TV)	(for Satellite receiver)	(for Cable box)
1 POWER ON 	—	POWER ON	POWER ON	—	POWER ON	POWER ON	POWER ON	POWER ON
2 STANDBY 	—	STANDBY (POWER OFF)	STANDBY (POWER OFF)	—	STANDBY (POWER OFF)	STANDBY (POWER OFF)	STANDBY (POWER OFF)	STANDBY (POWER OFF)
3 ROOM2 RDM 	RANDOM	—	—	—	—	—	—	—
4 MUTE 	—	MUTE	—	—	—	MUTE	MUTE	MUTE
5 CH ▲ ALBUM ZOOM CH ▼ 	ALBUM UP/DOWN (^/∨)	CHANNEL UP/DOWN (^/∨)	—	—	—	CHANNEL UP/DOWN (^/∨)	CHANNEL UP/DOWN (^/∨)	CHANNEL UP/DOWN (^/∨)
6 + VOLUME - 	—	VOLUME UP/DOWN (+/-)	—	—	—	VOLUME UP/DOWN (+/-)	VOLUME UP/DOWN (+/-)	VOLUME UP/DOWN (+/-)
7 CH. LEVEL T/V 	—	INPUT SELECTOR	—	—	INPUT SELECTOR	INPUT SELECTOR	INPUT SELECTOR	INPUT SELECTOR
8 	—	RECORD	—	RECORD	—	—	—	—
9 	—	PAUSE	PAUSE	PAUSE	PAUSE	—	—	—
10 	PLAY/PAUSE	PLAY	PLAY	PLAY	PLAY	—	—	—
11 	—	STOP	STOP	STOP	STOP	—	—	—
12 - TUNE + 	—	REWIND/FAST FORWARD (◀ / ▶)	—	REWIND /FAST FORWARD (◀ / ▶)	REVERSE/FORWARD SEARCH( ◀ / ▶)	—	—	—
13 - PRESET + 	REVERSE/FORWARD SKIP (◀◀ / ▶▶)	—	REVERSE/FORWARD SKIP (◀◀ / ▶▶)	—	REVERSE/FORWARD SKIP (◀◀ / ▶▶)	—	—	—
14 DIMMER DISC MENU 	MENU	—	—	—	DISC MENU	—	—	—
15 SETUP HOME MENU 	—	—	—	—	HOME MENU	—	—	—
16 CURSOR CONTROL	CURSOR UP/DOWN	—	—	—	CURSOR UP/DOWN	—	—	—
		ENTER	—	—	ENTER	—	—	—
17 DISPLAY DISPLAY 	—	—	—	—	DISPLAY	—	—	—
18 RETURN RETURN 	—	—	—	—	RETURN	—	—	—
19 AUDIO ASSIGN Q.RPT 	REPEAT	—	—	—	REPEAT	—	—	—
20 - SURROUND - PLAY LIST 	PLAY LIST UP/DOWN(↔)	—	—	—	PLAY LIST UP/DOWN(↔)	—	—	—
21 STEREO PLAY M. 	—	—	—	—	PLAY MODE	—	—	—
22 AUDIO 	—	—	—	—	AUDIO	—	—	—
23 SUBTITLE 	—	—	—	—	SUBTITLE	—	—	—
24 VnNow 0 ~ 9 +10 	—	NUMERIC	NUMERIC	—	NUMERIC	NUMERIC	NUMERIC	NUMERIC
25 SLEEP DOCK M. 	DOCK MODE	—	—	—	—	—	—	—

ENGLISH

■Notes :

- Some functions for each component may not be available or may work differently.
- Depending on other kinds of components that are available for each DEVICE button, some functions may not be available or may work differently, too.
- For details about functions, refer to the operating instructions of each component.

## OPERATING COMPONENTS WITH REMOTE CONTROL

1. Enter the setup code for each component other than this receiver. For details, refer to "Entering a setup code" on page 15.
2. Turn on the component you want to operate.
3. Press the DEVICE button on the remote control corresponding to the component you wish to operate.
4. Aim the remote control at the REMOTE SENSOR of the component you wish to control and press the button corresponding to the operation you want.

- In such a case that some components do not have the REMOTE SENSOR which receives the remote signals, this remote control cannot operate them.

## LOADING BATTERIES

- When the remote control does not operate, the old batteries should be replaced. In this case, load new batteries within several minutes after removing old batteries.
- If the batteries are removed or have been exhausted for a longer period of time, memorized contents will be cleared. Should this happen, you should memorize them again.

1. Remove the cover.

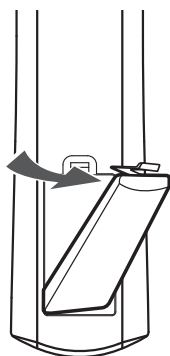

## REMOTE CONTROL OPERATION RANGE

- Use the remote control within a range of about 7 meters (23 feet) and angles of up to 30 degrees aiming at the remote sensor.

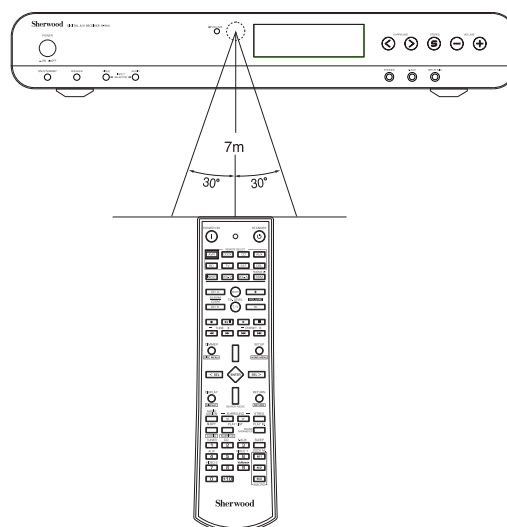

2. Load two batteries ("AAA" size, 1.5V) matching the polarity.



- Remove the batteries when they are not used for a long time.
- Do not use the rechargeable batteries (Ni-Cd type).
- Be sure to use alkaline batteries.



## USING FUNCTIONS OF REMOTE CONTROL

- This remote control can control up to 8 different components.
- Before operating audio and video components other than this receiver with using this remote control, the setup code for each component should be entered.
- For system remote control operation, "000" was stored previously in the memory of the device button "DOCK" for Sherwood iPod dock, "CD" for Sherwood CD player, "BD" for Sherwood BD/DVD player and "TV" for Sherwood TV respectively as its factory setup code. So, you don't need to enter its code for each Sherwood component except in such a case that its code does not work.

ENGLISH

### Entering a setup code

1. Turn on the component you want to operate.
2. Find the setup codes according to the type and the brand name of your component, referring to "Setup Code Table" on page 44.
3. Press and hold down both the ENTER button and the desired one of the DEVICE buttons for more than 1 seconds.

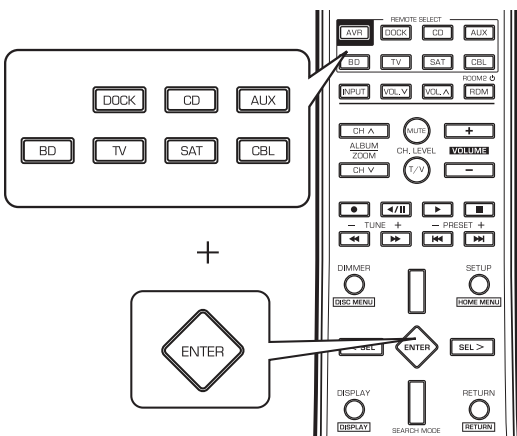

- The LED will flicker once.

#### ■ Note :

- The "AVR" button is unavailable for the audio components other than this receiver.

4. Enter a 3 digit code, aiming the remote control at the remote sensor on the component.

Example: When entering "001".

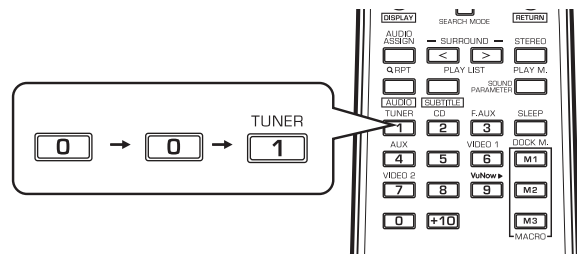

- If entering is performed successfully, the LED will flicker twice.
- To be sure that the setup code is correct, press the POWER ON (or STANDBY) button. If your component is turned off, the setup code is correct.
- When your component is not turned off, repeat the above steps 2 to 4, trying each code for your component until you find one that works.

#### ■ Notes:

- If the LED did not flicker twice, then repeat the above steps 3 to 4 and try entering the same code again.
- Manufacturers may use different setup codes for the same product category. For that reason, it is important that you check to see if the code you have entered operates as many controls as possible. If only a few functions operate, check to see if another code will work with more buttons.

5. Repeat the above steps 1 to 4 for each of your components.

## Using a punch-through function

This remote control may be programmed to operate either the AUDIO volume punch-through or the TV volume and/or TV channel punch-through in conjunction with any of the 8 components controlled by this remote control.

For example, since this receiver will likely be used as the sound system while watching TV, you may want to adjust this receiver's volume although this remote control is set to control the TV.

- When programming this remote control for the AUDIO volume punch-through, press and hold down both "AVR" button and "VOLUME +" button for more than 1 second.

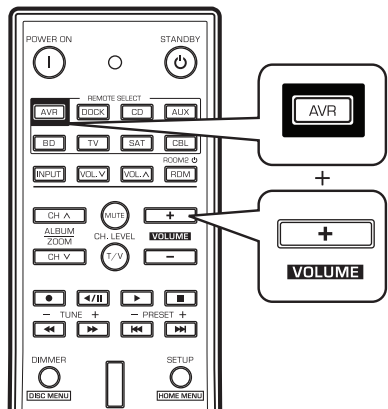

- If programming is performed successfully, the SET LED will flicker twice.
- When you want either TV volume or TV channel punch-through, press and hold down both "TV" button and either "VOLUME +" or "CH ^" button for more than 1 second.

### Note :

- If you use one of AUDIO and TV volume punch-through functions, you cannot use the other.

## Removing a punch-through function

- When removing the AUDIO volume punch-through, press and hold down both "AVR" button and "VOLUME -" button for more than 1 second.

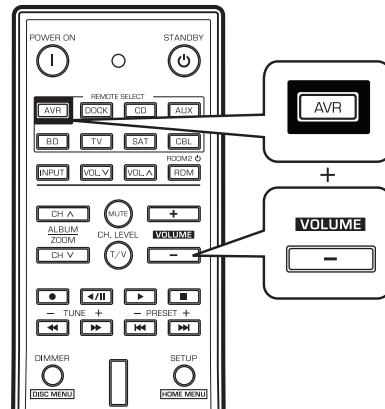

- If removing is performed successfully, the LED will flicker twice.
- When you want to remove either TV volume or TV channel punch-through, press and hold down both "TV" button and either "VOLUME -" or "CH v" button for more than 1 second.

## Removing all punch-through functions

Press and hold down both "AVR" button and "AUDIO ASSIGN" button for more than 1 second.

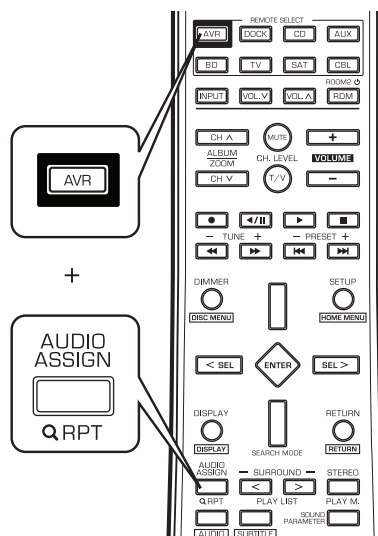

- If removing all punch-through functions is performed successfully, the LED will flicker twice.



## Programming a macro function

- The macro function enables you to program a series of button operations (up to 10) on this remote control into a single button.
- You can store up to three separate macro command sequences into “M1”, “M2” and “M3” buttons.

1. Press and hold down both “ENTER” button and one of three NUMERIC buttons (“1” ~ “3”) corresponding to “M1” ~ “M3” buttons for more than 1 second.

Example: When programming a series of button operations into “M1” button.

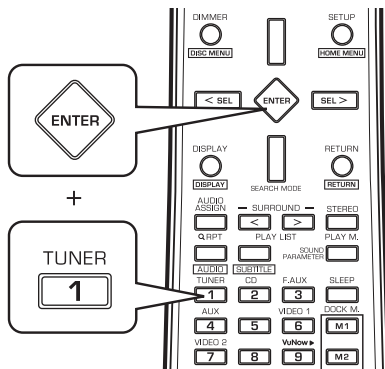

- If the macro mode is entered, the LED will flicker once.

2. Press the operation buttons you want to program in order.

### ■ Note :

You should press the corresponding DEVICE buttons before pressing each operation button.  
Example: When playing a BD on the BD player connected to VIDEO 2 jacks of this receiver.

- ①. Press “AVR” button to control this receiver.
- ②. Press “POWER ON” button to turn this receiver on.
- ③. Press “AVR” button to control this receiver.
- ④. Press “VIDEO 2(7)” button to select the desired input source.
- ⑤. Press “BD” button to control the BD player.
- ⑥. Press “POWER ON” button to turn the BD player on.
- ⑦. Press “BD” button to control the BD player.
- ⑧. Press “▶” button to start playback.

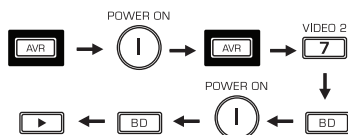

3. Press “ENTER” button.

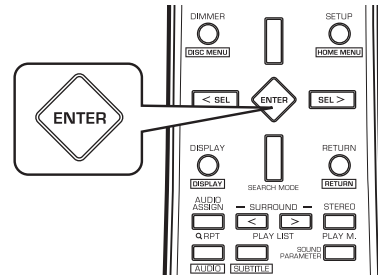

- If the programming is performed successfully, the LED will flicker twice.

### ■ To remove a macro program

- When removing a macro program, perform the above steps 1 and 3, but ignore the step 2.

### ■ To change a macro program

- When a new macro program is stored into a MACRO button with performing the above steps 1 to 3, the previous macro program is cleared from the memory of the MACRO button.

## Operating a macro function

- Aim the remote control at the REMOTE SENSORS of the components to be controlled and press the MACRO button you want.

Example: When pressing “M1” button.

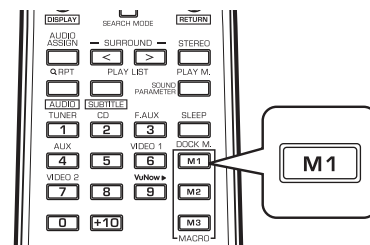

### ■ Notes:

- The codes programmed into a MACRO button will be transmitted at an interval of 0.5 seconds. However, some components may not be able to complete one operation in 0.5 seconds and may miss the next code. In this case, the macro function cannot control the corresponding components correctly.
- Be sure to use the remote control within the remote control operation range of the components.
- Depending on the operation status of the components, etc., the macro function cannot control the corresponding components correctly.

# Operations

## Notes:

- Before operating this receiver with the supplied remote control, refer to “Universal Remote Controls” on page 12 for details about operation.
- Before operating this receiver, first set this unit as desired for optimum performance, doing the system setup procedures. (For details, refer to “System Setup” on page 33.)

## LISTENING TO A PROGRAM SOURCE

### Before operation

- Enter the standby mode.
- The POWER ON/STANDBY indicator lights up amber. This means that the receiver is not disconnected from the AC mains and a small amount of current is retained to support the operation readiness.
- To switch the power off, push the POWER switch again.  
Then the power is cut off and the POWER ON/STANDBY indicator goes off.

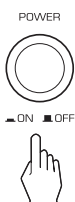

### 1. In the standby mode, turn the power on.

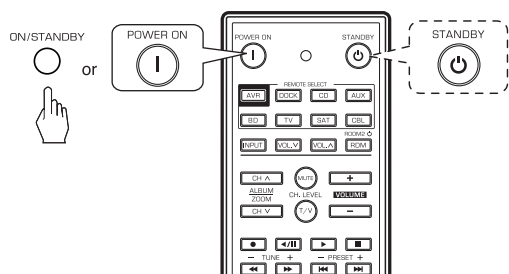

- Each time the POWER ON/STANDBY button on the front panel is pressed, the receiver is turned on to enter the operating mode (the POWER ON/STANDBY indicator lights up blue) or off to enter the standby mode (the POWER ON/STANDBY indicator lights up amber).
- On the remote control, press the POWER ON button to enter the operating mode or press the STANDBY button to enter the standby mode.

### 2. Switch the speakers on.

- Then “SPK ON” is displayed for several seconds and the sound can be heard from the speakers connected to the speaker terminals.
- When using the headphones for private listening, press the SPEAKER button again to switch the speakers off. Then “SPK OFF” is displayed for several seconds (“H” indicator lights up.)

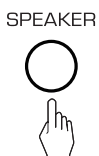

### 3. Select the desired input source.

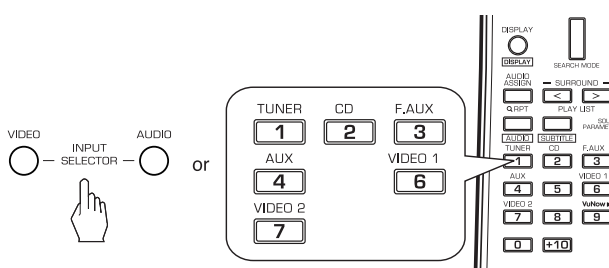

- Each time the “VIDEO” on the front panel is pressed, the input source changes as follows:

VIDEO 1 → V2/IPOD

- Each time the “AUDIO” button is pressed, the input source changes as follows:

TUNER → CD → AUX → F.AUX  
(Frequency display)

- Each time the “TUNER” button on the remote control is pressed, the band changes as follows:

FM ST → FM MONO

### When CD, AUX, VIDEO 1, VIDEO 2 (“V2/ IPOD”) is selected as an input source

4. Select the digital or analog input connected as desired.

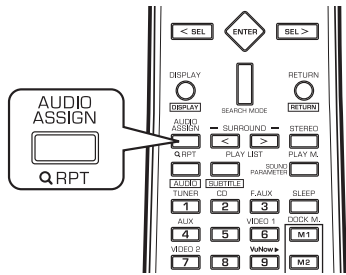

- Each time this button is pressed, the corresponding input is selected as follows :

c(oaxial)1 → c2 → o1 → H(HDMI audio)\* → A(analog)

\* : When CD is selected, the HDMI audio input cannot be selected.

**Notes:**

- When tuner, F.AUX is selected as an input source, the digital input cannot be selected.
- When the selected digital input or HDMI input is not connected, the “DIGITAL” or “HDMI” indicator flickers and the analog input is automatically selected.

5. Operate the selected component for playback.

- When playing back the program sources with surround sound, refer to “ENJOYING SURROUND SOUND” on page 22.

6. Adjust the (overall) volume.

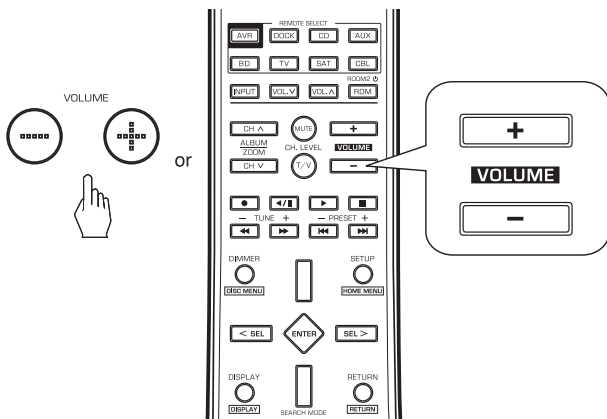

**Note:**

- For safe amplifier operation, the maximum level may vary depending on the program source, surround mode, etc.

### Muting the sound

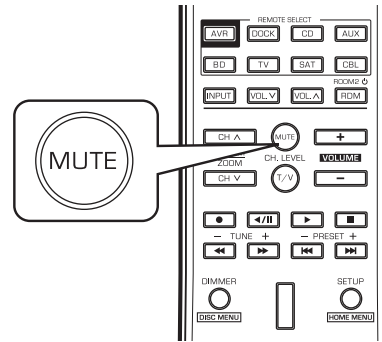

- “MUTE” is displayed.
- To resume the previous sound level, press it again.

### Listening with headphones

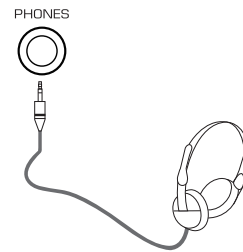

- Be sure to switch speakers off.

**Note:**

- Be careful not to set the volume too high when using headphones.

ENGLISH

## SURROUND SOUND

- This receiver incorporates a sophisticated Digital Signal Processor that allows you to create optimum sound quality and sound atmosphere in your personal Home Theater.

### Surround modes

#### ■ DTS Digital Surround

DTS Digital Surround(also called simply DTS) supports up to 5.1 discrete channels and uses less compression for high fidelity reproduction. Use it with DVDs and CDs bearing the DTS logo.

#### ■ DTS-ES™ Discrete 6.1

This is a 6.1 channel discrete digital audio format adding a surround back channel to the DTS digital surround sound. The seven totally separate audio channels provide better spatial imaging and 360 degrees sound localization, perfect for sounds that pan across the surround channels. Use it with DVDs bearing the DTS-ES logo, especially those with a DTS-ES Discrete sound track.

#### ■ DTS - ES™ Matrix 6.1

This is a 6.1 channel discrete digital audio format inserting a surround back channel to the DTS digital surround sound through matrix encoding. Use it with DVDs bearing the DTS-ES logo.

#### ■ DTS Neo:6™ surround

DTS Neo:6 is a matrix decoding technology for archieving 7.1 channel surround playback.

#### ■ DTS 96/24

This is high resolution DTS with a 96 kHz sampling rate and 24 bit resolution, providing superior fidelity. Use it with DVDs bearing the DTS 96/24 logo.

#### ■ DTS-HD High Resolution Audio

Developed for use with HDTV, including the new video disc formats Blu-ray and HD DVD, this is the latest multi-channel audio format from DTS. It supports up to 7.1 channels with 96kHz/24 bit sampling rate and signal resolution.

#### ■ DTS-HD Master Audio

Designed to take full advantage of the additional storage space offered by the new Blu-ray and HD DVD disc formats, this new DTS format offers up to 7.1 discrete channels of uncompressed digital audio with 96 kHz/24 bit sampling rate and signal resolution.

Manufactured under license under U.S. Patent #'s: 5,451,942; 5,956,674; 5,974,380; 5,978,762; 6,226,616; 6,487,535; 7,212,872; 7,333,929, 7,392,195; 7,272,567 & other U.S. and worldwide patents issued & pending.

DTS is a registered trademark and the DTS logos, Symbol, DTS-HD and DTS-HD Master Audio are trademarks of DTS, Inc.

© 1996-2008 DTS, Inc. All Rights Reserved.

#### ■ Dolby Digital

Dolby Digital is the multi-channel digital signal format developed by Dolby Laboratories. Discs bearing the Dolby Digital logo includes the recording of up to 5.1 channels of digital signals. This will put you right in the middle of the action, just like being in a movie theater or concert hall.

#### ■ Dolby Digital EX

This mode expands 5.1-channel sources for 6.1/7.1 channel playback. It's especially suited to Dolby Digital EX soundtracks that include a matrix-encoded surround back channel. The additional channel adds an extra dimension and provides an enveloping surround sound experience, perfect for rotating and fly-by sound effects.

#### ■ Dolby Digital Plus

Developed for use with HDTV, including the new video disc formats Blu-ray and HD DVD, this is the latest multichannel audio format from Dolby. It supports up to 7.1 channels with 48 kHz/24-bit sampling rate and signal resolution.

#### ■ Dolby TrueHD

Designed to take full advantage of the additional storage space offered by the new Blu-ray and HD DVD disc formats, this new Dolby format offers up to 7.1 discrete channels of lossless audio performance with 96 kHz/24 bit sampling rate and signal resolution.

#### ■ Dolby Pro Logic IIx surround

This mode expands any 2-channel source for 7.1-channel playback. It provides a very natural and seamless surround sound experience that fully envelopes the listener. As well as music and movies, video games can also benefit from the dramatic spatial effects and vivid imaging. It includes "Dolby Pro Logic IIx Movie" suited for playing movies, "Dolby Pro Logic IIx Music" suited for playing music and "Dolby Pro Logic IIx Game" suited for playing games.

#### ■ Dolby Pro Logic II surround

If you are not using any surround back speakers, Dolby Pro Logic II surround will be used instead of Dolby Pro Logic IIx surround. It includes Dolby Pro Logic II Movie, Dolby Pro Logic II Music and Dolby Pro Logic II Game like Dolby Pro Logic IIx surround.

#### ■ Dolby Pro Logic

This mode expands any 2-channel source(, including Dolby Surround source) for 4 channel (front left, center, front right and surround) playback. The surround channel is monaural, but is played through two surround speakers.

Manufactured under license from Dolby Laboratories. Dolby and the double-D symbol are registered trademarks of Dolby Laboratories.

- The following modes apply conventional 2-channel signals such as digital PCM or analog stereo signals to high performance Digital Signal Processor to recreate sound fields artificially. Select one of the 7 provided surround modes according to the program source you want to play.

#### ■ Movie

This mode provides the effect of being in a movie theater when watching a action movies with dynamic soundtracks.

#### ■ Drama

This mode is suitable for movies with lots of dialog.

#### ■ Game

This mode is suitable for video games.

#### ■ Stadium

This mode provides the expansive sound field to achieve the true stadium effect when watching baseball or soccer games.

#### ■ Classic

This mode provides the acoustic effects of a large concert hall for classical music.

#### ■ Hall

This mode provides the ambience of a concert hall for rock or pop music.

#### ■ MULTI CH Stereo

This mode is for enjoying stereo sound from all speakers.

For your reference, the sound from each channel can be reproduced according to the surround modes as follows:

Modes	Channels	FRONT L/R	CENTER	SURROUND L/R	SURROUND BACK L/R	SUBWOOFER
DTS-HD HIGH RESOLUTION AUDIO/MASTER AUDIO		O	O	O	O/—	O
DTS, DTS 96/24		O	O	O	—	O
DTS ES DISCRETE/MATRIX		O	O	O	O	O
DTS Neo: 6		O	O	O	O	—(*)
DOLBY DIGITAL PLUS / DOLBY TRUEHD		O	O	O	O/—	O
DOLBY DIGITAL		O	O	O	—	O
DOLBY DIGITAL EX		O	O	O	O	O
DOLBY PRO LOGIC IIx MOVIE/MUSIC/GAME		O	O	O	O	O
DOLBY PRO LOGIC II MOVIE/MUSIC/GAME, DOLBY PRO LOGIC		O	O	O	—	O
Other Surrounds		O	O	O	O	—(*)
STEREO		O	—	—	—	—(*)

(\*): Depending on the subwoofer setting, the sound from the subwoofer channel may be reproduced.

- Depending on the speaker settings and the number of the encoded channels, etc., the sound from the corresponding channels cannot be reproduced.(For details, refer to "SETTING THE ROOM EQ" on page 36 and "SETTING THE SPEAKER SETUP" on page 37.)

## ENJOYING SURROUND SOUND

**Notes:**

- Before surround playback, first perform the speaker setup procedure, etc. on the SETUP menu for optimum performance. (For details, refer to "SETTING THE ROOM EQ" on page 36 and "SETTING THE SPEAKER SETUP" on page 37.)

**Select the desired surround mode.**

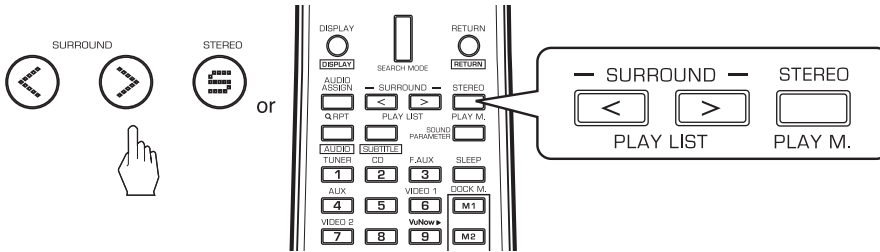

- Press the SURROUND MODE UP/DOWN (> / <) buttons to select a surround mode or press the STEREO button to select the stereo mode.
- Each time the SURROUND MODE UP/DOWN (> / <) buttons are pressed, the surround mode changes as follows :  
 Auto surround mode : The truest possible playback mode will be automatically selected according to the number of ("AUTO" indicator lights up) channels in the signal being input.

Manual surround mode : You can select the desired of different surround modes selectable for the signal being input. ("AUTO" indicator goes off)

Signal format being input	Selectable surround mode
Dolby Digital Plus sources, Dolby TrueHD sources, Dolby Digital EX 6.1 channel sources	AUTO SURROUND, corresponding DOLBY mode, STEREO
Dolby Digital 5.1 channel sources	AUTO SURROUND, <DOLBY DIGITAL EX, DOLBY D+PLIIX MUSIC>, (DOLBY D+ PLIIX MOVIE), [DOLBY DIGITAL], STEREO
Dolby Digital 2 channel sources	AUTO SURROUND, <DOLBY PLIIX MOVIE, DOLBY PLIIX MUSIC, DOLBY PLIIX GAME>, [DOLBY PLII MOVIE, DOLBY PLII MUSIC, DOLBY PLII GAME], DOLBY PRO LOGIC, STEREO
DTS-HD High Resolution Audio sources, DTS-HD Master Audio sources, DTS ES Discrete 6.1 channel sources, DTS ES Matrix 6.1 channel sources, DTS 96/24 sources	AUTO SURROUND, corresponding DTS mode, STEREO
DTS sources	AUTO SURROUND, <DTS+NEO:6, DTS+PLIIX MUSIC>, (DTS+PLIIX MOVIE), [DTS], STEREO
PCM 2 channel sources, PCM multi-channel sources, Analog stereo sources,	AUTO SURROUND, <DOLBY PLIIX MOVIE, DOLBY PLIIX MUSIC, DOLBY PLIIX GAME>, [DOLBY PLII MOVIE, DOLBY PLII MUSIC, DOLBY PLII GAME], DOLBY PRO LOGIC, MOVIE, DRAMA, GAME, STADIUM, CLASSIC, HALL, MULCH CH STEREO, STEREO

- Depending on surround back speaker setting, some surround modes can be selected or not as follows:  
 < > : Possible only when surround back speaker is not set to "NO".  
 [ ] : Possible only when surround back speaker is set to "NO".  
 ( ) : Possible only when surround back speaker is set to "X2".

**Note :**

- When the SPEAKER button is set to off, only the stereo mode can be selected.

### When adjusting the sound parameters

- You can adjust the different sound parameters for optimum surround effect.

#### 1. Press the SOUND PARAMETER button.

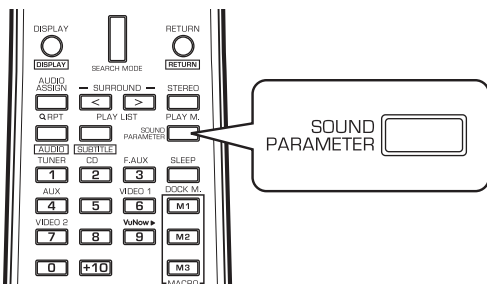

- The "EQ ~ " or ("L.SYNC ~ ", etc.) is displayed for several seconds.
- If the parameter mode disappears, press this button again.

**2.** Press the CURSOR UP/DOWN buttons to select the desired parameter.

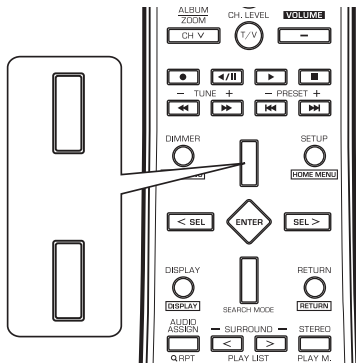

- Each time these buttons are pressed, the parameter mode changes as follows :
  - “EQ” ↔ “L.SYNC” ↔ “DM” ↔ “DRC” ↔ “LFE” ↔ “HDMI” ↔ “D.VOL” ↔ “PNRM” ↔ “DIMEN” ↔ “C.WIDTH” ↔ “A.DLY”
  - (Room EQ) (Lip-Sync) (Dual Mono) (Dynamic Range Control) (LFE level) (HDMI Audio Out) (Dolby Volume) (Panorama) (Dimension) (Center Width) (Auto Delay)

**Notes:**

- To set the “EQ” to “ON”, perform the ROOM EQ setup first. (For details, refer to “SETTING THE ROOM EQ” on page 36.)
- “C.WIDTH”, “DIMEN” and “PNRM” can be selected only while listening in Dolby Pro Logic II Music or Dolby Pro Logic IIx Music mode.
- Some parameters such as “DRC”, etc. may not be selected depending on the surround mode or program source, etc.

**3.** Press the CURSOR LEFT/RIGHT buttons to adjust the selected parameter as desired.

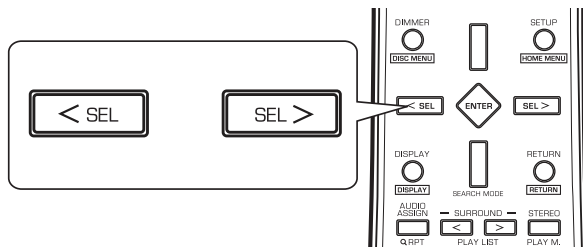

**When selecting the “EQ (Room EQ)”**

- The room EQ is a kind of room equalizer for your speakers. According to the acoustic characteristics of your room measured by the ROOM EQ setup, the room EQ automatically adjusts the frequency response of your speakers.
- If you use different brands or sizes of speakers for some channels or have a room with unique acoustic characteristics, such as walls, furniture, and the dimensions or the shape of the room, we recommend using the room EQ.

OFF : To turn off the room EQ.



ON : To adjust the frequency response of all speakers to the flattest response.

**When selecting the “L.SYNC (Lip-Sync)”**

- There may be a slight time delay between the video and audio signals in case that some video playback equipments may process the video signals later than the audio signals due to signal processing procedure, etc.. Should this happen, you can adjust the time delay of audio signals to synchronize the sound with the picture.
- The time delay can be adjusted with the range of 0.0 ~ 9.0 frames (1 sec. = 30 frames).

**When selecting the “DM (Dual Mono)”**

- Dual mono software usually is used to put two different mono soundtracks, that you can listen to together or separately, on one DVD, etc. With this setting you can choose which dual mono setting you want to listen to.
- This setting works only with dual mono encoded Dolby Digital and DTS soundtracks.

- CH 1 : Only channel 1 is heard from the front speakers.
- ↓
- CH 2 : Only channel 2 is heard.
- ↓
- CH 1+2 : Both channels are heard.

**Continued****■ When selecting the “DRC (Dynamic Range Control)”**

- This function compresses the dynamic range of previously specified parts of Dolby Digital, Dolby TrueHD, Dolby Digital Plus, DTS, DTS-HD High Resolution Audio or DTS-HD Master Audio sound track (with extremely high volume) to minimize the difference in volume between the specified and non-specified parts. This makes it easy to hear all of the sound track when watching movies at night at low levels.

→ AUTO\* : To adjust the level of dynamic range automatically.



MAX : To adjust it to “MAX” level.



MID : To adjust it to “MID” level.



→ OFF : To turn the DRC function off.

\* : Valid only when the digital signals from the Dolby TrueHD source are being input.

**■ When selecting the “LFE (LFE level)”**

- Some Dolby Digital or DTS source, etc. includes LFE (ultra low bass) signals.
- The LFE level can be adjusted as desired.

OFF : To output no sound from the LFE channel.



0 : In general, to set to 0dB (recommended value)



-10: To set to -10 dB for some early DTS software, etc.

**■ When selecting the “HDMI (HDMI Audio Out)”**

- The HDMI connection can carry uncompressed digital video signals and digital audio signals.

Depending on whether the digital audio signals input into the HDMI IN are output from the HDMI MONITOR OUT of this receiver or not, you should set the HDMI AUDIO OUT correctly.

AMP : Not to output the HDMI digital audio signals from the HDMI MONITOR OUT of this receiver, meaning these signals  
 ↑ are heard from the speakers connected to this receiver.

THRU : To output the HDMI digital audio signals from the HDMI MONITOR OUT, meaning these signals are heard from the speakers of your TV.

**■ Note :**

- When the HDMI Audio Out is set to THRU, no sound will be heard from the speakers connected to this receiver (except ROOM 2 speakers) even though any input source is selected.

**■ When selecting the “A.DLY (Auto Delay)”**

- This function automatically corrects the audio-to-video delay between components with the HDMI connection.

OFF : To turn off the Auto Delay function.



ON : To turn it on.

**■ Note :**

- This function is valid only when the connected display component supports the automatic audio/video synchronizing capability (“Lip-Sync”) for HDMI. If the automatically set delay time is unsuitable, set it to OFF and adjust the delay time manually. (For details on the auto delay feature, refer to the operating instructions of the display component.)

**■ When selecting the “C.WIDTH (Center Width)”**

- This adjusts the center image so it may be heard only from the center speaker, only from left/right speakers as a phantom image, or from all three front speakers to varying degrees.
- The control can be set in 8 steps from 0 to 7 (default value : 3)

**■ Note :**

- This control valid only when the center speaker is not set to NO.

**■ When selecting the “DIMEN (Dimension)”**

- This gradually adjusts the sound field either towards the front or towards the rear. The control can be set in 7 steps from -3 to +3 (default value : 0)

**■ When selecting the “PNRM (Panorama)”**

- This mode extends the front stereo image to include the surround speakers for an exciting “wraparound” effect with side wall imaging. Select “OFF” or “ON” (default value : OFF).



## Continued

### ■When selecting the “D.VOL (Dolby Volume)”

- Dolby Volume is an intelligent system that improves the perceived audio frequency response at lower listening levels and corrects for volume inconsistencies between sources (e.g. a jazz radio station and a DVD) and between programming (e. g. a TV show and advertisement breaks).

OFF (Default value) : To turn off the Dolby Volume function. (The DOLBY VOLUME indicator goes off.)



ON : To turn it on. (The DOLBY VOLUME indicator lights up.)

- If the Dolby Volume is set to ON, it will be automatically turns on the Volume Modeler that maintains the same perceived listening experience as the reference level experience.

### ■Note :

- If the Dolby Volume is changed to OFF, the volume level may be increased high.

### ◆When the Dolby Volume is set to ON

- Press the ENTER button to enter the Dolby Volume setup.
  - Then “LVL (Volume Leveler)” is displayed for several seconds.
- Press the CURSOR UP/DOWN buttons to select the desired parameter.
  - Each time these buttons are pressed, the parameter mode changes as follows :

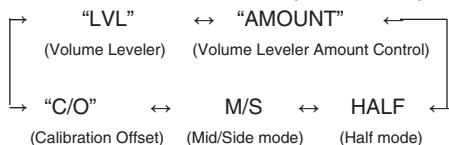

- Press the CURSOR LEFT/RIGHT buttons to adjust the selected parameter as desired.

### ◆When selecting the “LVL” (Volume Leveler)

- The Volume Leveler maintains the perceived loudness of all content for example, from different channels or input sources.

OFF : To turn off the Volume Leveler function.



ON (default value) : To turn it on.

### ■Note :

- If Volume Leveler is turned off, no level matching between sources and program material is performed. This is not the same as turning Dolby Volume off as volume related frequency response processing is still active.

### ◆When selecting the “AMOUNT” (Volume Leveler Amount Control)

The Volume Leveler Amount adjusts the amount of leveling applied by the Volume Leveler.

- The control can be set in 11 steps from 0 to 10 (default value : 9)

### ◆When selecting the “HALF” (Half mode)

If the Half mode is set to ON, the Volume Modeler does not apply volume contour gains for playback levels higher than reference level; just the volume setting, as a flat spectrum gain, is applied.

OFF (default value) : To turn off the Half mode.



ON : To turn it on.

### ◆When selecting the “M/S” (Mid/Side mode)

The Mid/Side processing can improve stability of some stereo material.

OFF (default value) : To turn off the Mid/Side mode.



ON : To turn it on.

### ◆When selecting the “C/O” (Calibration Offset)

The Calibration Offset allows you to compensate for speaker efficiencies and listening position.

- The control can be set from -15 to +15 dB (default value : 0 dB) and this should normally produce a good result when you set the speaker levels on this receiver using a SPL (Sound Pressure Level) meter.

## Adjusting the current channel level

- After adjusting each channel level with test tone, adjust the channel levels either according to the program sources or to suit your tastes. (For details, refer to "When selecting the CHANNEL LEVEL" on page 39.)

### 1. Select the desired channel.

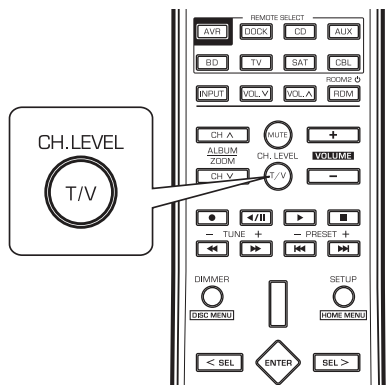

- Each time this button is pressed, the channel is selected as follows:

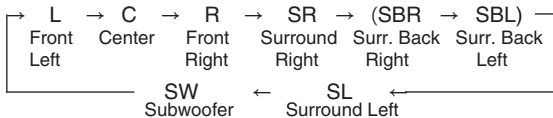

- ( ) : Possible only when the surround back speaker is set to 2ch ("x2") or 1ch ("x1")
- When the channel level disappears, press this button again.
- Depending on the speaker settings ("NO"), etc., some channels cannot be selected.

### 2. Adjust the level of the selected channel as desired.

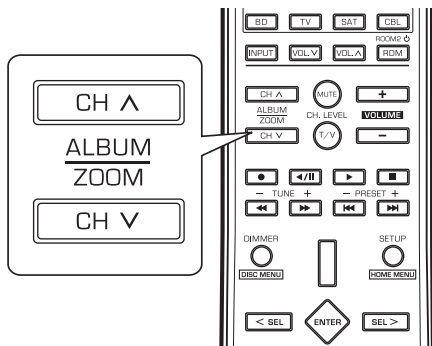

- The channel levels can be adjusted within the range of -15 ~ +15 dB.

**Note:**

- When selecting the VuNow as an input source, you cannot adjust the channel levels.

### 3. Repeat the above steps 1 and 2 to adjust each channel level.

# LISTENING TO RADIO BROADCASTS

## Auto tuning

1. Select the desired band.

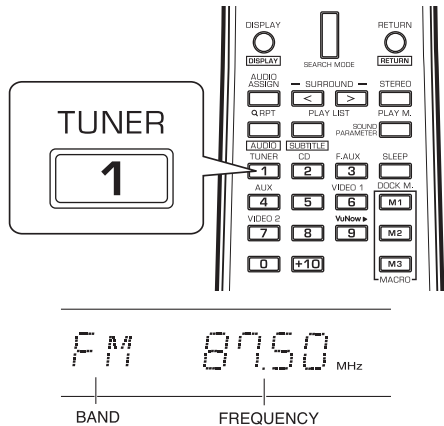

Each time this button is pressed, the band changes as follows :

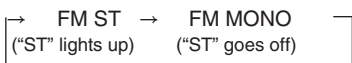

When FM stereo broadcasts are poor because of weak broadcast signals, select the FM mono mode to reduce the noise, then FM broadcasts are reproduced in monaural sound.

2. Press the TUNING buttons for more than 0.5 second.

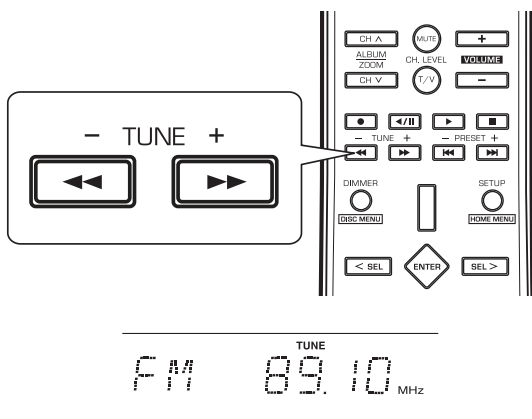

- The tuner will now search until a station of sufficient strength has been found. The display shows the tuned frequency and "TUNE".
- If the station found is not the desired one, simply repeat this operation.
- Weak stations are skipped during auto tuning.

## Manual tuning

- Manual tuning is useful when you already know the frequency of the desired station.
- After selecting the desired band, press the TUNING buttons repeatedly until the right frequency has been reached.

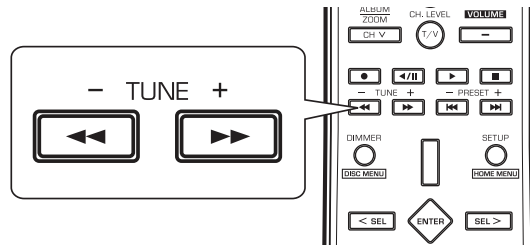

## Auto presetting

- Auto presetting function automatically searches for FM stations only and store them in the memory.
- While listening to FM radio broadcasts, press and hold down the ENTER button for more than 2 seconds.

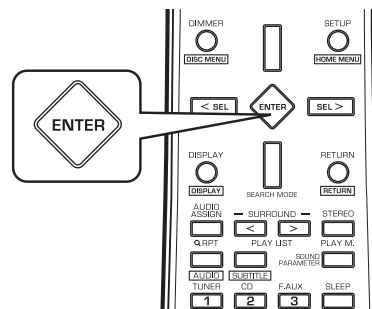

- Then "AUTO MEM" flickers and this receiver starts auto presetting.
- To stop auto presetting, press this button again.
- Up to 30 FM stations can be stored.

**Notes:**

- FM stations of weak strength cannot be memorized.
- To memorize weak stations, perform "Manual presetting" procedure with using "Manual tuning" operation.

## Presetting radio stations

- You can store up to 30 preferred stations in the memory.

1. Tune in the desired station with auto or manual tuning.

2. Press the ENTER button.

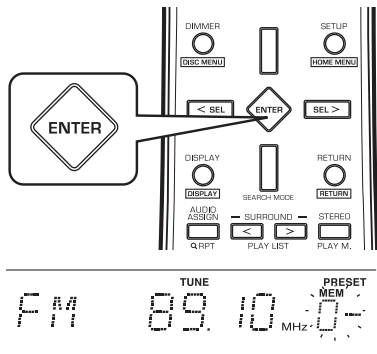

- "MEM", etc. flicker.

3. Select the desired preset number (1~30) and press the ENTER button.

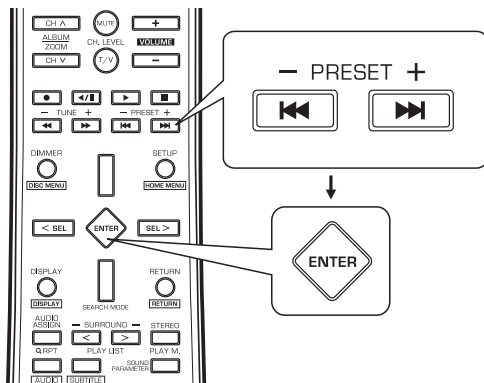

- The station has now been stored in the memory.
- A stored frequency is erased from the memory by storing another frequency in its place.

4. Repeat the above steps 1 to 3 to memorize other stations.

### ■ MEMORY BACKUP FUNCTION

The following items, set before the receiver is turned off, are memorized.

- INPUT SELECTOR settings
- Surround mode settings
- Preset stations, etc.

## Tuning to preset stations

- After selecting the tuner as an input source, select the desired preset number.

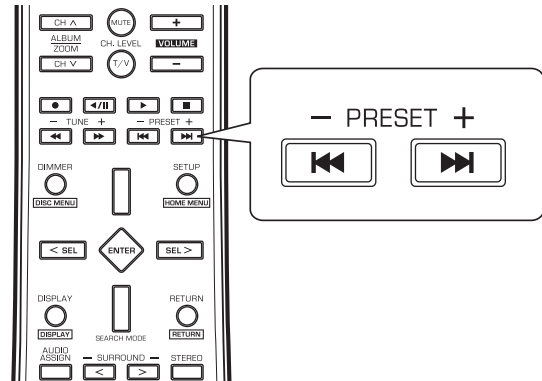

## RDS Tuner(Regional Option for some countries in Europe, etc.)

### LISTENING TO RDS BROADCASTS(FM ONLY)

RDS(Radio Data System) is a method for sending information signals together with the transmitter signals. Your tuner is capable of translating these signals and putting the information on the display. These codes contain the following information. Program Service name(PS), A list of Program Types(PHY), Radio Text(RT).

#### ■Notes :

- In the other countries, RDS tuner function cannot be available.
- RDS is only possible in the FM band.
- RDS searches for the preset stations only. If no stations have been stored in the memory, or if the program type could not be found among the preset stations, "NO PHY" is displayed. Therefore, preset the radio stations before searching for RDS stations.

### Searching for stations by program type

- You can search for stations by program type.

1. In the FM mode, press the SEARCH MODE button.

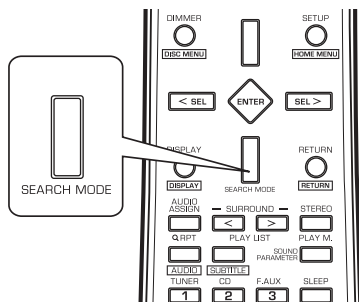

- "SEARCH" is displayed for several seconds.

2. While displaying "SEARCH", select the desired program type.

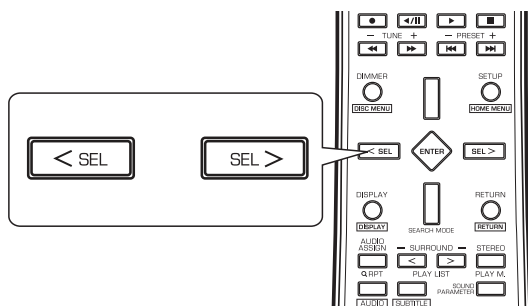

- Each time these buttons are pressed, one of different types of programs is selected. (NEWS, AFFAIRS, INFO, SPORT, EDUCATE, DRAMA, CULTURE, SCIENCE, VARIED, POP M, ROCK M, EASY M, LIGHT M, CLASSICS, OTHER M, WEATHER, FINANCE, CHILDREN, SOCIAL, RELIGION, PHONE IN, TRAVEL, LEISURE, JAZZ, COUNTRY, NATION M, OLDIES, FOLK M, DOCUMENT)
- If "SEARCH" disappears, press the SEARCH MODE button again.

3. While displaying the selected program type, press the ENTER button.

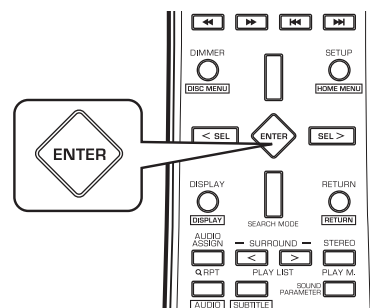

- The tuner start searching through the preset stations for a match.
- When a station is found, the search stops and the stations plays for five seconds.
- If no stations is found, "NO PHY" is displayed.

4. If you want to keep listening to the station, press the ENTER button within the five seconds.

- If you don't press the ENTER button, searching resumes.

## Displaying RDS information

- In the FM mode,

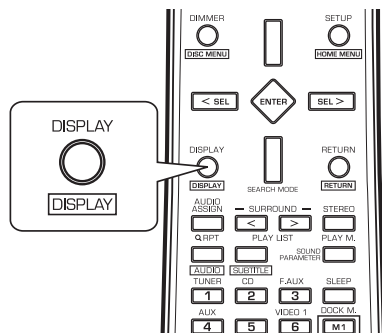

- Each time the DISPLAY button is pressed, the display mode changes as follows:

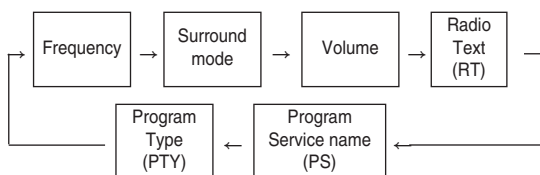

- \* Radio Text (RT) - Messages sent by the radio station. For example, a talk radio station may provide a phone number as RT.
- \* Program Service Name (PS) - The name of the radio station.
- \* Program Type (PTY) - This indicates the kind of program currently being broadcast.
- \* If the signals are too weak or no RDS service is available, "NO TEXT", "NO NAME" or "NO PTY" will be displayed.

## OTHER FUNCTIONS

### Operating the sleep timer

- The sleep timer allows the system to continue to operate for a specified period of time before automatically shutting off.
- To set the receiver to automatically turn off after the specified period of time.

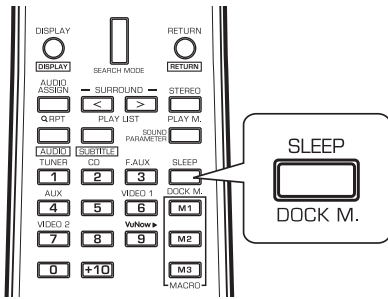

- Each time this button is pressed, the sleep time changes as follows:

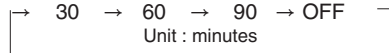

- While operating the sleep timer, “” lights up.
- When the sleep time is selected, the fluorescent display is dimly lit.

### Adjusting the brightness of the fluorescent display

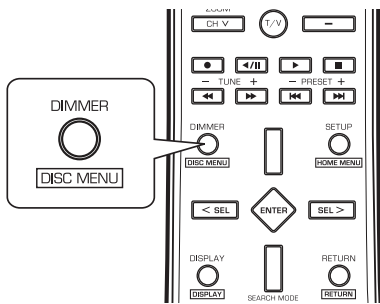

- Each time this button is pressed, the brightness of the fluorescent display changes as follows:

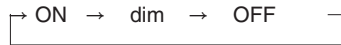

- In the display OFF mode, if some buttons are pressed, the display OFF mode may be canceled for several seconds depending on operation status.

### Displaying the operation status

During playback,

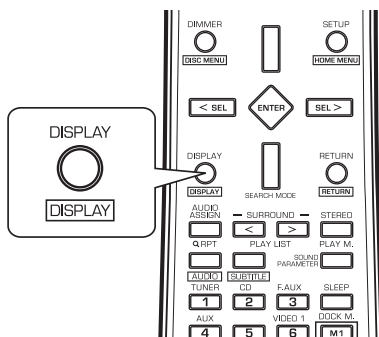

- Each time this button is pressed, the display mode changes as follows:

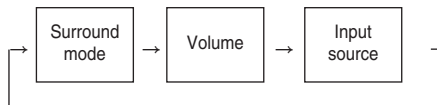

- When RDS tuner function is available in your country, for details on the FM mode information, see “Displaying RDS information” on page 30.

## ROOM2 SOURCE PLAYBACK

- This function allows enjoying one source in the main room and playing another in a different room at the same time.

### ■Notes:

- Only the analog input signal from the ROOM2 source can be heard. So, be sure to make analog audio connection and select analog input for ROOM2 source.
- Even when this receiver enters the standby mode, in such a case that "R2", etc. light up dim and the SURROUND </>, STEREO and VOLUME +/- buttons on the front panel light up blue as it does in the operating mode, meaning only the ROOM2 circuitry operates, the ROOM2 source can be played independently.
- When you do not use the ROOM2 function, turn off the ROOM2 function to save electricity.

### 1. Turn on the ROOM2 function.

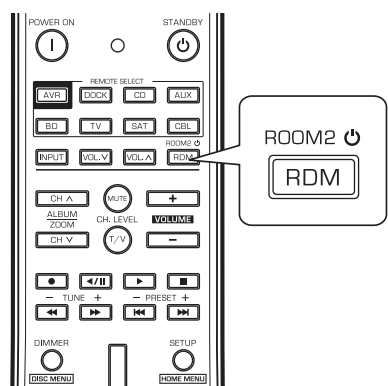

- "ROOM2 ~" is displayed for several seconds.
- Each time the ROOM2 button is pressed, the ROOM2 mode changes as follows :  
ON : To turn on the ROOM2 function.  
↓ ("R2" lights up.)  
OFF : To turn it off. ("R2" goes off.)

### ■Notes:

- To hear the sound of ROOM2 source from the speakers connected to the SURROUND BACK/ROOM2 terminal, you should set the "AMP" to "R2" first. (For details, refer to "When selecting the AMP ASSIGN" on page 35.)
- When the ROOM2 mode is set to OFF, you cannot select the ROOM2 input and adjust the ROOM2 volume.

### 2. Select the desired input as a ROOM2 source.

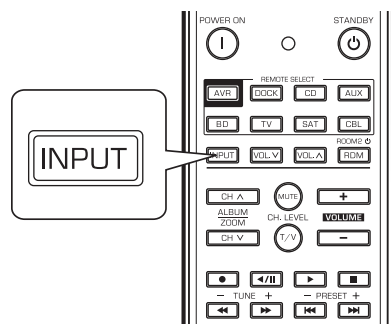

- Each time this button is pressed, the ROOM2 input can be selected among CD, AUX, F.AUX, TUNER, VIDEO1, V2/IPD.

### 3. Adjust the ROOM2 volume.

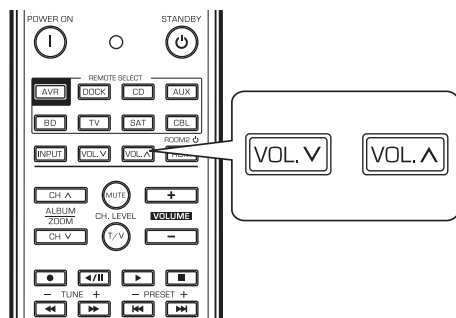

### 4. Start play on the component related to the ROOM2 source.



# System Setup

- The setup menu is displayed on the fluorescent and allows you to perform the setup procedures easily. In most situations, you will only need to set this once during the installation and layout of your home theater, and it rarely needs to be changed later. The setup menu consists of 4 main menus; SYSTEM, SET ROOM EQ, SPEAKER SETUP and MULTI ROOM SETUP. These menus are then divided up into various sub-menus.

## 1. Turn the setup menu on.

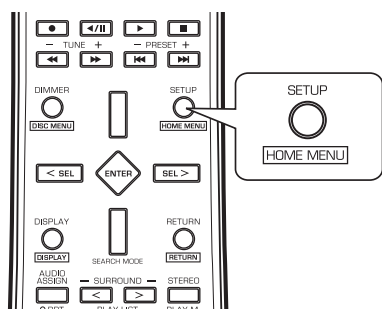

- The setup menu will be shown.
- To turn the menu off, press this button again.

### Notes:

- When the VuNow is selected as an input source, the system setup cannot be performed.

## 2. Select the desired menu using the CURSOR UP/DOWN buttons.

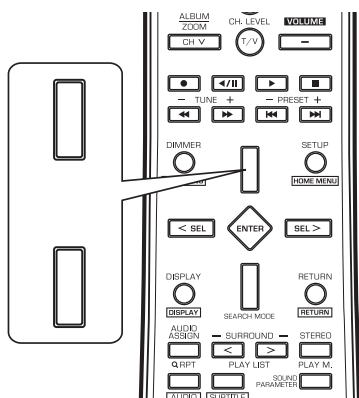

## 3. Confirm your selection.

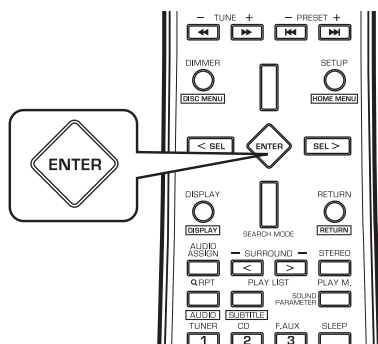

- When selecting "SYSTEM", see "SETTING THE SYSTEM" on page 35.
- When selecting "SET RMEQ", see "SETTING THE ROOM EQ" on page 36.
- When selecting "SPK SET", see "SETTING THE SPEAKER SETUP" on page 37.
- When selecting "MLT ROOM", see "SETTING THE MULTI ROOM SETUP" on page 41.

### ■ Setup menu flow

• The setup menu flow is as follows :

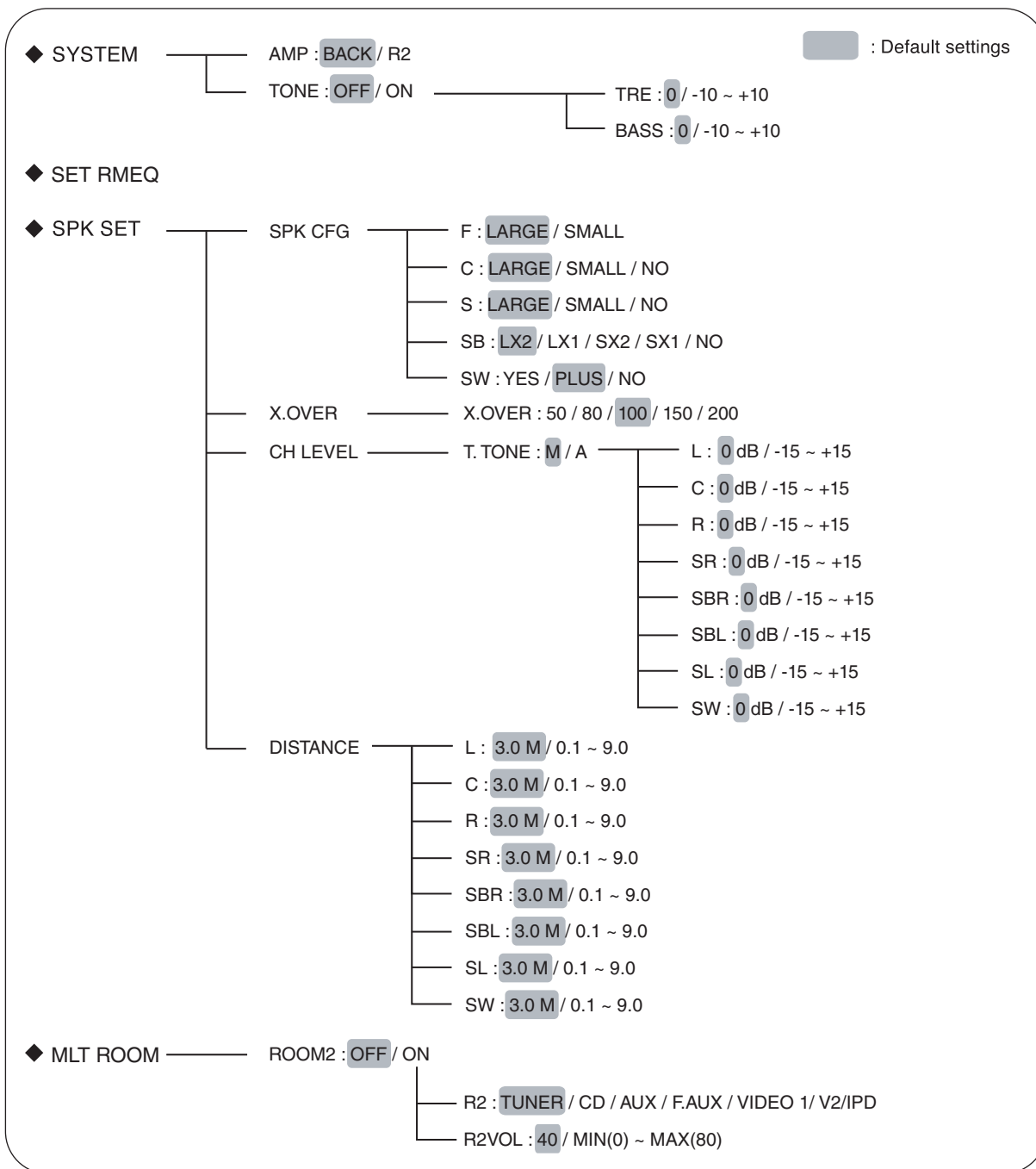

• When "RETURN" is selected on a sub-menu, it will returns to the previous menu.

### ■ Notes :

- "MLT ROOM" can be selected only when the "AMP" is set to "R2". (For details, refer to "When selecting the AMP ASSIGN" on page 35.)
- During setup menu operation, only the (POWER ON)/ STANDBY button and the buttons required for system setup will function.

## SETTING THE SYSTEM

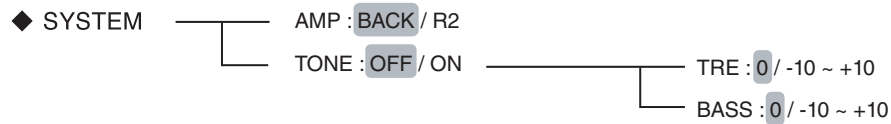

- AMP (AMP ASSIGN) : To assign the surround back channels' power amplifier correctly depending on how to use the speakers.
- TONE : To adjust the tone (bass and treble) as desired.

**1.** Press the CURSOR UP/DOWN buttons to select the desired item.

**2.** Press the CURSOR LEFT/RIGHT buttons to set the selected item as desired.

### ■When selecting the AMP ASSIGN

- The surround back channels' power amplifier can drive the surround back speakers or the ROOM 2 speakers. Depending on how to use the speakers, you should assign the power amplifier correctly. (For details, refer to "CONNECTING SPEAKERS" on page 7 and "CONNECTING ROOM2 SPEAKERS" on page 8.)

BACK (SURROUND BACK) : To drive the surround back speakers when connecting the SURROUND BACK/ROOM2 channels to them.

R2 (ROOM2) : To drive the ROOM2 speakers when connecting the SURROUND BACK/ROOM2 channels to them.

### ■When selecting the TONE

OFF : To listen to a program source without the tone effect. ("DIR" lights up.)

ON : To adjust the tone for your taste. ("DIR" goes off.)

◆When the TONE CONTROL is set to ON to adjust the tone (bass and treble)

- ①. Press the ENTER button to enter the tone adjustment mode.
  - Then "TRE ~" will be displayed.
- ②. Press the CURSOR UP/DOWN buttons to select the desired tone mode.
- ③. Press the CURSOR LEFT/RIGHT buttons to adjust the selected tone as desired.
  - The tone level can be adjusted within the range of -10 ~ +10 dB.
  - In general, we recommend the bass and treble to be adjusted to 0 dB (flat level).
  - Extreme settings at high volume may damage your speakers.
  - To complete tone adjustment, repeat the above steps ② and ③.

## SETTING THE ROOM EQ

- Room EQ lets you avoid troublesome listening-based speaker setup and achieve good surround sound. Room EQ has the feature that provides the optimum listening environment at the listening position in your room. You should connect the supplied microphone to the SETUP MIC jack so that this receiver can analyze the information from a series of test tones emitted from speakers at listening position and can adjust the size, channel level, distance and frequency response of each speaker automatically.
- If you want to personalize your speaker setup by making the settings manually, perform the "SETTING THE SPEAKER SETUP" on page 37.
- After the Room EQ setup has been completed, set the Room EQ as desired. (For details, refer to "When selecting the "EQ (Room EQ)" on page 23.)

### ■ Preparations

- ①. Check that the speakers are securely connected to this receiver.
  - If your subwoofer has adjustable volume and crossover frequency, set the volume halfway and set the crossover frequency to the maximum or the low pass filter off.
- ②. Connect the supplied microphone to the SETUP MIC jack on the front panel.(For details, refer to "SETUP MIC JACK" on page 11.)

### ■ Notes :

- Because the microphone for Room EQ setup is designed for use with this receiver, to use the Room EQ setup function, do not use a microphone other than the one supplied with this receiver.
- After you have completed the Room EQ setup procedure, disconnect the microphone.

## 1. Place the microphone on a flat level surface at the listening position.

- If possible, use a tripod, etc. to attach the microphone at the same height as your ears would be when you are seated in your listening position.
- Ensure there are no obstacles between the speakers and the microphone.

## 2. Press the ENTER button to check the speaker configuration when "SET RMEQ" is displayed.

- "SET RMEQ" flickers while the receiver outputs the test tones to determine the speakers present in your setup and then "CHECK OK" is displayed.

### ■ Notes :

- Try to be as quiet as possible while outputting the test tones.
- For correct speaker settings, do not adjust the volume while outputting the test tones.
- If there is too much ambient noise, error message will be displayed.  
In such a case, press the ENTER button to confirm "RETRY?" after checking for ambient noise.
- If there may be a problem with speaker connection, "ERR ~" (error message) will be displayed.  
If confirming "RETRY?" with pressing the ENTER button does not fix the problem, turn off the power and check the speaker connection.

## 3. To check the speaker configuration, press the CURSOR UP/DOWN buttons to select the speaker.

- Each time the CURSOR UP/DOWN buttons are pressed, the speaker is changed.
- If the speaker configuration is not correct, press the CURSOR LEFT/RIGHT buttons to change the setting. When the correction is finished, confirm the speaker configuration.

## 4. To confirm the speaker configuration, press the CURSOR UP/DOWN buttons to select "CHECK OK", then press the ENTER button.

- Then the Room EQ setup will start.
- If any operation is not performed while displaying "CHECK OK" for 10 seconds, the Room EQ setup will start automatically.

## 5. If the Room EQ setup has been completed, it will be returned to the Room EQ setup.

- Then the settings made in the Room EQ setup are memorized. You can check these settings on the "SPEAKER SETUP" menu. (For details, refer to "SETTING THE SPEAKER SETUP" on page 37.)

## SETTING THE SPEAKER SETUP

- After you have installed this receiver and connected all the components, you should adjust the speaker settings for the optimum sound acoustic according to your environment and speaker layout.
- Even when you change speakers, speaker positions, or the layout of your listening environment, you should adjust the speaker settings, too.
- When performing the Room EQ setup procedure, you need not perform the SPEAKER CONFIGURATION, the CHANNEL LEVEL and the SPEAKER DISTANCE procedures. (For details, refer to “SETTING THE ROOM EQ” on page 36.)

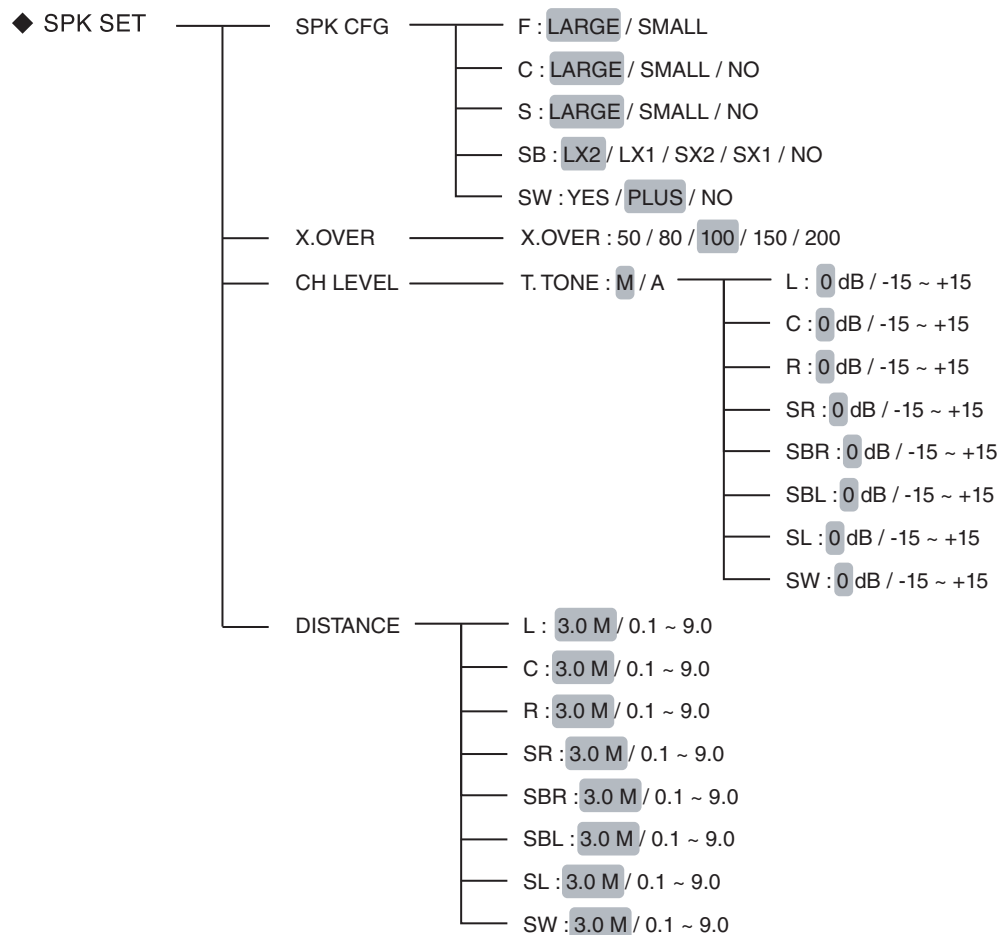

- SPK CFG (SPEAKER CONFIGURATION) : To adjust the speakers depending on whether they are connected or not.
- X.OVER (CROSSOVER FREQUENCY) : To select the desired crossover frequency.
- CH (CHANNEL) LEVEL : To adjust each channel level with the test tone.
- DISTANCE (SPEAKER DISTANCE) : To select the distance between the listening position and each speaker to set the delay time automatically for optimum surround playback.

## When selecting the SPEAKER CONFIGURATION

**1.** Press the CURSOR UP/DOWN buttons to select the “SPK CFG”, then press the ENTER button.

- Then “F ~” will be displayed.

**2.** Press the CURSOR UP/DOWN buttons to select the desired speaker.

**3.** Press the CURSOR LEFT/RIGHT buttons to set the selected speaker as desired.

- Depending on your speaker type, you can select one of these following speaker types.
- Front, Center, Surround and Surround Back speakers :
  - LARGE (or L) : Select this when connecting speakers that can fully reproduce sounds below crossover frequency.
  - SMALL (or S) : Select this when connecting speakers that can not fully reproduce sounds below crossover frequency.
    - When this is selected, sounds below crossover frequency are sent to the subwoofer or speakers which are set to “LARGE” (when not using a subwoofer).
  - NO : Select this when no speakers are connected. When this is selected, sounds are sent to the speakers which are not set to “NO”.
  - ( ) : Selectable for Surround Back speakers.
- Surround Back speakers :
  - x2/x1 : Select the desired depending on the number of speakers connected to SURROUND BACK/ROOM2 terminals.
- SubWoofer :
  - YES : Select this to output LFE signals and bass frequencies of channels set to “SMALL” from the subwoofer.
  - PLUS : Select this if you want the subwoofer to output bass sound continuously or you want deeper bass (the bass frequencies that would normally come out the front and center speakers are also routed to the subwoofer.)
  - NO : Select this when the subwoofer is not connected. The bass frequencies are output from other speakers.

### ■ Notes :

- When speakers are set to “SMALL”, you should set their crossover frequency correctly according to their frequency characteristics. (For details, refer to “When selecting the CROSSOVER FREQUENCY” on page 39.)
- When the “F” (Front) is set to “SMALL”, “C” (Center), “S” (Surround) and “SB” (Surround Back) cannot be set to “LARGE” and the “SW” (SubWoofer) cannot be set to “NO”.
- When the “S” (Surround) is set to “SMALL”, the “SB” (Surround Back) cannot be set to “L” (Large).

**4.** Repeat the above steps 2 and 3 until the speakers are all set to the desired mode.

### ■ About the speaker size

- Select “LARGE” or “SMALL” not according to the actual size of the speaker but according to the speaker’s capacity for playing low frequency (bass sound below frequency set on the “CROSSOVER FREQUENCY” menu) signals.
- If you do not know, try comparing the sound at both settings (setting the volume to a level low enough so as not to damage the speakers) to determine the proper setting.

---

## When selecting the CROSSOVER FREQUENCY

---

**1.** Press the CURSOR UP/DOWN buttons to select the "X.OVER", then press the ENTER button.

- Then "X.OVER ~" will be displayed.

**2.** Press the CURSOR LEFT/RIGHT buttons to set the crossover frequency as desired.

- You can select the crossover frequency among 50, 80, 100, 150 and 200 Hz.

■ **About the crossover frequency**

- When speakers are set to "SMALL", low frequencies in those channels that are below the crossover frequency are to output from subwoofer or front speakers which are set to "LARGE" (when not using a subwoofer).
- Refer to the operating instructions of the speakers to be connected. If the frequency range of your speaker is 100Hz ~ 20kHz, the crossover frequency should be set to 100 Hz (or slightly higher).

---

## When selecting the CHANNEL LEVEL

---

**1.** Press the CURSOR UP/DOWN buttons to select the "CH LEVEL", then press the ENTER button.

- Then "T.TONE ~" will be displayed.

**2.** Press the CURSOR LEFT/RIGHT buttons to select the desired mode.

- Each time these buttons are pressed, the mode changes as follows :

M (MANUAL) : To move the test tone manually from speaker to speaker and to adjust the individual channel levels.

↓

A (AUTO) : To adjust the channel levels as the test tone moves from speaker to speaker automatically.

**3.** Press the ENTER button to confirm your selection.

- After the volume increases to the reference level, test tone will be output.
- When the "A" (AUTO) is selected, the test tone will be output from each speaker for 2 seconds.

**4.** Press the CURSOR LEFT/RIGHT buttons to adjust the level of each channel.

- When the "M" (MANUAL) is selected, select the speakers to be output the test tone with using the CURSOR UP/DOWN buttons.
- You can adjust the channel level within the range of -15 ~ +15 dB.

■ **Note :**

- The test tone will not be output from the speakers set to "NO".

**5.** To cancel the test tone function, press the RETURN button.

- The previous menu will be returned.

## When selecting the SPEAKER DISTANCE

1. Press the CURSOR UP/DOWN buttons to select the "DISTANCE", then press the ENTER button.

---

- Then "L ~" will be displayed.

2. Press the CURSOR UP/DOWN buttons to select the desired speaker.

---

■ **Note :**

- You cannot select the speakers set to "NO".

3. Press the CURSOR LEFT/RIGHT buttons to set the selected speakers as desired.

---

- You cannot set the distance within the range of 0.1 ~ 9.0 meters in 0.1 meter intervals.

4. Repeat the above steps 2 and 3 until the distances are all set as desired.

---

■ **About the speaker distance**

When enjoying multi-channel surround playback with Dolby Digital and DTS sources, etc., it is ideal that the center, surround, surround back and subwoofer speakers should be the same distance from the main listening position as the front speakers. By entering the distance between the listening position and each speaker, the delay times of center, surround, surround back and subwoofer speakers are automatically adjusted to create an ideal listening environment virtually as if the center, surround, surround back and subwoofer speakers were at their ideal locations respectively.



## SETTING THE MULTI ROOM SETUP

- The ROOM2 function allows enjoying one source in the main room and playing another in a different room at the same time.



- ROOM2 (ROOM2 mode) : To turn on or off the ROOM2 function.
- R2 (ROOM2 input) : To select the desired ROOM2 source.
- R2VOL (ROOM2 volume) : To adjust the ROOM2 volume.

### ■Notes :

- To select “MLT ROOM”, set the “AMP” to “R2” first. (For details, refer to “When selecting the AMP ASSIGN” on page 35.)
- Only the analog input signal from the ROOM2 source can be heard. So, be sure to make analog audio connection and select analog input for ROOM2 source.

### 1. Press the CURSOR LEFT/RIGHT buttons to set the ROOM2 mode as desired.

- Each time these buttons are pressed, the ROOM2 mode changes as follows :

ON : To turn on the ROOM2 function. (“R2” lights up.)

↓

OFF : To turn it off. (“R2” goes off.)

### ■Notes :

- When the ROOM2 mode is set to OFF, you cannot select the ROOM2 input and adjust the ROOM2 volume.
- When you do not use the ROOM2 function, turn off the ROOM2 function to save electricity.

### ■When the ROOM2 mode is set to ON

### 2. Press the CURSOR UP/DOWN buttons to select the desired item.

### 3. Press the CURSOR LEFT/RIGHT buttons to set the selected item as desired.

#### ■When selecting the ROOM2 input

- You can select the desired among CD, AUX, F.AUX, TUNER, VIDEO1, V2/IPD.

#### ■When selecting the ROOM2 volume

- You can adjust the ROOM2 volume within the range of 0 ~ 80 dB.

## Troubleshooting Guide

If a fault occurs, run through the table below before taking your receiver for repair.

If the fault persists, attempt to solve it by switching the receiver off and on again. If this fails to resolve the situation, consult your dealer. Under no circumstances should you attempt to repair the receiver yourself. This could void the warranty.

PROBLEM	POSSIBLE CAUSE	REMEDY
No power	<ul style="list-style-type: none"> <li>The AC input cord is disconnected.</li> <li>Poor connection at AC wall outlet or the outlet is dead or off.</li> </ul>	<ul style="list-style-type: none"> <li>Connect cord securely.</li> <li>Check the outlet using a lamp or another appliance.</li> </ul>
No sound	<ul style="list-style-type: none"> <li>The speaker wires are disconnected.</li> <li>The master volume is adjusted too low.</li> <li>The MUTE button is pressed to ON.</li> <li>Incorrect selection of input source.</li> <li>Incorrect connections between the components.</li> <li>The HDMI Audio Out is set to THRU.</li> </ul>	<ul style="list-style-type: none"> <li>Check the speaker connections.</li> <li>Adjust the master volume.</li> <li>Press the MUTE button to cancel the muting effect.</li> <li>Select the desired input source correctly.</li> <li>Make connections correctly.</li> <li>Set it to AMP. (For details, refer to "When selecting the HDMI (HDMI Audio Out)" on page 24.)</li> </ul>
No sound from the surround speakers	<ul style="list-style-type: none"> <li>Surround mode is switched off(stereo mode).</li> <li>Master volume and surround level are too low.</li> <li>Monaural source is used.</li> <li>Surround speaker setting is "NO".</li> </ul>	<ul style="list-style-type: none"> <li>Select a surround mode.</li> <li>Adjust master volume and surround level.</li> <li>Select a stereo or surround source.</li> <li>Select the desired surround speaker setting.</li> </ul>
No sound from the center speaker	<ul style="list-style-type: none"> <li>Stereo mode, etc is selected.</li> <li>Center speaker setting is "NO".</li> <li>Master volume and center level are too low.</li> </ul>	<ul style="list-style-type: none"> <li>Select the desired surround mode.</li> <li>Select the desired center speaker setting.</li> <li>Adjust master volume and center level.</li> </ul>
No sound from the surround back speakers	<ul style="list-style-type: none"> <li>The input signal format or the current surround mode cannot support the 7.1(or 6.1) surround.</li> <li>The surround back channels' power amplifier is assigned to "R2".</li> <li>Master volume and surround back level are too low.</li> <li>Surround back speaker setting is "NO".</li> </ul>	<ul style="list-style-type: none"> <li>Under the proper situations, perform the 7.1(or 6.1) surround playback.(For details, refer to "ENJOYING SURROUND SOUND" on page 22.)</li> <li>Assign the power amplifier to the surround back channels.(For details, refer to "When selecting the AMP ASSIGN" on page 35.)</li> <li>Adjust master volume and surround back level.</li> <li>Select the desired surround back speaker setting.</li> </ul>
No picture	<ul style="list-style-type: none"> <li>Video connections between this unit and the monitor TV are not made correctly.</li> <li>Incorrect selection of input source on the monitor TV.</li> </ul>	<ul style="list-style-type: none"> <li>Make proper video connections.</li> <li>Select the input source correctly.</li> </ul>
No picture with an HDMI connection	<ul style="list-style-type: none"> <li>HDMI connection between this unit and the monitor TV is not made correctly.</li> <li>The monitor TV or other equipments do not support HDCP.</li> </ul>	<ul style="list-style-type: none"> <li>Make proper HDMI connection.</li> <li>This unit will not output video signal unless the connected equipments supports HDCP.</li> </ul>
Noise or distorted picture	<ul style="list-style-type: none"> <li>Video format of your monitor TV, BD/DVD player, etc. is different from PAL.</li> </ul>	<ul style="list-style-type: none"> <li>Change the video format to PAL.</li> </ul>
Stations cannot be received	<ul style="list-style-type: none"> <li>No antenna is connected.</li> <li>The desired station frequency is not tuned in.</li> <li>Antenna is in wrong position.</li> </ul>	<ul style="list-style-type: none"> <li>Connect an antenna.</li> <li>Tune in the desired station frequency.</li> <li>Move antenna and retry tuning.</li> </ul>
Preset stations cannot be received	<ul style="list-style-type: none"> <li>An incorrect station frequency has been memorized.</li> <li>The memorized stations are cleared.</li> </ul>	<ul style="list-style-type: none"> <li>Memorize the correct station frequency.</li> <li>Memorize the stations again.</li> </ul>
Poor FM reception	<ul style="list-style-type: none"> <li>No antenna is connected.</li> <li>The antenna is not positioned for the best reception.</li> <li>Weak signals.</li> </ul>	<ul style="list-style-type: none"> <li>Connect an antenna.</li> <li>Change the position of the antenna.</li> <li>Install an outdoor FM antenna.</li> </ul>
Remote control unit does not operate.	<ul style="list-style-type: none"> <li>Batteries are not loaded or exhausted.</li> <li>The remote sensor is obstructed.</li> </ul>	<ul style="list-style-type: none"> <li>Replace the batteries.</li> <li>Remove the obstacle.</li> </ul>

# Specifications

## ■ AMPLIFIER SECTION

- Power output, stereo mode, 6  $\Omega$ , THD 0.5%, 1 kHz | **2 $\times$  100 W**
- Total harmonic distortion at -3 dB, 6  $\Omega$ , 1 kHz | **0.5%**
- Input sensitivity/impedance
  - Line (CD, AUX, VIDEO) | **200 mV/47k $\Omega$**
- Signal to noise ratio, IHF "A" weighted
  - Line (CD, AUX, VIDEO) | **100 dB**
- Frequency response
  - Line (CD, AUX, VIDEO), 20 Hz ~ 70 kHz | **+0, -3 dB**
- Bass/Treble control, 100 Hz/10 kHz |  **$\pm$ 10 dB**
- Surround mode, only channel driven
  - Front power output, 6  $\Omega$ , 1 kHz, THD 0.7 % | **100 W / 100 W**
  - Center power output, 6  $\Omega$ , 1 kHz, THD 0.7 % | **100 W**
  - Surround power output, 6  $\Omega$ , 1 kHz, THD 0.7 % | **100 W / 100 W**
  - Surround back / ROOM2 power output, 6  $\Omega$ , 1 kHz, THD 0.7 % | **100 W / 100 W**

## ■ DIGITAL AUDIO SECTION

- Sampling frequency | **32, 44.1, 48, 96, 192 kHz**
- Digital input level
  - Coaxial, 75  $\Omega$  | **0.5 Vp-p**
  - Optical, 660 nm | **-15 ~ -21 dBm**

## ■ VIDEO SECTION

- Video format | **PAL**
- Input sensitivity(=Output level), 75  $\Omega$ 
  - Video (Composite(normal)) | **1 Vp-p**
  - Component video (R-Y signal) | **0.5 Vp-p**
  - (B-Y signal) | **0.5 Vp-p**
  - (Y signal) | **1.0 Vp-p**
- HDMI connector | **19 pin**

## ■ FM TUNER SECTION

- Tuning frequency range | **87.5~108 MHz**
- Usable sensitivity, THD 3%, S/N 26 dB | **9 dBf**
- 46 dB quieting sensitivity, mono/stereo | **20.2 / 45.3 dBf**
- Signal to noise ratio, 65 dBf, mono/stereo | **70 / 65 dB**
- Total harmonic distortion, 65 dBf, 1 kHz, mono/stereo | **0.8 / 1.0 %**
- Frequency response, 30 Hz~15 kHz |  **$\pm$ 3 dB**
- Stereo separation, 1 kHz | **30 dB**
- IF rejection ratio | **70 dB**

## ■ GENERAL

- Power supply | **230 V ~ 50 Hz**
- Power consumption | **120 W**
- Dimensions (W $\times$  H $\times$  D, including protruding parts) | **430 x 72 x 306 mm(17 x 2-7/8 x 12 inches)**
- Weight (Net) | **4.53 kg (10.0 lbs)**

Note: Design and specifications are subject to change without notice for improvements.

# Setup Code Table

## TV

ENGLISH

ADMIRAL	050	134				
AKAI	093	049	123			
ALBA	068					
ALBIRAL	116					
ALCATEL	022					
AMSTRAD	158	021				
ANAM	155	156	157			
ARC EN CIEL	028	039	043	145	081	
ARISTONA	099	049	050	019	142	149
	078					
ARTHUR MARTIN	053	139	117	120	122	123
	125	128				
ASA	050	055	057	113	134	
ATLANTIC	099	111				
AUDIOSONIC	054					
AUSIND	053					
AUTOVOX	099	144	055	019	057	069
BAIRD	083					
BASICLINE	006					
BAUR	011					
BEKO	023	049				
BLAUPUNKT	094	100	102	111	114	
BENQ	159					
BRANDT	028	039	040	043	145	081
BRION VEGA	050					
BRUNS	048	050				
BSR	059	110	132			
BUSH	033	068	124	074		
CENTURY	098	101	050	079	136	
CGE	016	101	124	079	132	136
CIHAN	065					
CLARIVOX	048	116				
CONDOR	099	111				
CONTEC	087					
CONTINENTAL						
EDITION	028	039	040	043	145	081
CROSLEY	101	050	109			
CROWN	147					
CTC CLATRONIC	046					
DAEWOO	089					
DECCA	099	060	063	115	118	
DEGRAAF	036					
DIXI	049	090				
DRYNATRON	049					
DUAL	099	141				
DUAL-TEC	096	099	132			
DUMONT	046	050	057	073		
ELBE	016	116				
ELBIT	065					

ELCIT	046	097	103	050	109	127
	132					
ELMAN	046	132				
ELTA	090					
EMERSON	158	098	050			
ERRES	049	142				
EUROPHON	098	046	097	099	051	115
	132					
FERGUSON	146	040	041	150	057	061
	116	149				
FIDELITY	099	149				
FINLUX	034	046	053	055	057	109
	113	073	074	079		
FISHER	015	048	050	052	109	136
FORGESTONE	149					
FORMENTI	099	053	109	111	125	
FORTRESS	137					
FRABA	075					
FRONTECH	054					
FUJITSU	025					
FUNAI	054	059				
GBC	109	132				
GEC	099	060	109	115	134	088
GELOSO	103	109	132	134	090	
GOLDSTAR	092	003	017	099	049	075
	076	077	090	152		
GOODMANS	033	049	060	077		
GORENJE	066	136				
GREATZ	001	058	109	122	123	128
	129	130	134			
GRANADA	033	099	049	058	060	142
	115	125	134			
GRUNDIG	094	100	057	058	108	112
	114	082				
HANSEATIC	033	047	099	049	109	139
	111					
HANTAREX	097					
HEMMERMANN	127					
HIFIVOX	028	039	043	145	081	
HINARI	158	033	045	143	090	
HITACHI	014	033	034	036	099	145
	056	109	139	110	067	117
	132	134	084	091	081	088
HYPER	093	099				
IMPERIAL	016	101	124	079	132	133
INGELEN	001	058	109	122	128	129
	130	134				
SHERWOOD	000	001	002			

INNO HIT	093	098	097	099	143	077	NORDMENDE	028	032	039	043	145	131
	090							091	081				
INTERFUNK	047	049	050	145	058	109	OCEANIC	109	064	123			
	142	123	128	129	091		ONCEAS	099					
IRRADIO	093	143	053	077	090		OPTONICA	137					
ITT	001	140	058	105	109	122	ORION	158	059	118	068	127	090
	123	128	148	129	130	134	OSAKI	060					
	135	083	089				OSIO	077					
JVC	033	154					OSUME	087					
KTV	099						OTTO VERSAND	033	047	049	109	139	
KAISUI	006						P.T ACTTRON	065					
KARCHER	006						PAEL	099	053				
KENDO	098						PANASONIC	030	042	095	104	107	109
KENNEDY	144	019	109					121	126				
KORTING	050	059	111				PATHE CINEMA	099	111	116	132		
KRIESLER	099	049	050	019	142	149	PERDIO	060					
	078						PHILCO	016	030	101	050	109	124
LENOIR	099							079	132	136			
LOEWE OPTA	008	097	047	049	050	115	PHILIPS	009	010	013	018	024	099
	072							049	050	019	142	148	149
LOGIK	118	149						078	088				
LUMA	049	120	134				PHOENIX	099	053	109	111	125	
LUXOR	058	139	117	120	123	129	PHONOLA	099	049	050	019	142	149
	135	083						078					
MAGNADYNE	046	097	103	050	109	115	PIONEER	020	049	145	091		
	127	132					PRANDONI-						
MAGNAFON	046	097	099	051	053	115	PRINCE	098	097	053	115	134	
MARANTZ	049						PREMIER	124					
MATSUI	158	099	106	060	118	068	PRINCE	098	097	053	134		
	134	090					PROTECH	049	054				
McMICHAEL	088						PYE	099	049	050	019	142	148
MEMOREX	090							149	078				
METZ	094	050	114	133			QUASAR	046	097	051	053	077	
MINERVA	094	100	057	058	114		QUELLE	047	099	100	049	053	055
MISTRAL	149							057	058	111	112	113	114
MITSUBISHI	033	035	047	049	050	062		118	123	073	074	128	
	118	119	148	080	138		RADIOLA	099	049	050	019	142	149
MIVAR	097	099	115	077				078					
MULTITECH	046	099	115	136			RADIOMARELLI	046	097	103	050	109	062
MURPHY	134							127	132				
MAONIS	096	144	019	110	134		RANK	074					
NATIONAL	042	104	109				RBM	074					
NEC	033	085					REDIFFUSION	062	123	134			
NECKERMANN	099	050	139	120	136		REX	096	144	019	141	110	069
NEI	049							134					
NIKKAI	060						ROBOTRON	048	050				
NOBLEX	015						RTF	048	050				
NOBLIKO	098	046	099	053	057		SABA	028	031	032	037	039	040
NOGAMATIC	028	039	043	145	081			043	097	050	145	115	120
NOKIA	161	140	058	105	109	122		086	091	081			
	123	128	148	129	130	134	SAISHO	158	099	118	119	068	090
	135	083	089				SALORA	053	139	117	120	122	123
								125	128	135	083		

SAMBERS	046	097	051	053	115	077
SAMPO	121					
SAMSUNG	015	026	099	054	077	136
	090	151	153			
SANYO	161	162	005	033	044	048
	060	113	118	071	054	136
SBR	049	142	148	149	088	
SCHAUB LORENZ	161	058	109	122	123	128
	129	130	134			
SCHNEIDER	096	099	049	050	052	019
	141	109	142	125	149	078
	132					
SEG	046					
SEI	158	059				
SELECO	016	096	144	019	141	110
	069	134				
SHARP	033	087	137			
SIAREM	046	097	050	109	115	
SICATEL	116					
SIEMENS	005	094	036	100	111	114
	087					
SIERA	099	049	050	019	142	149
	078					
SILVER	054					
SINGER	016	046	050	109		
SINUDYNE	158	046	050	059	109	127
SONOKO	049	090				
SONY	146	007	027	033	038	118
STERN	096	144	019	110	069	134
TANDBERG	133					
TANDY	099	060	137			
TASHIKO	162	033				
TATUNG	099	060	063	065	115	118
TEC	096	099	132			
TELEAVIA	028	039	040	043	145	091
	081					
TELEFUNKEN	028	041	145	150	086	091
TELETECH	090					
TELEVIDEON	099	053	109	111	125	
TENSAI	049					
THOMSON	012	028	032	039	040	043
	145	091	081			
THORN- FERGUSON	014	040	041	054	150	057
	061	116	149	086		
TOCOM	029					
TOSHIBA	004	016	033	070	074	
TRANS						
CONTINENTS	098	097	053	134		
TRIUMPH	158					
UHER	052	111	125			
ULTRA VOX	098	046	099	050	109	120

UNIVERSUM	092	034	054	077		
UNIVOX	116					
VEGAVOX	079					
VOXSON	050	134				
WATSON	111					
WATT RADIO	046	099	051	109	116	127
WEGA	033					
WHITE						
WESTINGHOUSE	099	111				
YOKO	099					
ZANUSSI	096	144	019	110	069	134
ZOPPAS	096	144	019	110	134	

**DOCK-VCR**

AKAI	042	022	052	032	033	
ALBA	008	020				
AMSTRAD	011					
ANITSCH	009					
ARC EN CIEL	042	056	052			
ARISTONA	045	031				
ASA	018					
AWIA	011	042				
BAIRD	042	033				
BAUER. BOSCH	014	043				
BLAUPUNKT	014	043	055	031	054	040
BRANDT						
ELECTRONIQUE	042	056	052			
BRIONVEGA	041					
BUSH	008	020				
C.EDISON	041					
CANON	014					
CAPEHART	020					
CGE	011	042	052			
CONTINENTAL						
EDISON	042	056	052			
CRAIG	064	013				
CURTIS MATHES	019					
DAEWOO	001	020	021			
DAYTRON	020					
DECCA	011	042				
DEGRAAF	003	006	011	045	018	
DUAL	042	052				
DUMONT	003	011	018			
DYNATECH	011					
EMERSON	002	010	011	019	025	
FERGUSON	042	059	030	052	034	036
FIDELITY	011					
FINLANDIA	003	018				
FINLUX	003	006	011	018		
FISHER	000	003	005			

FUNAI	011					
GE	019					
GENERAL	014					
GOLDSTAR	004	062				
GOODMANS	008	011	046			
GRAETZ	041	042	056	050	052	038
GRANADA	003	005	018			
GRUNDIG	014	043	018	055	031	053
	054					
HANSEATIC	043					
HARMAN-						
KARDON	004					
HIFIVOX	042	056	052			
HINARI	002	008	024	027		
HITACHI	006	007	011	042	057	
IMPERIAL	011					
INGELEN	042	056	052	038		
INGERSOL	027					
ITT	005	041	042	056	050	052
	033	038				
JENSEN	042					
JVC	042	056	060	030	052	063
KENWOOD	005	042	060			
KRIESLER	045	031				
KUBA	043					
LLOYD	011					
LOEWE OPTA	014	018	029	031		
LOGIK	008	027				
LUXOR	033	038				
MAGNADYNE	041					
MAGNASONIC	038					
MAGNAVOX	019					
MARANTZ	004	014	046	018	031	
MATUI	010	025	027			
MEMOREX	064	003	005	011	045	
METZ	014	043	031	054	037	
MGA	017					
MINERVA	055	054				
MINOLTA	006	007				
MITSUBISHI	060	017	049			
MTC	011	013				
MULTITECH	008	011				
MURPHY	011					
NAONIS	042	056	052			
NATIONAL	040					
NEC	004	042	060	052		
NECKERMANN	002	041	014	042	052	
NOGAMATIC	042	056	052			
NOKIA	003	005	041	042	056	050
	052	033	038			
NORDMENDE	039	042	056	052	053	035
OPTONICA	045	046				
ORION	002	010	025	027		

OSAKI	011					
OTTO VERAND	043					
P. CINEMA	014					
PALLADIUM	041	014				
PANASONIC	023	051	040			
PATHE MARCONI	042	056	052			
PENTAX	006	007				
PERDIO	011					
PHILIPS	012	014	045	046	018	029
	031					
PHONOLA	014	045	018	029	031	
PIONEER	060					
PORTLAND	020					
PROLINE	011					
PYE	014	045	018	029	031	
QUARTZ	005					
QUELLE	002	044	054			
RADIOLA	045	031				
RADIOMARELLI	041					
RCA	019					
REALISTIC	064	003	005	011	013	045
	046					
REX	042	056	052			
SABA	039	042	056	052	035	
SAISHO	002	010	025	027		
SALORA	005	017				
SAMSUNG	013	019	032	061		
SANSUI	042	060				
SANYO	064	003	005	025	038	
SBR	018	029				
SCHAUB LORENZ	041	042	056	050	052	038
SCHNEIDER	008	011	045	031		
SEI-SINUDYNE	027					
SELECO	042	056	052			
SENTRA	020					
SHARP	045	046	105	048		
SHERWOOD	000					
SHINTOM	008					
SIEMENS	014	043	055	031	054	038
SIERA	045	031				
SINUDYNE	027					
SONY	044	015	016	026	028	
STERN	042	056	052			
STS	006					
SUNKAI	025					
SYLVANIA	011	017				
SYMPHONIC	011	017				
TASHIKO	011					
TATUNG	011	042				
TEAC	011	042				
TEKNIKA	011					
TELEAVIA	042	056	052			
TELEFUNKEN	042	056	052			

TENOSAL	008					
THOMSON	042	056	052			
THORN- FERGUSON	039	042	059	030	052	034
	036					
TOSHIBA	001	042	056	017	058	052
TOTELEVISION	013					
UHER	042					
ULTRA VOX	041					
UNITECH	013					
UNIVERSUM	041	014	043			
URANYA	041					
VECTOR	004					
VICTOR	042	060				
VIDITAL	041					
WESTING HOUSE	041					
WARDS	019					
YAMAHA	004	042				
ZANUSSI	042	056	052			
ZENDER	052					
ZOPPAS	042	056				

**BD/DVD**

DENON	017					
GE	003	004				
JVC	007					
LG	011	010				
MAGNAVOX	019					
MITSUBISHI	001					
ONKYO	009					
PANASONIC	015					
PHILIPS	019					
PIONEER	002	023				
PROSCAN	003	004				
RCA	003	004				
SAMSUNG	016	008				
SHERWOOD	000	010	011	012	013	014
	022	020	021	024		
SONY	005					
THOMSON	003	004				
TOSHIBA	006					
VIETA	014					
YAMAHA	019					
ZENITH	011	010				

**CBL**

ABC	002	003	009	030		
	006	008				
Allegro	018	021				
Archer	018	026				
Bell&Howell	009					
Century	018					
Citizen	018	021				
Comtronics	014					
Contec	011					
Easten	001					
Emerson	026					
Everquest	010	014				
Focus	022					
Garrard	018					
Gemini	010					
General Instrument	033	276	006	034		
GoldStar	017	040				
Goodmind	026					
Hamlin	012	020	004	013		
Hitachi	006					
Jasco	010	018	021			
Jerrold	002	007	033	032	009	010
	006	034				
Movie Time	015					
NSC	015					
Oak	011					
Optimus	031					
Panasonic	016	031				
Philips	018					
Pioneer	017	025				
Popular Mechanics	022					
RCA	031					
Radio Shack	010	021	026	028		
Recoton	022					
Regal	012	020				
Regency	001					
Rembrandt	006					
SL Marx	014					
Samsung	017	014				
Scientific Atlanta	003	023	030	027		
SHERWOOD	000					
Signal	010	014				
Signature	006					
Sprucer	031					
Starcom	002	010				



Stargate	010	014	026
Starquest	010		
TV86	015		
Teleview	014		
Tocom	007	008	
Tusa	010		
Unika	018		
Universal	018	019	
Viewstar	015		
Zenith	024		
Zentek	022		

## SAT

ALBA	030				
AMSTRAD	008	019	027		
ARCON	021				
ARISTONA	016				
ASTRA	028				
BLAUPUNKT	033				
BUSH	016				
CH.MASTER	030				
CITY COM	005				
DDC	030				
DYNASAT	005				
ECHOSTAR	002	009	032	020	
EMME ESSE	005				
FAIT	005				
FERGUSON	014	041	016	017	018
FINLUX	006	007	013		
FRACARRO	005				
FTE	022				
GOLDSTAR	004	021			
GRAETZ	026	037			
GROTHUSEN	004				
GRUNDIG	033	016	018	036	
HINARI	030				
HIRSCHMANN	003	006			
HITACHI	013				
INGELEN	026	037			
ITT	034				
ITT-NOKIA	032	018	026	037	
JERROLD	038	014			
KATHREIN	005	022	023		
KOSMOS	004				
KRIESLER	016				
LENCO	004	021			
LUXOR	026	037			

MAGAI	022				
MARANTZ	012				
MASPRO	016				
METZ	036				
MINERVA	036				
MULTISTAR	022				
MURATO	004				
NEC	040				
NEIRU	021				
NOKIA	026	037			
NORSAT	015				
PACE	001	042	016	017	018 044
PANASONIC	032				
PHILIPS	003	011	012	029	
PHONOLA	016				
PROSAT	030				
PYE	016				
QUADRAL	030				
QUELLE	036				
RADIOLA	016				
REDIFFUSION	015				
SABA	035				
SALORA	026				
SAMSUNG	003	022			
SAT PARTNER	004				
SATPORTNER	021				
SCHAUB LORENZ	026	037			
SCHNEIDER	005	016			
SHERWOOD	000				
SIEMENS	033	036			
SIERA	016				
SILVA	004	021			
SKY	039				
STARCOM	038				
STARSAT	022				
TECHNISAT	003				
TELEFUNKEN	025				
TELESYSTEM	005				
THORN- FERGUSON	010	014	041	016	017 018
	043				
TRIAD	004				
UNIDEN	022				
UNITED CABLE	038				
VTECHNOLOGY	004				
VORTEC	003	024	025		
ZENDER	022				

**CD**

ADCOM	021					
AIWA	045	039	022			
AKAI	046					
AUDIO	016					
ARC EN CIEL	036	014	027	030	031	018
	230					
DENON	054					
FISHER	006					
H/K	017	012	047	016		
JVC	028	034	001			
KENWOOD	003	020	010	029	006	
MARANTZ	015	014				
MONDIAL	033					
NAD	048	002	042			
NAKAMICHI	049					
NIKKO	016					
ONKYI	013	037	011	021	038	
PANASONIC	051	052				
PHILIPS	014					
PIONEER	005	008	041			
RCA	007	009				
REALISTIC	045					
SANSUI	040					
SHARP	019	053				
SHERWOOD	000	035	023	019	056	057
	058					
SONY	050	024	025	026		
TEAC	055	032				
TECHNICS	051	004	052			
VICTOR	001					
YAMAHA	044	043	016			

**AUX-USBIMD**

SHERWOOD	000(for USB)
	015 016(for MD recorder)

**AUX-LD**

DAEWOO	002
DENON	012
GOLDSTAR	004
KENWOOD	003
MAGNAVOX	010
OPTIMUS	007
PANASONIC	013
PHILIPS	010
POINNEER	000 009
RCA	006
REALISTIC	007
SAMSUNG	001 005
SHARP	003 011
TECHINCS	013
TOSHIBA	003
YAMAHA	008



# R-904

DIGITAL A/V RECEIVER



5707-00000-278-0S



## Free Manuals Download Website

<http://myh66.com>

<http://usermanuals.us>

<http://www.somanuals.com>

<http://www.4manuals.cc>

<http://www.manual-lib.com>

<http://www.404manual.com>

<http://www.luxmanual.com>

<http://aubethermostatmanual.com>

Golf course search by state

<http://golfingnear.com>

Email search by domain

<http://emailbydomain.com>

Auto manuals search

<http://auto.somanuals.com>

TV manuals search

<http://tv.somanuals.com>