

# OPERATING INSTRUCTIONS

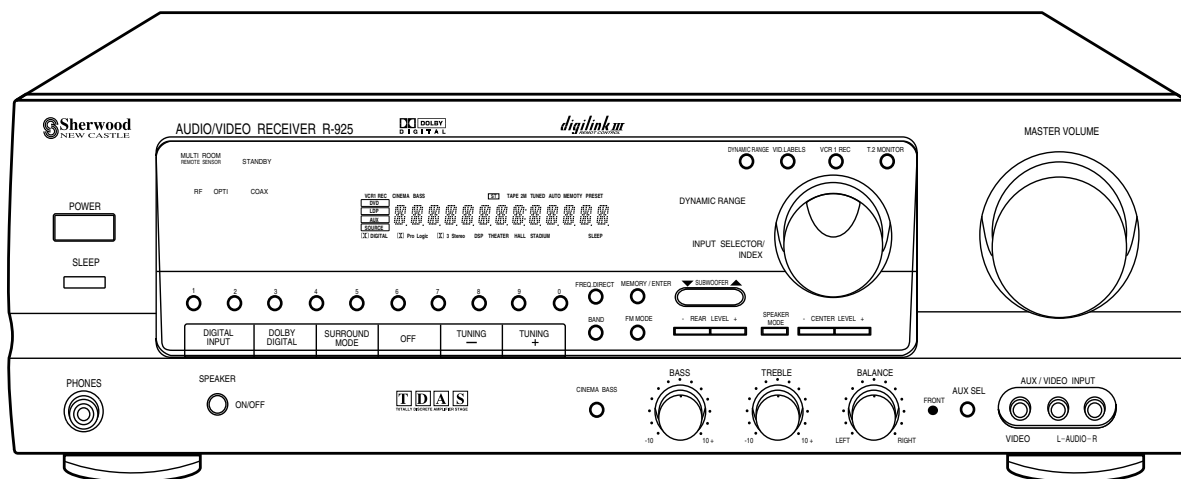

## R-925

### AUDIO/VIDEO RECEIVER



# Introduction

## UNPACKING AND INSTALLATION

### ***Congratulations on Your Purchase!***

Your new high fidelity receiver is designed to deliver maximum enjoyment and years of trouble free service. Please take a few moments to read this manual thoroughly. It will explain the features and operation of your unit and help ensure a trouble free installation. Please unpack your unit carefully. We recommend that you save the carton and packing material. They will be helpful if you ever need to move your unit and may be required if you ever need to return it for service. Your unit is designed to be placed in a horizontal position and it is important to allow at least two inches of space behind your unit for adequate ventilation and cabling convenience.

To avoid early damage, never place the unit near radiators, in front of heating vents, in direct sunlight, or in excessively humid or dusty locations. Connect your complementary components as illustrated in the following section.

	<b>CAUTION</b> RISK OF ELECTRIC SHOCK DO NOT OPEN	
<b>CAUTION : TO REDUCE THE RISK OF ELECTRIC SHOCK, DO NOT REMOVE COVER (OR BACK). NO USER-SERVICEABLE PARTS INSIDE. REFER SERVICING TO QUALIFIED SERVICE PERSONNEL.</b>		



This symbol is intended to alert the user to the presence of uninsulated "dangerous voltage" within the product's enclosure that may be of sufficient magnitude to constitute a risk of electric shock to persons.



This symbol is intended to alert the user to the presence of important operating and maintenance (servicing) instructions in the literature accompanying the appliance.

### **WARNING**

To reduce the risk of fire or electric shock, do not expose this appliance to rain or moisture.

**Caution : Do not block ventilation openings or stack other equipment on the top.**

### **FOR U.S.A.**

■ **Note to CATV System Installer:** This reminder is provided to call the CATV system installer's attention to Article 820-40 of the NEC that provides guidelines for proper grounding and, in particular, specifies that the cable ground shall be connected to the grounding system of the building, as close to the point of cable entry as practical.

### ■ **FCC INFORMATION**

This equipment has been tested and found to comply with the limits for a Class B digital device, pursuant to Part 15 of the FCC Rules. These limits are designed to provide reasonable protection against harmful interference in a residential installation. This equipment generates, uses and can radiate radio frequency energy and, if not installed and used in accordance with the instructions, may cause harmful interference to radio communications. However, there is no guarantee that interference will not occur in a particular installation. If this equipment does cause harmful interference to radio or television reception, which can be determined by turning the equipment off and on, the user is encouraged to try to correct the interference by one or more of the following measures:

- Reorient or relocate the receiving antenna.
- Increase the separation between the equipment and receiver.
- Connect the equipment into an outlet on a circuit different from that to which the receiver is connected.
- Consult the dealer or an experienced radio/TV technician for help.

**CAUTION:** Any changes or modifications in construction of this device which are not expressly approved by the party responsible for compliance could void the user's authority to operate the equipment.

**READ THIS BEFORE OPERATING YOUR UNIT**

**FOR U.S.A. AND CANADA** ..... 120 V

**FOR OTHER COUNTRIES** ..... 110 V/220 V

**FOR YOUR SAFETY**

Units shipped to the U.S.A. and Canada are designed for operation on 120 V AC only.

Safety precaution with use of a polarized AC plug. However, some products may be supplied with a nonpolarized plug.

**CAUTION :** *To prevent electric shock, match wide blade of plug to wide slot, fully insert.*

**ATTENTION :** *Pour éviter les choc électriques, introduire la lame la plug large de la borne correspondante de la prise et poussez jusqu'au fond.*

**FOR AUSTRALIA AND EUROPE.....220 V/230 V/240 V**

**FOR YOUR SAFETY**

Units shipped to Australia are designed for operation on 240 V AC only.

To ensure safe operation, the three-pin plug supplied must be inserted only into a standard three-pin power point which is effectively earthed through the normal household wiring. Extension cords used with the equipment must be three-core and be correctly wired to provide connection to earth. Improper extension cords are a major cause of fatalities. The fact that the equipment operates satisfactorily does not imply that the power point is earthed and that the installation is completely safe. For your safety, if in any doubt about the effective earthing of the power point, consult a qualified electrician.

**PAN-EUROPEAN UNIFIED VOLTAGE**

All units are suitable for use on supplies 220-240 V AC.

**FOR YOUR SAFETY**

Units shipped to countries other than the above countries are equipped with an AC voltage selector switch on the rear panel. Refer to the following paragraph for the proper setting of this switch.

**AC VOLTAGE SELECTION**

This unit operates on 110-220 V AC. The AC voltage selector switches on the rear panel are set to the voltage that prevails in the area to which the unit is shipped. Before connecting the power cord to your AC outlet, make sure that the setting position of these switches match your line voltage. If not, they must be set to your voltage in accordance with the following direction.

AC voltage selector switches

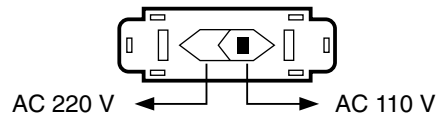

Move switch levers to match your line voltage with a small screwdriver or other pointed tool.

# System Connections

- Do not connect the receiver to the wall AC outlet when plugging and unplugging connection cords.
- Be sure to connect the white plugs to the L (left) and the red plugs to the R (right) jacks when making connections.
- Change the position of the FM indoor antenna until you get the best reception of your favorite FM stations.
- A 75 Ω outdoor FM antenna may be used to further improve the reception.  
Disconnect the indoor antenna before replacing it with the outdoor one.
- Place the AM loop antenna as far as possible from the receiver, TV set, speaker cords and the AC input cord and set it to a direction for the best reception.
- If the reception is poor with the AM loop antenna, an AM outdoor antenna can be used with the AM loop antenna.
- Make connections firmly and correctly. If not, it can cause loss of sound, noise or damage to the receiver.
- If the electricity fails or the AC input cord is left unplugged for about 2 weeks, the memorized contents will be cleared. So you should memorize them again.

## CONNECTING ANTENNAS

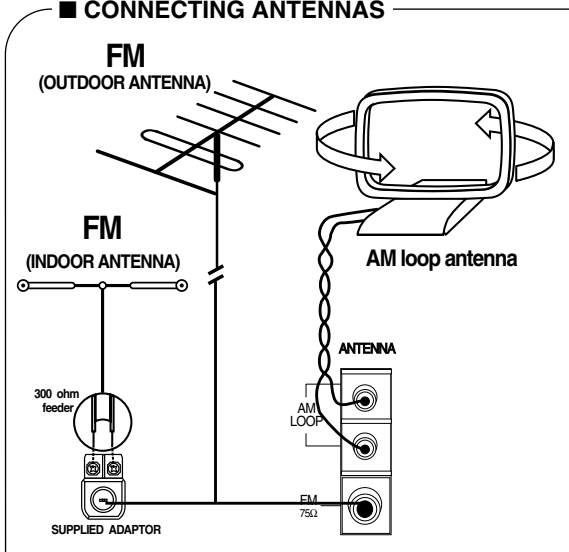

## CONNECTING VIDEO COMPONENTS

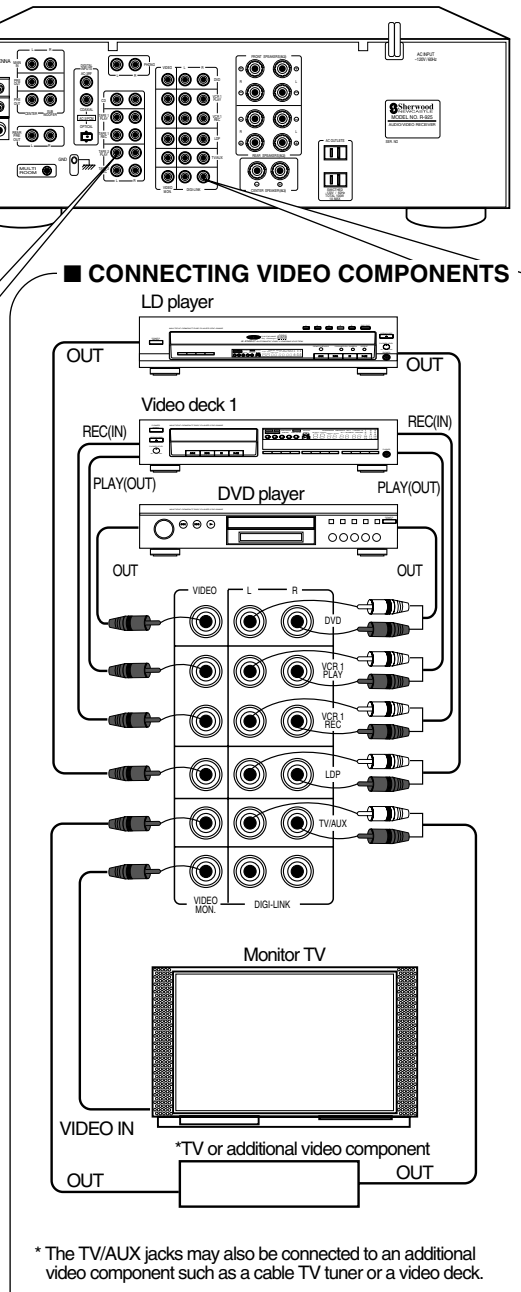

## CONNECTING AUDIO COMPONENTS

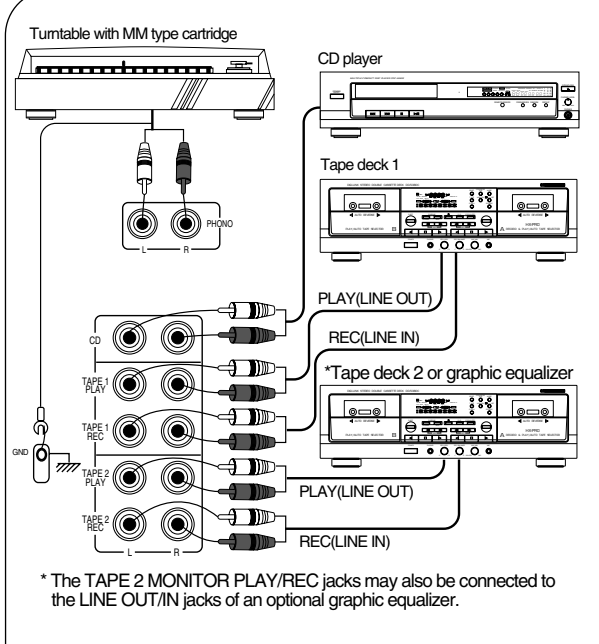

\* The TV/AUX jacks may also be connected to an additional video component such as a cable TV tuner or a video deck.

**CONNECTING MULTI- ROOM ADAPTOR**

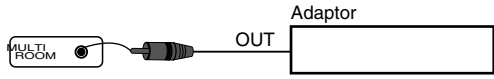

Connect this jack to the output of the multi-room adaptor. For information on the multi-room adaptor, contact the Xantech corporation at 1-800-843-5465.

**CONNECTING DIGITAL INPUTS**

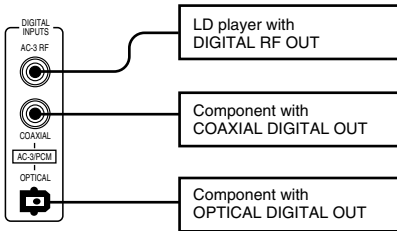

- A digital input should be connected to the components such as LD player or DVD, etc. capable of outputting Dolby AC-3, PCM or RF format digital signals.
- For details, refer to the operating instructions of the component connected.

**CONNECTING SYSTEM CONTROL**

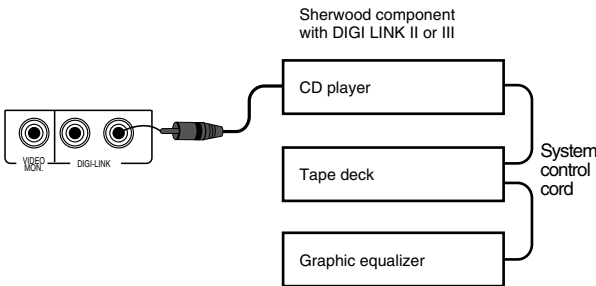

- Connect this jack to the DIGI LINK jack of the external Sherwood component that uses the DIGI LINK II or III remote control system.

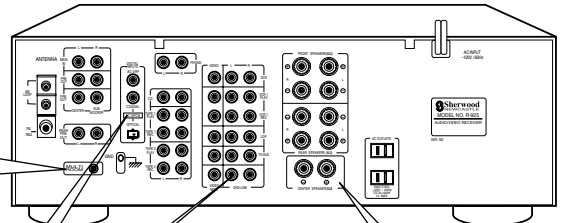

**CONNECTING SPEAKERS**

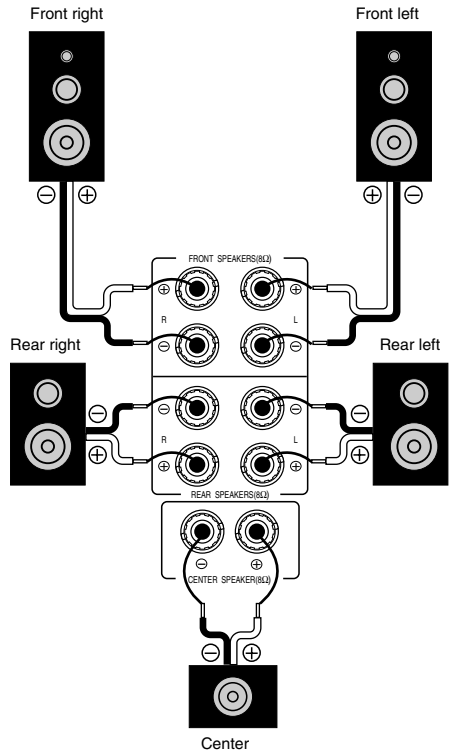

- Never short circuit the + and - speaker cords.
- Be sure to connect speakers firmly and correctly according to the channel (left and right) and the polarity (+ and -).
- Be sure to use the speakers with the impedance of over 8 Ω.
- Always connect both rear speakers.
- For installing the speakers, refer to "Speaker placement" on page 13.

■ MAIN IN connections

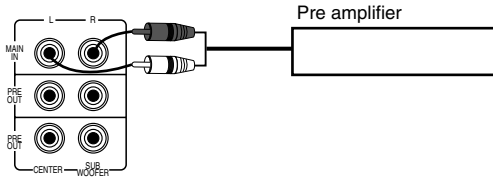

- When a separate pre amplifier is used for front channels, connect these jacks to the pre amplifier and connect the front speakers to this receiver.

■ AC INPUT CORD

Plug this cord into a wall AC outlet

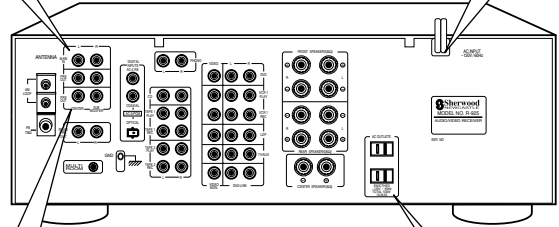

■ PRE OUT connections

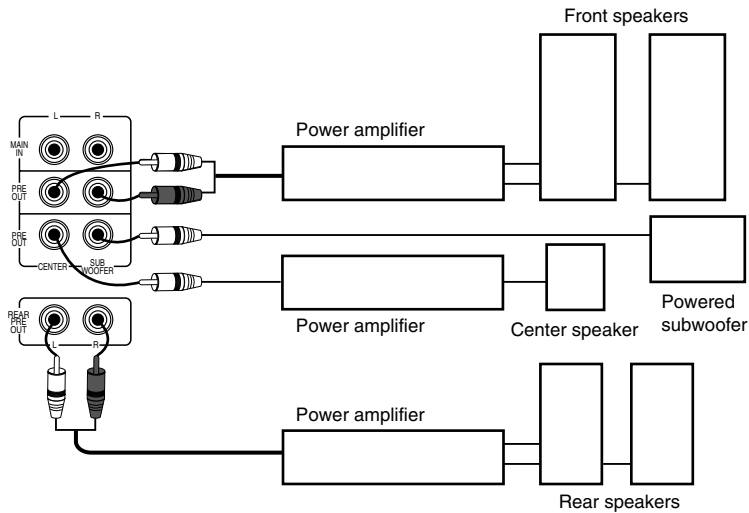

- Use these jacks if you want to listen at even higher volume levels.
- Connect the PRE OUT jacks to the powered speakers or the power amplifiers connected to speakers respectively.
- To emphasize the deep bass sounds, connect a subwoofer.
- When you do not use the front MAIN IN and PRE OUT jacks, always connect these jacks with the supplied jumper plugs.

■ SWITCHED AC OUTLET

- These outlets are switched on and off by the POWER button on the front panel or on the remote control. (Maximum total capacity is 1 A or 100W)

[ Standby mode – switched AC outlet off ]  
 [ Power on mode – switched AC outlet on ]

# Front Panel Controls

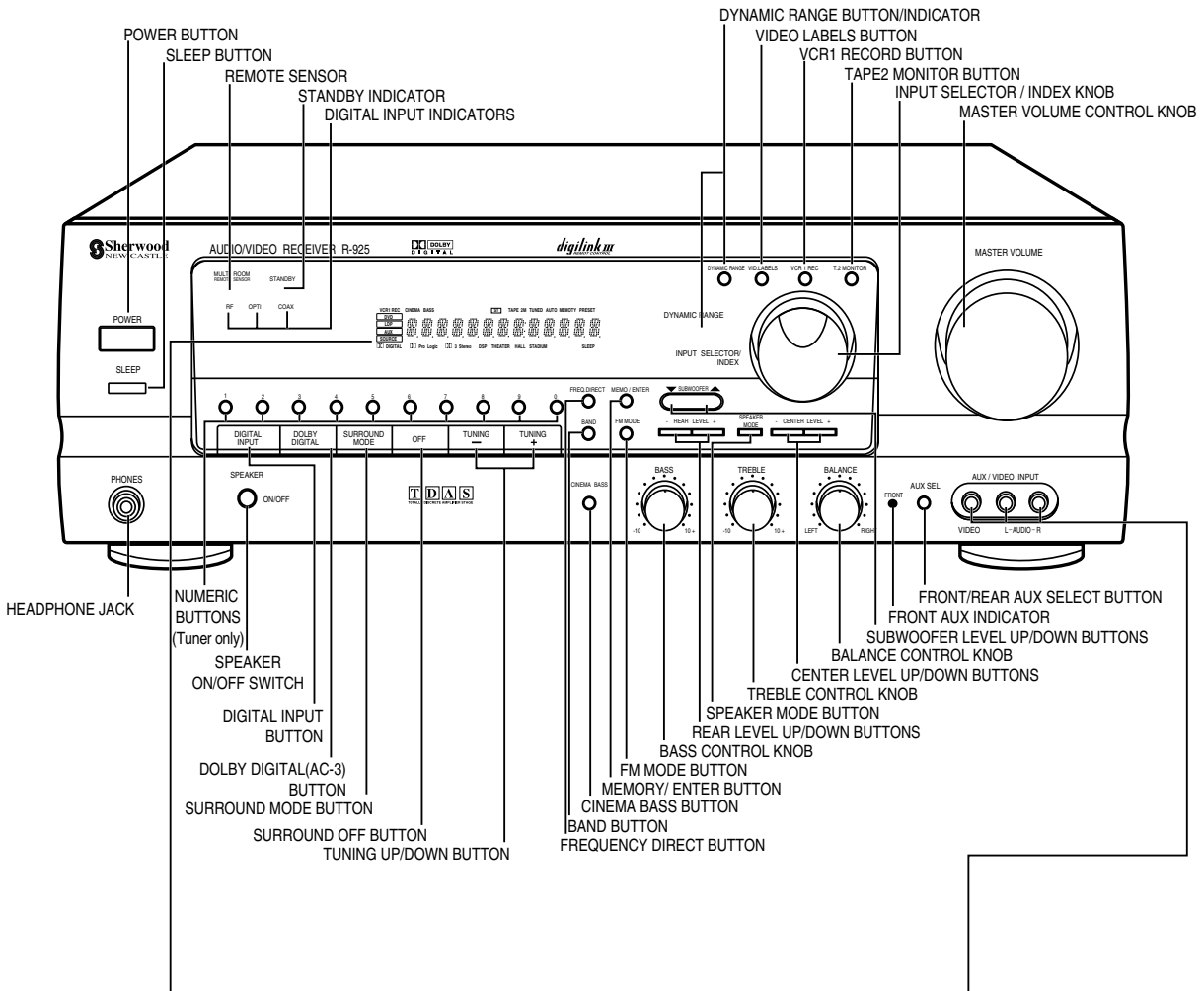

## FLUORESCENT DISPLAY

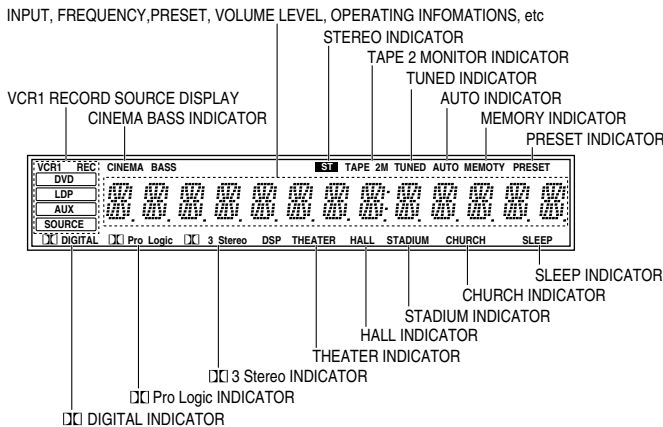

## AUX/VIDEO INPUT JACKS

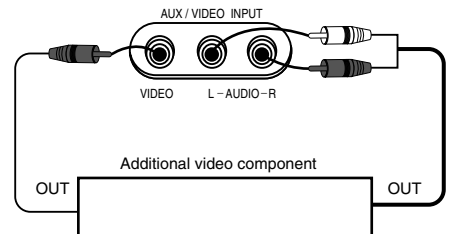

\* The AUX/VIDEO jacks may be also connected to an additional video component such as a camcorder, a video deck or a video game player, etc.

# DIGI LINK III System Remote controls

Note : In the United States, the R-925 is shipped with a Universal Illuminated Pre-programmed Remote Control(RNC-100).  
 When using this manual for instructions that require pressing buttons on the remote control, it will be necessary to press different buttons than those shown here.  
 Please see the owner`s manual supplied with the remote for the corresponding buttons.

- You can remotely control not only this receiver but also Sherwood compatible components bearing the DIGI LINK II or III logo.
- For system remote control operation, first make the DIGI LINK connections.

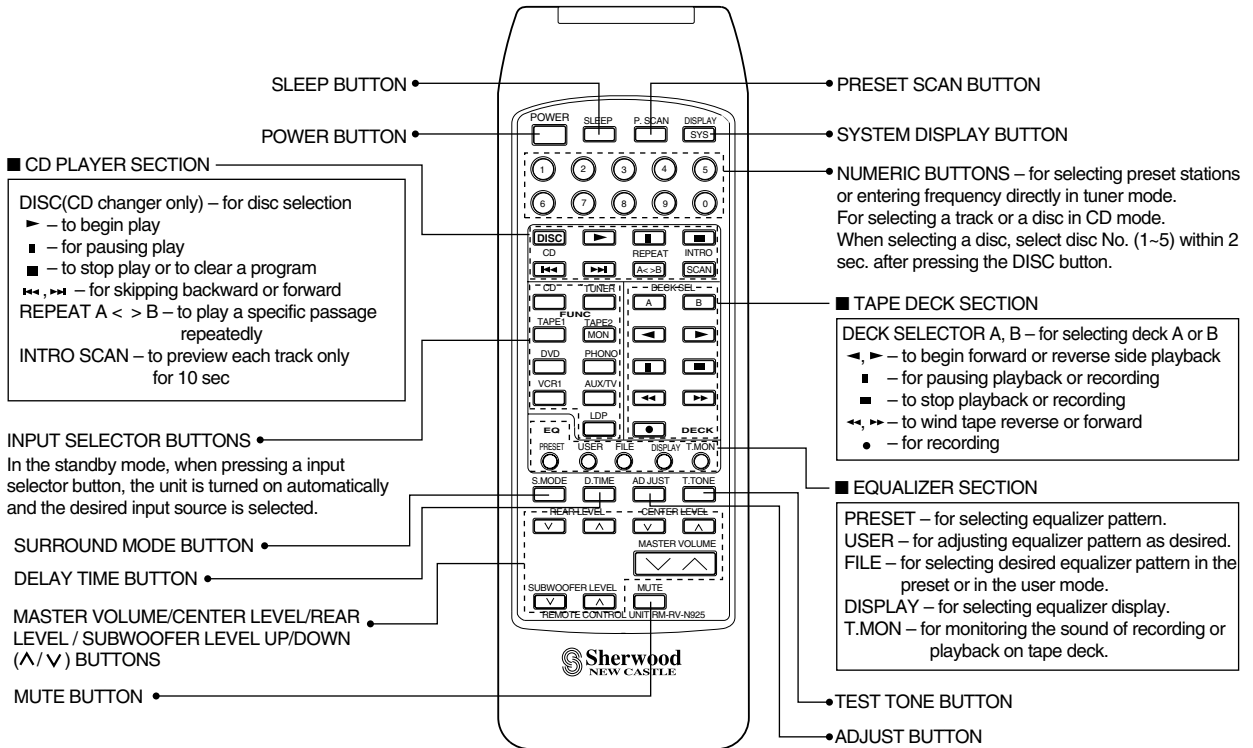

- In the DIGI LINK III remote control system, if pressing PLAY,etc. on CD player or tape deck, CD or TAPE 2 MONITOR is selected automatically without selecting the input source and then PLAY,etc. starts.  
 In this case,to listen to TAPE 1, switch off the TAPE 2 MONITOR and select the TAPE 1.

Notes:

- Some functions for CD player, tape deck or equalizer may not be available.
- For details about functions, refer to the operating instructions of each component.



# REMOTE CONTROL OPERATION RANGE

The diagram shows a Sherwood AUDIOVIDEO RECEIVER R-925. A sensor on the front panel is shown with a conical beam extending downwards. The beam has a radius of 30 degrees on both sides, creating a total angle of 60 degrees. The distance from the sensor to the remote control is labeled as 7 meters. The remote control is shown vertically below the beam.

- Use the remote control unit within a range of about 7 meters (23 feet) and angles of up to 30 degrees aiming of the remote sensor.

# LOADING BATTERIES

1. Remove the cover.

The diagram shows the back of the remote control. A small rectangular cover is being lifted away from the battery compartment. A black arrow points to the cover, and another arrow points to the opening of the battery compartment.

2. Load two batteries matching the polarity.

The diagram shows two AA batteries standing upright. To the right, a battery compartment is shown with two slots. The top slot has a '+' sign and the bottom slot has a '-' sign. The two batteries are shown inserted into these slots, matching the polarity.

2 x 1.5V  
R6/SUM-3/AA

- Remove the batteries when they are not used for a long time.
- Do not use the rechargeable batteries(Ni-Cd type).

# Operations

Note : In the United States, the R-925 is shipped with a Universal Illuminated Pre-programmed Remote Control(RNC-100). When using this manual for instructions that require pressing buttons on the remote control, it will be necessary to press different buttons than those shown here. Please see the owner's manual supplied with the remote for the corresponding buttons.

## LISTENING TO A PROGRAM SOURCE

**1** Turn the power on.

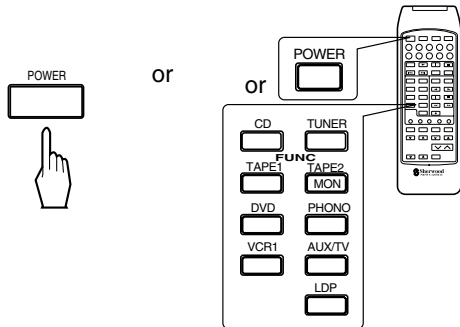

- Each time the POWER button is pressed, the receiver is turned on to enter the operating mode or off to enter the standby mode.
- In the standby mode, if the INPUT SELECTOR button is pressed on the remote control, the receiver is turned on automatically and the desired input is selected.
- In the standby mode, the STANDBY indicator lights up. This means that the receiver is not disconnected from the AC mains and a small amount of current is retained to support the memorized contents and operation readiness.

**2** Switch the speakers on.



- Then sound can be heard from the speakers connected to the speaker terminals.
- When using the headphone for private listening, press the SPEAKER switch again to switch the speakers off.

**3** Select the desired input source.

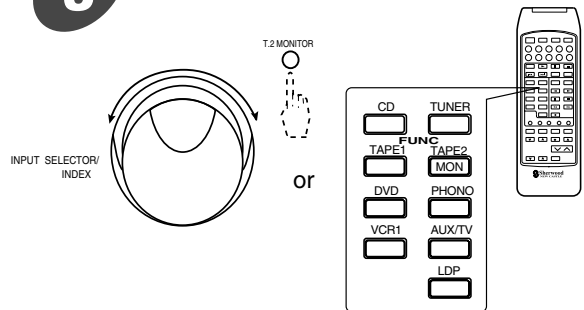

- Each time the INPUT SELECTOR/INDEX knob is rotated, the input source changes as follows :  
 PHONO ↔ TUNER ↔ CD PLAYER ↔ TAPE 1  
 (frequency display)  
 AUX/TV ↔ VCR1 ↔ LD PLAYER ↔ DVD
- When the TAPE 2 MONITOR button is set to on so that "TAPE 2M" indicator lights up, other inputs can not be heard from the speakers.  
 To listen to a input source other than TAPE 2 MONITOR, be sure to set the TAPE 2 MONITOR button to off.

### TAPE 2 MONITOR function

You can connect either a tape deck or a graphic equalizer to the receiver's TAPE 2 MONITOR jacks. Only when you listen to the component connected to these jacks, set the TAPE 2 MONITOR button to on. If you connect a 3-head tape deck, you can listen to the sound being recorded during recording, not the source sound.

For further details, refer to the operating instructions of the component connected.

### When the AUX/TV is selected as input source

- Select the front AUX/VIDEO or the rear TV/AUX.

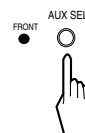

- If the front AUX/VIDEO is selected, the FRONT AUX indicator lights up.

**When CD, DVD, LDP or AUX/TV is selected as input source**

- Select the digital (or the analog) input connected as desired.
- Each time this button is pressed, the corresponding input is selected as follows;
  - In the normal stereo or a surround mode other than the Dolby DIGITAL(AC-3) mode.

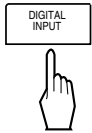

→ OPTICAL → COAXIAL → ANALOG →

– In the Dolby DIGITAL(AC-3) mode: Not available for CD

→ (RF:LDP only) → OPTICAL → COAXIAL →

- When the selected optical or coaxial digital input is not connected, the selected DIGITAL INPUT indicator is flickering, meaning no sound. (Refer to “Select the desired surround mode” on page 13)
- When DVD, LDP or AUX/TV is selected and the Dolby DIGITAL(AC-3) mode is selected, regardless of the input source selected, the Dolby DIGITAL(AC-3) program sources on the component connected to the selected digital input can be heard.

- 4** Operate the selected component for playback.
- When playing back the program sources with the surround sound, refer to “Enjoying surround sounds” on page 13.

- 5** Adjust the (overall) volume.

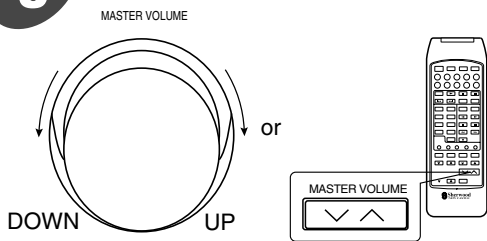

- 7** Adjust the stereo balance between the left and the right channels.

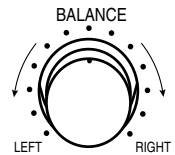

- 8** Adjust the subwoofer level.

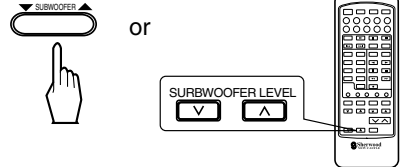

- It is adjustable only when the subwoofer is connected and the subwoofer is set to “YES”. (Refer to “Adjusting the speaker setting” on page 14 )

- 9** To enjoy the impressive bass sound.



- Press it again to cancel.

- 10** To mute the sound.

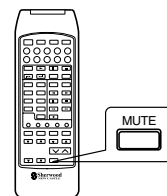

- The “MUTE” is flickering.
- To resume the previous sound level, press it again.

- 6** Adjust the tone (bass and treble).

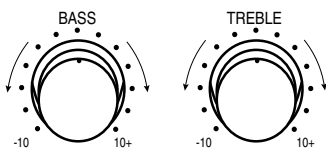

Note : Extreme settings at high volume may damage your speakers.

- 11** To listen with the headphones.



- Ensure that the SPEAKER ON/OFF switch is set to off.

## SURROUND SOUNDS

- The R-925 incorporates a sophisticated Digital Signal Processor that allows you to create the optimum sound quality and the sound atmosphere in your room.

### Surround modes

This receiver has 7 different surround modes to allow you to enjoy surround sound with the various program sources: DOLBY DIGITAL(AC-3), DOLBY PRO LOGIC, DOLBY 3 STEREO, THEATER, HALL, STADIUM, CHURCH.

**DOLBY DIGITAL(AC-3)** : Allows you to enjoy up to 5.1 channels of digital surround sound from Dolby DIGITAL(AC-3) program sources bearing the “” trademark such as laser discs.

Dolby DIGITAL(AC-3) provides even better sound quality, improved dynamic range and great sense of direction, compared with the conventional Dolby surround. Now, you are able to enjoy real movies in your home.

**DOLBY PRO LOGIC** : This receiver incorporates the Dolby Pro Logic Surround Decoder which has the same functions for playback as movie theaters and gives a theater - like experience in your home, naturally reproducing the audio sound field. Use with Dolby Pro Logic program sources bearing the “” trademark such as video cassette tapes or laser discs.

**DOLBY 3 STEREO** : Combining the rear speaker signal with that of the front speakers allows you to enjoy a regenerated sound field which has comparatively more presence and a more expansive feeling from the 3 front channels (front L, front R and center speakers) than that of ordinary stereo regeneration. Use with Dolby program sources bearing the “” trademark.

**THEATER** : This mode provides the effect of being in a movie theater when watching a movie sources that have a stereo sound track.

**HALL** : This mode provides the ambience of a concert hall for classical music sources such as orchestral, chamber music or an instrumental solo.

**STADIUM** : This mode provides the expansive sound field. For music sources like a rock concert, you will feel as if you were actually at the live concert. For sports programs such as a baseball game, you can enjoy a powerful sound, thus obtaining the true stadium effect.

**CHURCH**: This mode provides the ambience of a church for baroque, string orchestral and choral group music.

### Delay time

The sound heard in a place such as a concert hall or a movie theater consists of the direct sound that reaches our ears directly from the sound source and the reflected sound that is indirectly reflected off from walls, floor and ceiling. The reflected sound reaches our ears slightly later than the direct sound. The delay time is the time difference between the direct sound and the reflected sound. The optimum delay time will be different according to the room size and the acoustic properties. It is recommended that you try different times to obtain the best effect.

- It is adjustable in the Dolby DIGITAL(AC-3) and the Dolby Pro Logic modes only.

- Manufactured under license from Dolby Laboratories.

“Dolby”, “Pro Logic” and the double-D symbol are trademarks of Dolby Laboratories.

Confidential Unpublished Works. © 1992-1997 Dolby Laboratories, Inc. All rights reserved.

## Speaker placement

To obtain the best surround sound effect in your home, place the speakers as follows;

- Front speakers : Place each front speaker about 1m (40") from the TV set.
- Center speaker : Place the center speaker either above or below the TV set to assure good visualization of center channel program.
- Rear speakers : Place the rear speakers approximately 1m above the ear level of a seated listener on the direct left and right of them or slightly behind.
- Subwoofer : Reproduces powerful deep bass sounds. Place a powered subwoofer anywhere in the front as desired.
- The ideal surround system needs all the speakers listed above. However, if you don't have a center speaker, a subwoofer or rear speakers, select the best possible surround mode with the available speakers.

Note: To avoid interference with the TV picture, use only magnetically shielded center and front speakers.

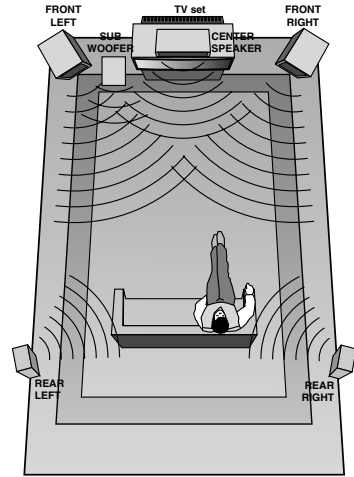

## ENJOYING SURROUND SOUNDS

- Surround sound effect will not work properly if the signal passes through a graphic equalizer. Please refer to your equalizer operating instructions for guidance on switching off (or defeating) the equalizer.

**1** Select the desired surround mode.

- When selecting the Dolby DIGITAL(AC-3) mode.

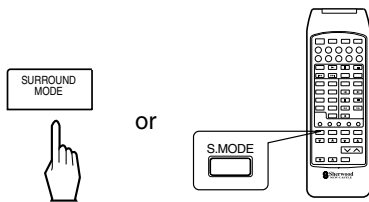

- The Dolby DIGITAL(AC-3) mode is available for the input sources such as DVD, LDP and AUX/TV only.
- To enjoy the Dolby DIGITAL(AC-3), be sure that the program source to be played back is the Dolby DIGITAL(AC-3) program source and the corresponding digital input is selected. If not, no sound will be heard.
- \* When LDP is selected, RF can be also selected among the digital inputs in the Dolby DIGITAL(AC-3) mode only. (Refer to "When CD, DVD, LDP or AUX/TV is selected as input source" on page 11.)

- When selecting a surround mode other than the Dolby DIGITAL(AC-3) mode.

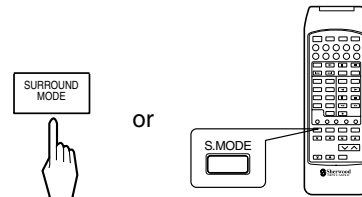

- Each time the SURROUND MODE button is pressed, the surround mode changes as follows;

→ [DIGITAL] → [Pro Logic] → [3 Stereo] → THEATER

(OFF) ← CHURCH ← STADIUM ← HALL ←

“( )”:Remote control only.

- When canceling the surround mode for normal stereo operation.

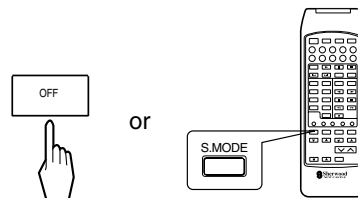

### Adjusting the speaker settings

- Adjusting the setting of the center speaker and the subwoofer connected.

**2** Press the SPEAKER MODE button for more than 2 seconds to enter the center speaker mode.

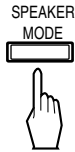

- In the THEATER, HALL, STADIUM, CHURCH or normal stereo mode, it will become the subwoofer mode directly.

**5** Select the desired subwoofer mode.

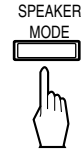

- Each time this button is pressed, the subwoofer mode changes and flickers as follows;

YES : When using a subwoofer.  
NO : When not using a subwoofer.

**3** Select the desired center speaker mode.

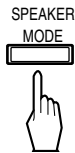

- Each time this button is pressed, the center speaker mode changes and flickers as follows;

LARGE : When using a relatively large center speaker.  
SMALL : When using a relatively small center speaker.  
NONE : When not using a center speaker.

- In the Dolby 3 Stereo mode, the NONE mode can not be selected.

**6** Memorize the desired subwoofer mode while it flickers.

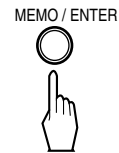

- If the subwoofer display goes off, repeat again from the above step 2.

**4** Memorize the desired center speaker mode while it flickers.

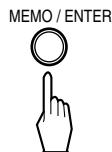

- The desired center speaker mode is memorized and then it becomes the subwoofer mode.
- If the center speaker display goes off, repeat again from the above step 2.

### Checking the speaker setting

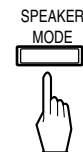

- Each time this button is pressed briefly, the setting of the center speaker or the subwoofer is displayed.

**In Dolby DIGITAL(AC-3), Dolby Pro Logic or Dolby 3 Stereo mode**

**7** Press the TEST TONE button to adjust the volume level of each speaker.

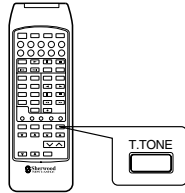

- Test tone will be heard from each speaker for 2 seconds each as follows;

→ FRONT L→CENTER→FRONT R→REAR R→REAR L→SUB

- The test tone will be heard from the subwoofer only when subwoofer is set to “YES” in the Dolby DIGITAL(AC-3) mode.
- Test tone is not heard from rear speakers in Dolby 3 Stereo mode.
- Test tone is not heard from center speaker when the center speaker setting is adjusted to the NONE mode.

**8** Adjust the volume levels of the speakers until they all sound equally loud.

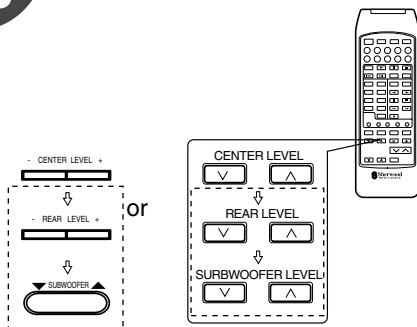

- The rear L and R volume levels are adjusted respectively during the test tone function and all together while enjoying surround sounds.

**9** Cancel the test tone function.

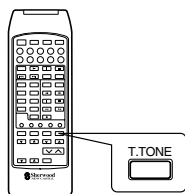

**10** Check the delay time to be adjusted.

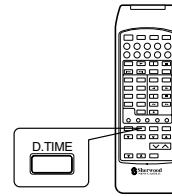

- The delay time will be displayed for 5 seconds.
- In Dolby DIGITAL(AC-3) mode, the corresponding delay time will be flickering.
- The center delay time can be adjustable only in Dolby DIGITAL(AC-3) mode.
- The rear delay time can be adjustable only in Dolby DIGITAL(AC-3) and Dolby Pro Logic modes.

**11** Adjust the delay time.

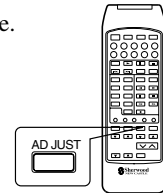

- Each time this button is pressed, the delay time changes in regular intervals.
- If the delay time disappears, start from the step 10 again.

**12** Memorize the delay time.

- In Dolby Pro Logic mode, the rear delay time can be memorized without pressing the DELAY TIME button.

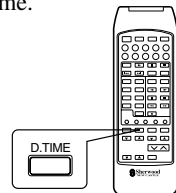

**13** In Dolby DIGITAL(AC-3) mode, repeat the above steps 11 and 12 to adjust the rear delay time.

**In THEATER, HALL, STADIUM or CHURCH Mode**

**7** Adjust the volume level of the rear speakers relative to that of the front speakers.

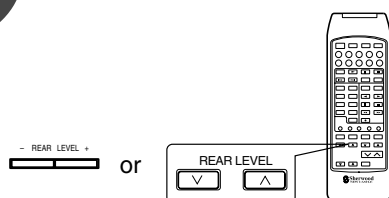

# LISTENING TO RADIO BROADCASTS

1

Select the tuner.

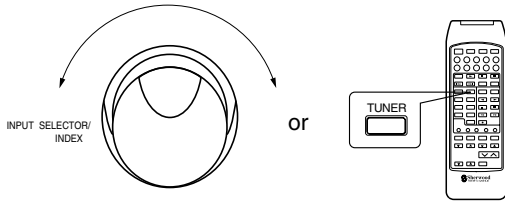

## Manual tuning

- Manual tuning is useful when you already know the frequency of the desired transmitter.

3

Press TUNING - or + repeatedly until the right frequency has been reached.

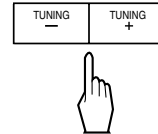

2

Select the desired band.

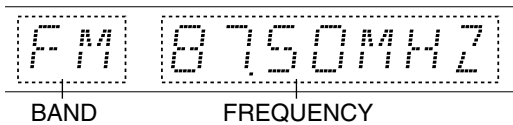

- Each time this button is pressed, the band is changed to FM or AM.
- When pressing the BAND button without selecting the TUNER, the tuner will be selected automatically and operate.

## Frequency direct tuning

3

Enter the frequency direct tuning mode.



## Auto tuning

3

Press TUNING - or + for more than 0.5 second.

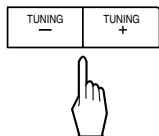

- Then AUTO appears on the display. The tuner will now search until a station of sufficient strength has been found. The display shows the tuned frequency and "TUNED".
- If the station found is not the desired one, simply repeat this operation.
- Weak stations are skipped during auto tuning.

4

Enter the frequency within 7 seconds for each digit.

Examples)

- FM 89.10MHz :
- FM 100.70 MHz :
- AM 890 kHz :
- AM 1030 kHz :

- In FM band, If "1" is pressed on the first digit, "10" is entered.
- With the numeric button on the remote control, you can also enter the frequency.
- In each digit, if it elapses 7 seconds, press the FREQUENCY DIRECT button again to enter the frequency.



### Presetting radio stations

- You can store up to 30 preferred stations in the memory.

**3** Tune in the desired station with auto or manual tuning, etc.

**4** Press the MEMORY/ENTER button.



- “MEMORY” is flickering for 5 seconds.

**5** Enter a preset number (1~30).

Examples)

- For “3” :

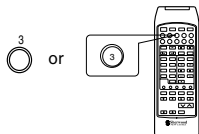

- For “15” :

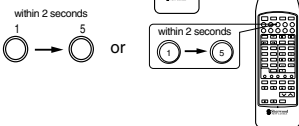

- The station has now been stored in the memory
- A stored frequency is erased from the memory by storing another frequency in its place.
- If “MEMORY” goes off, press the MEMORY/ENTER button again to enter a preset number.

### Tuning to preset stations

**2** Press the desired preset number.

Example)

- For “3” :

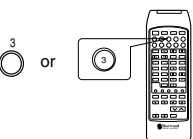

- For “15” :

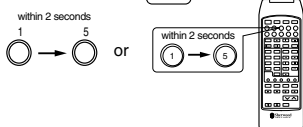

- When pressing the numeric buttons on the front panel without selecting the TUNER, the tuner will be selected automatically and the preset station will be tuned in.

### Listening to FM stereo broadcasts

- While listening to FM broadcasts.



- Each time this button is pressed, the FM mode changes as follows;

→ Stereo mode : “ST” lights up ←  
 → Mono mode : “ST” goes off ←

- When FM stereo broadcasts are poor because of weak broadcast signals, select the FM mono mode to reduce the noise, then FM broadcasts are reproduced in monaural sound

### Scanning preset stations in sequence

**1**

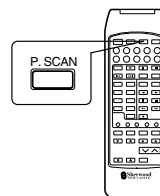

- The receiver will start scanning the stations in the preset sequence and each station is received for 5 seconds.

**2** At the desired station, press this button again to stop scanning.

### ■ MEMORY BACKUP FUNCTION

The following items, set before the receiver is turned off, are memorized.

If the electricity fails or the AC input cord is disconnected for about 2 weeks, they are all cleared. So you should memorize them again.

- INPUT SELECTOR settings
- VCR 1 RECORD settings
- Surround mode settings
- Preset stations
- Video labels, etc.

# AUDIO RECORDING

- The digital signals from optical, coaxial or RF digital input can be heard but cannot be recorded.

## Recording with TAPE 1

- Select the desired input as recording source except for TAPE1 and TAPE 2 MONITOR.

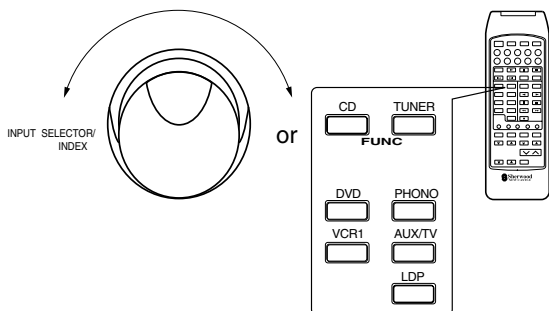

- Be sure that the TAPE 2 MONITOR indicator goes off.

- Start recording on the TAPE 1.

## Recording with TAPE 2 MONITOR

- Select the desired input as recording source except for TAPE 2 MONITOR.

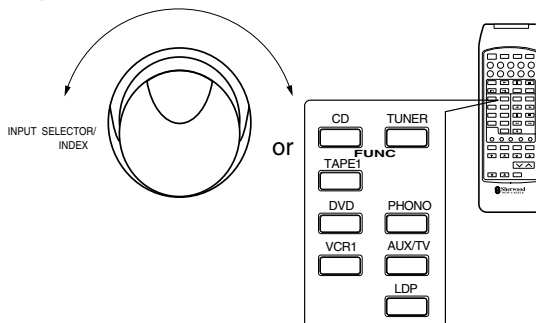

- Set the TAPE 2 MONITOR button to on.

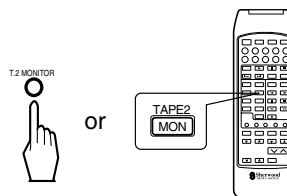

- Start play on the desired input.

- Start recording on the TAPE 2 MONITOR.

- Start play on the desired input.

- When the TAPE 1 is selected as recording source, dubbing will start from TAPE 1 to TAPE 2 MONITOR.
- It is not possible to dub from TAPE 2 MONITOR to TAPE 1.
- For tape 2 monitor function, refer to "TAPE 2 MONITOR function" on page 10.

# RECORDING WITH VCR1

- The digital signals from optical, coaxial or RF digital input can be heard but cannot be recorded.

## Dubbing from video components to VCR 1

Example) When dubbing from LD player to VCR 1

- 1 Select LDP as program source being enjoyed.

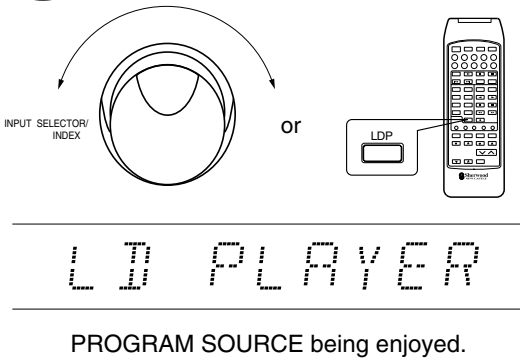

## Listening to other audio inputs during dubbing

Example) When listening to CD during dubbing from LDP to VCR 1.

- 1 Select CD as the program source being enjoyed.

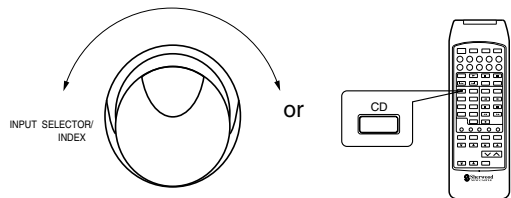

- 2 Select LDP as recording source.

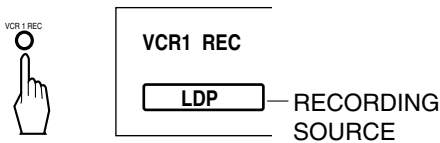

- Each time this button is pressed, the recording source changes as follows;

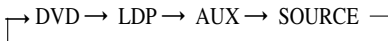

- 2 Select LDP as recording source.



- 3 Start recording on the VCR 1.

- 3 Start recording on the VCR 1.

- 4 Start play on the LDP.

- 4 Start play on the LDP.

- The audio and video signals from LDP will be dubbed onto the tape in VCR 1 and you can enjoy LDP on the TV set and from the speakers.

- 5 Start play on the CDP.

- The audio and video signals from LDP will be dubbed onto the tape in VCR 1 and you can listen to CD.

### Enjoying other video inputs during dubbing

Example) When enjoying DVD on the TV set and from the speakers during dubbing from LDP to VCR 1.

**1** Select DVD as the program source being enjoyed.

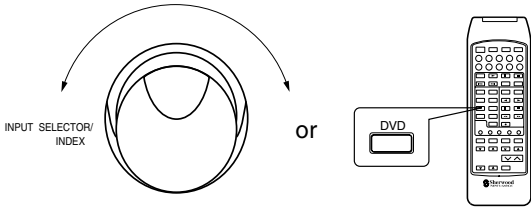

**2** Select LDP as recording source.



**3** Start recording on the VCR 1.

**4** Start play on the LDP.

**5** Start play on the DVD.

- The audio and video signals from LDP will be dubbed onto the tape in VCR 1 and you can enjoy DVD.

### Dubbing and enjoying the audio and video signals separately

Example) When dubbing and enjoying LD video signal and CD audio signal.

**1** Select source.



**2** Select LDP as video source within 5 seconds.

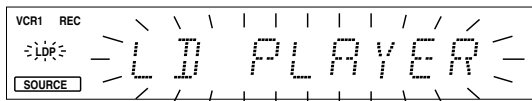
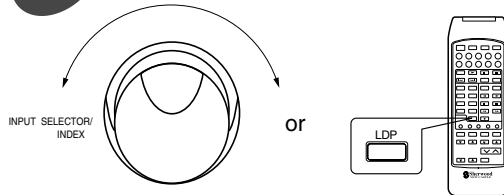

**3** Memorize it within 5 seconds.



**4** Select CD as audio source within 5 seconds.

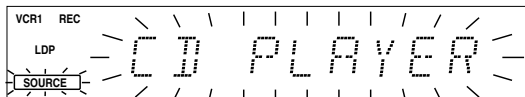
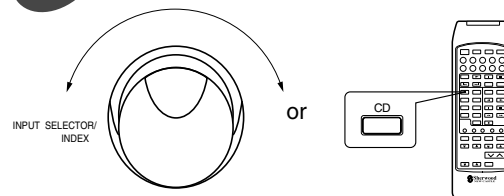

**5**

Memorize it within 5 seconds.

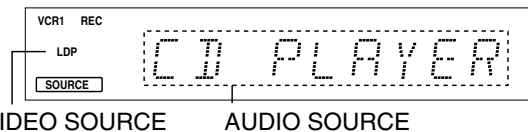

- In the above step, if it elapses 5 seconds, repeat again from the step 1.

**6**

Start recording on the VCR 1.

**7**

Start play on the LDP.

**8**

Start play on the CDP.

- The audio signal from CDP and the video signal from LDP will be dubbed onto the tape in VCR 1 and you can enjoy them on TV set and from the speakers.

## OTHER FUNCTIONS

### Compressing the dynamic range (Dolby DIGITAL(AC-3) mode only)

- This function compresses the dynamic range of previously specified parts of the Dolby DIGITAL(AC-3) sound track(with extremely high volume) to minimize the difference in volume between the specified and non-specified parts. This makes it easy to hear all of the sound track when watching movies at night at low levels.



- Then the DYNAMIC RANGE indicator lights up.
- Press again to cancel.
- In some Dolby DIGITAL(AC-3) softwares, this function may not be used.

### Operating the sleep timer

- The sleep timer allows the system to continue to operate for a specified period of time before automatically shutting off.
- To set the receiver to automatically turn off after the specified period of time.

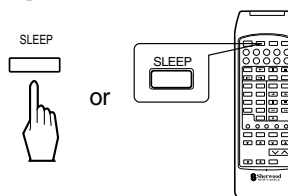

- Each time this button is pressed, the sleep time changes as follows ;

→10→20→30→60→90→OFF  
Unit : Minutes

- When the sleep time is selected, all display panels of Sherwood components connected by the DIGILINK III are dimly lit.

### Checking the brightness of the fluorescent displays

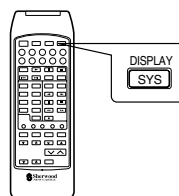

- Each time this button is pressed, the brightness of all fluorescent displays of Sherwood components connected by the DIGI LINK III changes together as follows;

→ ON → dim → OFF

- In the display OFF mode, when any button is pressed, the receiver switches to the display ON mode.

### Entering video labels

- It can be operated only on video input sources such as DVD, LDP, VCR 1 and AUX/TV.

**1** Select the desired video input source to enter its label.

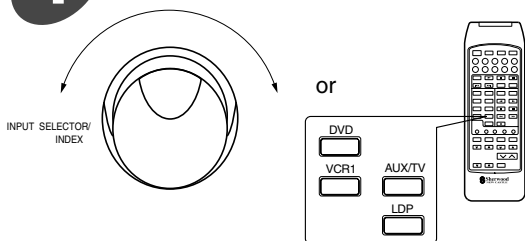

**2** Press the VIDEO LABELS button for more than 2 seconds.



**3** Select the first character of the video label while the digit is flickering.

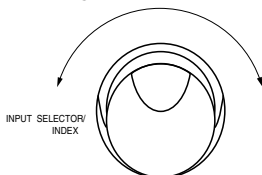

- Each time the INPUT SELECTOR/INDEX knob is rotated, the characters which can be selected are total 45 as follows ;

26 Capital Letters : A B C D E F G H I J K L M N O P  
Q R S T U V W X Y Z

10 Arabic Numerals : 1 2 3 4 5 6 7 8 9 0

9 Special Marks : ' < > \* + , - / \

**4** Memorize it within 6 seconds.



- If the MEMORY/ENTER button is pressed for more than 2 seconds on the character, a dot ( · ) will appear by the character.
- If the MEMORY/ENTER button is pressed without selecting the desired character, the digit will be blank.
- If 6 seconds elapses, repeat again from the step 2.

**5**

Repeat the steps 3 and 4 to memorize the rest of up to 8 characters.

### Rectifying or clearing a video label

**1**

Select the desired video input source to be rectified or cleared.

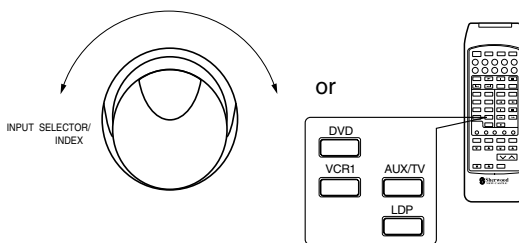

**2**

Repeat the steps 2~5 in “Entering video labels” procedure.

- To clear a video label, make a blank on each digit, then the video label is cleared and its video input source will be displayed.

### Checking the video components connected

- Use this function to check the video components connected to DVD, LDP, VCR 1 and AUX/TV jacks each.
- During play on the video components, press the VIDEO LABELS and the VCR 1 RECORD buttons simultaneously.

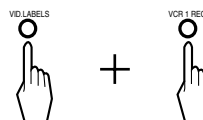

- The respective input source or its label scrolls on the display and you can check its video and audio contents in turn as follows;  
DVD → LD PLAYER → VCR 1 → AUX/TV FRONT → AUX/TV REAR
- During recording, do not check the video components connected.

# Troubleshooting Guide

If a fault occurs, run through the table below before taking your receiver for repair.

If the fault persists, attempt to solve it by switching the receiver off and on again. If this fails to resolve the situation, consult your dealer. Under no circumstances should you repair the receiver yourself as this will invalidate the guarantee!

PROBLEM	POSSIBLE CAUSE	REMEDY
No power	<ul style="list-style-type: none"> <li>The AC input cord is disconnected.</li> <li>Poor connection at AC wall outlet or the outlet is inactive.</li> </ul>	<ul style="list-style-type: none"> <li>Connect cord securely.</li> <li>Check the outlet using a lamp or another appliance.</li> </ul>
No sound	<ul style="list-style-type: none"> <li>The speaker cords are disconnected.</li> <li>The master volume is adjusted too low.</li> <li>The MUTE button is pressed to ON.</li> <li>Speakers are not switched on.</li> <li>The digital input is not selected correctly</li> <li>Incorrect selection of input source.</li> <li>Incorrect connections between the components.</li> </ul>	<ul style="list-style-type: none"> <li>Check the speaker connections.</li> <li>Adjust the master volume.</li> <li>Press the MUTE button to cancel the muting effect.</li> <li>Press the SPEAKER ON/OFF switch to ON.</li> <li>Select the digital input correctly.</li> <li>Select the desired input source correctly.</li> <li>Make connections correctly.</li> </ul>
No sound from the rear speakers	<ul style="list-style-type: none"> <li>Surround mode is switched off.</li> <li>Master volume and rear level are too low.</li> <li>Monaural source is used.</li> <li>Dolby 3 Stereo mode is selected.</li> </ul>	<ul style="list-style-type: none"> <li>Select a surround mode.</li> <li>Adjust master volume and rear level.</li> <li>Select a stereo or surround source.</li> <li>Select the desired surround mode.</li> </ul>
No sound from the center speaker	<ul style="list-style-type: none"> <li>Dolby DIGITAL(AC-3), Dolby Pro Logic or Dolby 3 Stereo mode is not selected.</li> <li>Master volume and center level are too low.</li> </ul>	<ul style="list-style-type: none"> <li>Select the desired surround mode.</li> <li>Adjust master volume and rear level.</li> </ul>
Stations cannot be received	<ul style="list-style-type: none"> <li>No antenna is connected.</li> <li>The desired station frequency is not tuned in.</li> <li>Antenna is in wrong position.</li> </ul>	<ul style="list-style-type: none"> <li>Connect an antenna.</li> <li>Tune in the desired station frequency.</li> <li>Move antenna and retry turning.</li> </ul>
Preset stations cannot be received	<ul style="list-style-type: none"> <li>An incorrect station frequency has been memorized.</li> <li>The memorized stations are cleared.</li> </ul>	<ul style="list-style-type: none"> <li>Memorize the correct station frequency.</li> <li>Memorize the stations again.</li> </ul>
Poor FM reception	<ul style="list-style-type: none"> <li>No antenna is connected.</li> <li>The antenna is not positioned for the best reception.</li> </ul>	<ul style="list-style-type: none"> <li>Connect an antenna.</li> <li>Change the position of the antenna.</li> </ul>
Continuous hissing noise during FM reception, especially when a stereo broadcast is received.	<ul style="list-style-type: none"> <li>Weak signals.</li> </ul>	<ul style="list-style-type: none"> <li>Change the position of the antenna.</li> <li>Install an outdoor antenna.</li> </ul>
Continuous or intermittent hissing noise during AM reception, especially at night.	<ul style="list-style-type: none"> <li>Noise is caused by motors, fluorescent lamps or lightning, etc.</li> </ul>	<ul style="list-style-type: none"> <li>Keep the receiver away from noise sources.</li> <li>Install an outdoor AM antenna.</li> </ul>
Remote control unit does not operate.	<ul style="list-style-type: none"> <li>Batteries are not loaded or exhausted.</li> <li>The remote sensor is obstructed.</li> </ul>	<ul style="list-style-type: none"> <li>Replace the batteries.</li> <li>Remove the obstacle.</li> </ul>
Other system components do not react to remote control commands.	<ul style="list-style-type: none"> <li>DIGI LINK connections are not made properly.</li> </ul>	<ul style="list-style-type: none"> <li>Make proper DIGI LINK connections.</li> </ul>

# Specifications

## ■ AMPLIFIER SECTION

- Power output, stereo mode, 8 Ω, THD 0.1%, 20 Hz~20 kHz.....2 × 100 W
- Total harmonic distortion, 8 Ω, 100 W, 1 kHz.....0.02 %
- Intermodulation distortion  
60 Hz: 7 kHz= 4:1 SMPTE, 8 Ω, 100 W .....0.02 %
- Input sensitivity, 47 kΩ  
Phono.....3.5 mV  
Line (CD, TAPE, VIDEO).....200 mV
- Signal to noise ratio, IHF "A" weighted  
Phono .....72 dB  
Line (CD, TAPE, VIDEO) .....95 dB
- Frequency response  
Line (CD, TAPE, VIDEO), 10 Hz~100 kHz.....+ 0 dB, -3 dB
- Output level  
TAPE REC, 2.2 kΩ .....200 mV  
PRE OUT(Front, center, rear, Subwoofer), 1 kΩ.....1 V
- Bass/Treble control, 100 Hz/10 kHz.....± 10 dB
- Surround mode, only channel driven  
Front power output, 8 Ω, 1 kHz.....2 × 100 W  
Center power output, 8 Ω, 1 kHz.....100 W  
Rear power output, 8 Ω, 1 kHz.....2 × 100 W

## ■ DIGITAL AUDIO SECTION

- Sampling frequency .....32,44.1,48 kHz
- Digital input level, 75 Ω  
Coaxial.....0.5 Vp-p

## ■ FM TUNER SECTION

- Tuning frequency range.....87.5~107.9 MHz
- Usable sensitivity, THD 3%, S/N 30 dB .....11.2 dBf
- 50 dB quieting sensitivity, mono/stereo .....15.2/38.2 dBf
- Signal to noise ratio, 65 dBf, mono/stereo.....80/73 dB
- Total harmonic distortion, 65 dBf, 1 kHz, mono/stereo.....0.15/0.25%
- Frequency response, 30 Hz~15 kHz .....± 1.5 dB
- Stereo separation, 1 kHz .....50 dB
- Capture ratio.....1.25 dB
- IF rejection ratio.....120 dB

## ■ AM TUNER SECTION

- Tuning frequency range .....520~1710 KHz
- Usable sensitivity, 400 mV/m .....12.5 mV
- Signal to noise ratio, 80 dB/m.....51 dB
- Selectivity.....30 dB

## ■ GENERAL

- Power supply .....AC 120 V, 60 Hz
- Power consumption.....4 A
- Switched AC outlet.....1 A or 100 W max.
- Dimensions (W × H × D).....440 × 140 × 380 mm(17-3/8 × 5-1/2 × 15 inches)
- Weight (Net).....15.5 kg(34.2 lbs)

Note: Design and specifications are subject to change without notice for improvements.



# O P E R A T I N G I N S T R U C T I O N S



**R-925**  
**AUDIO/VIDEO**  
**RECEIVER**

5707-04669-001-0  
(9007019040)

## Free Manuals Download Website

<http://myh66.com>

<http://usermanuals.us>

<http://www.somanuals.com>

<http://www.4manuals.cc>

<http://www.manual-lib.com>

<http://www.404manual.com>

<http://www.luxmanual.com>

<http://aubethermostatmanual.com>

Golf course search by state

<http://golfingnear.com>

Email search by domain

<http://emailbydomain.com>

Auto manuals search

<http://auto.somanuals.com>

TV manuals search

<http://tv.somanuals.com>