



OPERATING INSTRUCTIONS



RX-773



AM/FM 4CHANNEL STEREO RECEIVER

CE

Introduction

READ THIS BEFORE OPERATING YOUR UNIT

	CAUTION RISK OF ELECTRIC SHOCK DO NOT OPEN	
CAUTION : TO REDUCE THE RISK OF ELECTRIC SHOCK, DO NOT REMOVE COVER (OR BACK). NO USER-SERVICEABLE PARTS INSIDE. REFER SERVICING TO QUALIFIED SERVICE PERSONNEL.		

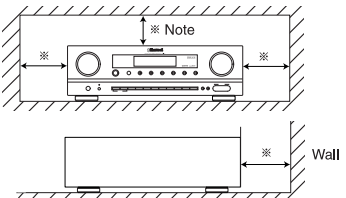

	This symbol is intended to alert the user to the presence of uninsulated "dangerous voltage" within the product's enclosure that may be of sufficient magnitude to constitute a risk of electric shock to persons.
	This symbol is intended to alert the user to the presence of important operating and maintenance (servicing) instructions in the literature accompanying the appliance.

WARNING : TO REDUCE THE RISK OF FIRE OR ELECTRIC SHOCK, DO NOT EXPOSE THIS APPLIANCE TO RAIN OR MOISTURE.

<p>Caution regarding installation Note : For heat dispersal, do not install this unit in a confined space such as a bookcase or similar enclosure.</p> <p>Do not block ventilation openings or stack other equipment on the top.</p>	
---	--

FOR YOUR SAFETY		
EUROPE AUSTRALIA	220 V - 240 V	<p>Units shipped to Australia are designed for operation on 230 V AC only.</p> <p>To ensure safe operation, the three-pin plug supplied must be inserted only into a standard three-pin power point which is effectively earthed through the normal household wiring. Extension cords used with the equipment must be three-core and be correctly wired to provide connection to earth. Improper extension cords are a major cause of fatalities. The fact that the equipment operates satisfactorily does not imply that the power point is earthed and that the installation is completely safe. For your safety, if in any doubt about the effective earthing of the power point, consult a qualified electrician.</p> <p>PAN-EUROPEAN UNIFIED VOLTAGE All units are suitable for use on supplies 220-240 V AC.</p>

CAUTION
<ul style="list-style-type: none"> • Leave a space around the unit for sufficient ventilation. • Avoid installation in extremely hot or cold locations, or in an area that is exposed to direct sunlight or heating equipment. • Keep the unit free from moisture, water, and dust. • Do not let foreign objects in the unit. • The ventilation should not be impeded by covering the ventilation openings with items, such as newspapers, table-cloths, curtains, etc. • No naked flame sources, such as lighted candles, should be placed on the unit. • Please be care the environmental aspects of battery disposal. • The unit shall not be exposed to dripping or splashing for use. • No objects filled with liquids, such as vases, shall be placed on the unit. • Do not let insecticides, benzene, and thinner come in contact with the set. • Never disassemble or modify the unit in any way. ■ Notes on the AC power cord and the wall outlet. • The unit is not disconnected from the AC power source(mains) as long as it is connected to the wall outlet, even if the unit has been turned off. • To completely disconnect this product from the mains, disconnect the plug from the wall socket outlet. • When setting up this product, make sure that the AC outlet you are using is easily acceptable. • Disconnect the plug from the wall outlet when not using the unit for long periods of time.

Information for Users on Collection and Disposal of Old Equipment and used Batteries
<div style="display: flex; align-items: center;">  <div style="margin-left: 10px;"> <p>These symbols on the products, packaging, and/or accompanying documents mean that used electrical and electronic products and batteries should not be mixed with general household waste. For proper treatment, recovery and recycling of old products and used batteries, please take them to applicable collection points, in accordance with your national legislation.</p> </div> </div>
<div style="display: flex; align-items: center;">  <div style="margin-left: 10px;"> <p>By disposing of these products and batteries correctly, you will help to save valuable resources and prevent any potential negative effects on human health and the environment which could otherwise arise from inappropriate waste handling.</p> </div> </div>
<div style="display: flex; align-items: center;">  <div style="margin-left: 10px;"> <p>For more information about collection and recycling of old products and batteries, please contact your local municipality, your waste disposal service or the point of sale where you purchased the items.</p> </div> </div>
<p>Pb</p>
<p>[Information on Disposal in other Countries outside the European Union] These symbols are only valid in the European Union. If you wish to discard these items, please contact your local authorities or dealer and ask for the correct method of disposal.</p> <p>Note for the battery symbol (bottom two symbol examples): The sign Pb below the symbol for batteries indicates that this batteries contains lead.</p>

CONTENTS

Introduction

- READ THIS BEFORE OPERATING YOUR UNIT 2

System Connections 4

Front Panel Controls 8

Universal Remote Controls 10

- OPERATING COMPONENTS WITH REMOTE CONTROL 12
- REMOTE CONTROL OPERATION RANGE 12
- LOADING BATTERIES 12
- USING FUNCTIONS OF REMOTE CONTROL 13

Operations

- LISTENING TO A PROGRAM SOURCE 16
- LISTENING TO RADIO BROADCASTS 19
- LISTENING TO RDS BROADCASTS(FM ONLY) 21
(RDS Tuner (Regional Option for some countries in Europe, etc))
- RECORDING 23
- OTHER FUNCTIONS 23
- ROOM2 PLAYBACK 24

Troubleshooting Guide 26

Specifications 27

Setup Code Table 28

System Connections

- Please be certain that this unit is unplugged from the AC outlet before making any connections.
- Be sure to observe the color coding when connecting audio, video and speaker cords.
- Make connections firmly and correctly. If not, it can cause loss of sound, noise or damage to the receiver.

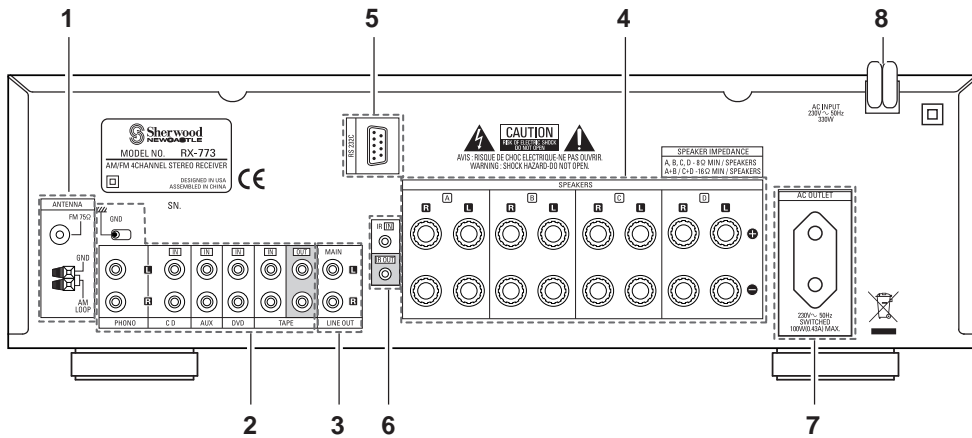

1. CONNECTING ANTENNAS

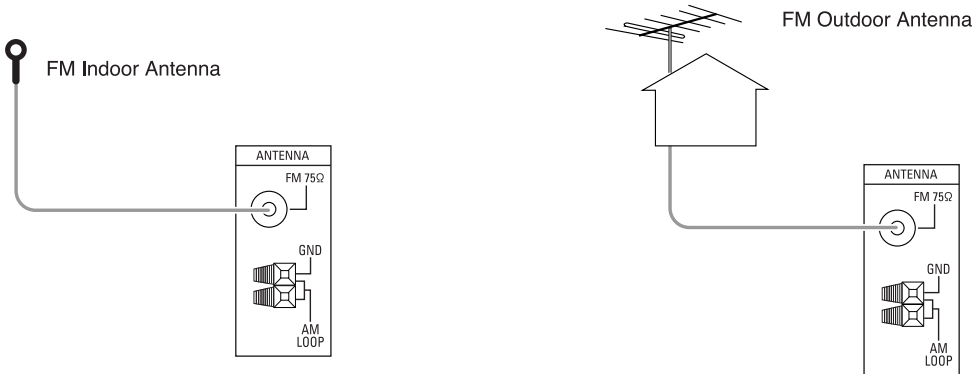

- Change the position of the FM indoor antenna until you get the best reception of your favorite FM stations.
- A 75Ω outdoor FM antenna may be used to further improve the reception. Disconnect the indoor antenna before replacing it with the outdoor one.

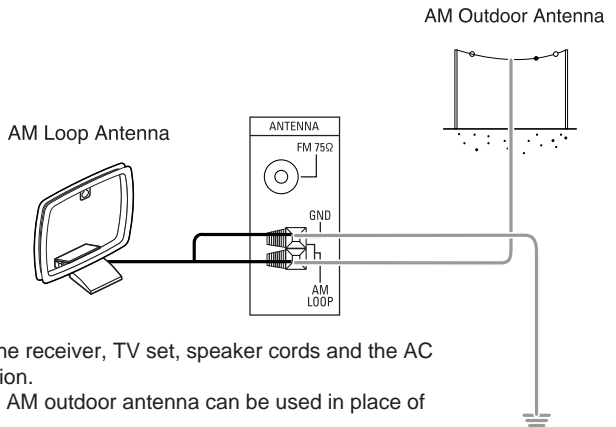
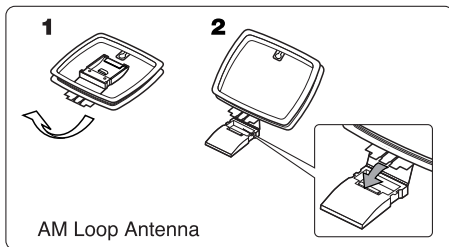

- Place the AM loop antenna as far as possible from the receiver, TV set, speaker cords and the AC input cord and set it to a direction for the best reception.
- If the reception is poor with the AM loop antenna, an AM outdoor antenna can be used in place of the AM loop antenna.

2. CONNECTING AUDIO COMPONENTS

- The AUX jacks may also be connected to an additional component.
 - The DVD jacks may be connected to AUDIO OUT jacks of video components such as DVD player, TV, etc.
 - The TAPE IN/OUT jacks can be connected to audio recording equipment such as a tape deck, an MD recorder, etc.
- **Note** : Do not connect the turntable with MC type cartridge directly. If so, use a separate head amplifier or step-up transformer.

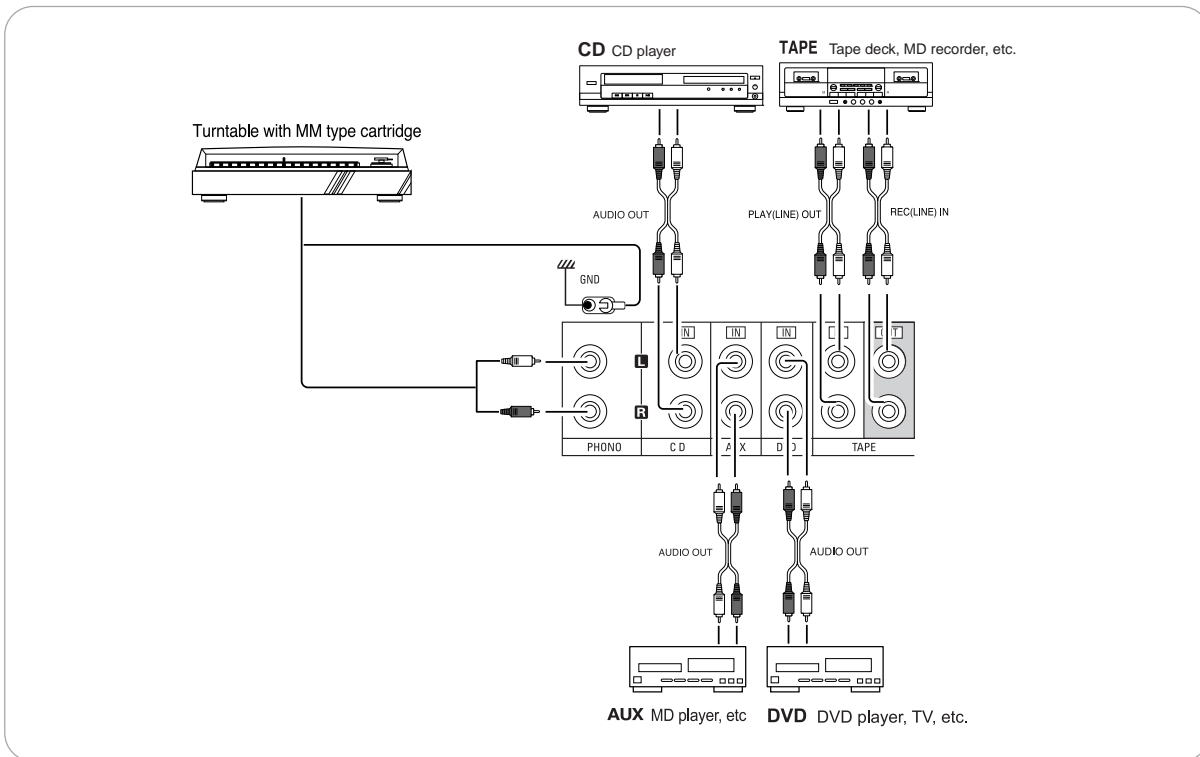

3. CONNECTING LINE OUTS

- The LINE OUT jacks can be connected to the amplifier in another room to allow you to play the same program source that is played in the main room
- **Note** : To minimize hum or noise, use high quality connection cord.

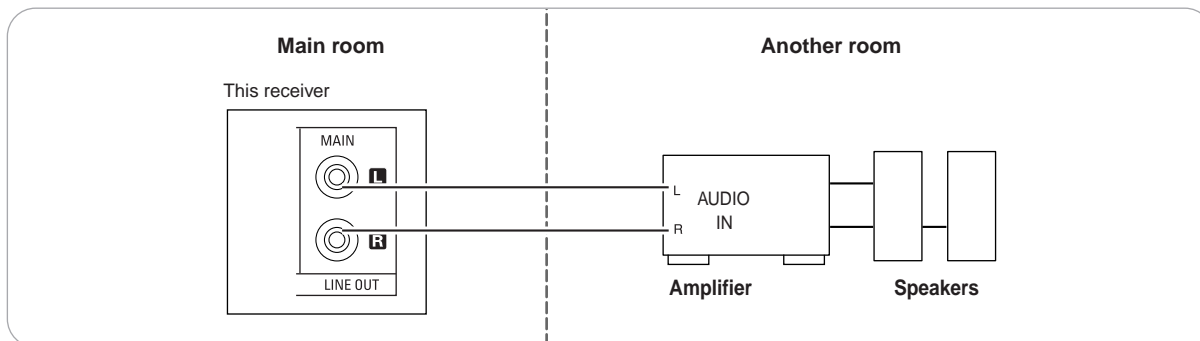

4. CONNECTING SPEAKERS

- You can connect up to four pairs of speakers to this receiver and select the various combinations of speakers according to your tastes.
- The speakers C and D can be installed in the main room as the speakers A and B can or in the another room (ROOM2) for ROOM2 playback. (For details, refer to "ROOM2 PLAYBACK" on page 24.)
- Be sure to connect speakers firmly and correctly according to the channel (left and right) and the polarity (+ and -).
- If the connections are faulty, no sound will be heard from the speakers, and if the polarity of the speaker connection is incorrect, the sound will be unnatural and lack bass.

■ Notes :

- For safe amplifier operation, use the speakers with impedance of over 8Ω when you connect a pair terminals of SPEAKER A and B terminals or/and a pair terminals of SPEAKER C and D terminals and use the speakers with impedance of over 16Ω when you connect both SPEAKER A and B terminals or/and both SPEAKER C and D terminals.
- Do not let the bare speaker wires touch each other or any metal part of this receiver. This could damage this receiver and/or the speakers.

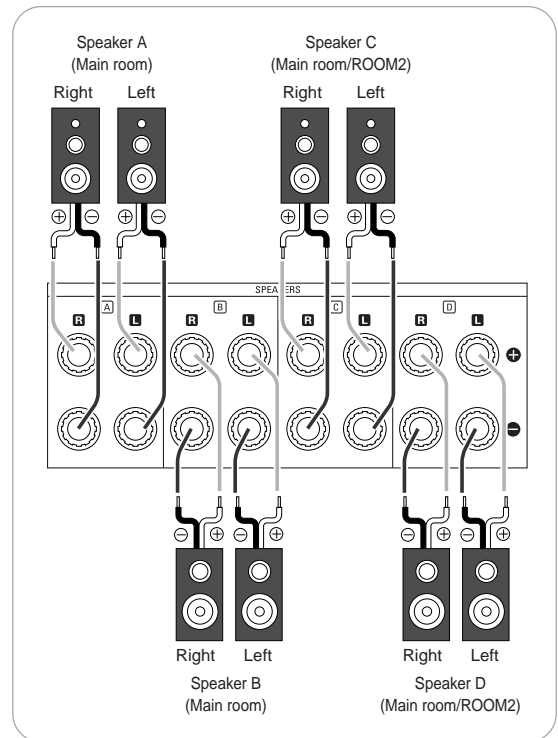

5. CONNECTING PC FOR UPGRADES

- This receiver incorporates RS-232C terminal that may be used in the future to update the operating software so that it will be able to support new digital audio formats, external control by using an external device and the like.

■ Notes:

- Programming for upgrades and external control requires specialized programming knowledge and for that reason we recommend that it only be done by qualified installers. For more information on future upgrades and external control, visit the Sherwood web site at www.sherwoodamerica.com or contact your dealer.
- Do not disconnect the connection cable while updating the operating software, etc. Should this happen, it may be result in malfunction or cause damage to the unit.

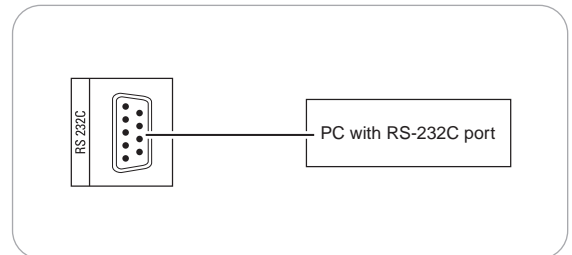

6. CONNECTING MULTI-ROOM SYSTEM KIT

- The multi-room system kit(sold separately) is essential for operation from a remote location .
For information on the multi-room system kit, contact the Xantech corporation at 1-800-843-5465 or www.xantech.com.
- IR IN jack allows you to control this receiver from another room with the remote control unit.
- To control this receiver from another room with the remote control unit, connect the IR IN jack to the output of the connecting block.
- If this receiver is located inside a cabinet or other enclosure where the infrared beams from the remote control unit cannot enter, then operation with the remote control unit will not be possible. In such a case, connect the IR IN jack to the output of the connecting block.
- To control other compatible component from another room with the universal remote control unit, connect the IR OUT jack to the output of the connecting block.
- **Note:** Remote operation may become unreliable if the IR receiver is exposed to strong light such as direct sunlight or inverted fluorescent.

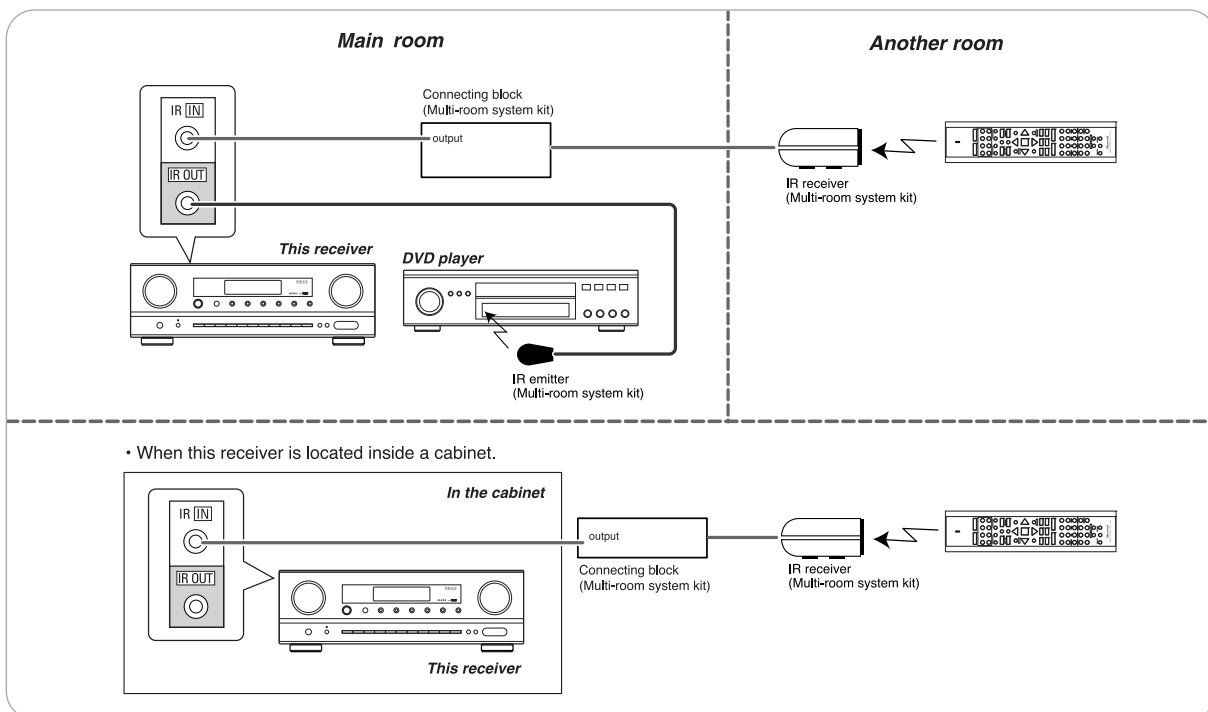

7. SWITCHED AC OUTLET

- This outlet is switched on (power-on mode) and off (standby mode) according to power control as follows (Maximum total capacity is 100 W (0.43A)).

Standby mode - Switched AC outlet off
 Power - on mode - Switched AC outlet on

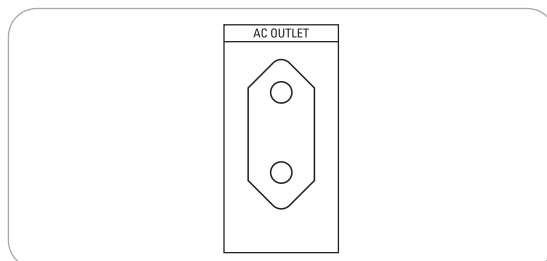

8. AC INPUT CORD

- Plug the cord into an wall AC outlet.

Front Panel Controls

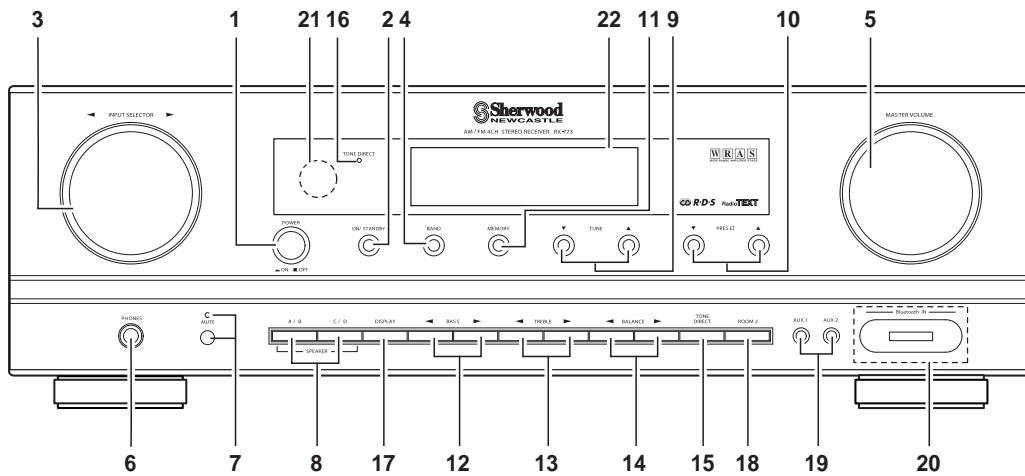

1. POWER switch
2. POWER ON/STANDBY button/indicator
3. INPUT SELECTOR knob
4. BAND button
5. MASTER VOLUME knob
6. HEADPHONE jack
7. MUTE button/indicator
8. SPEAKER A/B, C/D SELECTOR buttons
9. TUNING UP/DOWN(▲/▼) buttons
10. PRESET UP/DOWN(▲/▼) buttons
11. MEMORY button
12. BASS UP/DOWN (▶/◀) buttons
13. TREBLE UP/DOWN (▶/◀) buttons
14. BALANCE UP/DOWN (▶/◀) buttons
15. TONE DIRECT button
16. TONE DIRECT indicator
17. DISPLAY button
18. ROOM 2 button
19. AUX 1, 2 IN jacks
For details, see next page.
20. Bluetooth IN connector
For details, see next page.
21. REMOTE SENSOR
22. FLUORESCENT display
For details, see below.

■ FLUORESCENT DISPLAY

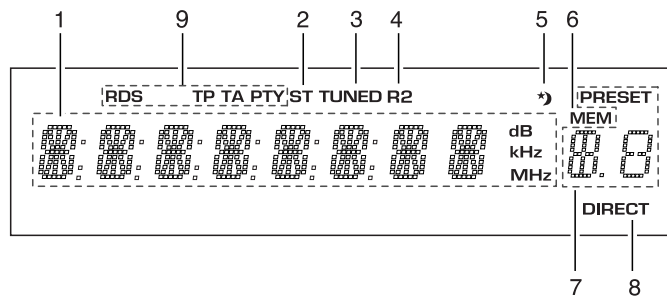

1. Input, frequency, volume level, operating information, etc.
2. STEREO indicator
3. TUNED indicator
4. ROOM2 indicator
5. SLEEP indicator
6. MEMORY indicator
7. Preset number, sleep time display
8. TONE DIRECT indicator
9. RDS indicators
(Regional option for Europe, etc.)

■ AUX 1, 2 IN JACKS

- The AUX 1, 2 IN jacks can be connected to additional audio components such as an MP3 player, etc.

■ Note :

- When connecting these jacks to an MP3 player, etc., you should use the stereo mini cord, not a mono mini cord.

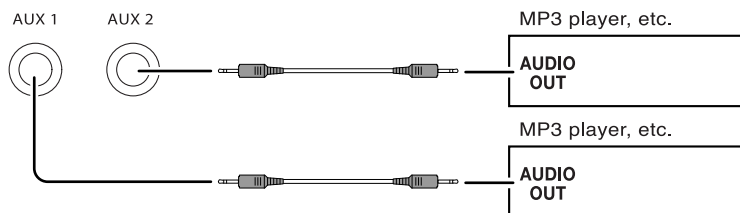

■ Bluetooth IN CONNECTOR

- If the **Bluetooth IN** connector is connected to Sherwood Audio Receiver BT-R7 (sold separately) with *Bluetooth* wireless technology, you can enjoy music wirelessly with a music player featuring *Bluetooth* wireless technology such as MP3 player, mobile phone, etc..

(For information on Sherwood Audio Receiver BT-R7, contact your dealer.)

- The *Bluetooth* word mark and logos are registered trademarks owned by Bluetooth SIG, Inc. and any use of such marks by Sherwood is under license. Other trademarks and trade names are those of their respective owners.

■ Note :

- For safe operation, turn the power off before connecting or disconnecting the Audio Receiver BT-R7.

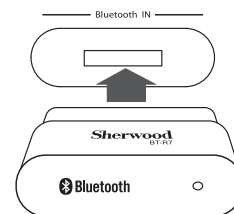

Universal Remote Controls

This universal remote control can operate not only this receiver but also most popular brands of audio and video components such as CD players, tape decks, TVs, cable boxes, VCRs, DVD players, satellite receivers, etc.

- To operate 7 components other than this receiver, you should enter the setup code for each component.







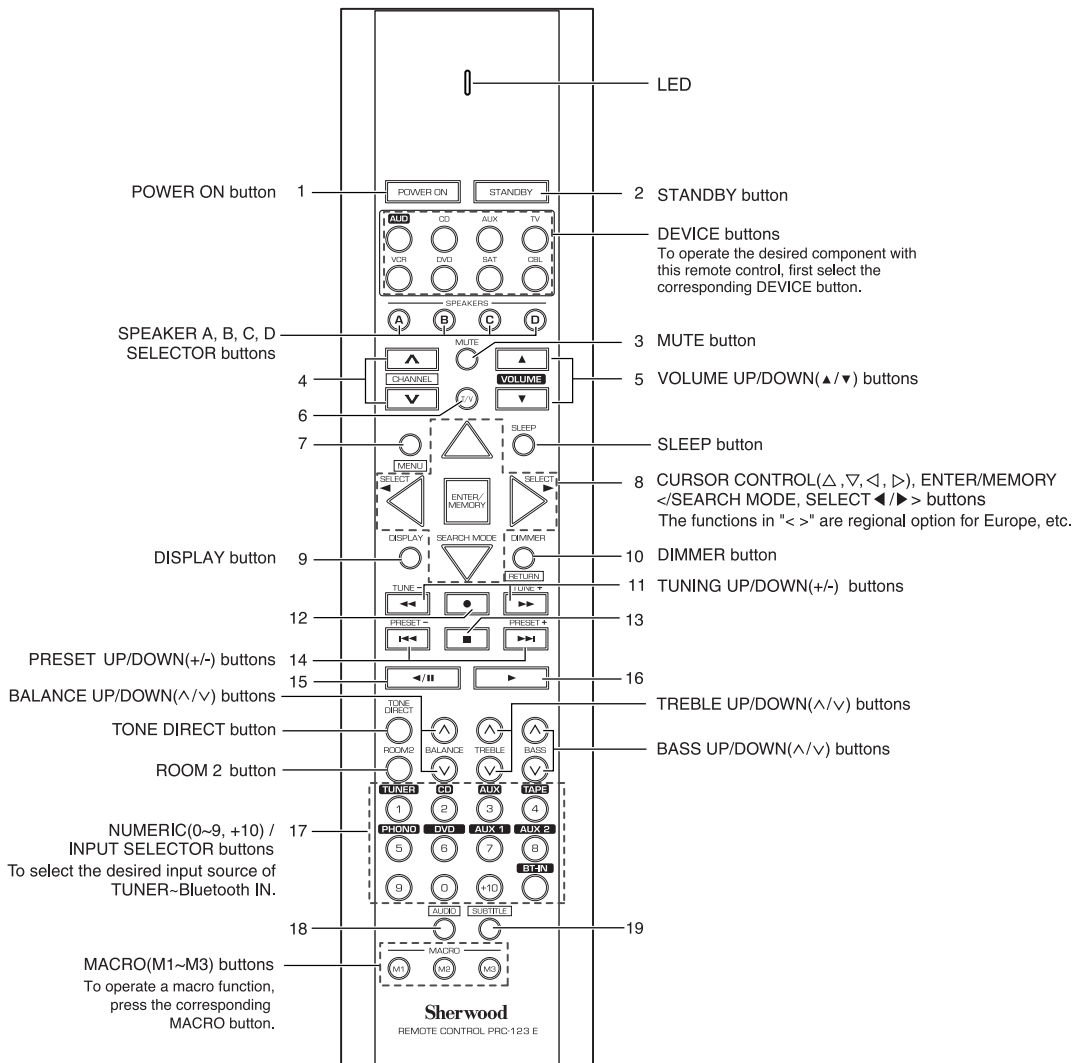















(For details, refer to "USING FUNCTIONS OF REMOTE CONTROL" on page 13.)

- The numbered buttons on the remote control have different functions in different device modes. For details, refer to "FUNCTION TABLE of the NUMBERED BUTTONS" on the next page.

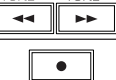
■ **Note** : In such a case that some components do not have the REMOTE SENSOR which receives the remote signals, this remote control cannot operate them.

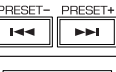
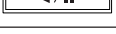

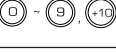
■ FUNCTION TABLE of the NUMBERED BUTTONS.

Device to be controlled Button symbol	CD  (for CD player)	AUX  (for tape deck)	TV  (for TV)	VCR  (for VCR)	DVD  (for DVD player)	SAT  (for satellite receiver)	CBL  (for cable box)
1 	POWER ON	POWER ON	POWER ON	POWER ON	POWER ON	POWER ON	POWER ON
2 	STANDBY (POWER OFF)	STANDBY (POWER OFF)	STANDBY (POWER OFF)	STANDBY (POWER OFF)	STANDBY (POWER OFF)	STANDBY (POWER OFF)	STANDBY (POWER OFF)
3 	—	—	MUTE	MUTE	—	MUTE	MUTE
4 	—	—	CHANNEL UP/DOWN(▲/▼)	CHANNEL UP/DOWN(▲/▼)	—	CHANNEL UP/DOWN(▲/▼)	CHANNEL UP/DOWN(▲/▼)
5 	—	—	VOLUME UP/DOWN(▲/▼)	VOLUME UP/DOWN(▲/▼)	—	VOLUME UP/DOWN(▲/▼)	VOLUME UP/DOWN(▲/▼)
6 	—	—	INPUT SELECTOR	INPUT SELECTOR	—	INPUT SELECTOR	INPUT SELECTOR
7 	—	—	—	—	MENU	—	—
8 	—	—	—	—	CURSOR CONTROL	—	—
					ENTER		
9 	—	—	—	—	DISPLAY	—	—
10 	—	—	—	—	RETURN	—	—
11 	REVERSE SEARCH(◀◀) / FORWARD SEARCH(▶▶)	REWIND(◀◀) / FAST FORWARD(▶▶)	—	REWIND(◀◀) / FAST FORWARD(▶▶)	REVERSE SEARCH(◀◀) / FORWARD SEARCH(▶▶)	—	—
12 	—	RECORD	—	RECORD	—	—	—
13 	STOP	STOP	—	STOP	STOP	—	—
14 	REVERSE SKIP(◀◀) / FORWARD SKIP(▶▶)	—	—	—	REVERSE SKIP(◀◀) / FORWARD SKIP(▶▶)	—	—
15 	PAUSE	REVERSE PLAY	—	PAUSE	PAUSE	—	—
16 	PLAY	FORWARD PLAY	—	PLAY	PLAY	—	—
17 	NUMERIC	—	NUMERIC	NUMERIC	NUMERIC	NUMERIC	NUMERIC
18 	—	—	—	—	AUDIO	—	—
19 	—	—	—	—	SUBTITLE	—	—

■ Notes :

- Some functions for each component may not be available or may work differently.
- Depending on other kinds of components that are available for each DEVICE button, some functions may not be available or may work differently, too.
- For details about functions, refer to the operating instructions of each component.

OPERATING COMPONENTS WITH REMOTE CONTROL

1. Enter the setup code for each component other than this receiver. For details, refer to "Entering a setup code" on page 13.

2. Turn on the component you want to operate.

3. Press the DEVICE button on the remote control corresponding to the component you wish to operate.

4. Aim the remote control at the REMOTE SENSOR of the component you wish to control and press the button corresponding to the operation you want.

REMOTE CONTROL OPERATION RANGE

- Use the remote control within a range of about 7 meters (23 feet) and angles of up to 30 degrees aiming at the remote sensor.

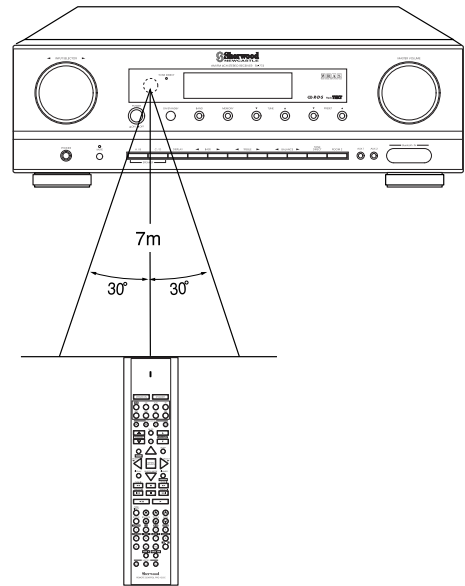

LOADING BATTERIES

- When the remote control does not operate, the old batteries should be replaced. In this case, load new batteries within several minutes after removing old batteries.
- If the batteries are removed or have been exhausted for a longer period of time, memorized contents will be cleared. Should this happen, you should memorize them again.

1. Remove the cover.

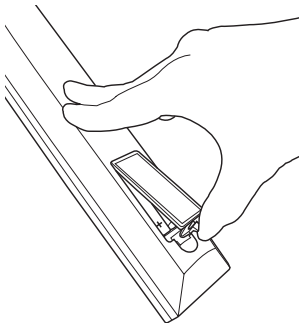

2. Load two batteries ("AAA" size, 1.5V) matching the polarity.

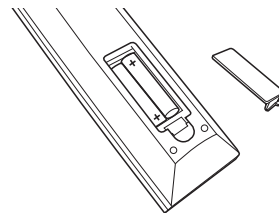

- Remove the batteries when they are not used for a long time.
- Do not use the rechargeable batteries (Ni-Cd type).
- Be sure to use alkaline batteries.

USING FUNCTIONS OF REMOTE CONTROL

- This remote control can control up to 8 different components.
- Before operating audio and video components other than this receiver with using this remote control, the setup code for each component should be entered.
- For system remote control operation, "000" was stored previously in the memory of the device button "CD" for Sherwood CD player, "DVD" for Sherwood DVD player, "AUX" for Sherwood tape deck and "TV" for Sherwood TV respectively as its factory setup code. So, you don't need to enter its code for each Sherwood component except in such a case that its code does not work.

Entering a setup code

1. Turn on the component you want to operate.
2. Find the setup codes according to the type and the brand name of your component, referring to "Setup Code Table" on page 28.
3. Press and hold down both the "ENTER/MEMORY" button and the desired one of the DEVICE buttons for more than 1 seconds.

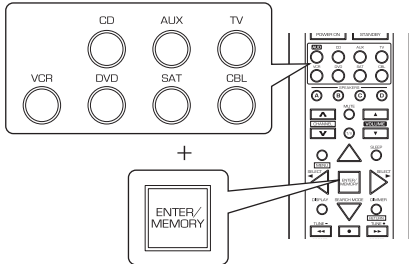

- The LED will flicker once.
- **Note** : The "AUD" button is unavailable for the audio components other than this receiver.

4. Enter a 3 digit code, aiming the remote control at the remote sensor on the component.

Example) When entering "001".

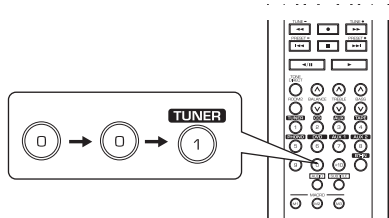

- If entering is performed successfully, the LED will flicker twice.
- To be sure that the setup code is correct, press the POWER ON(or STANDBY) button.
If your component is tuned off, the setup code is correct.
- When your component is not turned off, repeat the above steps 2 to 4, trying each code for your component until you find one that works.

- **Notes:**
- If the LED did not flicker twice, then repeat the above steps 3 to 4 and try entering the same code again.
 - Manufacturers may use different setup codes for the same product category. For that reason, it is important that you check to see if the code you have entered operates as many controls as possible. If only a few functions operate, check to see if another code will work with more buttons.

5. Repeat the above steps 1 to 4 for each of your components.

Using a punch-through function

This remote control may be programmed to operate either the AUDIO volume punch-through or the TV volume and/or TV channel punch-through in conjunction with any of the eight components controlled by this remote control. For example, since this receiver will likely be used as the sound system while watching TV, you may want to adjust this receiver's volume although this remote control is set to control the TV.

- When programming this remote control for the AUDIO volume punch-through, press and hold down both "AUD" button and "VOLUME ▲" button for more than 1 second.

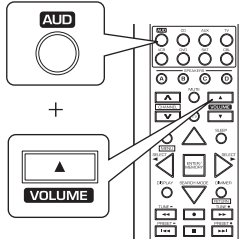

- If programming is performed successfully, the LED will flicker twice.
 - When you want either TV volume or TV channel punch-through, press and hold down both "TV" button and either "VOLUME ▲" or "CHANNEL ▲" button for more than 1 second.
- **Note:** If you use one of AUDIO and TV volume punch-through functions, you cannot use the other.

■ Removing a punch-through function

- When removing the AUDIO volume punch-through, press and hold down both "AUD" button and "VOLUME ▼" button for more than 1 second.

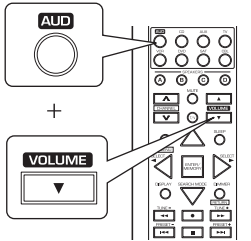

- If removing is performed successfully, the LED will flicker twice.
- When you want to remove either TV volume or TV channel punch-through, press and hold down both "TV" button and either "VOLUME ▼" or "CHANNEL ▼" button for more than 1 second.

Programming a macro function

- The macro function enables you to program a series of button operations (up to 10) on this remote control into a single button.
- You can store up to three separate macro command sequences into "M1", "M2" and "M3" buttons.

1. Press and hold down both "ENTER/MEMORY" button and one of three NUMERIC buttons ("1"~"3") corresponding to "M1"~"M3" buttons for more than 1 second.

Example) When programming a series of button operations into "M1" button.

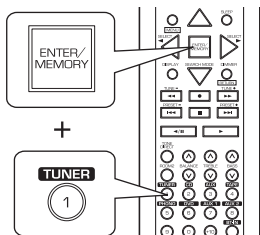

- If the macro mode is entered, the LED will flicker once.

3. Press "ENTER/MEMORY" button.

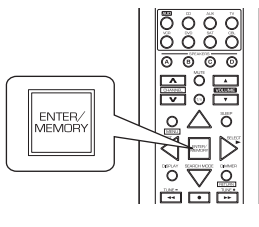

- If the programming is performed successfully, the LED will flicker twice.

■ To remove a macro program

- When removing a macro program, perform the above steps 1 and 3, but ignore the step 2.

■ To change a macro program

- When a new macro program is stored into a MACRO button with performing the above steps 1 to 3, the previous macro program is cleared from the memory of the MACRO button.

Operating a macro function

- Aim the remote control at the REMOTE SENSORS of the components to be controlled and press the MACRO button you want.

Example) When pressing "M1" button.

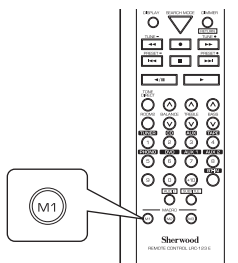

2. Press the operation buttons you want to program in order.

- **Note:** You should press the corresponding DEVICE buttons before pressing each operation button.

Example) When playing a CD on the CD player connected to CD jacks of this receiver.

- ①. Press "AUD" button to control this receiver.
- ②. Press "POWER ON" button to turn this receiver on.
- ③. Press "AUD" button to control this receiver.
- ④. Press "CD (2)" button to select the desired input source.
- ⑤. Press "CD" button to control the CD player.
- ⑥. Press "POWER ON" button to turn the CD player on.
- ⑦. Press "CD" button to control the CD player.
- ⑧. Press "▶" button to start playback.

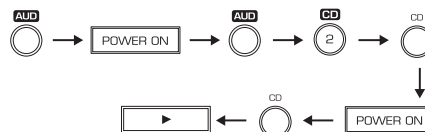

■ Notes:

- The codes programmed into a MACRO button will be transmitted at an interval of 0.5 seconds. However, some components may not be able to complete one operation in 0.5 seconds and may miss the next code. In this case, the macro function cannot control the corresponding components correctly.
- Be sure to use the remote control within the remote control operation range of the components.
- Depending on the operation status of the components, etc., the macro function cannot control the corresponding components correctly.

Operations

LISTENING TO A PROGRAM SOURCE

Before operation

- Push the POWER switch.

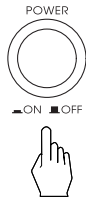

- This unit enters the standby mode and the POWER ON/STANDBY button lights up amber. This means that the receiver is not disconnected from the AC mains and a small amount of current is retained to support the operation readiness.
- To switch the power off, push the POWER switch again. Then the power is cut off and the POWER ON/STANDBY button goes off.

1. In the standby mode, turn the power on.

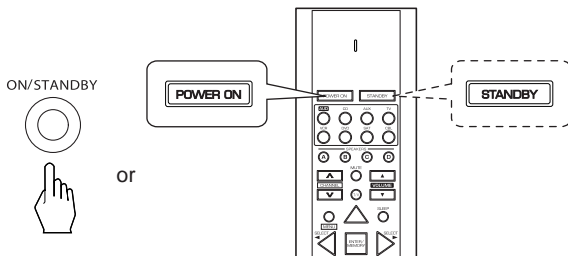

- Each time the POWER ON/STANDBY button on the front panel is pressed, the receiver is turned on to enter the operating mode (the POWER ON/STANDBY button lights up blue) or off to enter the standby mode (the POWER ON/STANDBY button lights up amber).
- On the remote control, press the POWER ON button to enter the operating mode or press the STANDBY button to enter the standby mode.

2. Switch the desired speakers on.

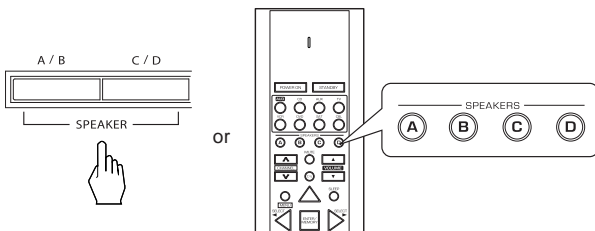

- You can select the various combinations of speakers depending on where the speakers C or/and D are installed.
- Each time the SPEAKER A/B SELECTOR button on the front panel is pressed, the speakers are switched on or off as follows:

→ A/B ~ → - / - ~ → A / - ~ → - / B ~
 or (MAIN A/B) or (MAIN - / -) or (MAIN A / -) or (MAIN - / B)

(): When the ROOM2 mode is set to on.

- Each time the SPEAKER C/D SELECTOR button on the front panel is pressed, the speakers are switched on or off as follows:

→ ~ C / D → ~ - / - → ~ C / - → ~ - / D
 or (R2 C/D) or (R2 - / -) or (R2 C / -) or (R2 - / D)

(): When the ROOM2 mode is set to on.

- When using the headphones for private listening, switch off all the speakers installed in the main room.

■ **Note:** To use ROOM2 function, you should install speakers C or/and D in another room (ROOM2) and set the ROOM2 mode to on. (For details, refer to "CONNECTING SPEAKERS" on page 6 and "ROOM2 PLAYBACK" on page 24.)

3. Select the desired input source.

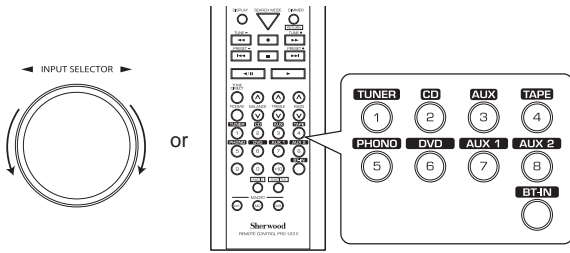

- Each time the INPUT SELECTOR knob is rotated, the input source is changed as follows:



4. Operate the selected component for playback.

5. Adjust the volume to a comfortable listening level.

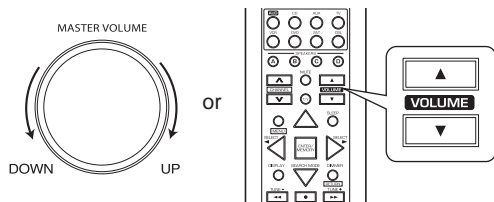

6. To mute the sound.

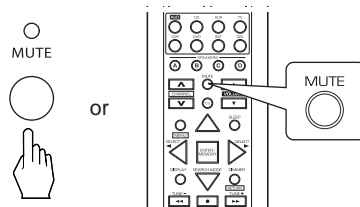

- "MUTE" flickers.
- To resume the previous sound level, press this button again.
- When adjusting the volume, the mutting effect is turned off.

7. To listen with the headphones.



- Be sure to switch off all the speakers installed in the main room.
- **Note** : Be careful not to set the volume too high when using headphones.

Adjusting the tone (bass and treble)

8. Adjust the tone as desired.

■ When adjusting the bass

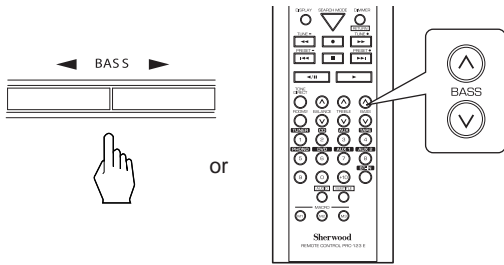

■ When adjusting the treble

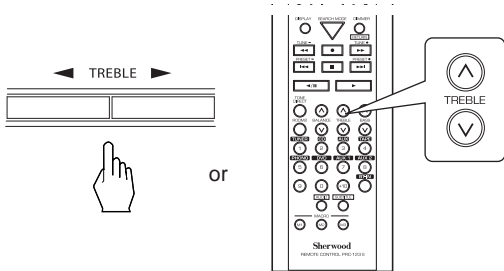

- Each time the buttons are pressed, the tone (BASS and TRBL) can be adjusted within the range of -10~+10 dB.

■ Notes :

- When the tone direct function is activated, the tone mode cannot be entered and "TON DIR" flickers for 3 seconds.
- Extreme settings at high volume may damage your speakers.
- In general, the bass and treble levels are adjusted to 0.

9. To listen to a program source without the tone effect.

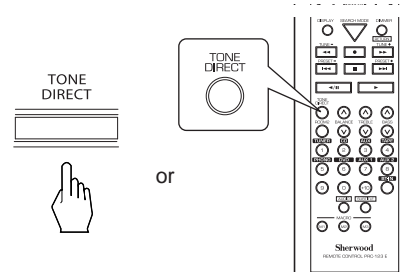

- "TON DIR" is displayed, "DIRECT" lights up and the sound that bypasses the tone circuitry will be heard.
- To cancel the tone direct function, press this button again to display "TON CTRL", and then "DIRECT" goes off.

Adjusting the sound volume balance

10. Adjust the sound volume balance between the left and right speakers.

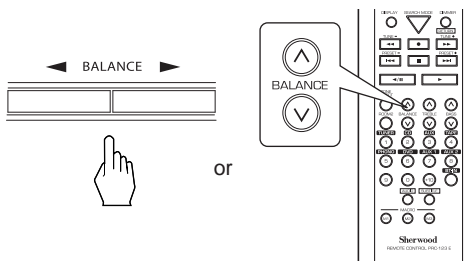

- Each time the buttons are pressed, the balance level can be adjusted within the range of L 10~R 10.

■ Note : In general, the balance level is adjusted to 0.

LISTENING TO RADIO BROADCASTS

Auto tuning

1. Select the tuner and then the desired band.

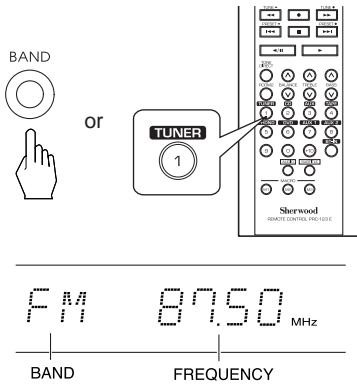

- Each time this button is pressed, the tuner is automatically selected and the band is changed as follows ;

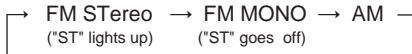

- When FM stereo broadcasts are poor because of weak broadcast signals, select the FM mono mode to reduce the noise, then FM broadcasts are reproduced in monaural sound.

Manual tuning

- Manual tuning is useful when you already know the frequency of the desired station.
- After selecting the desired band, press the TUNING UP(▲, +)/ DOWN(▼, -) buttons repeatedly until the right frequency has been reached.

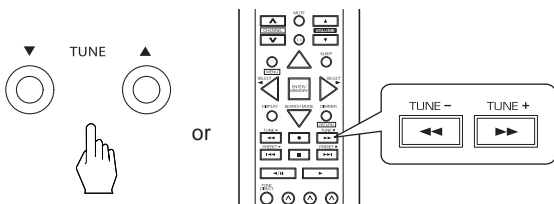

2. Press the TUNING UP(▲, +)/ DOWN(▼, -) buttons for more than 0.5 second.

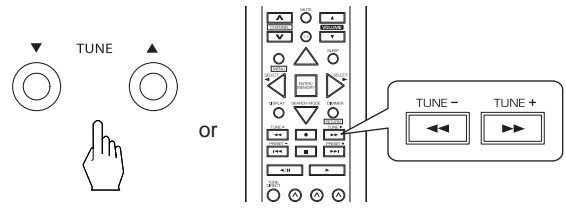

- The tuner will now search until a station of sufficient strength has been found. The display shows the tuned frequency and "TUNED".
- If the station found is not the desired one, simply repeat this operation.
- Weak stations are skipped during auto tuning.

Auto presetting

- Auto presetting function automatically searches for FM stations only and store them in the memory.
- While listening to radio broadcasts, press and hold down the (ENTER)/MEMORY button for more than 2 seconds.

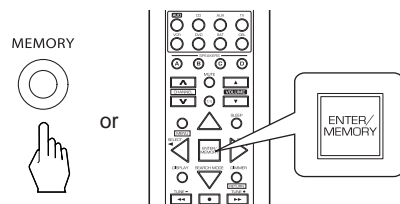

- Then "AUTO MEM" flickers and this receiver starts auto presetting.
- Up to 30 FM stations can be stored.

Notes:

- FM stations of weak strength cannot be memorized.
- To memorize AM stations or weak stations, perform "Manual presetting" procedure with using "Manual tuning" operation.

Manual presetting

- You can store up to 30 preferred stations in the memory.

1. Tune in the desired station with auto or manual tuning.

2. Press the (ENTER)/MEMORY button.

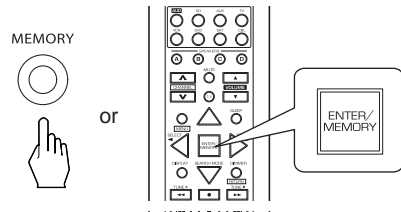

- "MEM" is flickering for 5 seconds.

3. Select the desired preset number (1~30) and press the (ENTER)/MEMORY button.

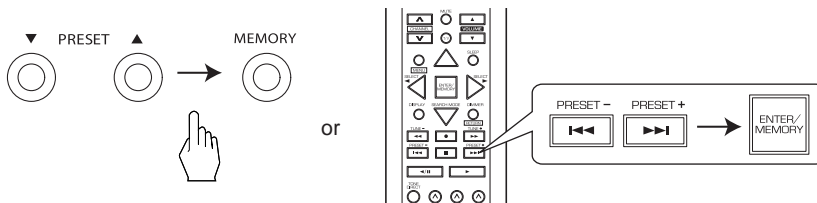

- The station has now been stored in the memory.
- A stored frequency is erased from the memory by storing another frequency in its place.
- If "MEM" goes off, start again from the above step 2.

4. Repeat the above steps 1 to 3 to memorize other stations.

■ MEMORY BACKUP FUNCTION

The following items, set before the receiver is turned off, are memorized.

- INPUT SELECTOR settings
- Preset stations, etc.
- The ROOM2 settings

Tuning to preset stations

- After selecting the tuner as an input source, select the desired preset number.

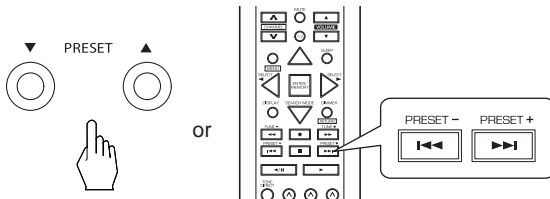

RDS Tuner(Regional Option for some countries in Europe, etc.) _____

LISTENING TO RDS BROADCASTS (FM ONLY)

RDS(Radio Data System) is a method for sending information signals together with the transmitter signals. Your tuner is capable of translating these signals and putting the information on the display. These codes contain the following informations. Program Service name(PS), A list of Program Types(PTY), Traffic Announcement(TA), Clock Time(CT), Radio Text(RT).

■ **Note** : In the other countries, RDS tuner function cannot be available.

RDS search

• Use this function to automatically search and receive the stations offering RDS services.

1. In the FM mode, select the RDS search mode.

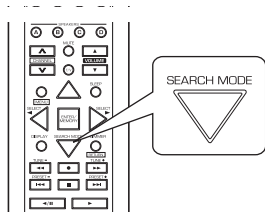

• Each time this button is pressed, the search mode changes as follows :
RDS SRCH → TP SRCH → PTY SRCH → OFF

2. While displaying "RDS SRCH".

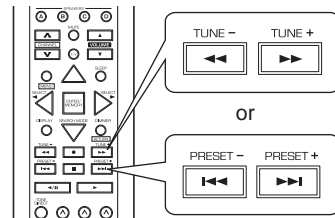

- The tuner automatically searches stations offering RDS services and the station name is displayed.
- If no other RDS station is found, "NO RDS" is displayed.
- When "RDS SRCH" is not displayed, repeat again from the above step 1.

TP search

• Use this function to automatically search and receive the stations broadcasting the traffic program.

1. In the FM mode, select the TP search mode.

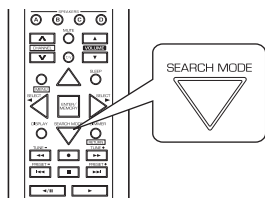

• "TP SRCH" is displayed.

2. While displaying "TP SRCH".

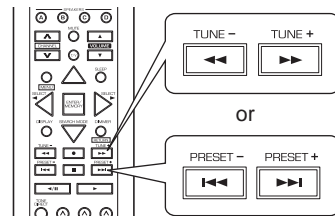

- The tuner automatically searches stations broadcasting the traffic program.
- "NO TRAFF" is displayed if the signal is too weak or there are no stations broadcasting the traffic program.
- When "TP SRCH" is not displayed, repeat again from the above step 1.

PTY search

- Use this function to automatically search and receive the stations broadcasting the desired program type.

1. In the FM mode, select the PTY search mode..

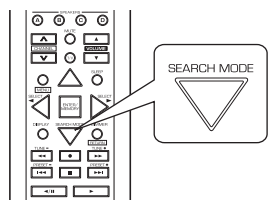

- "PTY SRCH" is displayed.

2. While displaying "PTY SRCH", select the desired program type.

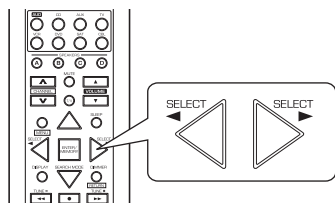

- Each time these buttons are pressed, one of 29 different types of programs is selected.
(NEWS, AFFAIRS, INFO, SPORT, EDUCATE, DRAMA, CULTURE, SCIENCE, VARIED, POP M, ROCK M, EASY M, LIGHT M, CLASSICS, OTHER M, WEATHER, FINANCE, CHILDREN, SOCIAL, RELIGION, PHONE IN, TRAVEL, LEISURE, JAZZ, COUNTRY, NATION M, OLDIES, FOLK M, DOCUMENT)

- When "PTY SRCH" is not displayed, repeat again from the above step 1.

3. While displaying the desired program type.

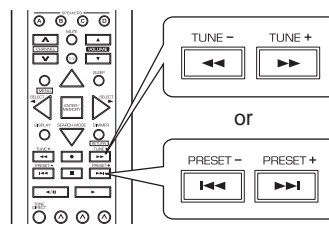

- The tuner automatically searches a station offering PTY services.
- If no station is found, "NO PROG" is displayed.

DISPLAY

- In the FM mode,

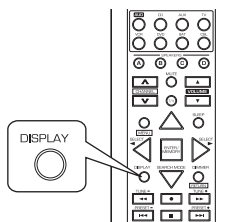

- Each time the DISPLAY button is pressed, the display mode changes as follows:

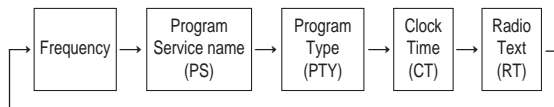

- If the signals are too weak or no RDS service is available, "NO NAME", "NO PTY", "NO TIME" or "NO TEXT" will be displayed.

RECORDING

- The volume, tone(bass, treble) and balance settings have no effect on the recording signals.
- When you select tuner, BT-IN, CD, DVD, AUX, AUX 1, AUX 2 or PHONO as a recording source, recording can be made on the TAPE.
- The ROOM2 input source cannot be recorded onto the TAPE.

Recording with TAPE

1. Select the desired input as a recording source except for TAPE.

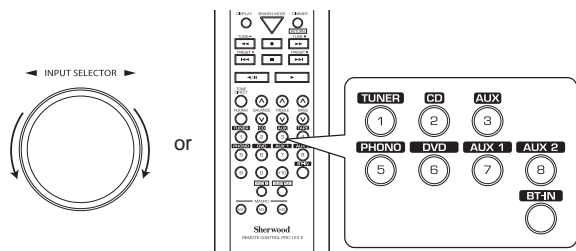

2. Start recording on the TAPE.

3. Start play on the desired input.

OTHER FUNCTIONS

Operating the sleep timer

- The sleep timer allows the system to continue to operate for a specified period of time before automatically shutting off.

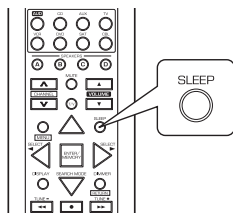

- Each time this button is pressed, the sleep time changes as follows:

→ 10 → 20 → 30 → ••• → 90 → OFF
Unit : minutes

- While operating the sleep timer, "  " lights up.
- When the sleep time is selected, the fluorescent display is dimly lit.
- When the ROOM2 function is operating, it will not be turned off by the sleep timer.

Adjusting the brightness of the fluorescent display

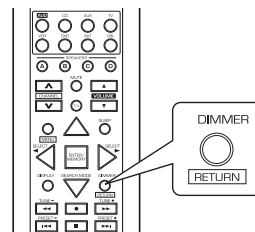

- Each time this button is pressed, the brightness of the fluorescent display changes as follows:

→ ON → dimmer → OFF

- In the display OFF mode, pressing any button will restore the display ON mode.

ROOM2 PLAYBACK

- This function allows enjoying one source in the main room and playing another in a different room at the same time.
- Even when this receiver enters the standby mode, in such a case that "R2" is dimly lit, meaning only the ROOM2 circuitry operates, the ROOM2 source can be played independently. Therefore, when you do not use the ROOM2 function, turn off the ROOM2 function to save electricity.
- To enjoy ROOM2 source, turn on the ROOM2 function and adjust the ROOM2 settings as below.

1. Enter the ROOM2 mode.

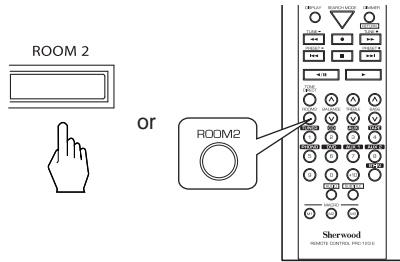

- "R2 > ~" is displayed for several seconds.
- Each time this button is pressed, the mode is changed to the ROOM2 mode ("R2 > ~") or the main mode (main input display).
- When "R2 > ~" is not displayed, press this button again.
- **Note** : Only while displaying the ROOM2 mode, you can set the ROOM2 mode.

2. Turn on the ROOM2 mode.

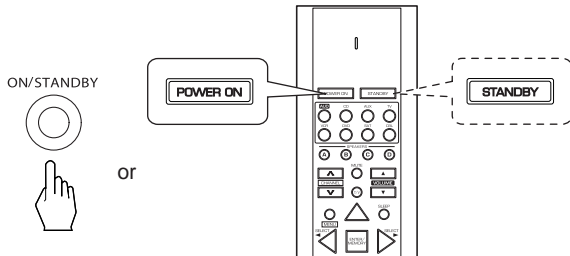

- Each time the POWER ON/STANDBY button on the front panel is pressed, the ROOM2 mode changes as follows :
 R2 > OFF : ROOM2 off mode("R2" turns off)
 ↓
 R2 > input display : ROOM2 on mode("R2" lights up)
- On the remote control, press the POWER ON button to turn on the ROOM2 mode or press the STANDBY button to turn it off.
- **Note** : Only while displaying the ROOM2 on mode, you can adjust the ROOM2 settings.

3. Select the desired ROOM2 speakers.

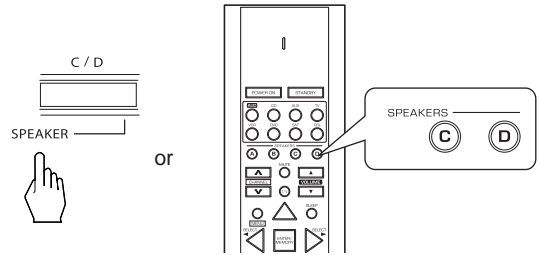

- Each time the SPEAKER C/D SELECTOR button is pressed, the speakers are switched on or off as follows:

→ R2 C/D → R2 - / - → R2 C/ - → R2 - /D →

- **Note** : Only when the ROOM2 mode is set to on, the speakers C or/and D can be used as ROOM2 speakers.

4. Select the desired ROOM2 input.

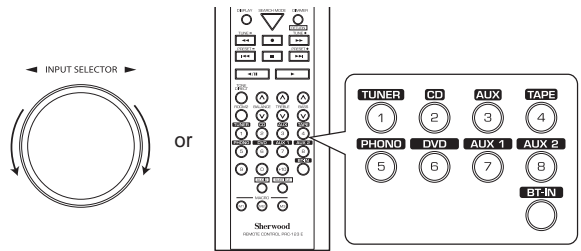

- Each time the INPUT SELECTOR knob is rotated, the ROOM2 input source is changed as follows :

↳ TUNER ↔ PHONO ↔ AUX 2 ↔ AUX 1 ↳
 ↳ BT-IN ↔ CD ↔ TAPE ↔ DVD ↔ AUX ↳

5. Start play on the component related to the ROOM2 source.

6. Adjust the ROOM2 volume to a comfortable listening level.

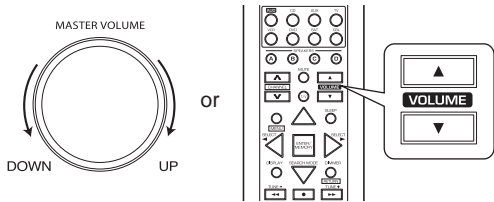

7. To mute the sound.

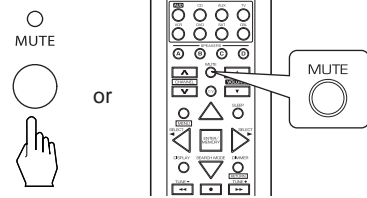

- While the mute function for ROOM2 is operating, "R2" is flickering.
- To resume the previous sound level, press this button again.

Troubleshooting Guide

If a fault occurs, run through the table below before taking your receiver for repair.

If the fault persists, attempt to solve it by switching the receiver off and on again. If this fails to resolve the situation, consult with your dealer. Under no circumstances should you repair the receiver yourself as this could invalidate the warranty.

PROBLEM	POSSIBLE CAUSE	REMEDY
No power	<ul style="list-style-type: none"> • The AC input cord is disconnected. • Poor connection at AC wall outlet or the outlet is inactive. 	<ul style="list-style-type: none"> • Connect the cord securely. • Check the outlet using a lamp or another appliance.
No sound	<ul style="list-style-type: none"> • The speaker cords are disconnected. • The volume is adjusted too low. • The MUTE button on the remote control is pressed to ON. • Speakers are not switched on. • Incorrect selection of the input source. • Incorrect connections between the components. 	<ul style="list-style-type: none"> • Check the speaker connections. • Adjust the volume. • Press the MUTE button to cancel the muting effect. • Switch on the desired speakers. • Select the desired input source correctly. • Make connections correctly.
Stations cannot be received	<ul style="list-style-type: none"> • No antenna is connected. • The desired station frequency is not tuned in. • The antenna is in wrong position. 	<ul style="list-style-type: none"> • Connect an antenna. • Tune in the desired station frequency. • Move the antenna and retry tuning.
Preset stations cannot be received	<ul style="list-style-type: none"> • An incorrect station frequency has been memorized. • The memorized stations are cleared. 	<ul style="list-style-type: none"> • Memorize the correct station frequency. • Memorize the stations again.
Poor FM reception	<ul style="list-style-type: none"> • No antenna is connected. • The antenna is not positioned for the best reception. 	<ul style="list-style-type: none"> • Connect an antenna. • Change the position of the antenna.
Continuous hissing noise during FM reception, especially when a stereo broadcast is received.	<ul style="list-style-type: none"> • Weak signals. 	<ul style="list-style-type: none"> • Change the position of the antenna. • Install an outdoor antenna.
Continuous or intermittent hissing noise during AM reception, especially at night.	<ul style="list-style-type: none"> • Noise is caused by motors, fluorescent lamps or lightning, etc. 	<ul style="list-style-type: none"> • Keep the receiver away from noise sources. • Install an outdoor AM antenna.
No recording	<ul style="list-style-type: none"> • Incorrect selection between the components. • Incorrect operation of each component for playback and recording. 	<ul style="list-style-type: none"> • Make connections correctly. • Operate each component correctly.
Remote control unit does not operate.	<ul style="list-style-type: none"> • Batteries are not loaded or exhausted. • The remote sensor is obstructed. 	<ul style="list-style-type: none"> • Replace the batteries. • Remove the obstacle.

Specifications

■ AMPLIFIER SECTION

- Power output, 8Ω, THD 0.7 %, 20 Hz~20 kHz, only a pair of speakers driven | **2 X 100 W**
- Total harmonic distortion, 8Ω, @ -3dB, 20 Hz~20 kHz | **0.05 %**
- Intermodulation distortion
60 Hz : 7 kHz= 4 : 1 SMPTE, 8Ω, 100 W | **0.03 %**
- Input sensitivity, 47 kΩ
Phono(MM) | **2.5 mV**
Line(CD,DVD,TAPE,AUX) | **220 mV**
- Signal to noise ratio, IHF "A" weighted
Phono(MM) | **75 dB**
Line(CD,DVD,TAPE,AUX) | **98 dB**
- Frequency response
Phono(MM), RIAA, 20 Hz~20 kHz | **±0.3 dB**
Line(CD,DVD,TAPE,AUX), 10 Hz~100 kHz | **±3 dB**
- Output level
TAPE OUT, 2.2 kΩ | **200 mV**
- Bass/Treble control, 100 Hz/10 kHz | **±10 dB**

■ FM TUNER SECTION

- Tuning frequency range | **87.5~108 MHz**
- Usable sensitivity, THD 3%, S/N 26 dB | **15 dBf**
- 46 dB quieting sensitivity, mono/stereo | **25.2/45.2 dBf**
- Signal to noise ratio, 65 dBf, mono/stereo | **68/65 dB**
- Total harmonic distortion, 65 dBf, 1 kHz, mono/stereo | **0.5/0.8%**
- Frequency response, 20 Hz~14 kHz | **±3 dB**
- Stereo separation, 1 kHz | **30 dB**
- Capture ratio | **4 dB**
- IF rejection ratio | **75 dB**

■ AM TUNER SECTION

- Tuning frequency range | **522~1611 kHz**
- Usable sensitivity, S/N 20 dB | **55 dBμ/m**
- Signal to noise ratio | **50 dB**
- Selectivity | **30 dB**

■ GENERAL

- Power supply | **230 V~ 50 Hz**
- Power consumption | **330 W**
- Switched AC outlet | **TOTAL 100 W (0.43 A)**
- Dimensions (W × H × D, including protruding parts) | **440X141X370mm(17-3/8X5-1/2X14-1/2 inches)**
- Weight (Net) | **8.6 kg(19 lbs)**

Note: Design and specifications are subject to change without notice for improvements.

Setup Code Table

TV

ENGLISH

ADMIRAL	050	134				
AKAI	093	049	123			
ALBA	068					
ALBIRAL	116					
ALCATEL	022					
AMSTRAD	000	021				
ANAM	155	156	157			
ARC EN CIEL	028	039	043	145	081	
ARISTONA	099	049	050	019	142	149
	078					
ARTHUR MARTIN	053	139	117	120	122	123
	125	128				
ASA	050	055	057	113	134	
ATLANTIC	099	111				
AUDIOSONIC	054					
AUSIND	053					
AUTOVOX	099	144	055	019	057	069
BAIRD	083					
BASICLINE	006					
BAUR	011					
BEKO	023	049				
BLAUPUNKT	094	100	102	111	114	
BRANDT	028	039	040	043	145	081
BRION VEGA	050					
BRUNS	048	050				
BSR	059	110	132			
BUSH	033	068	124	074		
CENTURY	098	101	050	079	136	
CGE	016	101	124	079	132	136
CIHAN	065					
CLARIVOX	048	116				
CONDOR	099	111				
CONTEC	087					
CONTINENTAL						
EDITION	028	039	040	043	145	081
CROSLEY	101	050	109			
CROWN	147					
CTC CLATRONIC	046					
DAEWOO	089					
DECCA	099	060	063	115	118	
DEGRAAF	036					
DIXI	049	090				
DRYNATRON	049					
DUAL	099	141				
DUAL-TEC	096	099	132			
DUMONT	046	050	057	073		
ELBE	016	116				
ELBIT	065					
ELCIT	046	097	103	050	109	127
	132					
ELMAN	046	132				
ELTA	090					
EMERSON	158	098	050			
ERRES	049	142				
EUROPHON	098	046	097	099	051	115
	132					
FERGUSON	146	040	041	150	057	061
	116	149				
FIDELITY	099	149				
FINLUX	034	046	053	055	057	109
	113	073	074	079		
FISHER	015	048	050	052	109	136
FORGESTONE	149					
FORMENTI	099	053	109	111	125	
FORTRESS	137					
FRABA	075					
FRONTECH	054					
FUJITSU	025					
FUNAI	054	059				
GBC	109	132				
GEC	099	060	109	115	134	088
GELOSO	103	109	132	134	090	
GOLDSTAR	092	003	017	099	049	075
	076	077	090	152		
GOODMANS	033	049	060	077		
GORENJE	066	136				
GREATZ	001	058	109	122	123	128
	129	130	134			
GRANADA	033	099	049	058	060	142
	115	125	134			
GRUNDIG	094	100	057	058	108	112
	114	082				
HANSEATIC	033	047	099	049	109	139
	111					
HANTAREX	097					
HEMMERMANN	127					
HIFIVOX	028	039	043	145	081	
HINARI	158	033	045	143	090	
HITACHI	014	033	034	036	099	145
	056	109	139	110	067	117
	132	134	084	091	081	088
HYPER	093	099				
IMPERIAL	016	101	124	079	132	133
INGELEN	001	058	109	122	128	129
	130	134				

INNO HIT	093	098	097	099	143	077
	090					
INTERFUNK	047	049	050	145	058	109
	142	123	128	129	091	
IRRADIO	093	143	053	077	090	
ITT	001	140	058	105	109	122
	123	128	148	129	130	134
	135	083	089			
JVC	033	154				
KTV	099					
KAISUI	006					
KARCHER	006					
KENDO	098					
KENNEDY	144	019	109			
KORTING	050	059	111			
KRIESLER	099	049	050	019	142	149
	078					
LENOIR	099					
LOEWE OPTA	008	097	047	049	050	115
	072					
LOGIK	118	149				
LUMA	049	120	134			
LUXOR	058	139	117	120	123	129
	135	083				
MAGNADYNE	046	097	103	050	109	115
	127	132				
MAGNAFON	046	097	099	051	053	115
MARANTZ	049					
MATSUI	158	099	106	060	118	068
	134	090				
McMICHAEL	088					
MEMOREX	090					
METZ	094	050	114	133		
MINERVA	094	100	057	058	114	
MISTRAL	149					
MITSUBISHI	033	035	047	049	050	062
	118	119	148	080	138	
MIVAR	097	099	115	077		
MULTITECH	046	099	115	136		
MURPHY	134					
MAONIS	096	144	019	110	134	
NATIONAL	042	104	109			
NEC	033	085				
NECKERMANN	099	050	139	120	136	
NEI	049					
NIKKAI	060					
NOBLEX	015					
NOBLIKO	098	046	099	053	057	
NOGAMATIC	028	039	043	145	081	
NOKIA	001	140	058	105	109	122
	123	128	148	129	130	134
	135	083	089			

NORDMENDE	028	032	039	043	145	131
	091	081				
OCEANIC	109	064	123			
ONCEAS	099					
OPTONICA	137					
ORION	000	059	118	068	127	090
OSAKI	060					
OSIO	077					
OSUME	087					
OTTO VERSAND	033	047	049	109	139	
P.T ACTTRON	065					
PAEL	099	053				
PANASONIC	030	042	095	104	107	109
	121	126				
PATHE CINEMA	099	111	116	132		
PERDIO	060					
PHILCO	016	030	101	050	109	124
	079	132	136			
PHILIPS	009	010	013	018	024	099
	049	050	019	142	148	149
	078	088				
PHOENIX	099	053	109	111	125	
PHONOLA	099	049	050	019	142	149
	078					
PIONEER	020	049	145	091		
PRANDONI-						
PRINCE	098	097	053	115	134	
PREMIER	124					
PRINCE	098	097	053	134		
PROTECH	049	054				
PYE	099	049	050	019	142	148
	149	078				
QUASAR	046	097	051	053	077	
QUELLE	047	099	100	049	053	055
	057	058	111	112	113	114
	118	123	073	074	128	
RADIOLA	099	049	050	019	142	149
	078					
RADIOMARELLI	046	097	103	050	109	062
	127	132				
RANK	074					
RBM	074					
REDIFFUSION	062	123	134			
REX	096	144	019	141	110	069
	134					
ROBOTRON	048	050				
RTF	048	050				
SABA	028	031	032	037	039	040
	043	097	050	145	115	120
	086	091	081			
SAISHO	158	099	118	119	068	090
SALORA	053	139	117	120	122	123
	125	128	135	083		

SAMBERS	046	097	051	053	115	077
SAMPO	121					
SAMSUNG	015	026	099	054	077	136
	090	151	153			
SANYO	001	002	005	033	044	048
	060	113	118	071	054	136
SBR	049	142	148	149	088	
SCHAUB LORENZ	001	058	109	122	123	128
	129	130	134			
SCHNEIDER	096	099	049	050	052	019
	141	109	142	125	149	078
	132					
SEG	046					
SEI	158	059				
SELECO	016	096	144	019	141	110
	069	134				
SHARP	033	087	137			
Sherwood	000					
SIAREM	046	097	050	109	115	
SICATEL	116					
SIEMENS	005	094	036	100	111	114
	087					
SIERA	099	049	050	019	142	149
	078					
SILVER	054					
SINGER	016	046	050	109		
SINUDYNE	158	046	050	059	109	127
SONOKO	049	090				
SONY	146	007	027	033	038	118
STERN	096	144	019	110	069	134
TANDBERG	133					
TANDY	099	060	137			
TASHIKO	002	033				
TATUNG	099	060	063	065	115	118
TEC	096	099	132			
TELEAVIA	028	039	040	043	145	091
	081					
TELEFUNKEN	028	041	145	150	086	091
TELETECH	090					
TELEVIDEON	099	053	109	111	125	
TENSAI	049					
THOMSON	012	028	032	039	040	043
	145	091	081			
THORN- FERGUSON	014	040	041	054	150	057
	061	116	149	086		
TOCOM	029					
TOSHIBA	004	016	033	070	074	
TRANS						
CONTINENTS	098	097	053	134		
TRIUMPH	158					
UHER	052	111	125			
ULTRA VOX	098	046	099	050	109	120

UNIVERSUM	092	034	054	077		
UNIVOX	116					
VEGAVOX	079					
VOXSON	050	134				
WATSON	111					
WATT RADIO	046	099	051	109	116	127
WEGA	033					
WHITE						
WESTINGHOUSE	099	111				
YOKO	099					
ZANUSSI	096	144	019	110	069	134
ZOPPAS	096	144	019	110	134	

VCR

AKAI	042	022	052	032	033	
ALBA	008	020				
AMSTRAD	011					
ANITSCH	009					
ARC EN CIEL	042	056	052			
ARISTONA	045	031				
ASA	018					
AWIA	011	042				
BAIRD	042	033				
BAUER. BOSCH	014	043				
BLAUPUNKT	014	043	055	031	054	040
BRANDT						
ELECTRONIQUE	042	056	052			
BRIONVEGA	041					
BUSH	008	020				
C.EDISON	041					
CANON	014					
CAPEHART	020					
CGE	011	042	052			
CONTINENTAL						
EDISON	042	056	052			
CRAIG	000	013				
CURTIS MATHES	019					
DAEWOO	001	020	021			
DAYTRON	020					
DECCA	011	042				
DEGRAAF	003	006	011	045	018	
DUAL	042	052				
DUMONT	003	011	018			
DYNATECH	011					
EMERSON	002	010	011	019	025	
FERGUSON	042	059	030	052	034	036
FIDELITY	011					
FINLANDIA	003	018				
FINLUX	003	006	011	018		
FISHER	000	003	005			

FUNAI	011
GE	019
GENERAL	014
GOLDSTAR	004 062
GOODMANS	008 011 046
GRAETZ	041 042 056 050 052 038
GRANADA	003 005 018
GRUNDIG	014 043 018 055 031 053
	054
HANSEATIC	043
HARMAN- KARDON	004
HIFIVOX	042 056 052
HINARI	002 008 024 027
HITACHI	006 007 011 042 057
IMPERIAL	011
INGELEN	042 056 052 038
INGERSOL	027
ITT	005 041 042 056 050 052
	033 038
JENSEN	042
JVC	042 056 060 030 052 063
KENWOOD	005 042 060
KRIESLER	045 031
KUBA	043
LLOYD	011
LOEWE OPTA	014 018 029 031
LOGIK	008 027
LUXOR	033 038
MAGNADYNE	041
MAGNASONIC	038
MAGNAVOX	019
MARANTZ	004 014 046 018 031
MATUI	010 025 027
MEMOREX	000 003 005 011 045
METZ	014 043 031 054 037
MGA	017
MINERVA	055 054
MINOLTA	006 007
MITSUBISHI	060 017 049
MTC	011 013
MULTITECH	008 011
MURPHY	011
NAONIS	042 056 052
NATIONAL	040
NEC	004 042 060 052
NECKERMANN	002 041 014 042 052
NOGAMATIC	042 056 052
NOKIA	003 005 041 042 056 050
	052 033 038
NORDMENDE	039 042 056 052 053 035
OPTONICA	045 046
ORION	002 010 025 027

OSAKI	011
OTTO VERAND	043
P. CINEMA	014
PALLADIUM	041 014
PANASONIC	023 051 040
PATHE MARCONI	042 056 052
PENTAX	006 007
PERDIO	011
PHILIPS	012 014 045 046 018 029
	031
PHONOLA	014 045 018 029 031
PIONEER	060
PORTLAND	020
PROLINE	011
PYE	014 045 018 029 031
QUARTZ	005
QUELLE	002 044 054
RADIOLA	045 031
RADIOMARELLI	041
RCA	019
REALISTIC	000 003 005 011 013 045
	046
REX	042 056 052
SABA	039 042 056 052 035
SAISHO	002 010 025 027
SALORA	005 017
SAMSUNG	013 019 032 061
SANSUI	042 060
SANYO	000 003 005 025 038
SBR	018 029
SCHAUB LORENZ	041 042 056 050 052 038
SCHNEIDER	008 011 045 031
SEI-SINUDYNE	027
SELECO	042 056 052
SENTRA	020
SHARP	045 046 105 048
SHINTOM	008
SIEMENS	014 043 055 031 054 038
SIERA	045 031
SINUDYNE	027
SONY	044 015 016 026 028
STERN	042 056 052
STS	006
SUNKAI	025
SYLVANIA	011 017
SYMPHONIC	011 017
TASHIKO	011
TATUNG	011 042
TEAC	011 042
TEKNIKA	011
TELEAVIA	042 056 052
TELEFUNKEN	042 056 052
TENOSAL	008

THOMSON	042	056	052			
THORN- FERGUSON	039	042	059	030	052	034
	036					
TOSHIBA	001	042	056	017	058	052
TOTELEVISION	013					
UHER	042					
ULTRA VOX	041					
UNITECH	013					
UNIVERSUM	041	014	043			
URANYA	041					
VECTOR	004					
VICTOR	042	060				
VIDITAL	041					
WESTING HOUSE	041					
WARDS	019					
YAMAHA	004	042				
ZANUSSI	042	056	052			
ZENDER	052					
ZOPPAS	042	056				

DVD

DENON	017					
GE	003	004				
JVC	007					
LG	011	010				
MAGNAVOX	019					
MITSUBISHI	001					
ONKYO	009					
PANASONIC	015					
PHILIPS	019					
PIONEER	002	023				
PROSCAN	003	004				
RCA	003	004				
SAMSUNG	016	008				
SHERWOOD	000	010	011	012	013	014
	022	020	021			
SONY	005					
THOMSON	003	004				
TOSHIBA	006					
VIETA	014					
YAMAHA	019					
ZENITH	011	010				

CBL

ABC	002	003	009	030		
	007	006	008			
Allegro	018	021				
Archer	018	026				
Bell&Howell	009					
Century	018					
Citizen	018	021				
Comtronics	014					
Contec	011					
Easten	001					
Emerson	026					
Everquest	010	014				
Focus	022					
Garrard	018					
Gemini	010					
General Instrument	033	276	006	034		
GoldStar	017	040				
Goodmind	026					
Hamlin	012	020	004	013		
Hitachi	006					
Hytex	007					
Jasco	010	018	021			
Jerrold	002	007	033	032	009	010
	006	034				
Memorex	000					
Movie Time	015					
NSC	015					
Oak	011					
Optimus	031					
Panasonic	000	016	031			
Paragon	000					
Philips	018					
Pioneer	017	025				
Popular Mechanics	022					
Pulsar	000					
Quasar	000					
RCA	031					
Radio Shack	010	021	026	028		
Recoton	022					
Regal	012	020				
Regency	001					
Rembrandt	006					
Runco	000					
SL Marx	014					
Smasung	017	014				
Scientific Atlanta	003	023	030	027		
Signal	010	014				
Signature	006					
Sprucer	031					
Starcom	002	010				

Stargate	010	014	026
Starquest	010		
TV86	015		
Teleview	014		
Tocom	007	008	
Toshiba	000		
Tusa	010		
Unika	018		
United Artists	007		
Universal	153	019	
Viewstar	015		
Zenith	000	024	
Zentek	022		

SAT

ALBA	030			
AMSTRAD	008	019	027	
ARCON	021			
ARISTONA	016			
ASTRA	028			
BLAUPUNKT	033			
BUSH	016			
CH.MASTER	030			
CITY COM	005			
DDC	030			
DYNASAT	005			
EHOSTAR	002	009	032	020
EMME ESSE	005			
FAIT	005			
FERGUSON	014	041	016	017 018
FINLUX	006	007	013	
FRACARRO	005			
FTE	022			
GOLDSTAR	004	021		
GRAETZ	026	037		
GROTHUSEN	004			
GRUNDIG	033	016	018	036
HINARI	030			
HIRSCHMANN	003	006		
HITACHI	013			
INGELEN	026	037		
ITT	034			
ITT-NOKIA	032	018	026	037
JERROLD	038	014		
KATHREIN	005	022	023	
KOSMOS	004			
KRIESLER	016			
LENCO	004	021		
LUXOR	026	037		

MAGAI	022				
MARANTZ	012				
MASPRO	016				
MATSUSHITA	000				
METZ	036				
MINERVA	036				
MULTISTAR	022				
MURATO	004				
NEC	040				
NEIRU	021				
NOKIA	026	037			
NORSAT	015				
PACE	001	042	016	017	018 044
PANASONIC	032				
PHILIPS	003	011	012	029	
PHONOLA	016				
PROSAT	030				
PYE	016				
QUADRAL	030				
QUELLE	036				
RADIOLA	016				
REDIFFUSION	015				
SABA	035				
SALORA	026				
SAMSUNG	003	022			
SAT PARTNER	004				
SATPORTNER	021				
SCHAUB LORENZ	026	037			
SCHNEIDER	005	016			
SIEMENS	033	036			
SIERA	016				
SILVA	004	021			
SKY	039				
STARCOM	038				
STARSAT	022				
TECHNISAT	003				
TELEFUNKEN	025				
TELESYSTEM	005				
THORN- FERGUSON	010	014	041	016	017 018
	043				
TRIAD	004				
UNIDEN	022				
UNITED CABLE	038				
V TECHNOLOGY	004				
VORTEC	003	024	025		
ZENDER	022				

CD

ADCOM	021					
AIWA	045	039	022			
AKAI	046					
AUDIO	016					
ARC EN CIEL	036	014	027	030	031	018
	230					
DENON	054					
FISHER	006					
H/K	017	012	047	016		
JVC	028	034	001			
KENWOOD	003	020	010	029	006	
MARANTZ	015	014				
MONDIAL	033					
AND	048	002	042			
NAKAMICHI	049					
NIKKO	016					
ONKYI	013	037	011	021	038	
PANASONIC	051	052				
PHILIPS	014					
PIONEER	005	008	041			
RCA	007	009				
REALISTIC	045					
SANSUI	040					
SHARP	019	053				
SHERWOOD	000	035	023	019	056	057
	058					
SONY	050	024	025	026		
TEAC	055	032				
TECHNICS	051	004	052			
VICTOR	001					
YAMAHA	044	043	016			

AUX-TAPE/MD

SHERWOOD	000(for tape deck)
	015 016(for MD recorder)

AUX-LD

DAEWOO	002	
DENON	012	
GOLDSTAR	004	
KENWOOD	003	
MAGNAVOX	010	
OPTIMUS	007	
PANASONIC	013	
PHILIPS	010	
POINNEER	000	009
RCA	006	
REALISTIC	007	
SAMSUNG	001	005
SHARP	003	011
TECHINCS	013	
TOSHIBA	003	
YAMAHA	008	

RX-773

AM/FM 4CHANNEL STEREO RECEIVER



5707-00000-104-0S

Free Manuals Download Website

<http://myh66.com>

<http://usermanuals.us>

<http://www.somanuals.com>

<http://www.4manuals.cc>

<http://www.manual-lib.com>

<http://www.404manual.com>

<http://www.luxmanual.com>

<http://aubethermostatmanual.com>

Golf course search by state

<http://golfingnear.com>

Email search by domain

<http://emailbydomain.com>

Auto manuals search

<http://auto.somanuals.com>

TV manuals search

<http://tv.somanuals.com>