

SHINDAIWA OWNER'S/OPERATOR'S MANUAL

SP415 BACK PACK SPRAYER



WARNING!

Minimize the risk of injury to yourself and others! Read this manual and familiarize yourself with the contents. Always wear eye protection, gloves and a respirator when operating this unit.



Part Number 80836 Rev. 1/04

shindaiwa®

Introduction

This manual contains information for the proper assembly, operation and care of your SP415 sprayer. Carefully read and follow the instructions contained in this manual before operating your sprayer.

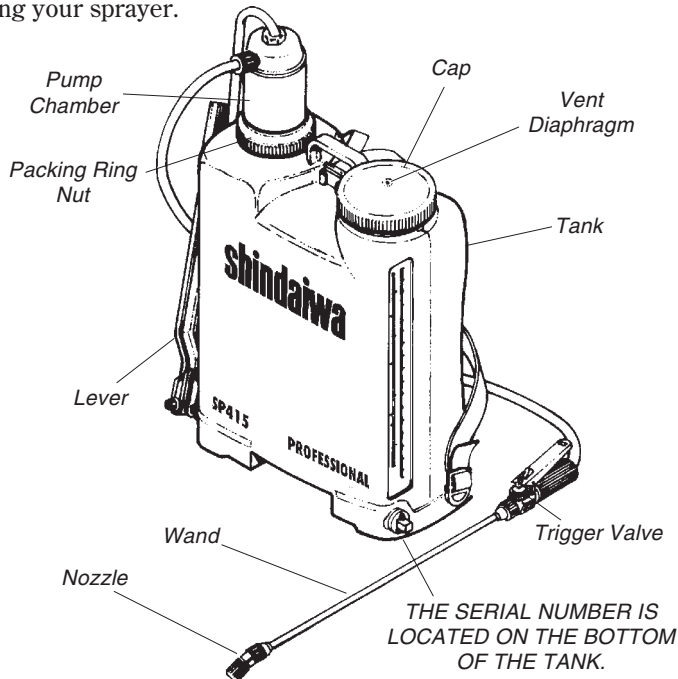

Specifications

Net Weight	10.5 pounds (4.8 kg)
Tank Capacity	4 U.S. gallons (15 liters)
Tank Material	Polyethylene (Plastic)
Fill Opening Diameter	4.5 inches (114 mm)
Pump	Piston Type
Pump Material	Polypropylene with UV Protector
Operating Pressure	15-90 psi (1.05-6.3 kg/sq. cm)
Wand Assembly Length	27.5 inches (698.5 mm)
Hose Length.....	69.75 inches (1771 mm)
Nozzle Installed	Red Adjustable Cone
Specifications subject to change without notice.	

Prepare to Assemble

Unpack the following items shipped in your sprayer box:

- Wand
- Pump Lever and Connecting Rod
- Tank Assembly
- Small Parts Kit
- From inside the sprayer tank, remove the plastic bag from the tank strainer.

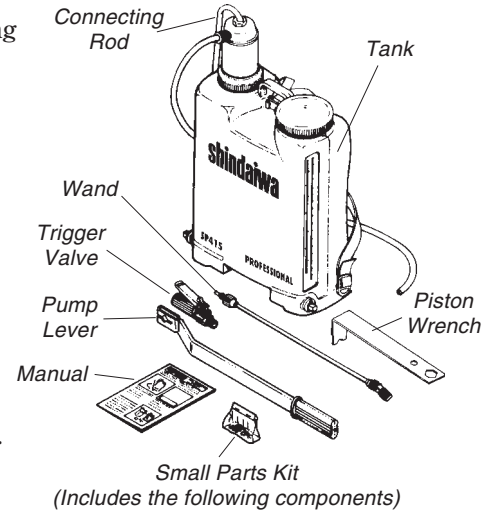

P/N	Description	Qty.
568970	Trigger Valve Needle Assembly	1
105254	Trigger Valve Cap	1
908905	Diaphragm	2
214585	45 x 12 Piston Cup	1
210088	No. 12 Disc	1
210195	Swirl Core	1
457416	Kematal DEF-06 Deflector Flat Fan Nozzle (Grey)	1
437885	Kematal 110-LD-03 Low Drift Flat Fan Nozzle (Blue)	1
217174	Stainless Steel Cone Nozzle	1
229724	Nozzle Cap	1

Install the Pump Lever

1. Align the pump lever with the pump shaft linkage as shown. (chamber side).
2. Install the pump lever on the pump shaft and secure with the lever bolt assembly.
3. Tighten the lever bolt until the lever clamp grips the pump shaft securely.

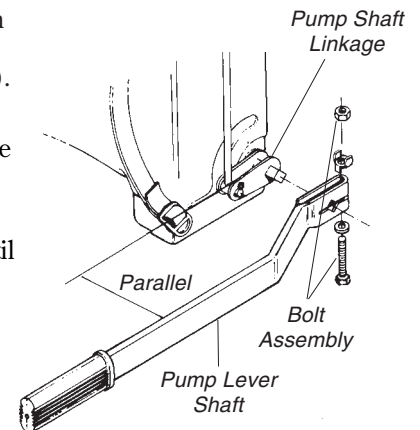

Assembling the Spray Wand

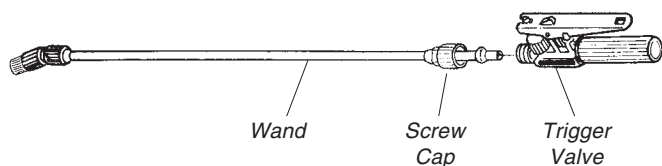

Push the wand into the trigger valve and secure with screw cap. Hand tighten to prevent leakage.

CAUTION!

Do not overtighten!

Adjusting the Shoulder Straps

Tightening

1. Place the sprayer on your back with the straps loosened.
2. Hold the adjustment ring firmly and pull until backpack is secure in place.

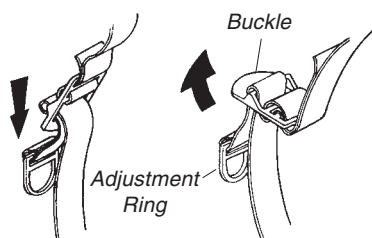

Loosening

Lift up on the buckle to release tension.

IMPORTANT!

After assembling the sprayer, fill the tank with clear water and lay it on its side. Check for leaks. Return sprayer to its upright position. Pump the lever 10-15 times and check for leaks. Most leaks can be stopped by tightening the appropriate connection or fitting. Any leaks must be stopped prior to filling the sprayer with chemicals.

Changing Lever Operating Side

NOTE:

The operating lever may be mounted on the left or right side of the sprayer tank depending on operator preference.

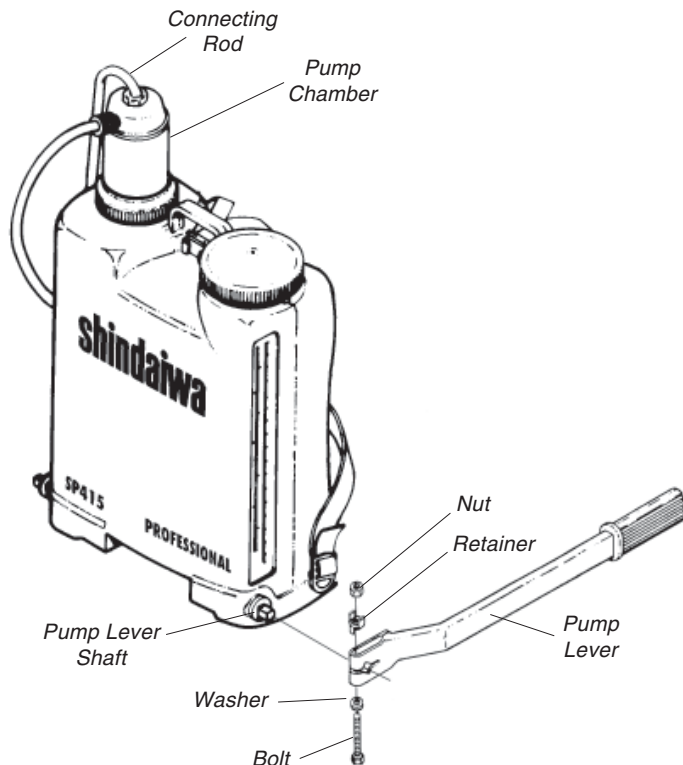

WARNING!

Remove all chemicals and wash the sprayer thoroughly before beginning to change the lever operating side.

1. Loosen the pump lever bolt and slide pump lever off of the pump shaft linkage.
2. Move the pump lever to the opposite side of the sprayer tank and install onto the pump lever shaft linkage as shown.

IMPORTANT!

Make sure that the pump lever is installed so that full up and down movement of the pump chamber is available.

3. Tighten pump lever bolt securely.

Safety Precautions



Carefully read the labels on chemical containers prior to use. Chemicals are classified in four categories of toxicity:

- Category I, High Toxicity, Red label
- Category II, Moderate Toxicity, Yellow label
- Category III, Low Toxicity, Blue label
- Category IV, Light Toxicity, Green label

There are unique handling recommendations for each category, and you should familiarize yourself with them.



Always wear clothing and safety equipment that will provide appropriate protection against the materials you are handling. Equipment may include, but not be limited to:

- Long sleeve shirt
- Impermeable apron or coverall
- Impermeable gloves and boots
- Wide-brim hat
- Protective mask equipped with appropriate filters



Do not eat, drink, or smoke while handling chemicals or while you are spraying. Always handle chemicals in a well ventilated area while wearing appropriate protective clothing and safety equipment. **DO NOT STORE OR TRANSPORT CHEMICALS WITH FOOD OR MEDICINES, AND NEVER REUSE A CHEMICAL CONTAINER FOR ANY OTHER PURPOSE.**



Keep chemicals out of the reach of children, animals, or other unauthorized people. When not in use, store chemicals in a safe place. Never blow through nozzles, valve, pipes or any other component by mouth!

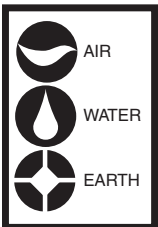

When handling chemicals and when spraying, make sure you are operating in accordance with local, state, and federal environmental protection rules and guidelines. Do not spray in very hot or windy conditions. **DO NOT POLLUTE THE ENVIRONMENT!**



After spray application, take a thoroughly cleansing shower using plenty of water and soap, then change into clean clothes. Protective clothing and safety gear should also be cleaned after each use. **IN CASE OF EXPOSURE TO DANGEROUS CHEMICALS, seek a physician immediately and be prepared to provide the label from the chemical container.**

Calibrating the Sprayer

(Requires optional flow calibrator bottle, P/N 646901)

1. Hold the wand at the working height and spray a test pattern to measure the application band width.
2. Based on the band width, identify from the table below the walking distance required to calibrate the sprayer.

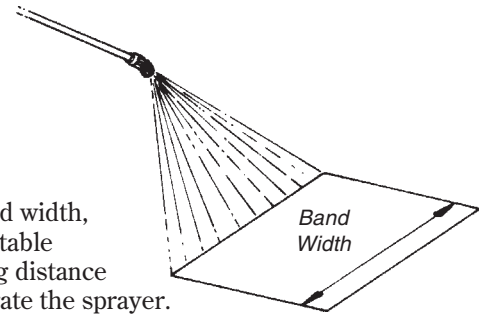

Band width	1.6 ft 0.5m	2.3 ft 0.7m	3.3 ft 1.0m	4.0 ft 1.2m	5.0 ft 1.5m
Distance to walk	165 ft 50.0m	120 ft 35.7m	80 ft 25.0m	70 ft 20.8m	55 ft 16.7m

3. Attach the flow calibrator bottle to the wand:
 - a. Remove the nozzle, cap and filter from the spray wand.
 - b. Mount the flow calibrator cover to the spray wand.
 - c. Reinstall the nozzle, filter and nozzle cap.
 - d. Screw the flow calibrator bottle into the cover.

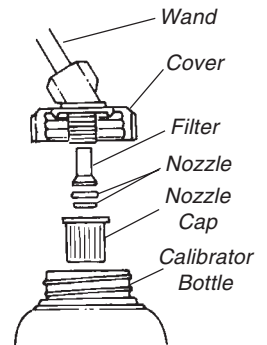

4. Using the flow calibrator bottle:
 - a. Operate the pump lever to maintain spray system pressure when using the flow calibrator bottle.
 - b. Hold the wand at your normal working position and spray into the bottle while walking the distance identified in step 2 above.
 - c. Place the bottle on a level surface and observe the liquid level visible through the side of the bottle. Match the liquid level to the 1/acre (liter per acre) scale on the calibration bottle.
 - d. Multiply the 1/acre (liter per acre) reading identified in step 4-c by .264 to determine your application coverage rate in gallons per acre.
 - e. Empty the bottle contents back into the sprayer tank.

NOTE:

For improved accuracy in calibrating your application coverage, repeat steps 4-a through 4-e and average the results.

Typical Nozzle Assemblies

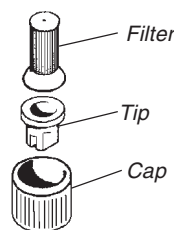

Flat Fan Nozzle

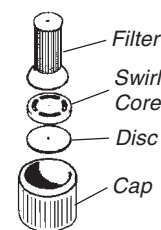



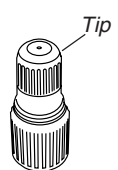

Cone Nozzle





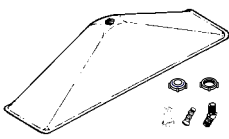
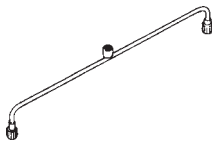
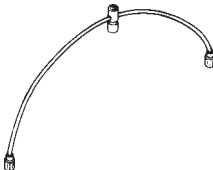
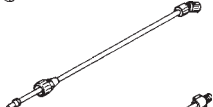
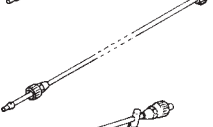

The spraying angle is changed by turning the tip





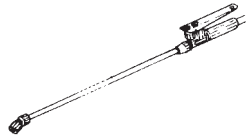
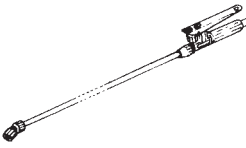

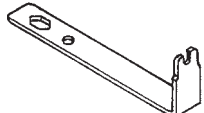
Adjustable Cone Nozzle

Optional Accessories

Part Number	Description
	761882 Spray hood is used for nonselective herbicides when spraying under windy conditions. Comes with Kematal 110-DEF-06 deflector fan nozzle and parts to assemble spray hood to your existing Shindaiwa spray wand.
	902296 Brass spray boom (27.5") for use with agrochemicals and foliar fertilizers applied to row crops. Provides 40" coverage. JD-12P cone nozzles and 40 mesh stainless steel filter included.
	907873 Flexible annealed copper boom fitted with three JD-12P cone nozzles. For use with agrochemicals and foliar fertilizers on row crops. Can be easily shaped as appropriate to provide proper coverage. 40 mesh stainless steel filter included.
	831107 Brass extension (11.8") complete with plastic fittings for extra reach. Attachable to original wand.
	728139 Brass extension (23.6") complete with plastic fittings for extra reach. Attachable to original wand.
	100016 Brass extension (6.3") complete with two JD-12P cone nozzles for doubling output of agrochemicals and foliar fertilizers on perennials. 40 mesh stainless steel filter included.
	646901 Flow calibrator bottle. For accurate calibration of backpack sprayers to prevent waste and damage to the environment.
	336115 Brass Y nozzle for use on plants requiring heavy applications of fungicides. Complete with two JD-12P cone nozzles, 40 mesh stainless steel filter and plastic fittings.

Part Number	Description
	838052 Constant pressure valve reduces pumping action, reduces drift and delivers uniform spraying. Improves productivity and saves chemicals.
	565648 Plastic anti-drip valve for agrochemicals and foliar fertilizer application. Attaches to wand and is compatible with any type of cone or flat fan nozzle.
	568774 Spray wand assembly (21.6") Plastic handle, trigger valve and spray tube. 40 mesh stainless steel nozzle and trigger valve filters included. Fitted with adjustable cone nozzle.
	725267 All brass spray wand assembly (21.6") for extra duty applications. Trigger valve and spray tube are brass. 40 mesh stainless steel nozzle and trigger valve filters included. Fitted with JD-12P cone nozzle.
	568816 Standard Repair Kit and Nozzle for SP415. Includes (1) Piston cup, trigger valve needle, trigger valve needle cap, JD-12P cone nozzle and disc, nozzle cap, deflector nozzle, flat fan nozzle, (2) diaphragms and o-ring.
	229724* Nozzle cap for attaching flat fan and cone type nozzles.
	452284 All Purpose Wrench for periodic maintenance and repair.

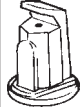
AVAILABLE SPRAY NOZZLES

Nozzle Type	Part Number	Application	Pressure psi (kg/cm ²)	Flow Rate gal (ml)/min	
	437756	Herbicides	45 (3.2)	0.16 (610)	
	437764				
	437772				
	717942	Agrochemicals and foliar fertilizers	45 (3.2)	0.08 (300)	
	217174*				0.16 (615)
	437855			45 (3.2)	0.22 (830)
	457317			45 (3.2)	0.33 (1250)
				457325	45 (3.2)
	457333			15 (1.0)	0.54 (2060)
	457390			15 (1.0)	0.25 (950)
				457408	15 (1.0)
	457416*			45 (3.2)	0.41 (1540)
	323725			45 (3.2)	0.08 (315)
		015024	45 (3.2)	0.17 (640)	
	325787	45 (3.2)	0.17 (640)		

* Denotes nozzles included in the SP415 standard repair kit.

Maintenance

Cleaning the Sprayer

After finishing the spray application, empty the sprayer and wash all equipment in an approved decontamination area.

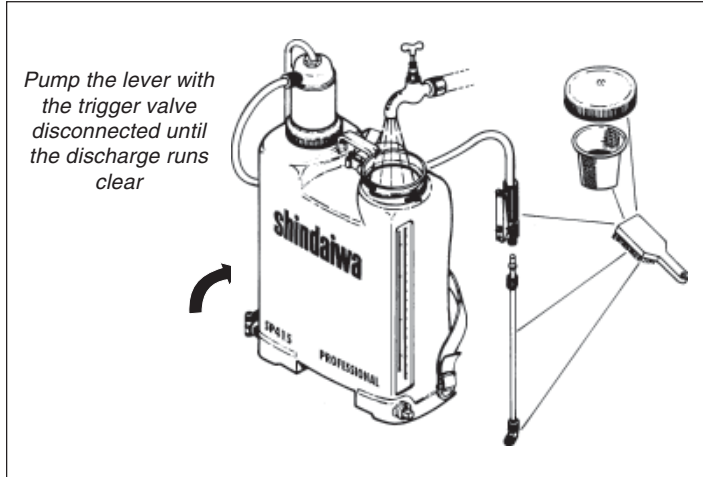

WARNING!

Remove all chemicals and wash before storing the sprayer. Chemical products have different reactions and can cause damage to the sprayer components and the environment. Unidentified chemicals left in the sprayer tank can pose a serious health threat to anyone servicing the unit and unaware of its presence!

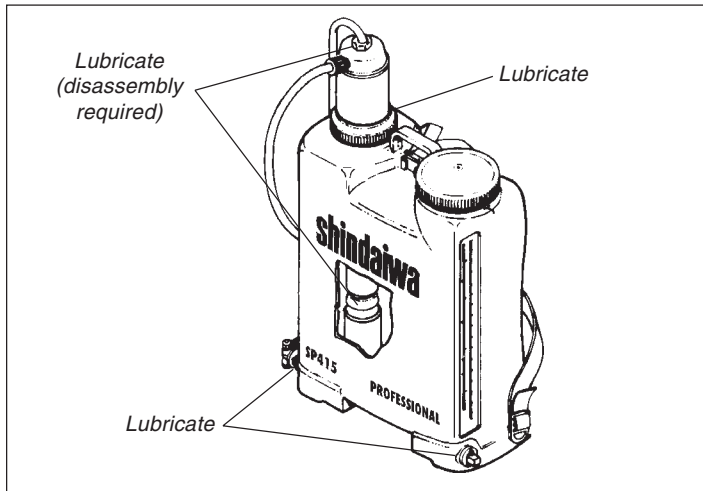

Periodically clean and lubricate the pump chamber and actuating linkage with a high quality lithium grease.

Pump Disassembly

1. Loosen the pump lever connecting rod nut and remove the connecting rod from the chamber. Loosen the packing ring nut that secures the chamber to the tank. Remove the tank lid and strainer, reach inside the tank and remove the agitator from the pump chamber, then remove the chamber from the cylinder.

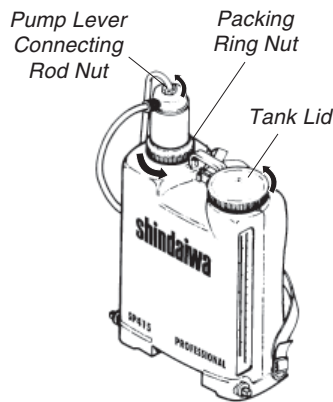

Pump Disassembly (cont.)

2. Using the 452284 all-purpose wrench, remove the piston cup fastener and cup. Replace piston cup as necessary.
5. From the bottom of the piston cup fastener, push the diaphragm out towards the top.
4. Remove the two Phillips head screws and washers located at the bottom of the cylinder and remove the cylinder base.
5. From the bottom of the cylinder, push the diaphragm out towards the top of the cylinder.
7. Clean all parts and carefully inspect for worn or damaged parts and replace as necessary.
8. Reassemble in the reverse order.

NOTE:
Lubricating diaphragms and all moving parts with a high quality lithium grease will ease assembly and prolong the life of the unit.

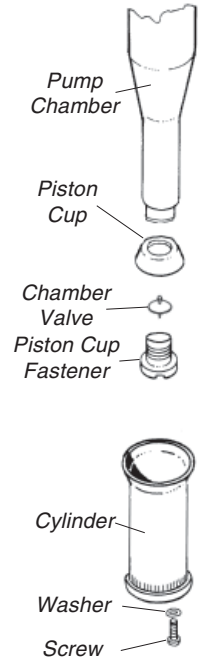

Troubleshooting: Lack of Pressure

SYMPTOM	CAUSE	REMEDY
Leakage through the upper cylinder.	Worn or dried out piston cup.	Lubricate or replace the piston cup.
After pumping and pressurizing the chamber, the pump lever drops rapidly when released.	Cylinder diaphragm not sealing properly due to wear or impurities.	Clean or replace the cylinder diaphragm.
After pumping and pressurizing the chamber, the pump lever rises slowly when released.	Chamber diaphragm not sealing properly due to wear or impurities.	Clean or replace the chamber diaphragm.
Low pressure and pump lever hard to operate.	Pump chamber filled with liquid.	Tighten screw cap at top of chamber. With an empty tank, pump lever with trigger valve open until all liquid is purged from pump.

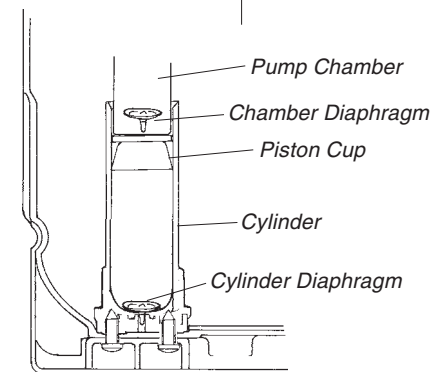

Shindaiwa Limited Warranty

Shindaiwa Inc. manufactures its products to superior standards of quality to ensure customers obtain the highest level of satisfaction. In keeping with this goal, Shindaiwa Inc. warrants the SP415 sprayer to the original purchaser as follows:

Warranty Period

One year from the delivery date to the original purchaser for consumer and commercial applications.

90 days for rental applications.

Warranty Administration

Within the covered warranty period, Shindaiwa Inc. will, at their option, repair or replace any defect in material or workmanship, without charge for parts or labor, if this product is presented at an authorized Shindaiwa dealer.

Warranty Exclusions and Limitations

Shindaiwa Inc. assumes no responsibility for damages, loss, or injury resulting from:

- Normal wear and tear
- Misuse or neglect
- Modifications to or removal of original component parts

The warranty is limited to the terms stated herein. Shindaiwa Inc. disclaims all liability for incidental or consequential damages. Some states do not allow the exclusion of incidental or consequential damages, so these limitations may not apply to you.

This warranty give you specific legal rights, and you may also have other rights which may vary from state to state.

Shindaiwa reserves the right to change the design or specifications of this product without obligation to modify previously manufactured products.

Owner's Responsibilities

The owner of the sprayer must demonstrate reasonable care in the use, maintenance, and storage of this Shindaiwa product. If a warrantable failure should occur, the owner must deliver the product to an authorized Shindaiwa servicing dealer for correction. All residual chemicals must be flushed from the sprayer prior to delivery.

Unidentified chemicals left in the sprayer tank can pose a serious health threat to anyone servicing the unit and unaware of its presence!

To obtain warranty service, proof of purchase must be presented to the authorized Shindaiwa servicing dealer when the product is presented for repairs.

Proof of purchase must include date of purchase and the name and address of the selling dealer.

Illustrated Parts List (SP415) After s/n 198698C4

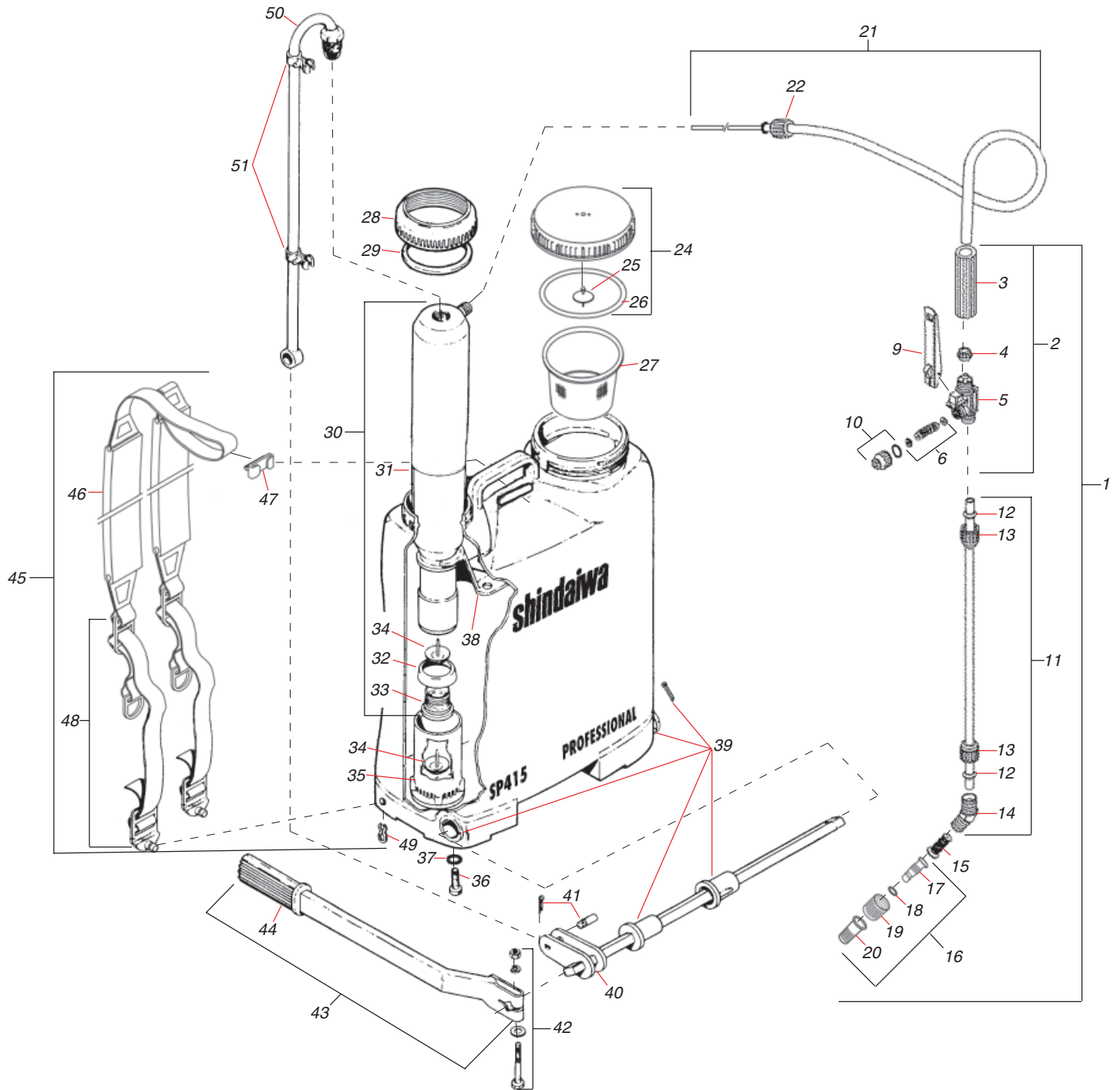

Illustrated Parts List (SP415)

No.	Part Number	ItemDescription	Qty.
1	568774	Spray Wand Assembly	1
2	568782	Trigger Valve Assembly	1
3	909192	Trigger Valve Handle	1
4	920470	Hose Ferrule	1
5	909283	Trigger Valve Body	1
6	105239	Trigger Valve Needle Assembly	1
9	568972	Trigger	1
10	996058	Valve Cap	1
11	568873	Wand Tube/Elbow Assembly	1
12	909309	Cone Packing	2
13	915744	Cone Nut	2
14	635276	Elbow	1
15	592139	Nozzle Filter (40 mesh)	1
16	015024	Adjustable Cone Nozzle Assembly	1
17	166611	Nozzle Body	1
18	940106	Packing Ring, (ORI-009)	1
19	229724	Nozzle Cap	1
20	166637	Nozzle Cap, Adjustable (Red)	1
21	048116	Dip Tube W/Hose	1
22	942193	Nut, 20 x 1.5	1
24	878132	Lid Assembly	1
25	560573	Diaphragm, NBR Rubber	1
26	837922	Lid Seal	1
27	942920	Strainer	1
28	560672	Packing Ring Nut	1
29	560581	Packing Ring	1
30	087163	Chamber Assembly	1
31	990010	Chamber Body	1
32a	568535	Piston Cup	1
32b	214585	Piston Cup, Santoprene (Optional)	1
33	630749	Piston Cup Fastener	1
34	964270	Diaphragm, Viton®	1
35	630731	Cylinder	1
34	964270	Diaphragm, Viton®	1
36	336503	Self-tapping Screw (14 x 7/8)	2
37	229864	Seal Washer	2
38	214619	Agitator	1
39	630756	Bushings Set	1
40	214627	Pump Lever Shaft	1
41	925826	Pin Set	1
42	925818	Bolt Assembly	1
43	630723	Pump Lever Assembly	1
44	002683	Hand Grip	1
45	568717	Strap Assembly	1
46	568725	Shoulder Pads	1
47	214817	Shoulder Strap Lock	1
48	229286	Strap Buckle Set	1
49	120154	Strap Buckle Lock	2
50	214486	Pump Rod Assy.	1
51	925800	Wand Clamp Set	1

Illustrated Parts List (SP415) Before s/n 198697L3

Item	Part No.	Description	Qty.
01	214486	Pumping Rod Ass'y	1
02	925800	Spray Wand Holder Set	1
03	942136	Chamber Cover	1
04	120303	Gasket Holder	1
05	552703	Gasket	1
06	120055	Ring ORI-36	2
07	942235	Chamber Body	1
08	568717	Strap Assembly (includes Items 10 and 15)	1
09	214619	Agitator	1
10	568725	Shoulder Pads	2
11	908905	Diaphragm	3
12	568535	Piston Cup, 45 x 12	1
13	630749	Piston Cup Fastener with Diaphragm	1
14	630731	Cylinder w/ Diaphragm	1
15	229286	Strap Buckle Set (supplied with 2 locks)	1
16	120154	Lock	2
17	002683	Handgrip	1
18	630723	Pumping Lever (supplied with Items 17 and 18)	1
19	925818	Bolt Assembly	1
20	925826	Pin with Cotter Pin	1
21	214627	Pumping Lever Shaft	1
22	336503	Self-tapping Screw, 14 x 7/8"	2
23	630756	Bushings Set	1
24	214817	Carrying Straps Lock	1
25	942219	Chamber Assembly	1
26	942359	Dip Tube Assembly	1
27	942193	Nut, 20 x 1.5	1
28	654921	Cap with Diaphragm	1
—	560573	Cap Diaphragm	1
29	942920	Strainer	1
30	568634	Tank with Cap	1
—	568642	Tank only	1
31	568972	Trigger	1
32	352577	Lower Seal, 30 x 88 x 25	1
33	351585	Upper Seal, 50 x 96 x 35	1
34	105254	Trigger Valve Cap	1
35	568790	Trigger Valve Needle Assembly (includes Items 32 and 33)	1

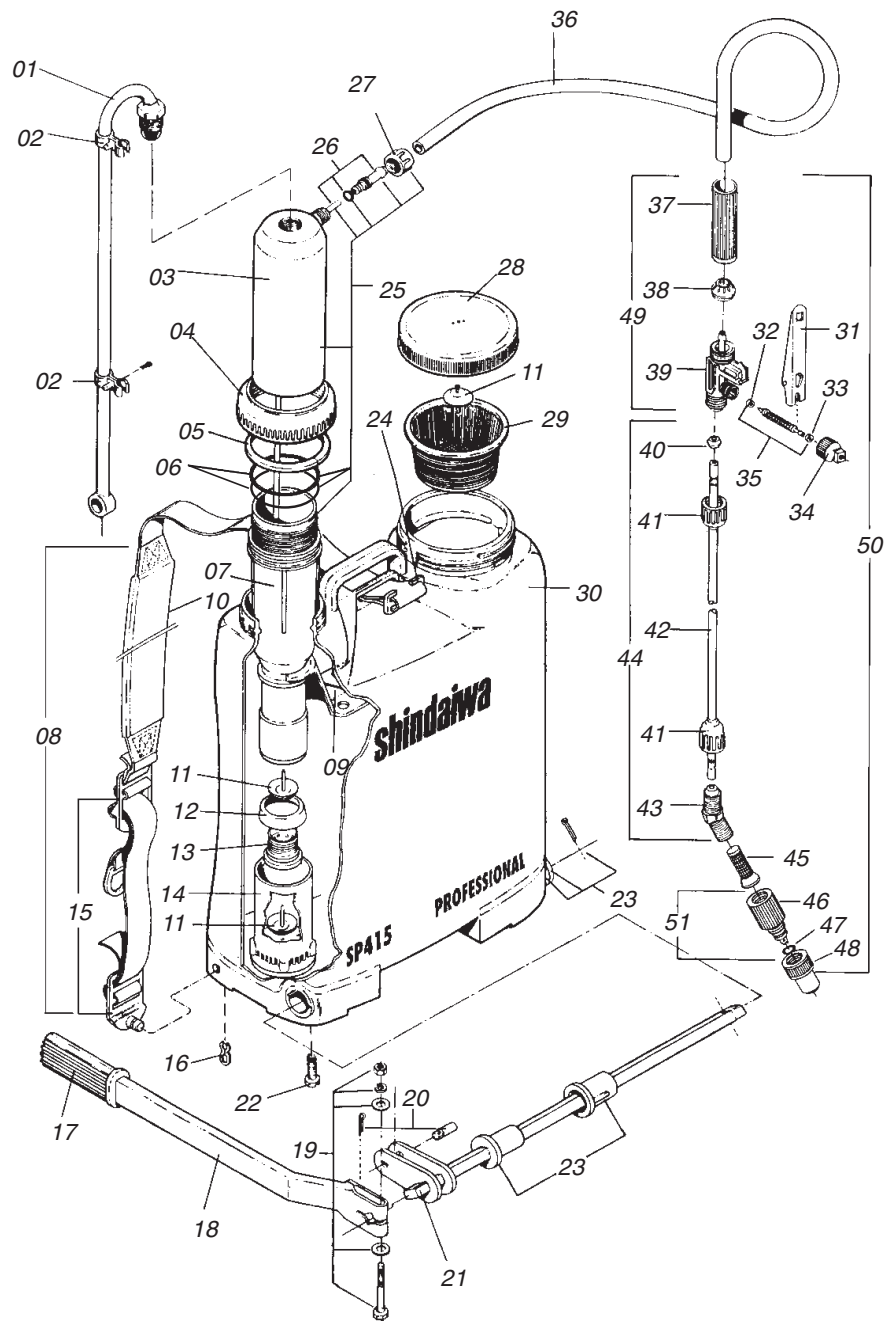

Item	Part No.	Description	Qty.
36	530576	Hose, 5.6" x 1350	1
37	909192	Trigger Valve Handle	1
38	920470	Lock	1
39	909283	Trigger Valve Body	1
40	909309	Cone Packing	1
41	915744	Screw Cap	2
42	336263	Spray Tube	1
43	560649	Elbow Assembly	1
44	568873	Spray Tube Assembly (includes Items 40, 41, 42 [2], and 43)	1
45	730366	40 Mesh Nozzle Filter	1

Item	Part No.	Description	Qty.
46	009456	Nozzle Body	1
47	715052	Packing Ring, ORI-012	1
48	009464	Nozzle Cap (red)	1
49	568782	Trigger Valve Assembly (includes Items 31, 34, 35, 37, 38 and 39)	1
50	568774	Spray Wand Ass'y (includes Items 44 and 49)	1
51	015024	Adjustable Cone Nozzle (w/ Items 46, 47 and 48)	1



shindaiwa®

Shindaiwa Inc.
11975 S.W. Herman Road
Tualatin, Oregon 97062
Telephone: 503 692-3070
Fax: 503 692-6696
www.shindaiwa.com

©2004 Shindaiwa, Inc.
Part Number 80836
Revision 2/04

Shindaiwa is a registered trademark
of Shindaiwa, Inc.
Specifications subject to change without notice.
Printed in Brazil

Free Manuals Download Website

<http://myh66.com>

<http://usermanuals.us>

<http://www.somanuals.com>

<http://www.4manuals.cc>

<http://www.manual-lib.com>

<http://www.404manual.com>

<http://www.luxmanual.com>

<http://aubethermostatmanual.com>

Golf course search by state

<http://golfingnear.com>

Email search by domain

<http://emailbydomain.com>

Auto manuals search

<http://auto.somanuals.com>

TV manuals search

<http://tv.somanuals.com>