

## SHINDAIWA OWNER'S/OPERATOR'S MANUAL

# SP300 BACK PACK SPRAYER



### WARNING!

Minimize the risk of injury to yourself and others! Read this manual and familiarize yourself with the contents. Always wear eye protection, gloves and a respirator when operating this unit.



Part Number 80709 Rev. 6/02

# shindaiwa®

## Introduction

This manual contains information for the proper assembly, operation and care of your SP300 backpack sprayer. Carefully read and follow the instructions contained in this manual before operating your sprayer.

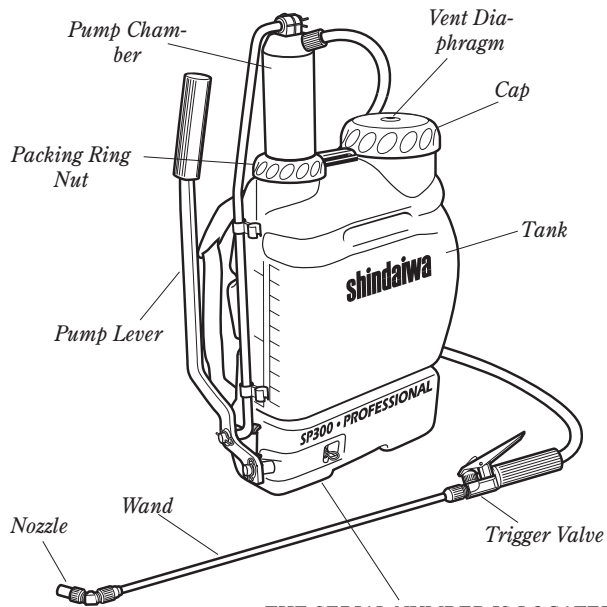

THE SERIAL NUMBER IS LOCATED ON THE BOTTOM OF THE TANK.

## Specifications

Net Weight.....	8.4 pounds (3.8 kg)
Tank Capacity.....	3.0 U.S. gallons (11.4 liters)
Tank Material.....	Polyethylene
Fill Opening Diameter.....	4.5 inches (114 mm)
Pump Type/Material.....	Piston/Plastic
Operating Pressure.....	15-65 psi (1.05-4.6 kg/sq. cm)
Wand Assembly Length.....	27.5 inches (699 mm)
Hose Length.....	69.75 inches (1771 mm)
Nozzle Installed.....	Red Adjustable Cone

Specifications subject to change without notice.

## Prepare to Assemble

Unpack the following items shipped in your sprayer box:

- Wand
- Pump Lever
- Tank Assembly and Connecting Rod
- Small Parts Kit
- From inside the sprayer tank, remove the plastic bag from the tank strainer.

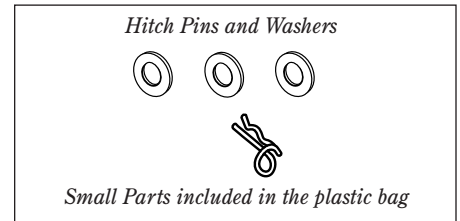
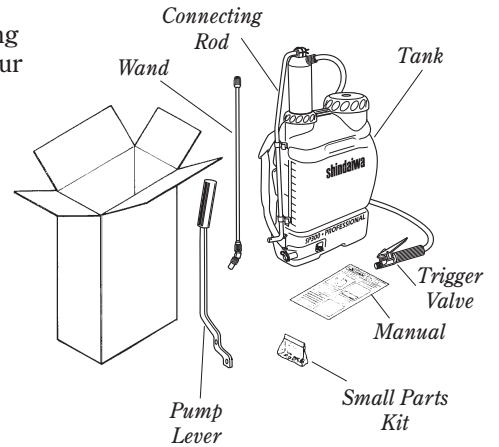

## Install the Pump Lever

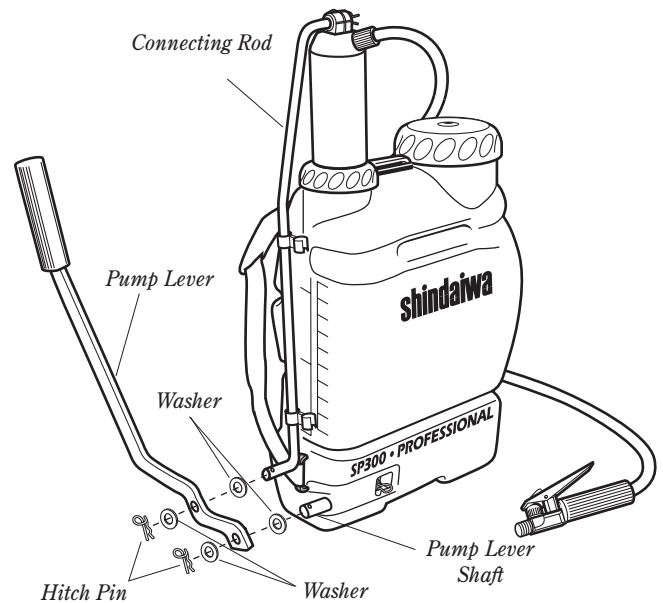

1. Remove the hitch pin from the pump lever shaft.
2. Install a flat washer on the connecting rod.
3. Lightly grease the holes in the pump lever and assemble on to the pump lever shaft and connecting rod. Secure with flat washers and hitch pins.

## Assembling the Spray Wand

---

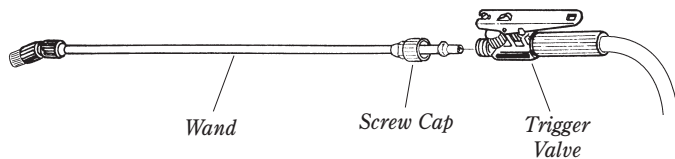

Push the wand into the trigger valve and secure with screw cap. Hand tighten to prevent leakage.

### **CAUTION!**

Do not overtighten!

## Adjusting the Shoulder Straps

---

### **Tightening**

1. Place the sprayer on your back with the straps loosened.
2. Hold the adjustment ring firmly and pull until backpack is secure in place.

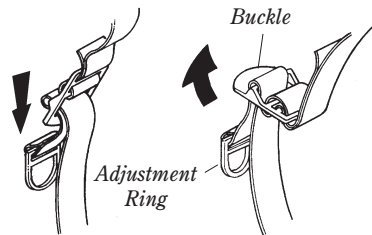

### **Loosening**

Lift up on the buckle to release tension.

### **IMPORTANT!**

After assembling the sprayer, fill the tank with clear water and lay it on its side. Check for leaks. Return sprayer to its upright position. Pump the lever 10-15 times and check for leaks. Most leaks can be stopped by tightening the appropriate connection or fitting. Any leaks must be stopped prior to filling the sprayer with chemicals.

---

## Safety Precautions



Carefully read the labels on chemical containers prior to use. Chemicals are classified in four categories of toxicity:

- Category I, High Toxicity, Red label
- Category II, Moderate Toxicity, Yellow label
- Category III, Low Toxicity, Blue label
- Category IV, Light Toxicity, Green label

There are unique handling recommendations for each category, and you should familiarize yourself with them.



Always wear clothing and safety equipment that will provide appropriate protection against the materials you are handling. Equipment may include, but not be limited to:

- Long sleeve shirt
- Impermeable apron or coverall
- Impermeable gloves and boots
- Wide-brim hat
- Protective mask equipped with appropriate filters



Do not eat, drink, or smoke while handling chemicals or while you are spraying. Always handle chemicals in a well ventilated area while wearing appropriate protective clothing and safety equipment. **DO NOT STORE OR TRANSPORT CHEMICALS WITH FOOD OR MEDICINES, AND NEVER REUSE A CHEMICAL CONTAINER FOR ANY OTHER PURPOSE.**



Keep chemicals out of the reach of children, animals, or other unauthorized people. When not in use, store chemicals in a safe place. Never blow through nozzles, valve, pipes or any other component by mouth!

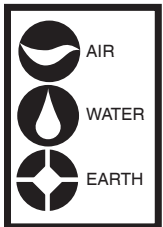

When handling chemicals and when spraying, make sure you are operating in accordance with local, state, and federal environmental protection rules and guidelines. Do not spray in very hot or windy conditions. **DO NOT POLLUTE THE ENVIRONMENT!**



After spray application, take a thoroughly cleansing shower using plenty of water and soap, then change into clean clothes. Protective clothing and safety gear should also be cleaned after each use. **IN CASE OF EXPOSURE TO DANGEROUS CHEMICALS, seek a physician immediately and be prepared to provide the label from the chemical container.**

## Calibrating the Sprayer

(Requires optional flow calibrator bottle, P/N 646901)

1. Hold the wand at the working height and spray a test pattern to measure the application band width.
2. Based on the band width, identify from the table below the walking distance required to calibrate the sprayer.

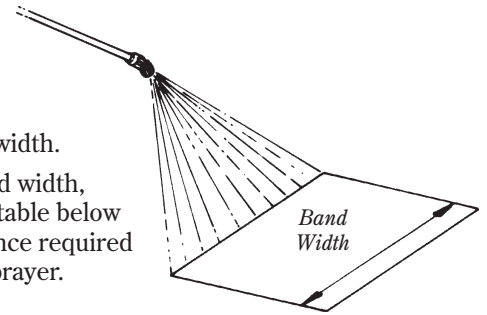

Band width	1.6 ft 0.5m	2.3 ft 0.7m	3.3 ft 1.0m	4.0 ft 1.2m	5.0 ft 1.5m
Distance to walk	165 ft	120 ft	80 ft	70 ft	55 ft

3. Attach the flow calibrator bottle to the wand:
  - a. Remove the nozzle, cap and filter from the spray wand.
  - b. Mount the flow calibrator cover to the spray wand.

- c. Reinstall the nozzle, filter and nozzle cap.
  - d. Screw the flow calibrator bottle into the cover.

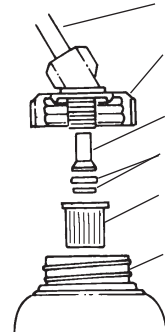

4. Using the flow calibrator bottle:

- a. Operate the pump lever to maintain spray system pressure when using the flow calibrator bottle.
  - b. Hold the wand at your normal working position and spray into the bottle while walking the distance identified in step 2 above.
  - c. Place the bottle on a level surface and observe the liquid level visible through the side of the bottle. Match the liquid level to the 1/acre (liter per acre) scale on the calibration bottle.
  - d. Multiply the 1/acre (liter per acre) reading identified in step 4-c by .264 to determine your application coverage rate in gallons per acre.
  - e. Empty the bottle contents back into the sprayer tank.

### NOTE:

For improved accuracy in calibrating your application coverage, repeat steps 4-a through 4-e and average the results.

## Typical Nozzle Assemblies

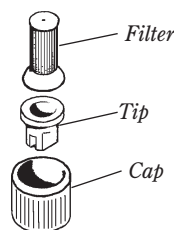

Flat Fan Nozzle

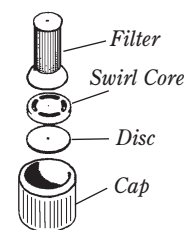



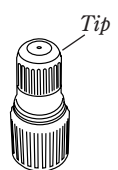

Cone Nozzle





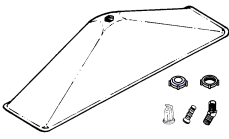
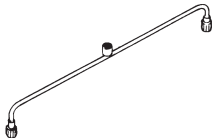
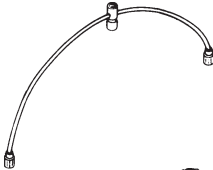

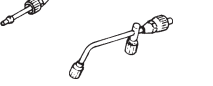
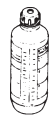
The spraying angle is changed by turning the tip





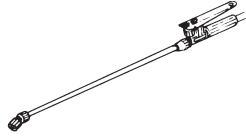
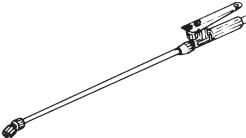
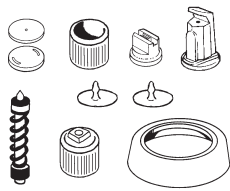

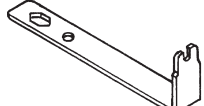
Adjustable Cone Nozzle

## Optional Accessories

Part Number	Description
	<b>761882</b> Spray hood is used for nonselective herbicides when spraying under windy conditions. Comes with Kematal 110-DEF-06 deflector fan nozzle and parts to assemble spray hood to your existing Shindaiwa spray wand.
	<b>902296</b> Brass spray boom (27.5") for use with agrochemicals and foliar fertilizers applied to row crops. Provides 40" coverage. JD-12P cone nozzles and 40 mesh stainless steel filter included.
	<b>907873</b> Flexible annealed copper boom fitted with three JD-12P cone nozzles. For use with agrochemicals and foliar fertilizers on row crops. Can be easily shaped as appropriate to provide proper coverage. 40 mesh stainless steel filter included.
	<b>831107</b> Brass extension (11.8") complete with plastic fittings for extra reach. Attachable to original wand.
	<b>728139</b> Brass extension (23.6") complete with plastic fittings for extra reach. Attachable to original wand.
	<b>100016</b> Brass extension (6.3") complete with two JD-12P cone nozzles for doubling output of agrochemicals and foliar fertilizers on perennials. 40 mesh stainless steel filter included.
	<b>646901</b> Flow calibrator bottle. For accurate calibration of backpack sprayers to prevent waste and damage to the environment.
	<b>336115</b> Brass Y nozzle for use on plants requiring heavy applications of fungicides. Complete with two JD-12P cone nozzles, 40 mesh stainless steel filter and plastic fittings.

Part Number	Description
	<b>838052</b> Constant pressure valve reduces pumping action, reduces drift and delivers uniform spraying. Improves productivity and saves chemicals.
	<b>565648</b> Plastic anti-drip valve for agrochemicals and foliar fertilizer application. Attaches to wand and is compatible with any type of cone or flat fan nozzle.
	<b>568774</b> Spray wand assembly (21.6") Plastic handle, trigger valve and spray tube. 40 mesh stainless steel nozzle and trigger valve filters included. Fitted with adjustable cone nozzle.
	<b>725267</b> All brass spray wand assembly (21.6") for heavy-duty applications. Trigger valve and spray tube are brass. 40 mesh stainless steel nozzle and trigger valve filters included. Fitted with JD-12P cone nozzle.
	<b>568816</b> Standard Field Repair & Nozzle Kit for SP300/SP415. Includes: Piston cup, (2) diaphragm valves, trigger valve needle assembly, trigger valve cap, JD-12P cone nozzle, nozzle cap, blue flat fan nozzle, and grey deflector nozzle.
	<b>229724*</b> Nozzle cap for attaching flat fan and cone type nozzles.
	<b>452284</b> All Purpose Wrench for periodic maintenance and repair.

## AVAILABLE SPRAY NOZZLES

Nozzle Type	Part Number	Application	Pressure psi (kg/cm <sup>2</sup> )	Flow Rate gal (ml)/min	
	437756	Herbicides	45 (3.2)	0.16 (610)	
	437764			0.21 (810)	
	437772			0.33 (1250)	
	717942	Agrochemicals and foliar	45 (3.2)	0.08 (300)	
	217174*			0.16 (615)	
	437855			0.16 (615)	
	457317			0.22 (830)	
	457325			0.44 (1680)	
	457333			15 (1.0)	0.54 (2060)
	457390			15 (1.0)	0.25 (950)
	457408			15 (1.0)	0.32 (1200)
	457416*			45 (3.2)	0.41 (1540)
				323725	Yellow
015024		Red	0.17 gpm @ 45 psi.	45 (3.2)	
325787		Blue	0.18 gpm @ 45 psi.	45 (3.2)	

\* Denotes parts included in the SP300 repair kit. **Note:** All Shindaiwa sprayers come with the red adjustable cone nozzle P/N 015024 installed as standard equipment.

# Maintenance

## Cleaning the Sprayer

After finishing the spray application, empty the sprayer and wash all equipment in an approved decontamination area.

Relieve all pressure from the pump prior to disassembly or storage.

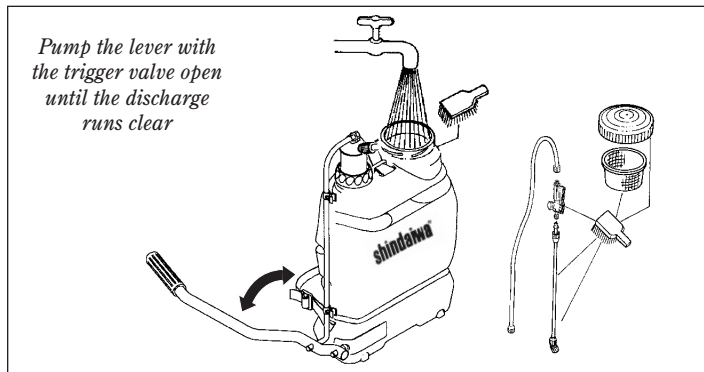

**WARNING!**

Remove all chemicals and wash before storing the sprayer. Chemical products have different reactions and can cause damage to the sprayer components and the environment. Unidentified chemicals left in the sprayer tank can pose a serious health threat to anyone servicing the unit and unaware of its presence!

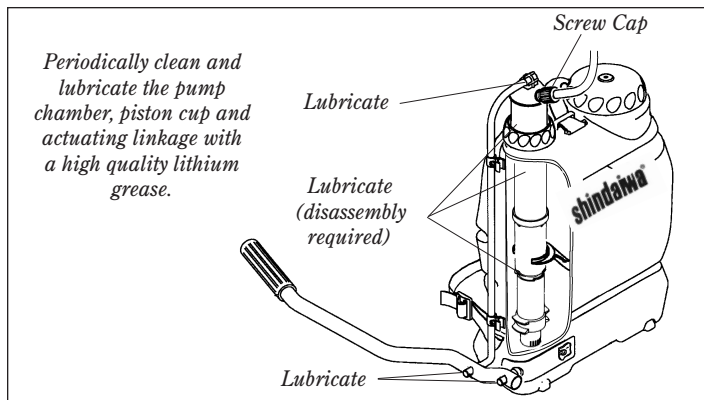

## Troubleshooting: Lack of Pressure

SYMPTOM	CAUSE	REMEDY
Leakage through the upper cylinder.	Worn or dried out piston cups.	Lubricate or replace the piston cups.
After pumping and pressurizing the chamber, the pump lever drops rapidly when released.	Cylinder diaphragm valve not sealing properly due to wear or impurities.	Clean or replace the cylinder diaphragm valve.
After pumping and pressurizing the chamber, the pump lever rises slowly when released.	Chamber diaphragm valve not sealing properly due to wear or impurities.	Clean or replace the chamber diaphragm valve.
Low pressure and pump lever hard to operate.	Pump chamber filled with liquid.	Tighten screw cap at top of chamber. With an empty tank, pump lever with trigger valve open until all liquid is purged from pump.

## Pump Disassembly

1. Remove the pump-lever connecting rod from the pump chamber.
2. Remove lid and slide agitator off pump chamber.
3. Loosen the packing ring nut that secures the chamber to the tank, then push the chamber into the cylinder all the way and lock tabs together.
4. Turn the pump chamber 90° to unlock the cylinder from the tank.
5. Separate the pump cylinder from the pump chamber and pull the pump chamber out of the tank. Remove the cylinder through the tank fill opening.
6. Remove the piston cup fastener from the chamber valve assy. using the 452284 maintenance tool. See page 6.
7. If required, remove cylinder diaphragm valve with a small screw driver or similar object as shown in figure below.
8. Clean or replace parts that are excessively worn.

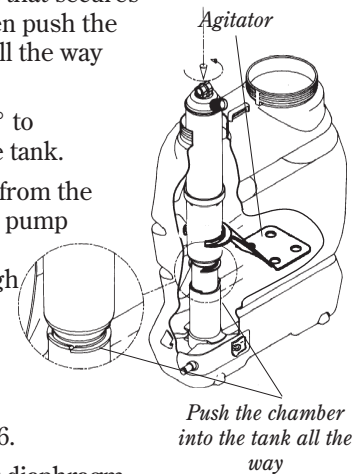

## Assembly

1. Install the diaphragm valve in the cylinder and secure it using the installation tool. See figure below.
2. Assemble the piston cup fastener to chamber assembly.
3. To ease assembly and help prevent premature wear, lightly lubricate the piston cup with lithium-base grease. Insert the cylinder into the tank. Push the pump chamber into the cylinder and lock the tabs.
4. Using the pump chamber, place the cylinder into its location in the tank. Turn the pump chamber 90° until the cylinder locks in place.
5. Reassemble the pump-lever connecting rod to the pump chamber.
6. Tighten the packing ring nut that secures the pump chamber to the tank.

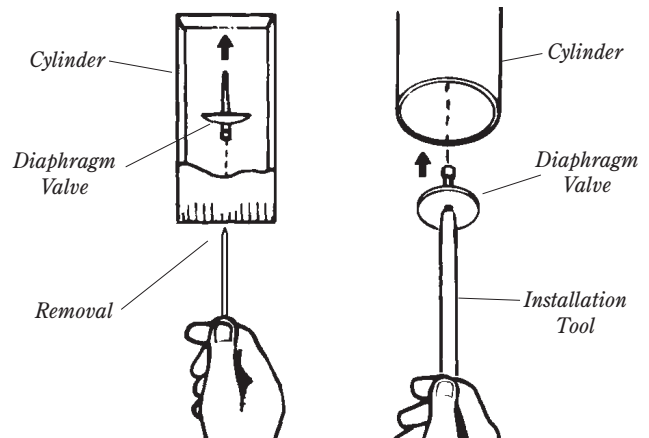
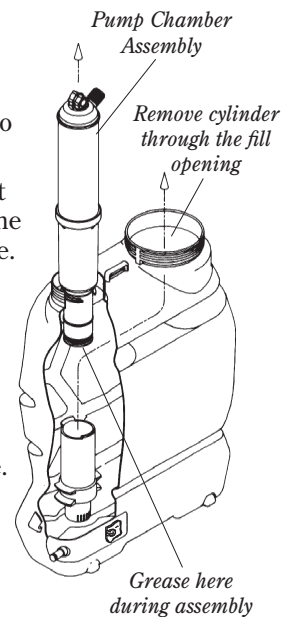

# Shindaiwa Limited Warranty

# NOTES

Shindaiwa Inc. manufactures its products to superior standards of quality to ensure customers obtain the highest level of satisfaction. In keeping with this goal, Shindaiwa Inc. warrants the SP300 sprayer to the original purchaser as follows:

**Warranty Period**

One year from the delivery date to the original purchaser for consumer and commercial applications.  
90 days for rental applications.

**Warranty Administration**

Within the covered warranty period, Shindaiwa Inc. will, at their option, repair or replace any defect in material or workmanship, without charge for parts or labor, if this product is presented at an authorized Shindaiwa dealer.

**Warranty Exclusions and Limitations**

Shindaiwa Inc. assumes no responsibility for damages, loss, or injury resulting from:

- Normal wear and tear
- Misuse or neglect
- Modifications to or removal of original component parts

The warranty is limited to the terms stated herein. Shindaiwa Inc. disclaims all liability for incidental or consequential damages. Some states do not allow the exclusion of incidental or consequential damages, so these limitations may not apply to you.

This warranty give you specific legal rights, and you may also have other rights which may vary from state to state.

Shindaiwa reserves the right to change the design or specifications of this product without obligation to modify previously manufactured products.

**Owner's Responsibilities**

The owner of the sprayer must demonstrate reasonable care in the use, maintenance, and storage of this Shindaiwa product. If a warrantable failure should occur, the owner must deliver the product to an authorized Shindaiwa servicing dealer for correction. All residual chemicals must be flushed from the sprayer prior to delivery.

**Unidentified chemicals left in the sprayer tank can pose a serious health threat to anyone servicing the unit and unaware of its presence!**

To obtain warranty service, proof of purchase must be presented to the authorized Shindaiwa servicing dealer when the product is presented for repairs.

---

---

---

---

---

---

---

---

---

---

---

---

---

---

---

---

---

---

---

---

---

---

---

---

# Illustrated Parts List (SP300 Through Serial Number 913170H2)

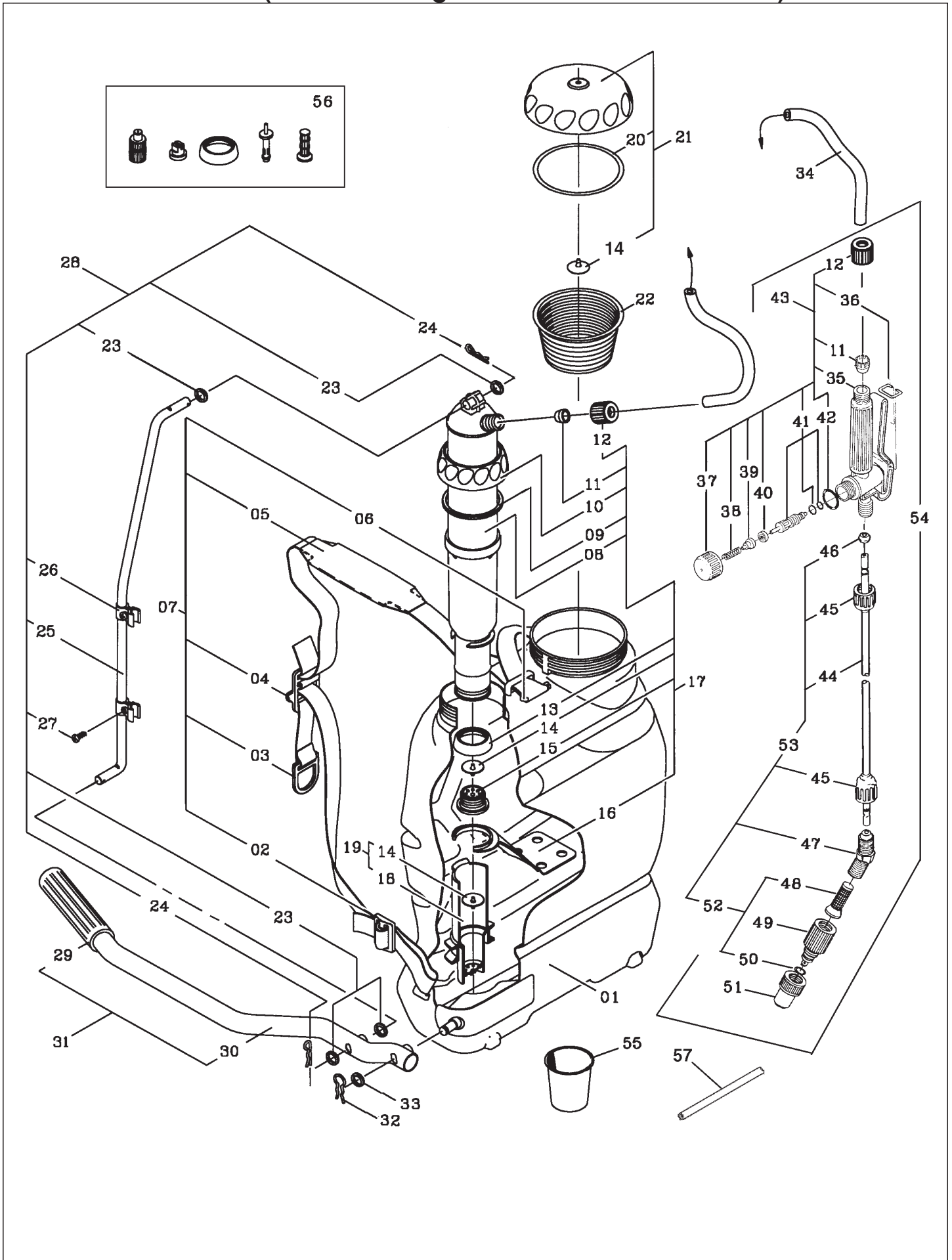



## Illustrated Parts List (SP300 Through Serial Number 913170H2)

No.	Part Number	ItemDescription	Qty.
1	965384	Tank-SP300	1
2	502757	Shoulder strap buckle	2
3	965194	Lower strap assembly	2
4	120691	Shoulder strap buckle	2
5	965426	Upper strap w/pad	1
6	965368	Shoulder strap retaining clip	1
7	965418	Shoulder strap assembly	1
8	965319	Chamber body	1
9	965317	Chamber packing ring (Viton)	1
10	965335	Packing nut ring	1
11	661330	Hose ferrule	1
12	942193	Screw cap S-20	2
13	568535	Piston cup	1
14	560573	Diaphragm valve	3
15	214577	Piston cup fastener	1
16	214619	Mechanical agitator	1
17	965202	Chamber assembly complete	1
18	965301	Cylinder	1
19	965228	Cylinder assembly (14 & 18)	1
20	965350	O-ring cap seal ORI - 245	1
21	965210	Tank cap with seal and diaphragm	1
22	647123	Strainer	1
23	609438	Flat washer	4
24	942904	Retaining Clip	2
25	965293	Pump lever connecting rod	1
26	838003	Spray wand holding clip	2
27	942425	Screw 3.5 x 16 mm	2
28	965244	Pump lever connecting rod assembly	1
29	002683	Hand grip	1
30	965285	Pump lever	1
31	965277	Pump lever assembly (29 & 30)	1
32	965269	Retaining clip	1
33	965251	Flat washer	1
34	635326	Hose	1
35	229757	Trigger valve body w/handle	1
36	229773	Trigger valve lock	1
37	229732	Trigger valve cap	1
38	904284	Compression spring	1
39	433730	Valve seat base	1
40	351536	Valve seat	1
41	229740	Trigger needle valve assembly	1
42	229781	O-ring ORI - 019	1
43	635847	Trigger valve assembly	1
44	336263	Spray wand tube	1
45	915744	Screw cap	2
46	909309	Wand ferrule	2
47	560649	Spray wand nozzle elbow	1
48	730366	Nozzle filter (40 mesh)	1
49	009456	Nozzle Body	1
50	715052	"O-ring, ORI-012 (Viton)"	1
51	009464	Nozzle cap (red)	1
52	015024	"Adjustable cone nozzle (49, 50 & 51)"	1
53	965392	Spray wand tube assembly with nozzle	1
54	965400	Spray wand assembly complete	1
55	837344	Calibrated measuring cup	1
56	838169	Repair kit	1
57	147272	Diaphragm Installation Tool	1

# Illustrated Parts List (SP300 Begining Serial Number 913171J2)

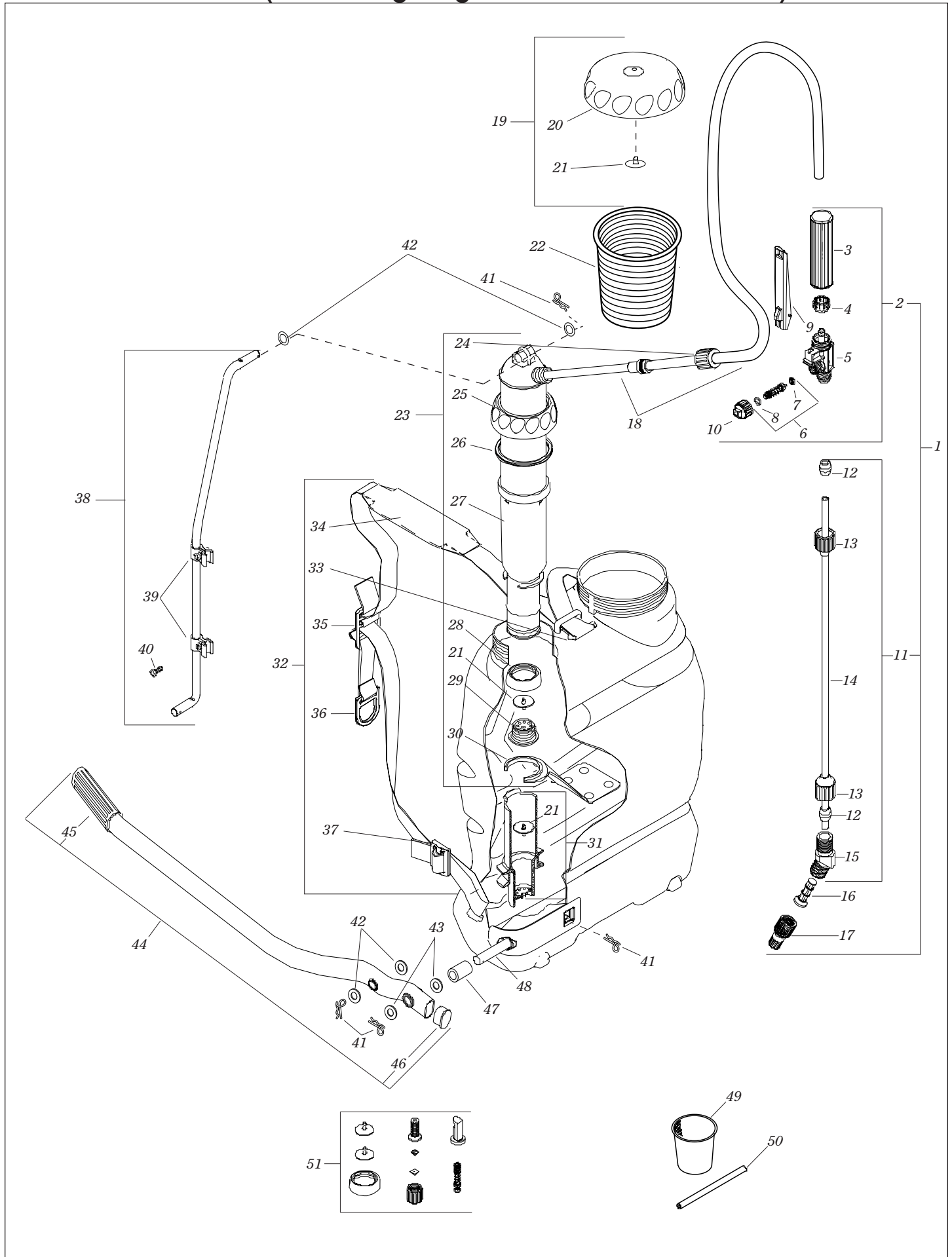

## Illustrated Parts List (SP300 Begining Serial Number 913171J2)

No.	Part Number	ItemDescription	Qty.
1	568774	Spray wand assembly	1
2	568782	Trigger valve assembly	1
3	909192	Trigger valve handle	1
4	920470	Hose ferrule	1
5	909283	Trigger valve body	1
6	105239	Trigger valve needle assembly	2
7	300731	Lower seal	1
8	300764	Upper seal	1
9	568972	Trigger	1
10	996058	Trigger Valve cap	1
11	568873	Wand tube/elbow assembly	1
12	909309	Cone packing	2
13	915744	Cone nut	2
14	336263	Spray tube	1
15	635276	Elbow	1
16	730366	Nozzle filter (40 mesh)	2
17	015024	Adjustable cone nozzle assembly	1
18	250928	Hose/Dip tube assembly	1
19	381202	Lid assembly	1
20	381194	Lid	1
21a	964270	Diaphragm valve Viton®	1
21b	560573	Diaphragm valve Nitrilic (optional)	1
22	942920	Strainer	1
23	965202	Chamber assembly	1
21a	964270	Diaphragm valve Viton®	1
21b	560573	Diaphragm valve Nitrilic (optional)	1
24	942193	Screw cap S-20	1
25	965335	Packing ring nut	1
26	965327	Packing ring Viton®	1
27	965319	Chamber body	1
28a	568535	Piston cup Viton®	1
28b	214585	Piston cup Santoprene® (optional)	1
29	214577	Piston cup fastener	1
30	214619	Agitator	1
31	965228	Cylinder assembly	1
21a	964270	Diaphragm valve Viton®	1
21b	560573	Diaphragm valve Nitrilic (optional)	1
32	965418	Strap assembly	1
33	965368	Shoulder strap lock	1
34	965426	Upper strap w/pad	1
35	120691	Shoulder strap buckle	2
36	965194	Lower strap assembly	2
37	502757	Lower strap buckle	2
38	965244	Pump lever connecting rod assembly	1
39	838003	Spray wand holding clip assy	1
40	825497	Screw, 3.5 x 16 mm	2
41	147256	Retaining clip	4
42	609438	Flat washer	4
43	965251	Flat washer	2
44	147264	Pump lever assembly	1
45	147231	Handgrip	1
46	147280	Plug	1
47	147223	Bushing	1
48	285593	Pump lever shaft	1
49	963959	Calibrated measuring cup	1
50	147272	Diaphragm tool	1
51	251074	Repair and nozzle kit	1

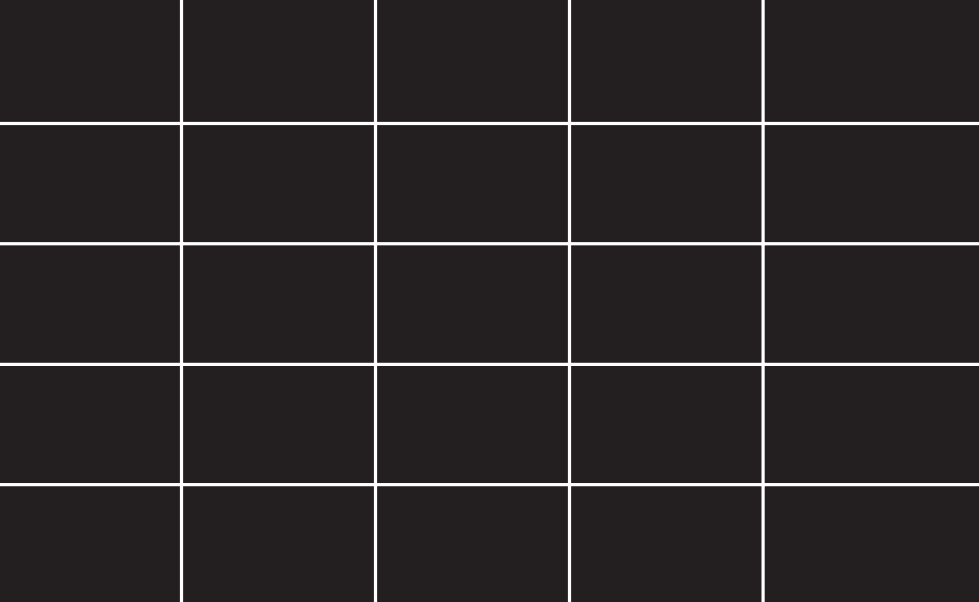

# shindaiwa®

Shindaiwa Inc.

11975 S.W. Herman Road

Tualatin, Oregon 97062

Telephone: 503 692-3070

Fax: 503 692-6696

[www.shindaiwa.com](http://www.shindaiwa.com)

©2002 Shindaiwa, Inc.

Part Number 80709

Revision 6/02

Shindaiwa is a registered trademark  
of Shindaiwa, Inc.

Specifications subject to change without notice.

Printed in Brazil

## Free Manuals Download Website

<http://myh66.com>

<http://usermanuals.us>

<http://www.somanuals.com>

<http://www.4manuals.cc>

<http://www.manual-lib.com>

<http://www.404manual.com>

<http://www.luxmanual.com>

<http://aubethermostatmanual.com>

Golf course search by state

<http://golfingnear.com>

Email search by domain

<http://emailbydomain.com>

Auto manuals search

<http://auto.somanuals.com>

TV manuals search

<http://tv.somanuals.com>