

# shindaiwa

Shindaiwa Inc.  
P.O. Box 2810  
Tualatin, Oregon 97062  
Telephone: 503 692-3070  
FAX: 503 692-6696  
www.shindaiwa.com

Shindaiwa Kogyo Co., Ltd.  
Head Office: 6-2-11 Ozuka  
Nishi, Asaminami-ku  
Hiroshima, 731-3167, Japan  
Telephone: 81-82-849-2220  
FAX: 81-82-849-2481

©2002 Shindaiwa, Inc.  
Part Number 63888-94010  
Printed in Japan  
Rev. 2/02

Specifications subject to change without notice.



## SHINDAIWA OWNER'S/ OPERATOR'S MANUAL

### P231 POLE PRUNER



#### **WARNING!**

Minimize the risk of injury to yourself and others! Read this manual and familiarize yourself with the contents. Always wear eye and hearing protection when operating this unit.

# shindaiwa

Part Number 63888-94010  
Rev. 2/02

## Introduction

The Shindaiwa P231 Pole Pruner is designed and built to deliver superior performance and reliability without compromise to quality, comfort, safety or durability.

Shindaiwa's high-performance engines represent the leading edge of 2-cycle engine technology, delivering exceptionally high power with remarkably low displacement and weight. As an owner/operator, you'll soon discover for yourself why Shindaiwa is simply in a class by itself!

### IMPORTANT!

The information contained in these instructions describes units available at the time of publication. While every attempt has been made to provide the latest information about your Shindaiwa product, there may be some differences between your P231 and what is described here. Shindaiwa Inc. reserves the right to make changes to products without prior notice and without obligation to make alterations to units previously manufactured.

The procedures described in this manual are intended to help you get the most from your unit as well as to protect you and others from harm. These procedures are guidelines for safe operation under most conditions, and are not intended to replace any safety rules and/or laws that may be in force in your area.

If you have questions regarding your power tool, or if you do not understand something in this manual, your Shindaiwa dealer will be glad to assist you.

You may also contact Shindaiwa, Inc. at the address printed on the back of this Manual.

## Contents

	PAGE
Introduction .....	2
Attention Statements .....	3
Safety Precautions .....	3
Operating the Pruner .....	5
Safety Equipment and Labels .....	6
Operating Precautions .....	7
Specifications .....	9
Product Description .....	10
Assembly .....	11
Installing Bar and Chain .....	15
Adjusting the Chain .....	16
Filling the Chain Oiler .....	17
Engine Fuel .....	18
Starting the Engine .....	19
Stopping the Engine .....	21
Adjusting Engine Idle .....	21
Maintenance .....	22
Long Term Storage .....	27
Chain Sharpening .....	28
Troubleshooting Guide .....	30
Emission System Warranty .....	34

## Owners Warranty Responsibilities

As the small off-road engine owner, you are responsible for the performance of the required maintenance listed in this owners manual. Shindaiwa Kogyo Co., Ltd. recommends that you retain all receipts covering maintenance on your small off-road engine, but Shindaiwa Kogyo Co., Ltd. cannot deny warranty solely for the lack of receipts or for your failure to ensure the performance of all scheduled maintenance.

As the small off-road engine owner, you should be aware, however, that Shindaiwa Kogyo Co., Ltd. may deny you warranty coverage if your small off-road engine or a part has failed due to abuse, neglect, improper maintenance, or unapproved modifications.

You are responsible for presenting your small off-road engine to an authorized Shindaiwa Dealer as soon as a problem exists. The warranty repairs should be completed in a reasonable amount of time, not to exceed 30 days.

If you have any questions regarding your warranty rights and responsibilities, you should contact a Shindaiwa customer service representative at (503) 692-3070 or your local Shindaiwa Dealer.

## Consequential Damages

In the event that other component parts of this product are damaged by the failure of a warranted part, Shindaiwa Kogyo Co., Ltd. will repair or replace such component parts at no charge to you.

## What is Not Covered

- Failures caused by abuse, neglect, or improper maintenance procedures.
- Failures caused by the use of modified or non-approved parts or attachments.

## This Warranty is Administered by:

Shindaiwa Inc.  
11975 S.W. Herman Rd.  
Tualatin, OR 97062  
(503) 692-3070

## Emission System Warranty Statement

### Your Warranty Rights and Obligations

The California Air Resources Board, the U.S. Environmental Protection Agency and Shindaiwa Kogyo Co., Ltd. are pleased to explain the emission control system warranty on your new small off-road (non-road) engine.

In California, new small off-road engines must be designed, built, and equipped to meet the State's stringent anti-smog standards. In other states, new 1997 and later non-road engines must meet the Federal EPA's stringent anti-smog standards. Shindaiwa Kogyo Co., Ltd. must warrant the emission control system on your small off-road engine for the periods of time listed below, provided there has been no abuse, neglect, or improper maintenance of your small off-road engine.

Your engine emission control system includes parts such as the carburetor, the ignition system and, if equipped, the catalytic converter. These components are specifically listed below.

Where a warrantable condition exists, Shindaiwa Kogyo Co., Ltd. will repair your small off-road engine at no cost to you including diagnosis, parts, and labor.

### Manufacturer's Warranty Coverage

When sold within the U.S., this engine's emission control system is warranted for a period of two (2) years from the date this product is first delivered to the original retail purchaser.

During the warranty period, Shindaiwa Kogyo Co., Ltd. will, at their option, repair or replace any defective emission-related component on this engine. During the original Warranty Period, these Warranty Rights are automatically transferable to subsequent owners of this product.

### What is Covered by this Warranty

1. Carburetor Internal Components
  - Throttle Valve, Needle, Jet, Metering Diaphragm
2. Ignition System Components
  - Ignition Coil
  - Flywheel Rotor
3. Catalytic Converter (if originally equipped)

The emission control system for your particular Shindaiwa engine may also include certain related hoses and connectors.

## Attention Statements

Throughout this manual are special attention statements.



### DANGER!

A statement preceded by the triangular attention symbol and the word "DANGER" contains information that should be acted upon to prevent serious injury or death.



### WARNING!

A statement preceded by the triangular attention symbol and the word "WARNING" contains information that should be acted upon to prevent serious bodily injury.

### CAUTION!

A statement preceded by the word "CAUTION" contains information that should be acted upon to avoid damage to the unit.

### IMPORTANT!

A statement preceded by the word "IMPORTANT" is one that possesses special significance.

### NOTE:

A statement preceded by the word "NOTE" contains information that is handy to know and may make your job easier.

## Safety Precautions



### WARNING!



### THE PRUNER IS NOT INSULATED AGAINST ELECTRICAL SHOCK!

Approaching or contacting electrical line with the pruner could cause death or serious injury. Keep the pruner at least 33 feet (10 meters) away from electrical lines or branches that contact electrical lines.



### WARNING!

The engine exhaust from this product contains chemicals known to the State of California to cause cancer, birth defects or other reproductive harm.

A pole pruner operates at very high speeds and has the potential to do serious damage if misused, abused or mishandled. To reduce the risk of injury, you must maintain control at all times, and observe all safety precautions during operation. **Never permit a person without training or instruction to operate this pruner!**



Read and follow this operators manual. Failure to do so could result in serious injury.



Always wear a hard hat to reduce the risk of head injuries during operation of this unit. Wear eye and hearing protection at all times during the operation of this unit.



Wear nonslip heavy-duty work gloves to improve your grip on the pole pruner handle. Wear sturdy footwear with nonslip soles to provide good footing. Steel-toed safety boots are recommended. Wear snug-fitting clothes that also permit freedom of movement.



Keep bystanders at least 50 feet (15 meters) away from the operating pruner to reduce the risk of being struck by falling objects or thrown debris.



Never operate the pruner at an angle greater than 60° in order to reduce the risk of being struck by falling objects during operation.



Never operate power equipment of any kind if you are tired or if you are under the influence of alcohol, drugs, medication, or any other substance that could affect your ability or judgement.

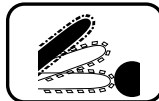

Beware of kickback! Kickback can occur whenever the tip of the guide bar touches an object while the saw is operating. Kickback may force the bar up and back toward the operator!

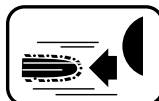

Beware of pinching. Pinching the saw along the tip of the guide bar may force the bar back rapidly toward the operator. Pinching can occur whenever wood closes in around the moving chain.

## Troubleshooting Guide (continued)

### ADDITIONAL PROBLEMS

Symptom	Possible Cause	Remedy
Excessive vibration.	Warped or damaged attachment.	Inspect and replace attachment as required.
	Loose gearcase.	Tighten gearcase securely.
	Bent main shaft/worn or damaged bushings.	Inspect and replace as necessary.
Cutter will not rotate.	Shaft not installed in powerhead or gearcase.	Inspect and reinstall as required.
	Broken shaft.	Consult with an authorized servicing dealer.
	Damaged gearcase.	Consult with an authorized servicing dealer.

## Kickback and Pinching Safety Precautions



### WARNING!

Both kickback and pinching may cause you to lose control of the pole pruner which could result in serious personal injury. **Do not rely exclusively on the safety device built into the pruner!** You must take several steps to keep your jobs free from accident or injury:

1. Understand kickback and pinching! You can reduce or eliminate the element of surprise. Sudden surprise contributes to accidents.
2. Keep a firm grip on the pole pruner with both hands whenever the engine is running. A firm grip will help you reduce the effects of kickback and pinching as well as maintaining control of the unit.
3. Make sure the area in which you are cutting is free from obstructions. Do not let the nose of the guide bar contact a log, branch, or any other obstructions which could be hit while you operate the pole pruner.
4. Cut at high engine speeds.
5. Follow the manufacturer's instructions for sharpening and maintaining the chain.
6. Use only the replacement bar and chain or equivalent as specified by the manufacturer.

## Troubleshooting Guide (continued)

### ADDITIONAL PROBLEMS

Symptom	Possible Cause	Remedy
Poor acceleration.	Clogged air cleaner element.	Clean the air cleaner element.
	Clogged fuel filter.	Replace the fuel filter.
	Carburetor mixture too lean.	Consult with an authorized servicing dealer.
	Idle speed set too low.	Adjust: 2,750 ( $\pm$ 250) rpm ( $\text{min}^{-1}$ )
Engine stops abruptly.	Switch turned off.	Reset the switch and re-start.
	Fuel tank empty.	Refuel.
	Clogged fuel filter.	Replace filter.
	Water in the fuel.	Drain and refill with fresh, clean unleaded gasoline with a pump octane of 87 or higher mixed with a 2-cycle air cooled mixing oil that meets or exceeds ISO-L-EGD and/or JASO FC classified oils at 50:1 gasoline/oil ratio.
	Shorted spark plug or loose terminal.	Clean and replace spark plug, tighten the terminal.
	Ignition failure.	Consult with an authorized servicing dealer.
	Piston seizure.	Consult with an authorized servicing dealer.
Engine difficult to shut off.	Ground (stop) wire is disconnected, or switch is defective.	Test and replace as required.
	Overheating due to incorrect spark plug.	Replace the spark plug with a Champion CJ8 or equivalent spark plug of the correct heat range. Adjust the spark plug electrode gap to 0.024-inch (0.6 mm).
	Overheated engine.	Idle engine until cool. Refer to page 20 (overheated engine).
Cutting attachment moves at engine idle.	Engine idle too high.	Set idle: 2,750 ( $\pm$ 250) rpm ( $\text{min}^{-1}$ )
	Broken clutch spring or worn clutch spring boss.	Replace spring/shoes as required, check idle speed.
	Loose attachment holder.	Inspect and re-tighten holder securely.

## Operating the Pruner

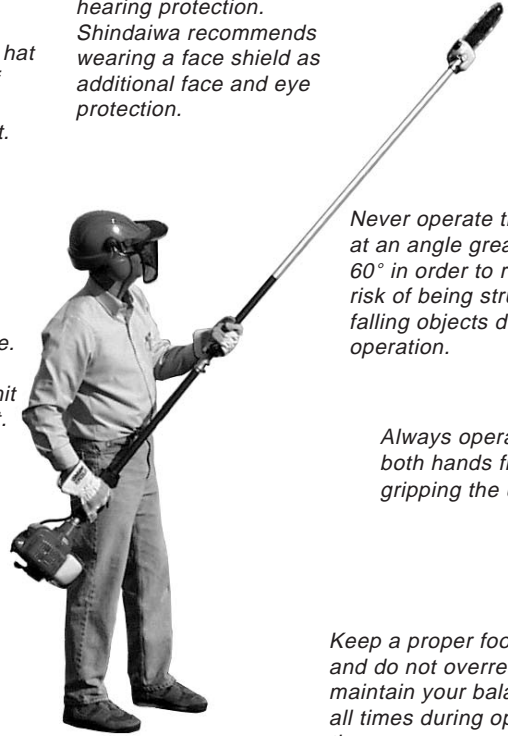

Always wear eye and hearing protection. Shindaiwa recommends wearing a face shield as additional face and eye protection.

Always wear a hard hat to reduce the risk of head injuries during operation of this unit.

Never operate the pruner at an angle greater than 60° in order to reduce the risk of being struck by falling objects during operation.

Always operate with both hands firmly gripping the unit.

Keep a proper footing and do not overreach—maintain your balance at all times during operation.

Wear nonslip heavy-duty work gloves to improve your grip on the pole pruner handle. Wear snug-fitting clothes that also permit freedom of movement. NEVER wear shorts!

Wear sturdy footwear with nonslip soles to provide good footing. Steel-toed safety boots are recommended. Never operate unit bare-footed!

Keep bystanders at least 50 feet (15 meters) away from the operating pruner to reduce the risk of being struck by falling objects or thrown debris.

**Figure 1**

## Safety Equipment and Labels

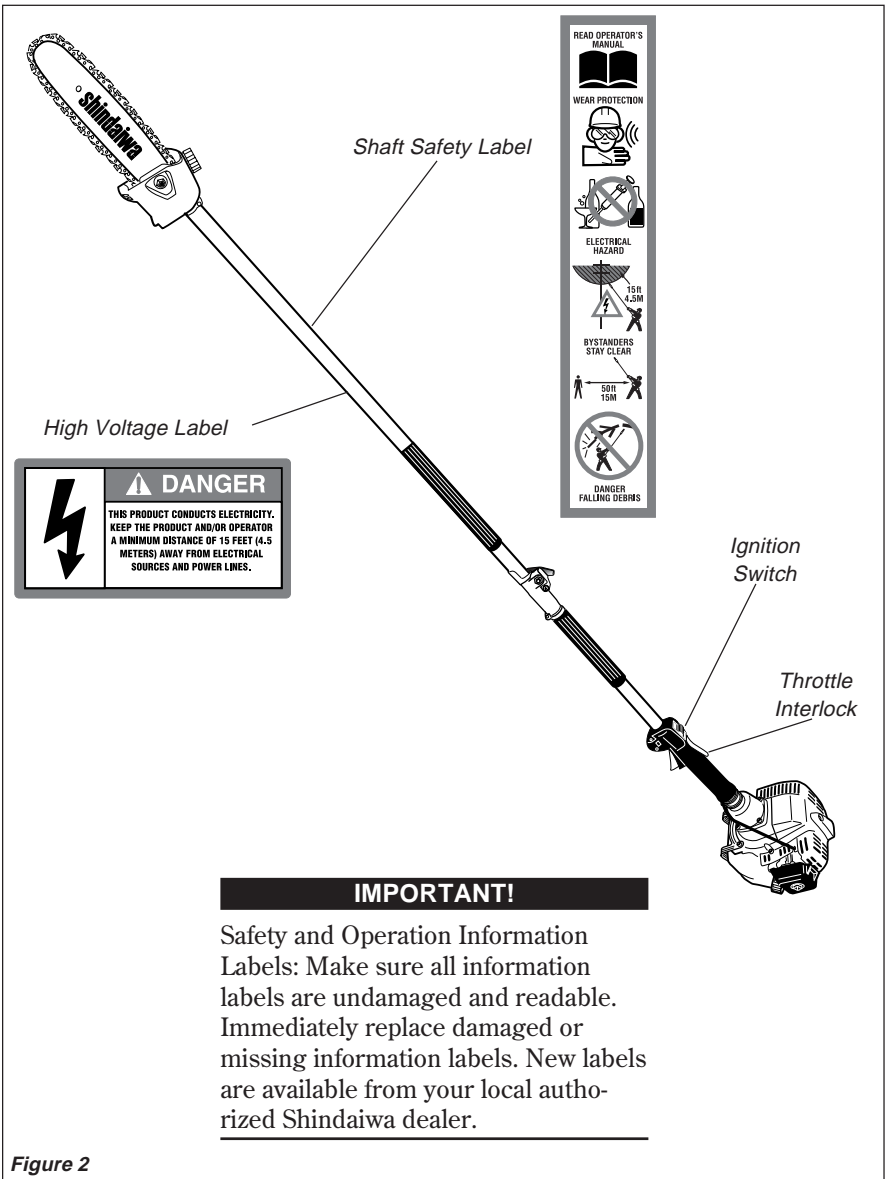

Figure 2

## Troubleshooting Guide (continued)

LOW POWER OUTPUT		
What To Check	Possible Cause	Remedy
Is the engine overheating?	Operator is overworking the machine.	Shorten trimmer line. Cut at a slower rate.
	Carburetor mixture is too lean.	Consult with an authorized servicing dealer.
	Improper fuel ratio.	Refill with fresh, clean unleaded gasoline with a pump octane of 87 or higher mixed with a 2-cycle air cooled mixing oil that meets or exceeds ISO-L-EGD and/or JASO FC classified oils at 50:1 gasoline/oil ratio.
	Fan, fan cover, cylinder fins dirty or damaged.	Clean, repair or replace as necessary.
	Carbon deposits on the piston or in the muffler.	Consult with an authorized servicing dealer.
	Engine is rough at all speeds. May also have black smoke and/or unburned fuel at the exhaust.	Clogged air cleaner element.
Engine is rough at all speeds. May also have black smoke and/or unburned fuel at the exhaust.	Loose or damaged spark plug.	Tighten or replace. Replace the spark plug with a Champion CJ8 or equivalent spark plug of the correct heat range. Adjust the spark plug electrode gap to 0.024-inch (0.6 mm).
	Air leakage or clogged fuel line.	Repair or replace fuel filter and/or fuel line.
	Water in the fuel.	Refill with fresh, clean unleaded gasoline with a pump octane of 87 or higher mixed with a 2-cycle air cooled mixing oil that meets or exceeds ISO-L-EGD and/or JASO FC classified oils at 50:1 gasoline/oil ratio.
	Piston seizure.	Consult with an authorized servicing dealer.
	Faulty carburetor and/or diaphragm.	Consult with an authorized servicing dealer.
	Engine is knocking.	Overheating condition.
Improper fuel.		Check fuel octane rating; check for presence of alcohol in the fuel (pg. 18). Refuel as necessary.
Carbon deposits in the combustion chamber.		Consult with an authorized servicing dealer.

# Troubleshooting Guide

## ENGINE DOES NOT START

What To Check	Possible Cause	Remedy
Does the engine crank? <b>YES</b> ↓	<b>NO</b> → Faulty recoil starter. Fluid in the crankcase. Internal damage.	Consult with an authorized servicing dealer.
Good compression? <b>YES</b> ↓	<b>NO</b> → Loose spark plug. Excess wear on cylinder, piston, rings.	Tighten and re-test. Consult with an authorized servicing dealer.
Does the tank contain fresh fuel of the proper grade? <b>YES</b> ↓	<b>NO</b> → Fuel incorrect, stale, or contaminated; mixture incorrect.	Refill with fresh, clean unleaded gasoline with a pump octane of 87 or higher mixed with a 2-cycle air cooled mixing oil that meets or exceeds ISO-L-EGD and/or JASO FC classified oils at 50:1 gasoline/oil ratio
Is fuel visible and moving in the return line when priming? <b>YES</b> ↓	<b>NO</b> → Check for clogged fuel filter and/or vent.	Clean as required; restart.
Is there spark at the spark plug wire terminal? <b>YES</b> ↓	<b>NO</b> → The ignition switch is in "O" (OFF) position. Shorted ignition ground. Faulty ignition unit.	Move switch to "I" (ON) position and re-start. Consult with an authorized servicing dealer.
Check the spark plug.	→ If the plug is wet, excess fuel may be in the cylinder.	Crank the engine with the plug removed, reinstall the spark plug, and re-start.
	The plug is fouled or improperly gapped.	Clean and re-gap the spark plug to 0.024 inch (0.6 mm). Re-start.
	The plug is damaged internally or of the wrong size.	Replace the spark plug with a Champion CJ8 or equivalent spark plug of the correct heat range. Adjust the spark plug electrode gap to 0.024-inch (0.6 mm).

# Operating Precautions



## WARNING! Use Good Judgement

- Make sure the chain and sprocket are correctly adjusted before operating the pruner (see page 15 for adjustment procedures). **Never attempt chain adjustment with the engine running!**
- Always make sure the cutting attachment is properly installed and firmly tightened before operation.
- Never use a cracked or warped guide bar: replace it with a serviceable guide bar and make sure it fits properly.
- If a saw blade should bind fast in a cut, shut off the engine immediately. Push the branch or tree to ease the bind and free the blade.
- Make sure there are no missing or loose fasteners, and that the ignition switch and throttle controls are working properly.
- Before starting the engine, make sure the saw chain is not contacting anything.
- Make sure there is always good ventilation when operating the pruner. Fumes from engine exhaust can cause serious injury or death. **Never run the engine indoors!**
- Do not operate the pole pruner with the muffler removed.
- When cutting a limb that is under tension, be alert for springback so that you will not be struck by the moving limb.
- Always stop the engine immediately and check for damage if you strike a foreign object or if the unit becomes tangled. Do not operate with broken or damaged equipment.
- Stop the unit immediately if it suddenly begins to vibrate or shake. Inspect for broken, missing or improperly installed parts or attachments.
- Never transport the pruner nor set it down with the engine running. An engine that's running could be accidentally accelerated causing the chain to rotate.



## WARNING! Minimize the Risk of Fire

- **NEVER** smoke or light fires near the unit.
- **ALWAYS** stop the engine and allow it to cool before refueling. Avoid overfilling and wipe off any fuel that may have spilled.
- **ALWAYS** move the unit to a place well away from a fuel storage area or other readily flammable materials before starting the engine.
- **ALWAYS** inspect the unit for fuel leaks before each use. During each refill, check that no fuel leaks from around the fuel cap and/or fuel tank. If fuel leaks are evident, stop using the unit immediately. Fuel leaks must be repaired before using the unit.
- **NEVER** place flammable material close to the engine muffler.
- **NEVER** run the engine without the spark arrester screen in place.

Operating Precautions

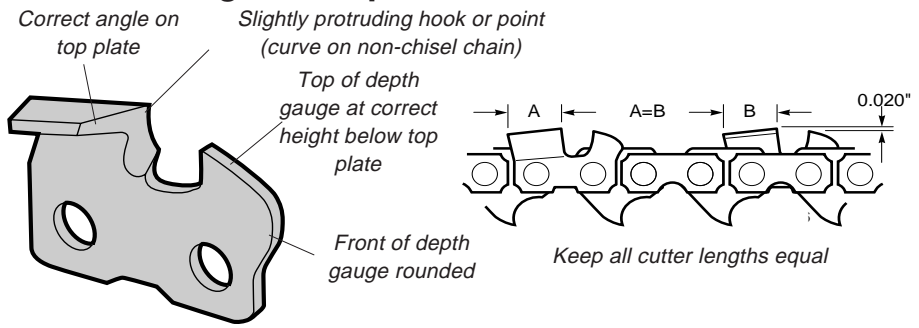

Figure 3

**CAUTION!**

- Always maintain the P231 pole pruner according to the this owner's manual and follow the recommended scheduled maintenance.
- Never modify or disable any of the pole pruner's safety devices.
- Always use genuine Shindaiwa parts and accessories when repairing or maintaining this unit.
- Do not make unauthorized modifications or substitutions to the guide bar or chain.
- Never allow the engine to run at high RPM without a load. Doing so could damage the engine.
- When transporting the pruner in a vehicle, tie it down securely to prevent damage and fuel spillage.
- Always clear your work area of trash or hidden debris to help ensure good footing.
- Keep the saw chain sharp and properly adjusted.
- Keep the pruner as clean as possible. Keep it free of loose vegetation, mud, etc.
- Make sure the scabbard is in place when transporting the pruner.
- When carrying by hand, the chain should be pointing backward. See Figure 3.

Correct Filing Technique



Filing Problems

<p><b>Top plate angle less than recommended</b></p> <p><b>Cause</b> File held at less than recommended angle.</p> <p><b>Result</b> Slow cutting. Requires extra effort to cut.</p> <p><b>Remedy</b> File cutters to recommended angle.</p>	<p><b>Top plate angle more than recommended</b></p> <p><b>Cause</b> File held at more than recommended angle.</p> <p><b>Result</b> Cutting angle is very sharp but will dull fast. Cutting action rough and erratic.</p> <p><b>Remedy</b> File cutters to recommended angle.</p>
<p><b>Hook in side plate cutting edge</b></p> <p><b>Cause</b> File held too low or the file was too small.</p> <p><b>Result</b> Rough cutting. Chain grabs. Cutters dull quickly or won't hold a cutting edge.</p> <p><b>Remedy</b> File cutters at recommended angle. Check file size.</p>	<p><b>Backslope on side plate cutting edge</b></p> <p><b>Cause</b> File held too high or the file was too large.</p> <p><b>Result</b> Cutters won't feed into wood. Slow cutting. Must force chain to cut. Causes excessive bottom wear.</p> <p><b>Remedy</b> File cutters at recommended angle. Check file size.</p>
<p><b>High depth gauge</b></p> <p><b>Cause</b> Depth gauge never filed.</p> <p><b>Result</b> Slow cutting. Must force chain to cut. Will cause excessive wear on the cutter heel.</p> <p><b>Remedy</b> Lower gauges to recommended setting.</p>	<p><b>Low depth gauge</b></p> <p><b>Cause</b> Wrong gauge setting or no gauge used.</p> <p><b>Result</b> Rough cutting. Chain grabs. Saw won't pull chain through wood. Excessive wear on the cutter heel.</p> <p><b>Remedy</b> If depth gauges are too low, the chain is no longer serviceable.</p>



## Sharpening the Chain

When the cutting edges of the blade become dull, they can be re-sharpened with a few strokes of a file.

In order to keep the blade in balance, all cutting edges must be sharpened equally.

In addition, inspect the chain for correct adjustment (more frequently with a new chain). The chain should feel snug but still pull freely. See Figure 36. Refer to page 16 for adjustment procedures.

### Sharpening Instructions (Fig.37)

#### IMPORTANT!

File all cutters to the same angle and depth! Unequal filing may cause the saw to vibrate or cut erratically!

1. Using a 4.5 mm round file, sharpen all cutters to a 30° angle. Make sure that one fifth (20%) of the file's diameter is always held above the cutter's top plate.

#### NOTE:

For consistent filing angles, use a filing guide such as Oregon® p/n 31692 or equivalent.

2. After all cutters are sharpened, use a depth gauge joiner (Oregon® p/n 106738 or equivalent) to measure the height of each depth gauge.
3. As required, lower the depth gauges to a height of 0.020 inch. Use a flat file; (Oregon® p/n 12211 or equivalent).
4. After all depth gauges have been adjusted, use a flat file to round each depth gauge leading edge to its original curvature and angle.

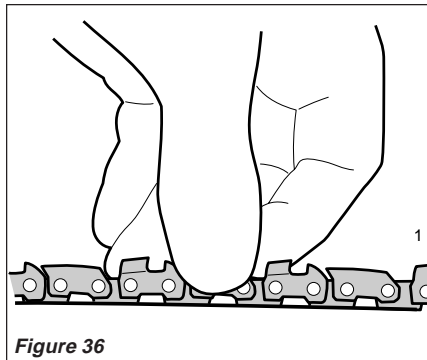

Figure 36

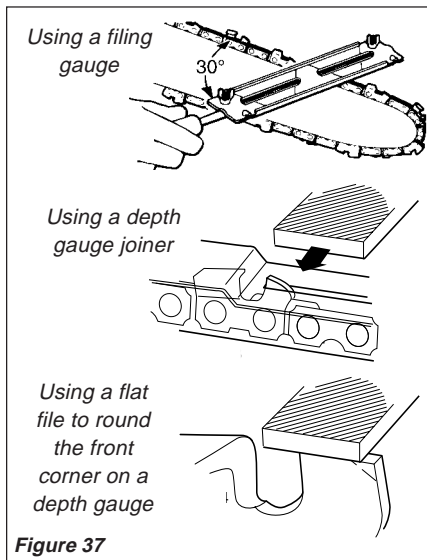
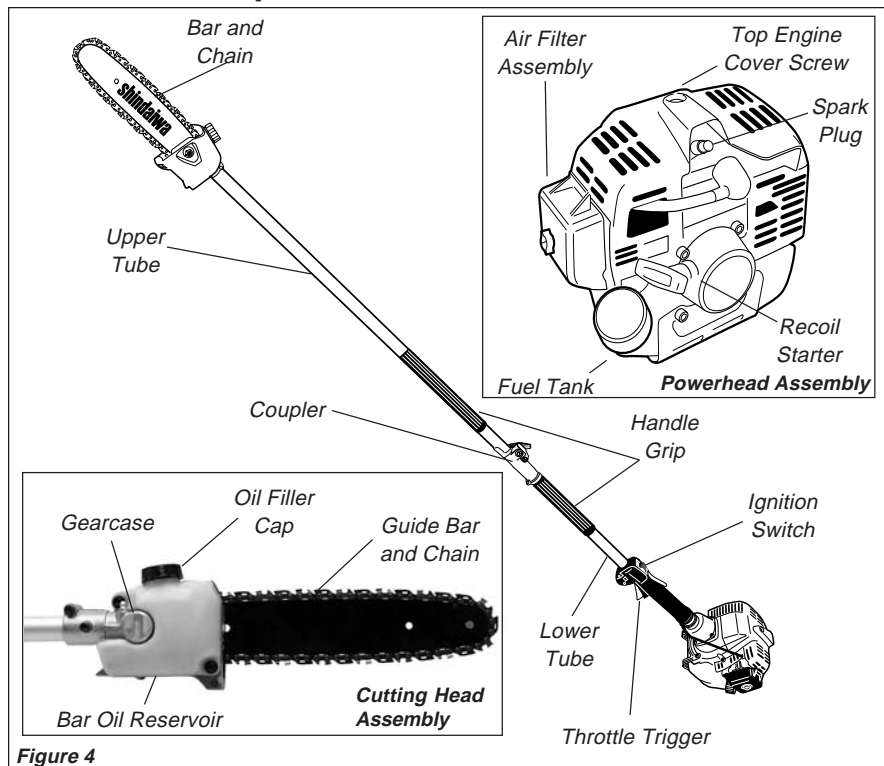

Figure 37

## P231 Specifications

Dry Weight .....	6.1 kg/13.4 lb.	Transmission Type .....	Automatic, centrifugal clutch with bevel gear
Length w/10" bar assembly .....	2804 mm/110.4 in.	Chain Guide Bar .....	3/8" pitch, .043" gauge, 10-inch Micro Lite™
Engine Type .....	2-cycle, air-cooled, vertical-cylinder	Chain Type .....	3/8" pitch Micro Lite™, .043" gauge
Bore x Stroke ...	32 x 28 mm/1.3 x 1.1 in.	Sprockets .....	3/8-inch, fixed spur
Displacement .....	22.5 cc/1.4 cu. in.	Gearcase Ratio .....	1.06 : 1
Maximum Output .....	0.8kW/1.1 hp @ 7500 rpm (min <sup>-1</sup> )	Chain Speed .....	23.5 m (77 ft.)/sec. @ 10,000 rpm (min <sup>-1</sup> )
Fuel/oil ratio .....	50:1 with ISO-L-EGD or JASO FC class 2-cycle Mixing Oil <i>Shindaiwa ONE is a registered JASO FC classified oil and also meets or exceeds ISO-L-EGD performance requirements.</i>	Chain Lubrication .....	Automatic adjustable oiler
Fuel Tank Capacity ....	670 ml/22.7 oz.	Chain Lubricant ...	Shindaiwa Premium Bar and Chain Oil
Carburetor Type .....	Walbro WYL-122	Standard Equipment .....	Bar/chain scabbard, tool kit containing a spark plug wrench, 4 mm hex wrench and 8 mm x 10 mm spanner
Ignition .....	One-piece, electronic, transistor-controlled	Optional Equipment ....	Shoulder strap, loop handle
Spark Plug .....	Champion CJ8	Optional Bars .....	8-inch or 12-inch
Air Filter .....	Non-reversible flocked filter element	EPA Emission Compliance Period* .....	Category A
Muffler Type .....	2-Stage Catalyst	* The EPA emission compliance referred to on the emission compliance label located on the engine, indicates the number of operating hours for which the engine has been shown to meet Federal emission requirements. Category C = 50 hours (Moderate), B = 125 hours (Intermediate) and A = 300 hours (Extended).	
Starting Method .....	Recoil	Specifications are subject to change without notice.	
Cooling System .....	Forced air		
Stopping Method .....	Slide switch		

## Product Description



### Prior To Assembly

Using Figure 4 as a guide, familiarize yourself with the Shindaiwa P231 pole pruner and its various components. Understanding your unit helps ensure top performance, longer service life, and safer operation.

Before assembling, make sure you have all the components required for a complete unit:

- Powerhead assembly
- Lower tube assembly
- Upper tube/saw assembly, chain and guide bar
- Kit with this manual and tool kit for routine maintenance.
- Scabbard.

Carefully inspect all components for damage.

## Long Term Storage

Whenever the unit will not be used for 30 days or longer, use the following procedures to prepare it for storage:

- Clean external parts thoroughly and apply a light coating of oil to all metal surfaces.
- Drain all the fuel from the fuel tank.

### IMPORTANT!

All stored fuels should be stabilized with a fuel stabilizer such as STA-BIL™, if  oil with fuel stabilizer is not used.

To remove the remaining fuel from the fuel lines and carburetor and with the fuel drained from the fuel tank.

1. Prime the primer bulb until no more fuel is passing through.
2. Start and run the engine until stops running.
3. Repeat steps 1 and 2 until the engine will no longer start.

### CAUTION!

Gasoline stored in the carburetor for extended periods can cause hard starting, and could also lead to increased service and maintenance costs.

- Remove the spark plug and pour about 1/4 ounce of 2-cycle mixing oil into the cylinder through the spark plug hole. Slowly pull the recoil starter 2 or 3 times so oil will evenly coat the interior of the engine. Reinstall the spark plug.
- Before storing the unit, repair or replace any worn or damaged parts.
- Remove the air cleaner element from the carburetor and clean it thoroughly with soap and water. Let dry and reassemble the element.
- Store the unit in a clean, dust-free area.

### IMPORTANT!

The terms “left”, “left-hand”, and “LH”; “right”, “right-hand”, and “RH”; “front” and “rear” refer to directions as viewed by the operator during normal operation.



### WARNING!

Do not make unauthorized modifications or alterations to your pruner or its components.

## 135-hour Maintenance

Every 135 hours of operation, remove and clean the muffler.



### WARNING!

Never operate the unit with a damaged or missing muffler or spark arrester! Operating with missing or damaged exhaust components is a fire hazard and could also damage your hearing.

1. Remove the spark plug boot.
2. Loosen the two 4 mm engine cover screws (located at the top of the recoil housing).
3. Loosen the 5 mm engine top cover screw (the screw is captive) and lift the cover from the engine.
4. Remove the two 5 mm muffler screws. Remove the lower muffler screw, then lift the muffler assembly from the engine.

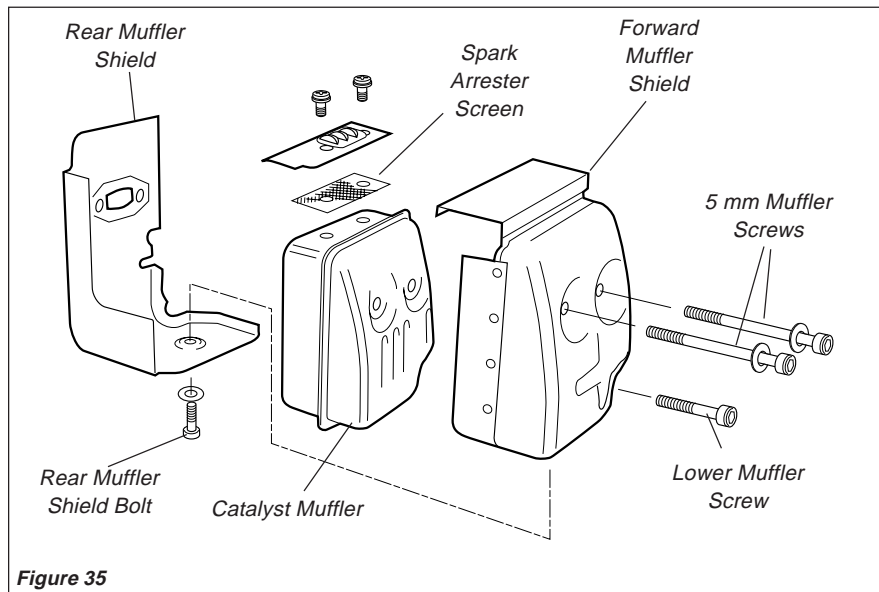

Figure 35

5. Remove the rear muffler shield bolt and, while noting the orientation of parts, separate the muffler shield.
6. Remove the spark arrester screen and clean with a stiff bristle brush.
7. Gently tap the muffler on a wood surface to dislodge any loose carbon.
8. Inspect the cylinder exhaust port for carbon buildup.

### IMPORTANT!

If you note excessive carbon buildup, consult your servicing dealer.

9. Reassemble the muffler in the reverse order of disassembly.

## Assembly Driveshaft/Powerhead

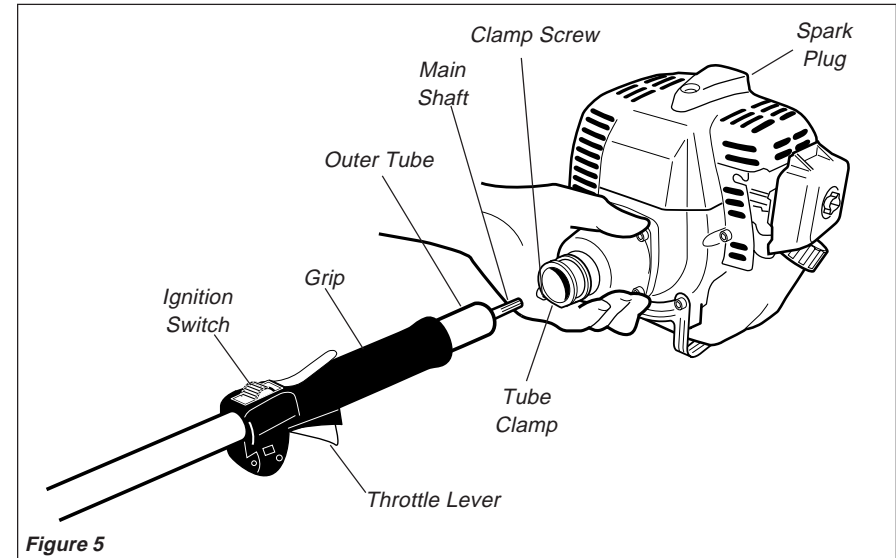

Figure 5

### Connect the Outer Tube to the Powerhead.

1. Place the powerhead on a clean, flat surface, spark plug facing up. See Figure 5.
2. Use the 4 mm hex wrench to loosen the tube clamp screw. Verify that the D-shaped shim washer is positioned as shown. See Figure 6.
3. Add some moly-type EP grease to splines at the end of the main shaft.
4. Slide the outer tube into the tube clamp until the tube bottoms. If installation is difficult, rotate the outer tube or gearcase shaft slightly until you feel the mainshaft splines engage with the powerhead. See Figure 5.
5. Position the outer tube so that the ignition switch is facing up and the throttle lever is facing down. See Figure 5.
6. Slide the outer tube into the powerhead until the throttle grip just contacts the tube clamp.
7. Tighten the clamp screw firmly.

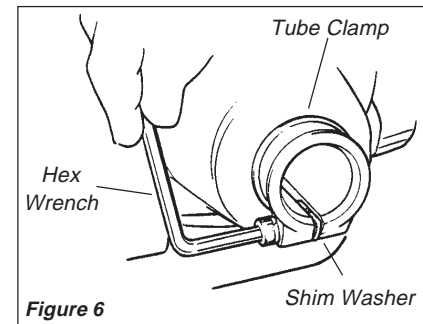

Figure 6

### CAUTION!

Do not remove the D-shaped shim washer! The shim washer prevents damage from overtightening the tube clamp screw.

### CAUTION!

Do not force the shaft tube into the powerhead! Excessive force can damage the shaft tube and mainshaft.

# Assembly

## Throttle Linkage and Ignition Leads

### Remove the Cylinder Cover.

1. Remove the spark plug boot.
2. Remove the two lower cylinder cover screws.
3. Loosen the top cylinder cover screw until the cover is free of the engine. (The top cylinder cover screw is captive). Lift the cylinder cover off of the engine. See Figure 7.

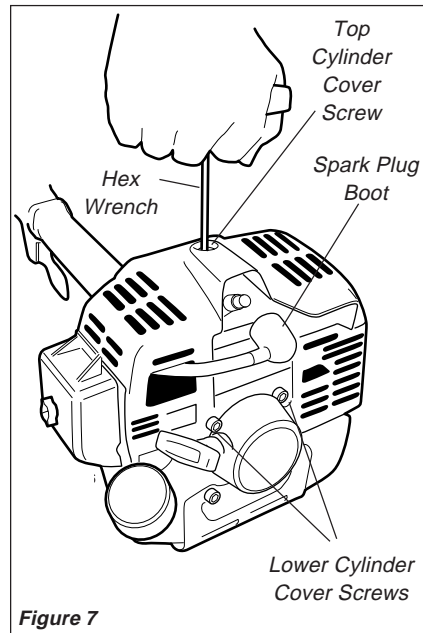

### Connect the Throttle Cable.

1. Loop the ribbed cable tube to the top left side of the engine.
2. Install the black wire between the two cable adjuster nuts as shown. See Figure 8.

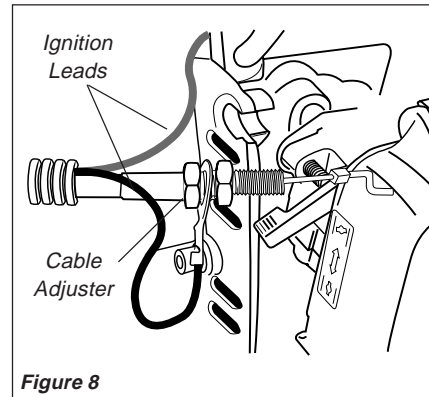

3. Connect the S-shaped end of the throttle cable to the throttle lever on top of the carburetor. See Figure 9.

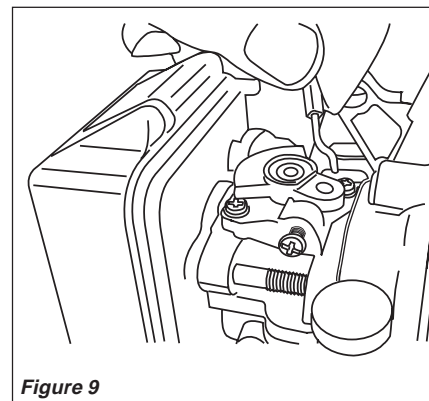

## 50-hour Maintenance

### Every 50 hours of operation

(more frequently in dusty or dirty conditions):

- Remove and clean the cylinder cover and clean dirt and debris from the cylinder cooling fins.
- Remove the sprocket cover and inspect the sprocket for excessive dirt, debris, or wear. Remove the guide bar and clean out the guide bar groove. If the sprocket is excessively worn, replace it with a new one. See Figure 32.

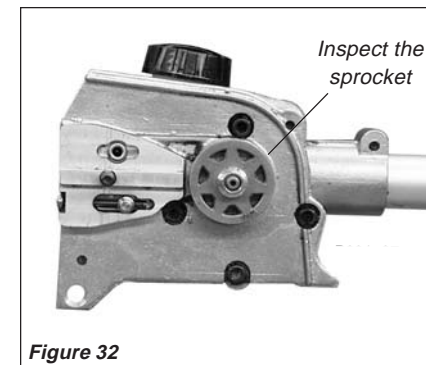

- **Lubricate the gearcase.** To perform this operation, first remove the gearcase from the upper outer tube as follows (Figure 33):

#### CAUTION!

Do not remove the D-shaped shim washer from the gearcase clamp! The shim washer prevents damage from overtightening the tube clamp screw.

- loosen the gearcase clamp bolt.
- remove the index bolt from the gearcase.
- slide the gearcase out of the tube.

Using a lever-type grease gun, pump lithium-base grease (about 10 grams) into the grease fitting until you see old grease being purged

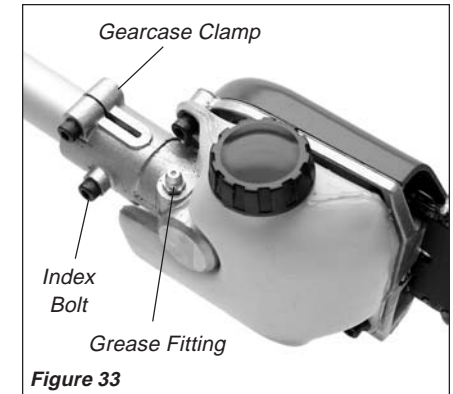

from the gearcase, this can be seen in the outer tube cavity at the input end of the gearcase. Clean up excess grease, then reassemble the gearcase onto the outer tube.

- Use a hooked wire to extract the fuel filter from inside the fuel tank (Figure 34). Inspect the fuel filter element for signs of contamination. Replace it with a new one if required. Before reinstalling the filter, inspect the fuel line. If you find damage or deterioration, remove the unit from service until it can be inspected by a Shindaiwa-trained service technician.

#### CAUTION!

Make sure you do not pierce the fuel line with the end of the hooked wire. The line is delicate and can be damaged easily.

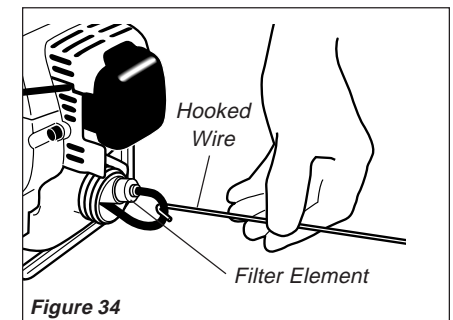

## 10-Hour Maintenance

### CAUTION!

Do not operate the unit if the air cleaner or element is damaged, or if the element is wet.

**Every 10 hours of operation,** (more frequently in dusty or dirty conditions):

Remove the air cleaner element from the air cleaner housing and clean it thoroughly with soap and water. Let it dry before reinstalling the element. See Figure 30.

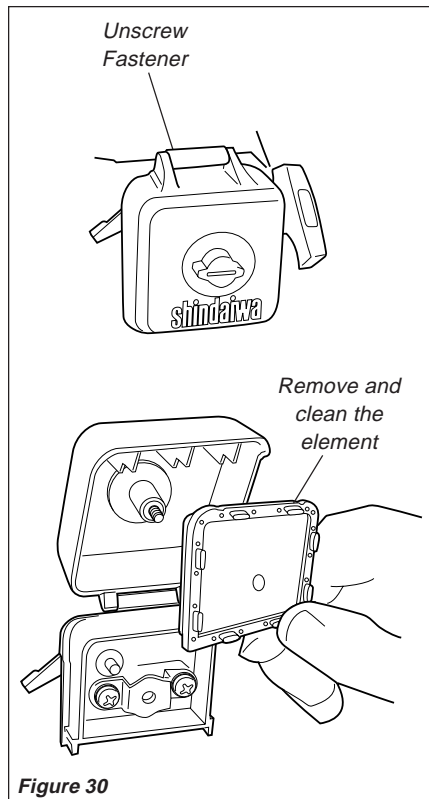

Figure 30

## 10/15-Hour Maintenance

### CAUTION!

Before removing the spark plug, clean the area around the plug to prevent dirt and debris from getting into the engine's internal parts.

**Every 10 to 15 hours of operation:**

Remove and clean the spark plug. See Figure 31. Adjust the spark plug electrode gap to 0.024-inch (0.6 mm). If the plug must be replaced, use only: Champion CJ8 or equivalent spark plug of the correct heat range.

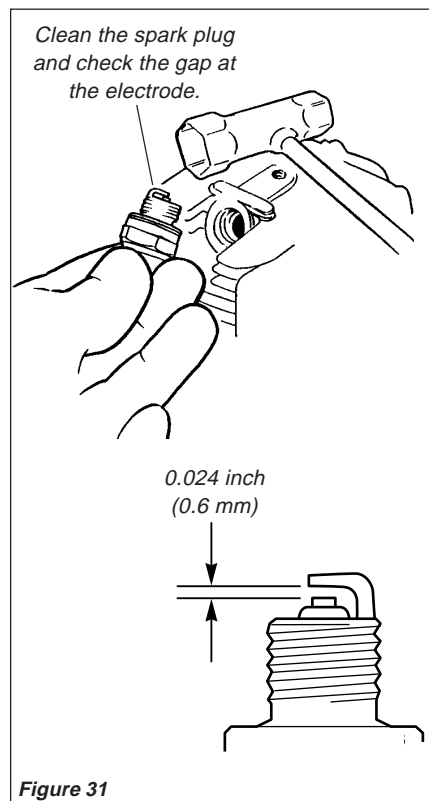

Figure 31

## Assembly

### Throttle Linkage and Ignition Leads

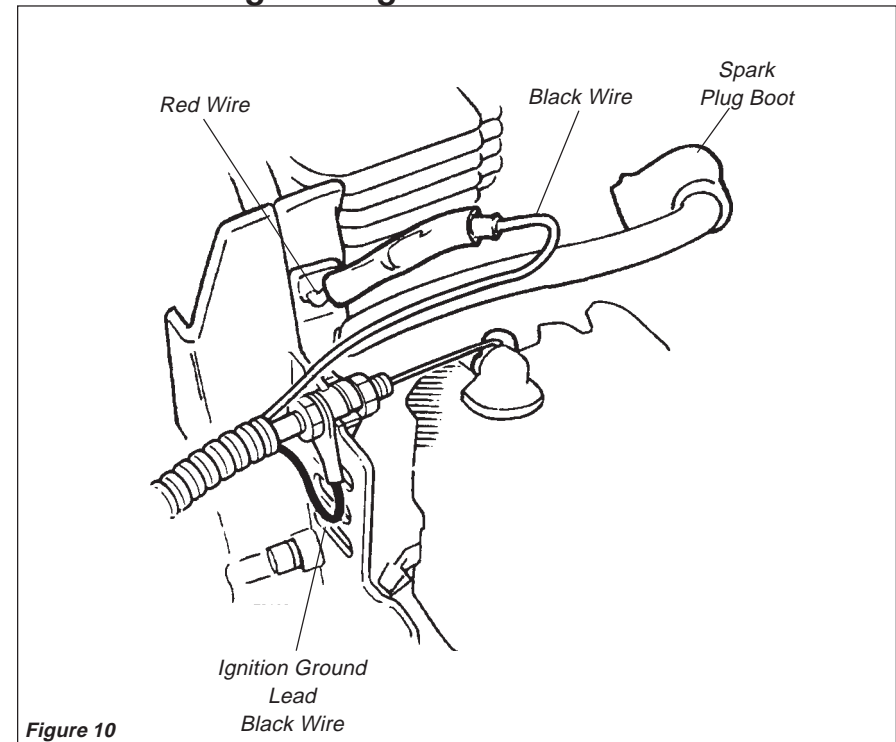

Figure 10

### Assemble and Adjust the Throttle Cable.

1. Insert the throttle cable housing into the notch on the fan cover, and clamp the black wire's connector between the fan cover and the cable outer adjuster nut. See Figure 10.
2. Tighten the two throttle cable adjuster nuts.
3. Using finger pressure only, connect the black switch wire from the cable tube to the red ignition wire on the powerhead. Wire routing must be as shown in the illustration with the black wire located over the spark plug wire. See Figure 10.
4. Reinstall the cylinder cover and tighten the three cover screws.
5. Reinstall the spark plug boot.

### IMPORTANT!

Adjust and tighten the cable nuts to allow approximately 1/4-inch freeplay at the throttle trigger.

### CAUTION!

Routing of wiring must not interfere with throttle operation.

## Assembling the Tube Sections

1. Place the powerhead/lower tube assembly and the upper tube assembly on a clean, flat surface so that both assemblies fit end to end. The powerhead/lower tube assembly should be facing up, and the lower tube assembly should be positioned with the locking hole in the tube end facing up.

### CAUTION!

Keep the open ends of the tubes clean and free of debris!

2. Slip off the protective covers from the ends of both tubes, and loosen the coupler screw knob.
3. Insert the upper tube assembly into the coupler, arrow on the upper tube decal facing up, until the line of the decal is flush with the end of the coupler. Rock the upper tube back and forth until you are sure the latch snaps in place by the coupler lock. See Figure 11.

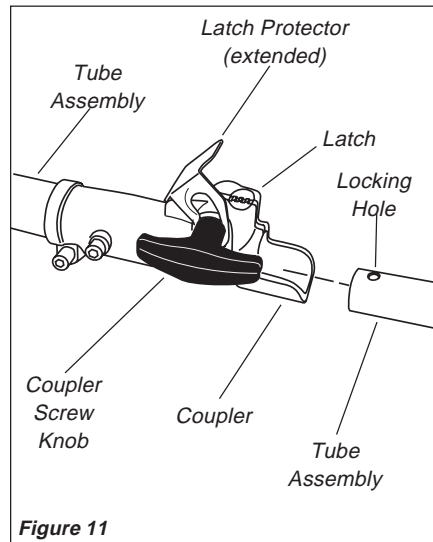

Figure 11

4. When the two tube halves are locked together, press down on the spring-loaded latch protector and tighten the coupler screw. See Figure 12.

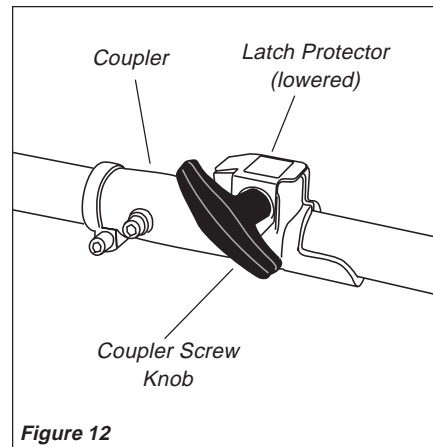

Figure 12

## Disassembling The Pole Sections

1. With the pole pruner on a clean, flat surface, loosen the coupler screw. The spring-loaded coupler protector should pop up.
2. Press down on the latch with your finger or thumb. See Figure 13. This releases the coupler lock.

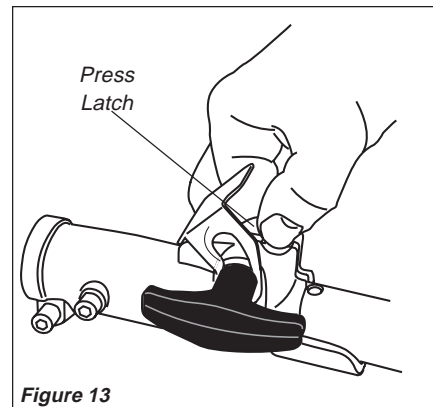

Figure 13

3. Pull the upper tube assembly out of the coupler.

## Muffler



### WARNING!

Operating the engine without a muffler or with a muffler that is damaged or improperly installed can increase engine noise sufficiently to cause hearing loss.

This unit must never be operated with a faulty or missing spark arrester or muffler. Make sure the muffler is well secured and in good condition. A worn or damaged muffler is a fire hazard and may also cause hearing loss.

## Spark Plug

Keep the spark plug and wire connections tight and clean.

## Daily Maintenance

Prior to each work day, perform the following:

- Remove all dirt and debris from the engine, check the cooling fins and air cleaner for clogging, and clean as necessary. See Figure 29.

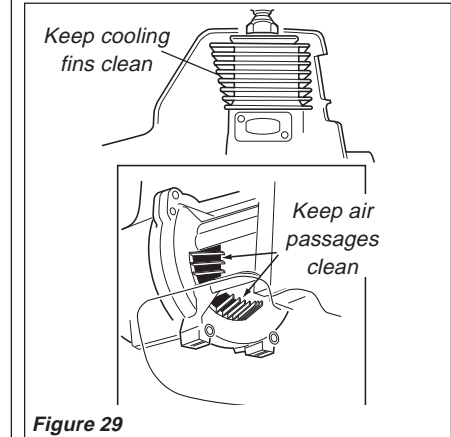

Figure 29

- Carefully remove any accumulations of dirt or debris from the muffler and fuel tank. Check cooling air intake area at base of crankcase. Remove all debris. Dirt build-up in these areas can lead to engine overheating, fire, or premature wear.



### WARNING!

Always wear gloves when working around the cutter assembly.

- Clean any debris or dirt from the cutting attachment. Check the bar and chain for damage or incorrect adjustment.
- Check for loose or missing screws or components. Make sure the cutter attachment is securely fastened.
- Check the entire unit for leaking fuel or grease.
- Make sure nuts, bolts, and screws (except carburetor idle speed adjusting screws) are tight.

## General Maintenance

### IMPORTANT!

MAINTENANCE, REPLACEMENT, OR REPAIR OF EMISSION CONTROL DEVICES AND SYSTEM MAY BE PERFORMED BY ANY REPAIR ESTABLISHMENT OR INDIVIDUAL. HOWEVER, WARRANTY REPAIRS MUST BE PERFORMED BY A DEALER OR SERVICE CENTER AUTHORIZED BY SHINDAIWA KOGYO, LTD. AND USE OF PARTS THAT ARE NOT EQUIVALENT IN PERFORMANCE AND DURABILITY TO AUTHORIZED PARTS MAY IMPAIR THE EFFECTIVENESS OF THE EMISSION CONTROL SYSTEM AND MAY HAVE A BEARING ON THE OUTCOME OF THE WARRANTY CLAIM.



### WARNING!

Before performing any maintenance, repair, or cleaning work on the unit, make sure the engine and cutting attachment are completely stopped. Disconnect the spark plug wire before performing service or maintenance work.



### WARNING!

Non-standard accessories, cutting attachment, or replacement parts may not operate properly with your unit and may cause damage and lead to personal injury.

### IMPORTANT!

Using non-standard replacement parts could invalidate your Shindaiwa warranty.

## Installing and Adjusting the Bar and Chain

### Installing The Chain



### WARNING!

Never attempt to install, replace, or adjust the chain with the engine running.



### WARNING!

The saw chain is very sharp. Wear gloves to protect your hands when handling.

### NOTE:

For longest chain life, let new or replacement chain loops soak in oil overnight before installation.

1. Using the small end of the plug wrench, remove the sprocket cover nut (turn counterclockwise to remove) and remove the sprocket cover. See Figure 14.

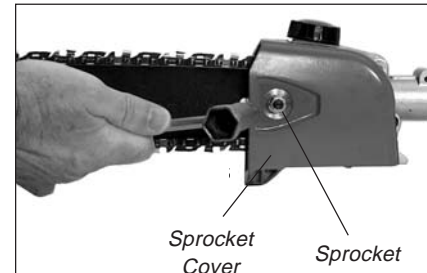

Figure 14

### CAUTION!

Failure to align the guide bar and chain tensioning pin can cause serious damage to the sprocket cover, guide bar, chain tensioning pin and cutting head assembly.

2. Place the guide bar over the guide bar adjustment stud on the cutting head assembly. Align the chain tensioning pin with the hole in the guide bar. See Figure 15.

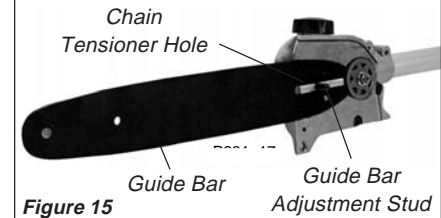
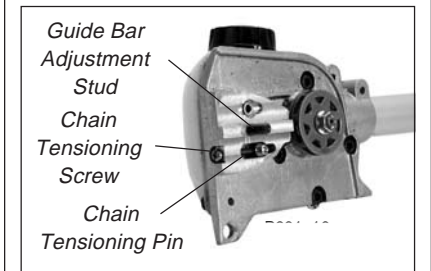

Figure 15

3. Install the chain loop over the drive links within the guide bar groove, and then align the chain over the drive sprocket. Verify that the cutters are properly oriented as shown in Figure 16. If chain installation is difficult or if the chain appears too tight, refer to the section "Adjusting the Chain" on the next page.

4. Install the sprocket cover over the bar stud. Using finger-pressure only, install the sprocket cover nut.

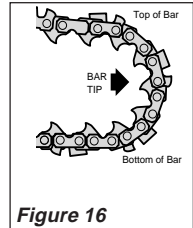

Figure 16

5. Refer to the next page for chain adjusting procedures.



### WARNING!

Never operate the pole pruner without the sprocket cover installed.

## Adjusting the Chain

### **WARNING!**

Never attempt to install, replace, or adjust the chain with the engine running.

### **WARNING!**

The saw chain is very sharp. Wear gloves to protect your hands when handling.

### **CAUTION!**

A loose chain can jump off the guide bar causing damage to the chain and associated equipment. Always make sure the chain is properly adjusted; check more often when you are breaking in a new chain.

### **IMPORTANT!**

Proper chain adjustment is essential for maximum performance, long chain life, and operator safety. Always inspect chain tension before operating the pole pruner.

1. Place the pole pruner on a clean, flat surface. (For readjustment during operation, shut down the engine, then allow the guide bar and chain to cool before proceeding with the adjustment procedure).
2. Loosen the sprocket cover nut with a plug wrench (Figure 17).

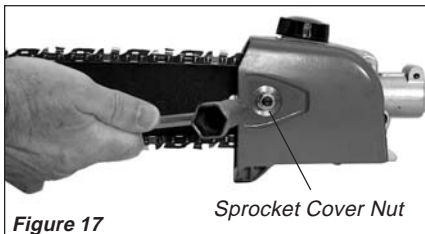

Figure 17

3. Lift the nose of the guide bar while turning the chain tensioning screw. See Figure 18.

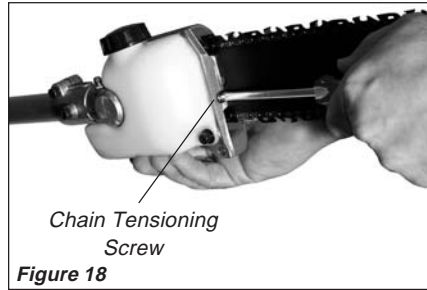

Figure 18

- clockwise to tighten the chain
  - counter clockwise to loosen the chain.
4. Pull the chain by hand along the top of the guide bar several times from the engine to the bar's tip. The chain should feel snug but still pull freely. See Figure 19.

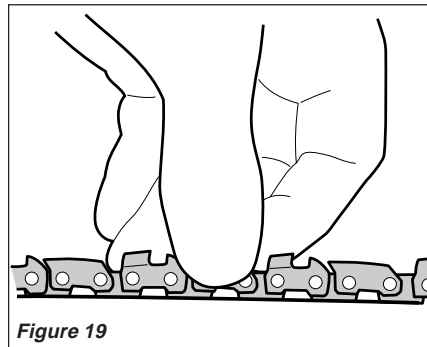

Figure 19

5. Tighten the sprocket cover nut securely while lifting the tip of the guide bar.
6. Inspect the chain for correct adjustment (more frequently with a new chain). The chain should feel snug but still pull freely.

## Stopping the Engine

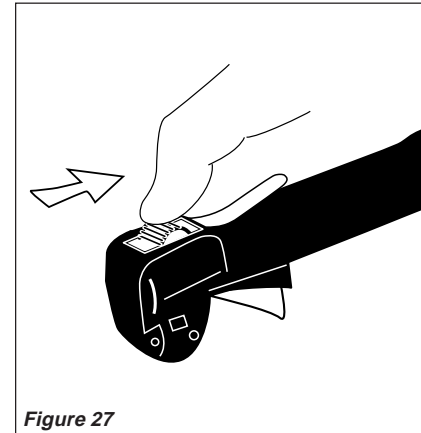

Figure 27

Idle the engine briefly before stopping (about 2 minutes), then slide the ignition switch to the "O" (engine OFF) position. See Figure 27.

## Adjusting Engine Idle

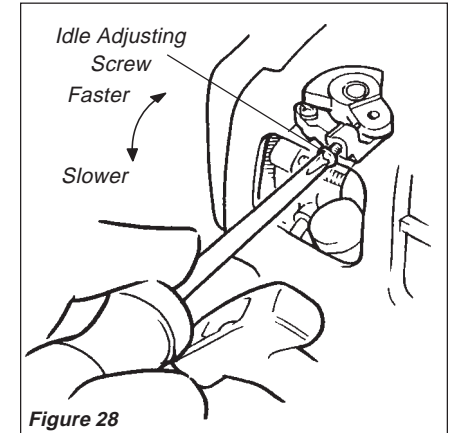

Figure 28

The engine must return to idle speed whenever the throttle lever is released. Idle speed is adjustable, and must be set low enough to permit the engine clutch to disengage the cutting attachment.

### **Check and Adjust Idle Speed**

1. Start the engine and allow it to warm up at low rpm.
2. If the cutting attachment rotates at engine idle, reduce idle speed by turning the idle adjusting screw counter-clockwise. See Figure 28.

### **NOTE:**

Standard idle speed is 2,750 (+/- 250) rpm (min<sup>-1</sup>).

### **WARNING!**

The cutting attachment must NEVER rotate at engine idle! If the idle speed cannot be adjusted by the procedures described here, return the trimmer to your Shindaiwa dealer for inspection.

### **IMPORTANT!**

Units with emission control systems are equipped with factory preset carburetor adjustments. **Only idle adjustment can be done in the field.**



## Starting the Engine (continued)



### WARNING!

The cutting attachment may rotate when the engine is started!

- When the engine starts, slowly move the choke lever to the "OPEN" position. See Figure 26. (If the engine stops after the initial start, close the choke and restart.)

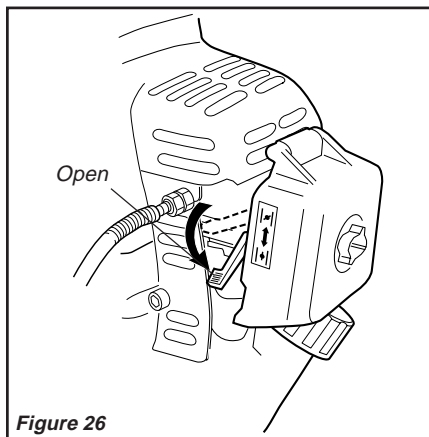

Figure 26



### WARNING!

Never start the engine from the operating position.

### IMPORTANT!

If the engine fails to start after several attempts with the choke in the closed position, the engine may be flooded with fuel. If flooding is suspected, move the choke lever to the open position and repeatedly pull the recoil starter to remove excess fuel and start the engine. If the engine still fails to start, refer to the troubleshooting section of this manual.

### When the Engine Starts...

- After the engine starts, allow the engine to warm up at idle 2 or 3 minutes before operating the unit.
- Advancing the throttle makes the cutting attachment turn faster; releasing the throttle permits the attachment to stop turning. If the cutting attachment continues to rotate when the engine returns to idle, carburetor idle speed should be adjusted (see the next page).

## Chain Oiler



### WARNING!

Never fill the oil reservoir nor adjust the oiler with the engine running.

### IMPORTANT!

The service life of the chain and guide bar is affected by the quality of the lubricant. Using superior lubricant such as Shindaiwa Bar and Chain Oil will help ensure a long service life. For cold weather operation, mix bar and chain oil with an equal part of kerosene.

### Filling The Oil Reservoir

#### NOTE:

The oil reservoir has a capacity sufficient to provide about 40 minutes of cutting time (when set to deliver the minimum flow rate, or about as long as you'll get from a tank of fuel).

- Place the pole pruner on a clean, flat surface with the oil filler cap facing up. See Figure 20. Wipe off any debris from the oil cap and from around the oil filler neck.

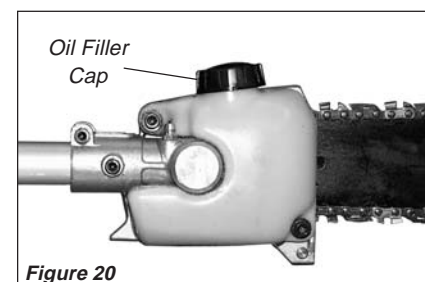

Figure 20

- Remove the oil filler cap and fill the reservoir with bar and chain oil, then replace the cap.
- Wipe up spilled oil from the unit before restarting the pole pruner.

## Adjusting Oil Flow Rate

### CAUTION!

An increase in bar oil flow rate will speed oil consumption, requiring more frequent checks on the oil reservoir. To ensure sufficient lubrication, it may be necessary to check the oil level more frequently than at fuel tank refills.

The guide bar and chain are lubricated automatically by a pump that operates whenever the chain rotates. The pump is set at the factory to deliver a minimum flow rate, but it can be adjusted in the field. A temporary increase in oil flow is often desirable when cutting materials such as hardwood or wood with a lot of pitch.

Adjust the pump as follows:

- Stop the engine and make sure the stop switch is in the OFF position.
- Place the unit on its side with the oil reservoir up. See Figure 21.

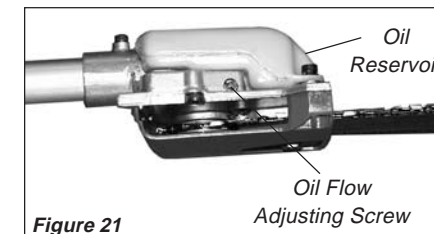

Figure 21

### CAUTION!

The oil flow adjusting screw must be pressed in slightly in order to turn. Failure to do so could damage the pump and screw.

- With a screwdriver, push in on the oil flow rate adjusting screw and turn in the desired direction (there are three incremental settings):
  - clockwise—decrease lubrication.
  - counter clockwise—increase lubrication.

## Mixing Fuel

### CAUTION!

Some types of gasoline contain alcohol as an oxygenate. Oxygenated gasoline may cause increased operating temperatures. Under certain conditions, alcohol-based gasoline may also reduce the lubricating qualities of some 2-cycle mixing oils. Never use any type of gasoline containing more than 10% alcohol by volume! Generic oils and some outboard oils may not be intended for use in high-performance 2-cycle type engines, and should never be used in your Shindaiwa engine.

### CAUTION!

This engine is designed to operate on a 50:1 mixture consisting of unleaded gasoline and ISO-L-EGD or JASO FC class 2-cycle mixing oil only. Use of non-approved mixing oils in catalyst equipped units can lead to excessive carbon deposits.

- Use only fresh, clean unleaded gasoline with a pump octane of 87 or higher.
- Mix all fuel with a 2-cycle air-cooled mixing oil that meets or exceeds ISO-L-EGD and/or JASO FC classified oils at 50:1 gasoline/oil ratio.

### Examples of 50:1 mixing quantities

- 1 gallon of gasoline to 2.6 oz. mixing oil
- 5 litres of gasoline to 100 ml. mixing oil

### IMPORTANT!

Mix only enough fuel for your immediate needs! If fuel must be stored longer than 30 days and **ONE** oil with fuel stabilizer is not used, it should first be treated with a fuel stabilizer such as StaBil™.



### WARNING!

#### Minimize the risk of fire!

- Stop engine before refueling.
- Always allow the pole pruner to cool before refueling!
- Wipe all spilled fuel and move the pole pruner at least 10 feet (3 meters) from the fueling point before restarting!
- Never start or operate this unit if there is a fuel leak!
- Never start or operate this unit if the carburetor, fuel lines, fuel tank and/or fuel tank cap are damaged.
- Never smoke or light any fires near the trimmer or fuel!
- Never place any flammable material near the engine muffler!
- Never operate the engine without the muffler and spark arrester in place and properly functioning!

## Filling the Fuel Tank

1. Place the pole pruner on a flat, level surface.
2. Clear any dirt or other debris from around the fuel filler cap.
3. Remove the fuel cap, and fill the fuel tank with clean, fresh fuel mixture.
4. Install and firmly tighten the fuel cap.



Oil is a registered JASO FC classified oil and also meets or exceeds ISO-L-EGD performance requirements. Shindaiwa One is recommended for use in all Shindaiwa low emissions engines. Shindaiwa one also includes a fuel stabilizer.

## Starting the Engine

### IMPORTANT!

Engine ignition is controlled by a two position switch mounted on the throttle housing labeled, "I" for ON or START and "O" for OFF or STOP.

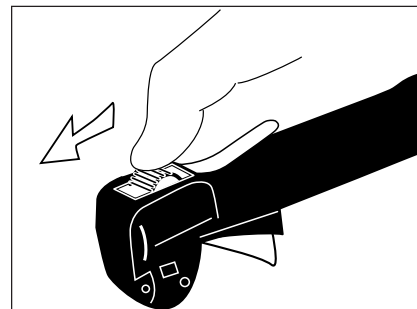

Figure 22

1. Slide the ignition switch to the "I" position (engine ON).

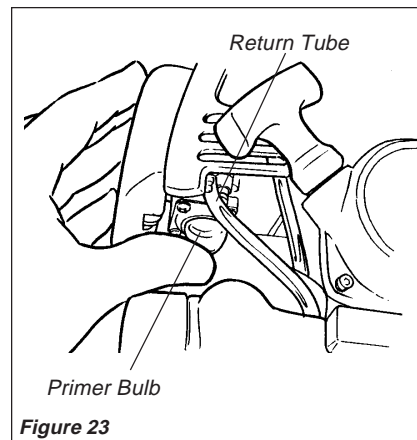

Figure 23

2. Press the primer bulb until fuel can be seen flowing in the transparent return tube.

### IMPORTANT!

The primer system only pushes fuel through the carburetor. Repeatedly pressing the primer bulb will not flood the engine with fuel.

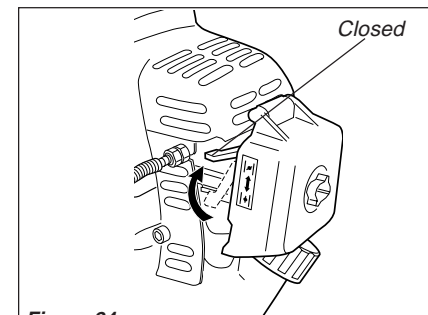

Figure 24

3. Set the choke lever to the CLOSED position if engine is cold.

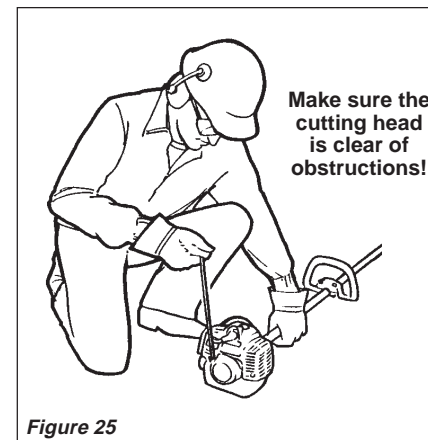

Figure 25

4. While holding the outer tube firmly with one hand, slowly pull the recoil starter handle until resistance is felt, then pull quickly to start the engine.

### CAUTION!

Do not pull the recoil starter to the end of the rope travel. Pulling the recoil starter to the end of the rope travel can damage the starter.

## Free Manuals Download Website

<http://myh66.com>

<http://usermanuals.us>

<http://www.somanuals.com>

<http://www.4manuals.cc>

<http://www.manual-lib.com>

<http://www.404manual.com>

<http://www.luxmanual.com>

<http://aubethermostatmanual.com>

Golf course search by state

<http://golfingnear.com>

Email search by domain

<http://emailbydomain.com>

Auto manuals search

<http://auto.somanuals.com>

TV manuals search

<http://tv.somanuals.com>