

Shiro



• User Manual •

SD8421

Digital Enhanced Cordless Communication

Contents

What the symbols mean	2
The Handset and Base Unit	3
Setting up your telephone	4
Installation	6
Important safety information	8
Warranty Information	9
Making and Answering Calls	10
Message Functions	11
Conference Calling	13
Phone Book	13
Call Information	15
Handset Setting	15
Base Setting	17
Extra Setting	20
Resetting the system	21
Handset Registration	21
Intercom and transfer	22
Troubleshooting	23
Technical details	25
Declaration of conformity	25

What the symbols mean

Battery charge level

Whenever this shows 'nearly empty' () , put the handset on the base unit to charge the batteries. While the battery is being charged, the level shown will keep changing.

Mute

Your handset's microphone is muted.

Signal level

Shows the strength of the signal between the handset and base unit, and flashes when you are out of range of the base unit, when the level is low, or the symbol is flashing, move closer to base unit.

Phone

To indicate there is a missed call.

Speakerphone

Your handset's loudspeaker is on.

Messages

Message has been received.

Lock

Your handset's keypad is locked.

The Handset and Base Unit

Left Key Button

Press to enter menu and sub-menu mode;
Press to confirm selection;
With the key “*” to lock or unlock the keypad; Press during a call to mute the mouthpiece

Right Key Button

In standby mode, press to enter phonebook menu;
Press during programming to go back to the previous option, or to clear digits from the display.

Up and Down Button

Press during programming to move through the menu.
Press during a call to change the volume in the earpiece.

INT button

Press to make an intercom call (if you have more than one handset)

CALL button

Press to begin, answer and end a telephone call.

Speakerphone Button

Press to turn the speakerphone ON/OFF

RECALL button

You need the Recall function if your phone is connected to a PABX, or if you use Select Services. Press to transfer an outside call to another phone.

CHARGE light

The CHARGE light comes on when the handset's batteries are being charged.

IN USE light

The IN USE light comes on when you have a connection to the telephone line.

HANDBSET LOCATOR button

Press this to make the handset ring, if you cannot remember where you put it.
Press it again to stop the handset ringing.

Before you can use the handset to make calls for the first time, you will need to fit and fully charge the battery for 15 hours.

Setting up your telephone

Connection and conditions for use

You can connect your SD8421 to a direct exchange line (DEL), a line connected to a local exchange, with its own phone number; to an extension socket connected to a DEL; or to an extension on an approved compatible PBX. Do not connect the SD8421 as an extension to a payphone.

How many phones can you connect?

The ringer equivalence numbers (RENs) of all instruments (phones, fax machines, etc.) connected to an exchange line must not add up to more than 4, otherwise, one or more of them may not ring and/or answer calls correctly. The SD8421 has a REN of 1, and most other telephones have a REN of 1 unless marked otherwise.

Radio signals between handset and base unit

To use your handset and base unit together, you must be able to establish a radio link between them. Be aware that:

- Sitting the base unit as high as possible will give better results, in a two-storey house, the best position may be on the first-floor landing.
- Any large metal object, like a fridge, a mirror or a filing cabinet, between the handset and base unit may block the radio signal.
- Other solid structures, like walls, may reduce the signal strength.

Choosing a site for the base unit

The base unit should be placed on a level surface, in a position where:

- The mains adapter plug will reach a 230 V AC switched mains supply socket; never try to lengthen the mains power cable.
- The telephone cable will reach your telephone line socket or extension socket.
- It is not close to another telephone, this can cause radio interference.
- It is not close to a sink, bath or shower, or anywhere else where it might get wet.
- It is not close to other electrical equipment, fridges, washing machines, microwave ovens, TVs, fluorescent lights, etc.

What's in this pack

Please check the box contents for completeness.

If any parts are missing, return complete box to your supplier.

- The cordless handset
- The base unit
- 2x Rechargeable battery
- A telephone line cable (different from country to country)
- A mains power lead and adaptor (different from country to country)
- Charger pods (not available for single handset)
- User manual

Note: Keep your proof of purchase to support any guarantee claim.

Installation

1. Choose a suitable site for the base unit

Make sure it is not near to another telephone, nor to other electrical equipment.

2. Plug the mains power lead and the telephone line cord into the rear of the base unit.

3. Plug the mains adapter into a 230 V AC, 50 Hz mains socket with the switch on the socket set to OFF.

Note: The illustration of adaptor may vary from country to country.

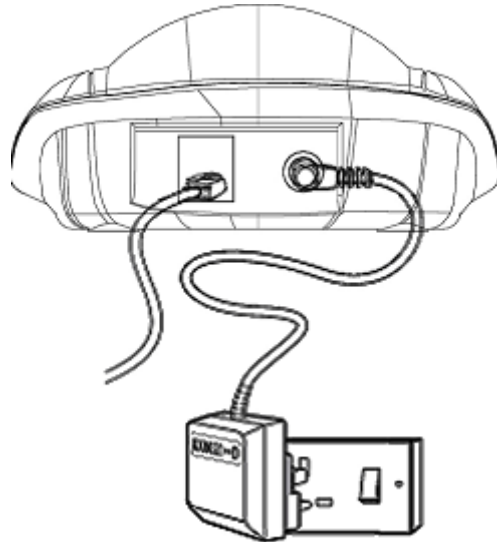

4. Switch on mains power at the socket

5. Fit the battery in the handset(s)

Insert the battery cell following the Battery polarity indication

Push the latch inwards, and then slide the cover until it clicks firmly into position.

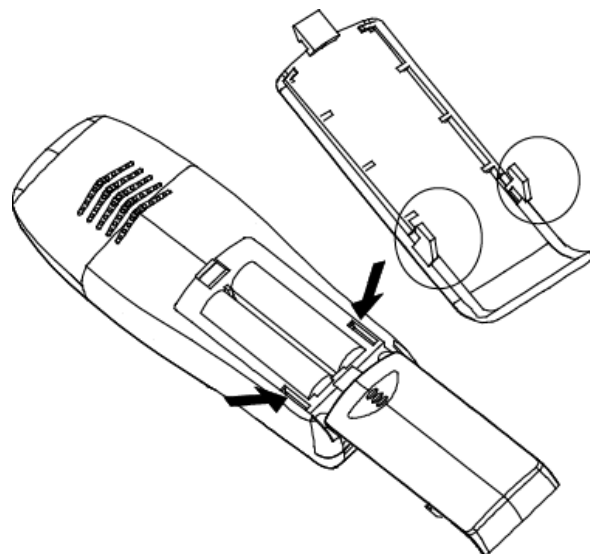
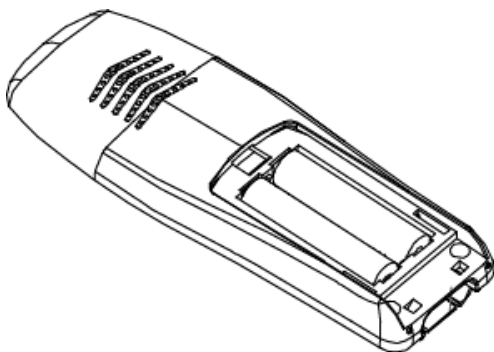

Please note the battery cell polarity during insert.

6. Connect the base unit to the telephone line

Switch off power at the mains socket.

Insert the telephone line plug into the socket.

Switch mains power back on

Make sure the mains socket is switched on if you want to use the phone---it will not work without electrical power.

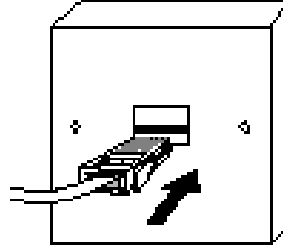

Use the plug to raise the shutter before pushing it into the socket

Note:

- 1. The charge pod does not have a connection to the telephone line.*
- 2. The illustration of telephone's socket may vary from country to country.*

Important safety information

This equipment is not designed for making emergency calls in the event of a power failure. Alternative arrangements should be made for access to emergency services.

(This means that you should also have a basic phone that does not need mains power, connected to your line so that you can make calls during a power failure)

People with a heart pacemaker should consult their doctor before using the telephone.

If you wear a hearing aid, you should note SD8421 works by transmitting radio waves between base and handset that may cause a humming noise.

1. **DO NOT** clean any part of your phone with benzene, thinner or other solvent chemicals, which may cause permanent damage to your phone. This damage is not covered by the Guarantee. When necessary, clean it with a damp cloth.

Cleaning it with a wet cloth may give you an electric shock.

2. **DO NOT** use this equipment in places where volatile or explosive materials may be present.

3. **DO NOT** let the base unit get wet. Electrical equipment can cause serious injury if used while you are wet or standing in water. NEVER use your phone during a thunderstorm. Unplug the base unit from the telephone line and the mains socket when there are storms in your area. Damage caused by lightning is not covered by the Guarantee.

4. The SD8421 will produce a certain amount of heat during operation. For this reason it is recommended that this equipment is **NOT** placed in direct contact with antique, veneered or delicate furniture surfaces.

5. **DO NOT** dispose batteries with normal household waste.

6. The SD8421 DECT phone emits radio signals which could interfere with other electronic equipment, computers, radio, TV set, clock radio alarms, etc.

A distance of at least one meter should be maintained between SD8421 base station and other equipment. This will minimize the risk of such interference.

7. When you do not need to carry your handsets around, leave them on the base unit or charger pod, to keep the batteries charged.

8. If you hear a warning tone as move around during a call, and/ or the sound in the earpiece becomes faint or distorted; you may be going out of range of the base unit.

Move nearer to the base unit within 20 seconds, until the tone stops. Otherwise your call may be cut off.

Warranty Information

Your phone is covered by a 12-month warranty from the date of purchase shown on your sales receipt. The warranty does not cover the batteries, misuse or damage caused by a storm or excessive voltages.



If you have any problems using the phone, check the Troubleshooting section at the back of this manual. If you need to return your SD8421 to our Repair Center while it is under guarantee, there will be some handling charge.

Making and Answering Calls

To Make a Call

1. Key in the telephone number;
2. Press the **CALL**  button to make a call.

To Dial a Number from Call Logs

1. Select <Missed Calls>, <Received Calls> or <Dialed Calls> under *CALL LISTS* mode;
2. Press left  key, the display shows these calls;
3. Select the telephone number you want to call, then press the **CALL**  button to make call

To Answer a Call

- When the handset and base unit ring, press the **CALL**  button to answer a call.
- When the AUTO TALK is turned on, you can simply answer the call by lifting the handset from the base unit (see *AUTO TALK*).

To End a Call

- When the talking is over, you just press the **CALL**  button to end the call.



To Save a Call

- When you scroll through the dialed, received and missed calls numbers, press left  key, then select <Save>, you can save the call number and name.

Earpiece Volume

- During a call, you just press **UP / DOWN**  button to adjust the volume of the earpiece (0-9 level).

To Mute the Mouthpiece

- During a call, if you want the person on the other hand end cannot hear you; press left  key once to mute the mouthpiece;
- While the mouthpiece is muted, you cannot press any number key to send digits down the line;
- Press left  key again to get back to the Call.

To Switch the Handset ON or OFF





- Press and hold the  button for 2-3 seconds to switch the handset ON or OFF.

Message Functions

SD8421 is equipped with text message function, which allows you to send and receive SMS (Short Message Service) from other compatible fixed line SMS phones. You need to register with your fixed line network operator for the SMS service before using SD8421 for messaging. Inbox, Outbox and Draft box can store up to 40 text messages together.



Inbox

The Inbox is to store the received messages. In order to keep enough space for messages, you should delete messages frequently.

- Select <Inbox> under *MESSAGE* mode, press left  key, a list of received messages is displayed. Press **UP/DOWN**  button to scroll through the messages
- The text of message is displayed, then press left  key, the display shows the details of the message, including the date and the time the message is received;
- After message is read, press left  button, you can delete, reply, forward or save number.



Outbox

Outbox contains messages you have failed to send, the message will auto-send every five minutes until send successfully.

- Select <Outbox> under *MESSAGE* mode, press left  key, a list of messages sent failed are displayed. Press **UP/DOWN**  button to scroll through the messages;
- Then you can edit, delete, save or send the message.

Draft

Draft contains messages you have saved.



- Select <draft> under *MESSAGE* mode, press left  key, a list of saved messages are displayed. Press **UP/DOWN**  button to scroll through the messages;
- Then you can edit, delete or send the message.

To Read Message

- Under <MESSAGE> menu, select Inbox, Outbox or Draft, then press left  key, you can read messages if there's stored messages.



To Write Message

1. Select <Writer Message> under *MESSAGE* mode;



2. Enter text using the number keypad. Press right  key once to clear one letter; press and hold right  key to clear the screen;
3. Use **UP/DOWN**  button to backspace;
4. For symbols, the key “1” is used for the following symbols: . , ’ ? ! “” - () @ / : _ 1; the key “*” is used for the following symbols: * ; + & % = < > \$ [] { } \ ~ ^, you can press continuous till choosing the symbol you want.
5. Press number “0” once, it is used for Spacebar. Press number “0” twice, it is used for “0”

Note: If text entry is interrupted, the message will be saved in the “Write Message” option for later access.

To Send Message

1. After entering a message, then press left  key, you can choose to send message to one number, or to many numbers;
2. Key in the number, then press left  key to confirm, the display shows “Sending...”;
3. When the message is successfully sent, the display shows “Message has been sent successfully.”
4. If sending fails, the screen will display “Send failed”;
5. The sent message will not be saved automatically.



To Save Message



- After you type a message, press left  key, then select *Save message*;
- Press left  key again to save this message to Draft,, the display shows “Saving...”

To Toggle Between Upper/Lower Case, Number or Symbol

Note: Under SMS Write Message, press # button to toggle between Upper/Lower Case, Number or Symbol. Press **OK** button to make the settings permanent.

To Clear All message





- Select <SMS Setting > under *MESSAGE* mode, Press left  key and **UP / DOWN**  button, and goes to the location *Clear All*;

- Press left  key , then the display shows “Delete?”;
- Press left  key to confirm, then the display show “Deleted”. All messages in inbox、 outbox and draft are deleted.

SMS Setting

To send and receive SMS messages, you need your SMS Message Center numbers.



To Change SMS Send/Receive Center NO

- Select <SMS Setting > under *MESSAGE* mode, Press left  key and **UP / DOWN**  button, and goes to the location *send/receive center*;
- Press left  key, you can see the preset number. Press right  key to clear the number and key in new number;
- Press left  key to confirm, the display shows “Saving...”

Conference Calling

You need to register with your fixed line network operator for conference calling service. It is dependant on service availability and subscription.



To Make Conference Call:



- Connect the first party;
- Press **INT**  button, and the first party is put on hold;
- Dial second party’s phone number;
- When connected, press **INT**  button again to connect the three parties together.

Phone Book





Up to 50 or 100 (depending on your country location) records could be stored in each handset's Phone Book. Each record can store up to 20 digits, and names of up to ten characters. In standby mode, press right  key, and the display shows phonebook list.

To Store New Number into Phonebook









1. In standby mode, press right  key, enter Phonebook mode, the display shows the stored numbers;
2. Press left  key and **UP / DOWN**  button, and goes to the location *New Entry*;

3. Then press left  key again, and key in the name;
4. Press left  key to confirm, and key in the number;
5. Now press left  key to store it.

To Delete a Number or All Numbers from Phonebook

1. Under Phonebook mode, press **UP / DOWN**  button to scroll through the stored numbers;
2. Select the number you want to delete, then press left  key, then **UP / DOWN**  button till to the location *Delete*;
3. Now press left  key to delete current number or all numbers; the display shows *Delete?* ;
4. Press left  key to delete the number/numbers.

To Modify (Change) a Number in Phonebook

1. Under Phonebook mode, press **UP / DOWN**  button to scroll through the stored numbers;
2. Select the number you want to modify, then press left  key, then **UP / DOWN**  button to the location *Edit Entry*;
3. Press left  key to confirm, and right  key to clear the old name, then key in the new name;
4. Press left  key to save the edit, also goes to the stored number; press right  key to clear the old number and key in the new number;
5. Then press left  key to save the change

To Check Memory

You can use this feature to see how many of your Phone Book's 50 locations have been not used.







1. In standby mode, press right  key, enter Phonebook mode, the display shows the stored numbers;

2. Press left  key and **UP / DOWN**  button to the location *memory*
3. Press left  key, the display shows “ n Left”.

Call Information



You must subscribe to Caller ID service from your service provider to use this feature. Call Logs store information related to received calls, missed calls and dialed calls. SD8421 can store up to a maximum of 30 calls, consisting of 10 received, missed and dialed calls respectively.

To Check Call Records



1. In standby mode, press left  key, goes to *CALL LIST* (Call Information) mode;
2. Press left  key again, the display shows *Missed Calls, Received Calls, Dialed calls* and *Clear All Calls*;
3. Then press left  key again, the display shows these calls numbers;
4. Select one number, then press left  key, and **UP / DOWN**  button to the location *Show Details*;
5. Press left  key, then the display shows the details of the call, including the call number, and the date and time the call is received or dialed.



Handset Setting

To Set Wall Paper





1. Select < *Wall Paper*> under *HANDSET* mode;
2. Press left  key to confirm, and press **UP/DOWN**  button to scroll through the pictures;
3. Choose the picture you prefer, then press left  key to confirm, now the picture is set to the wallpaper of the handset.

To Set External/Internal Ringer Volume (1 -5 level)

1. Select < *Ringer Set*> under *HANDSET* mode;
2. Press left  key to confirm, then **UP/DOWN**  button to the location *ExternalVo/InternalVol*;





3. Press left  key and **UP/DOWN**  button to choose the volume level you want to set;
4. Then press left  key to confirm the choice.

To Set External/Internal Ringer Melody (1-9 melody)



1. Select < Ringer Set> under *HANDSET* mode;
2. Press left  key to confirm, then **UP/DOWN**  button to the location *ExternalRing / InternalRing*;
3. Press left  key and **UP/DOWN**  button to choose the ring melody you want to set;
4. Then press left  key to confirm the choice.

To Set Key Tone On/Off



Each time you press a key on your handset, you hear a tone. You can turn this off if needed.

1. Select < Ringer Set> under *HANDSET* mode;
2. Press left  key to confirm, then **UP/DOWN**  button to the location *Key Beep*;
3. Press left  key and **UP/DOWN**  button to set the key beep ON/OFF;
4. Press left  key to confirm.

Auto Talk Function



Normally, you need to press the **CALL**  button to answer an incoming call. But with *AUTOTALK* function turned on, when your handset is ringing for an incoming call, you can answer the call by simply lifting the handset from the base unit without pressing the **CALL**  button.

To Set Auto-Talk Function ON/OFF:



1. Select <Auto-talk> under *HANDSET* mode;
2. Press left  key, and **UP/DOWN**  button to set Auto-talk ON/OFF;
3. Then press left  key to confirm;

! If you have turned Auto-talk on, do not press the **CALL**  button after you've answered a call by lifting the handset, otherwise, you'll disconnect the call.

To Set Handset Name



1. Select <Handset Name> under *HANDSET* mode;
2. Press left  key to confirm;
3. Key in your chosen name;
4. Then press left  key to confirm;

To change Handset Name

1. Select <Handset Name> under *HANDSET* mode;
2. Press left  key to confirm, the display shows the current name;
3. Press and hold the right  key to clear the old name, then key in the new name;
4. Press left  key to confirm to the change.



To Set Language

You can change the default language into any language you prefer.

1. Select <Language> under *HANDSET* mode;
2. Press left  key and **UP/DOWN**  button to choose the language you prefer;
3. Then press left  key to confirm the setting

To set SMS Alert ON/OFF

Each time you receive a message, you will hear a tone. You can turn this off if needed.



1. Select <SMS Alert> under *HANDSET* mode;
2. Press left  key and **UP/DOWN**  button to set the SMS Alert ON/OFF;
3. Then press left  key to confirm the setting

To Lock /Unlock the Keypad



- Press left  key and “ * “ button consecutively to lock/unlock the keypad.

Base Setting

To Set Base Melody (1-9 melody)



1. Select < *Ringer Settings* > under *BASE* mode;
2. Select < *Ringer Melody* > under *Ringer Settings*;
3. Press left  and UP/DOWN  button to set the melody you prefer;
4. Press left  key to confirm.

To Set Base Volume (0-4 volume level)

1. Select < *Ringer Settings* > under *BASE* mode;
2. Select < *Ringer Volume* > under *Ringer Settings*;
3. Press left  key and UP/DOWN  button to set the volume you like;
4. Press left  key to confirm.





To Set Flash Time

With the FLASH function, you may select Short or Long flash time for your PABX. You may activate FLASH by pressing **R** button. To set FLASH:

1. Select < *Dial Settings* > under *BASE* mode;
2. Select < *Flash Time* > under *Dial Settings*;
3. Press left  key and UP/DOWN  button to change Flash Time to Long or Short;
4. Press left  key to confirm



To Set Auto Pause

With the Auto Pause function, the phone will automatically pause for 3 seconds once the initial string of the phone number matches the PABX code. For example, if the user program to enter "9" as PABX code, then when he dials "98118118", then the phone will dial "9" first then pause for 3 seconds follow by "8118118". To set Auto Pause:

1. Select < *Dial Settings* > under *BASE* mode;
2. Select < *Auto Pause* > under *Dial Settings*;
3. Press left  key, then key in PIN (default 0000)
4. Press left  key, the display show *Number 1*
5. Press left  key, then key in the number you want to set auto pause.
6. Press left  key to confirm.

To Set Dial Mode



You can change dial mode to TONE or PULSE dialing.

1. Select < *Dial Settings* > under *BASE* mode;
2. Select < *Dial Mode* > under *Dial Settings*;
3. Press left  key and **UP/DOWN**  button to change dial mode as TONE or PULSE;
4. Press left  key to confirm.



Call Barring Function

Call barring enables you to restrict or bar certain types of calls from your phone.



To Set Call Barring Number



1. Select < *Call Barring* > under *BASE* mode;
2. Select < *Barring Number* > under *Call Barring*;
3. Press left  key, then key in the PIN (the default PIN is 0000);
The display shows one of the numbers from 1 to 5 (the maximum call barring numbers you can set), and then key in the telephone number you want to set call barring.
4. Press left  key, and then the display shows *HS?*
Key in the handset number that you want to set call barring
5. Press left  key to confirm.

To Delete Call Barring Number



1. See 1-3 step above, then press left  key;
The display shows the call barring number you set
2. Press and hold right  key to clear the number;
3. Press left  key to confirm.

To Change Base PIN

1. Select < *PIN* > under *BASE* mode;
2. Press left  key, and key in the original PIN (default PIN:0000) number;
3. Then press left  key to confirm, and key in New PIN;

4. Press left  key, then key in New PIN again;
5. Press left  key to confirm.

Default Settings



1. Select *<Default settings>* under *BASE* mode;
2. Press left  key, and key in the original PIN (default PIN:0000) number;
3. Press left  key to confirm, you will hear a beep, then all features will return to their default settings.

The following is default settings for you reference.



- 1). Reset Flash time to Long,
- 2). Delete call barring number.
- 3). Reset master pin number to 0000.
- 4). Reset ringer melody and volume.
- 5). Dial mode reset to Tone.
- 6). Reset DTAM ring (if any).
- 7). Remove Auto Pause number.
- 8). Remove LCR (if any).
- 9). Reset SMSC settings.

Extra Setting

To Set Alarm Time

1. Select *< Alarm Set >* under *EXTRA* mode;
2. Press left  key, then key in the time;
3. Press left  key to save;

To Set Clock Time

1. Select *< Clock Set >* under *EXTRA* mode;
2. Press left  key, then key in the time;
3. Press left  key to save;

To Set Clock Date



1. Select *< Clock Date >* under *EXTRA* mode;
2. Press left  key, then key in the date;

3. Press left  key to save;

Resetting the system

If you have set a PIN and forgotten it, you need to reset the system. The PIN will be reset to 0000. If you reset the system, you will lose all stored information (including numbers in memory) and all features will return to their default settings.









While you are resetting the system, you should disconnect the telephone line cord from the back of the base unit, so you won't be interrupted by incoming calls. To reset the system without the PIN:

1. Disconnect the power lead from the back of the base unit;
2. Press and hold the **HANDSET LOCATOR**  button in the base unit;
3. Connect the power lead into the back of the base unit. After you hear "beep" sound for five times, then release the **LOCATOR**  button
4. You will hear confirmation tone from the base unit.

Handset Registration



Your SD8421 is supplied with the handset already registered to the base unit, and you shouldn't need to register it. But if you've bought extra handset, you'll need to register each one to your original base unit. Maximum 5 handsets can be registered to one base.

To register a handset

1. Press and hold the **Handset locator**  button on the base unit for a while, until you hear "beep" sound twice continuously;
2. Press left  key, then **UP/DOWN**  button to the location *REGISTRATION*;
3. Press left  key, then **UP/DOWN**  button to the location *BASE SUB*;
4. Press left  key again
The display shows *BASE 1; BASE 2; BASE 3; BASE 4*;
5. Press **UP/DOWN**  button to scroll through the base, and press left  key, then enter base PIN(Default: 0000), and press left  key to confirm;
The display shows *SEARCH + selected number*
After a while, when the handset finds the base unit, the display shows *PIN*
6. After a while, when the handset finds the base unit, it goes back to the standby mode.

To de-register a handset

You may need to do this if you have more than one handset registered to your base unit and you need to replace a faulty handset.

1. Select <de-register> under *REGISTRATION* mode.
2. Press left  key, then key in the PIN (default 0000).
3. Press left  key, then key in the number of the handset you want to de-register.
4. Press left  key to confirm.

Note: You cannot de-register the handset you are currently using.

Intercom and transfer



To make an intercom call

1. Press the **INT**  button
You hear Dial tone
2. Key in the number of the other handset

On the other handset's display, your number appears, and the **INT** symbol flashes. Then the other handset user presses the **CALL**  button to connect the call.

For details of how to change the ringing melody and volume for intercom calls, see "INT MELODY" and "INT VOLUME" under "HANDSET SETTING" part.

To end an intercom call



- Press the **CALL**  button on your handset. The other person will hear Busy tone, and also need to press the **CALL**  button to hand up.

To transfer a call

To transfer the outside call to another handset (if you have two or more handsets):

- Press the **INT**  button and key in the number of the other handset.
- The outside call is put on hold. When the other handset answers, you can speak to the user. If the other handset does not answer, you can get back to the outside call by pressing the INT button again.

To transfer the outside call to another outside phone:

- Press the **RECALL**  button and key in the call number you want to transfer.
- The outside call is put on hold. When the call answers, you can speak to the user, then press the **CALL**  button to hang up and transfer the call.

Troubleshooting

If you experience difficulties with the working of your SD8421, refer to the advice given below.

1. "The handset does not ring"

Check the base unit's mains power adaptor is plugged in and power is switched on. The base unit needs mains power for normal operation of the phone, not just for charging the batteries.

Make sure you are using the telephone line cable that was supplied with your SD8421. Other telephone line cables might not work.

2. "There is no dial tone"

Check that the handset is registered to the base station.

Check that the line cord is securely connected at both ends and is undamaged.

Check the power to the base station is on and connected.

3. "The base does not ring."

Check that the base power is ON, and the base ringer is set ON.

Check that the line cord is correctly fitted and undamaged.

4. "The CHARGE light on the base unit does not come on."

Check the handset is properly stationed.

Check the connections between the base unit and mains power socket.

Clean the battery charging contacts with a dry cloth.

5. "When I press the CALL button, I hear a loud noise."

The strange noise is caused by interference. Disconnect the mains power lead from the back of the base unit, and then wait for 30 seconds before reconnecting it.

6. "There is 'beep' sound while I am on a call."

You may be going out of range of the base unit. Move closer, or your call may be cut off.

Check the Battery Level symbol on the display. If it is low, recharge the batteries.

7. "I cannot make or answer calls."

Move the handset closer to the base unit.

Try a different location for the base unit, perhaps higher, or further from other electrical equipment.

Check the Battery Level symbol on the display. If it is low, replace the handset on the base unit to recharge the batteries.

Switch off power at the mains socket, wait for a few seconds and then switch back on.

8. "The handset's battery are running low within an hour or two."

Before you used the handset for the first time, you should have left it on the base unit for up to 15 hours to charge the battery fully.

You may need to replace the battery.

9. "Last Number Redial and/or memory dialing don't work on a PBX."

When you first make a call, try press the # button for a pause between the outside line access digit and the telephone number.

You should later be able to redial the number.

10 "I cannot transfer a call."

Make sure the other handset is within range of the base unit, and is not busy on a call.

Make sure you are keying in the correct number for the other handset.

Technical details

Full DECT GAP Compatible system

Standard

Frequency range	1.88 to 1.9 GHz
Channel bandwidth	1.728 MHz
Modulation	GMSK
Operating range	Up to 300 m outdoors; Up to 50 m indoors
Operating time	Standby time: 100 hours Talking time: 8 hours
Temperature range	Operating 0 ⁰ C to 40 ⁰ C Storage -20 ⁰ C to 60 ⁰ C
Electrical power	Handset---2x 1.2V 750 mAH Ni-MH, rechargeable batteries Base unit---input 230 V AC, 50 Hz; output AC 9 V, 300 mA.
PABX compatibility	Pause length: 3 seconds. Signaling type: DTMF (dual-tone multifrequency) Pulse dialing

Declaration of conformity

The SD8421 complies with the essential protective requirements and objectives of:

- EC R& TTE Directive 1999/5/EC
- EC Low Voltage Directive 73/23/EEC
- EC EMC Directive 89/336/EEC

And conforms to the following relevant harmonized standards:

- Radio: TBR 6
- EMC: EN 301489
- Safety: EN 60950
- Other: TBR 22



Free Manuals Download Website

<http://myh66.com>

<http://usermanuals.us>

<http://www.somanuals.com>

<http://www.4manuals.cc>

<http://www.manual-lib.com>

<http://www.404manual.com>

<http://www.luxmanual.com>

<http://aubethermostatmanual.com>

Golf course search by state

<http://golfingnear.com>

Email search by domain

<http://emailbydomain.com>

Auto manuals search

<http://auto.somanuals.com>

TV manuals search

<http://tv.somanuals.com>