

SINGER

Class 99 & 99K Sewing Machines

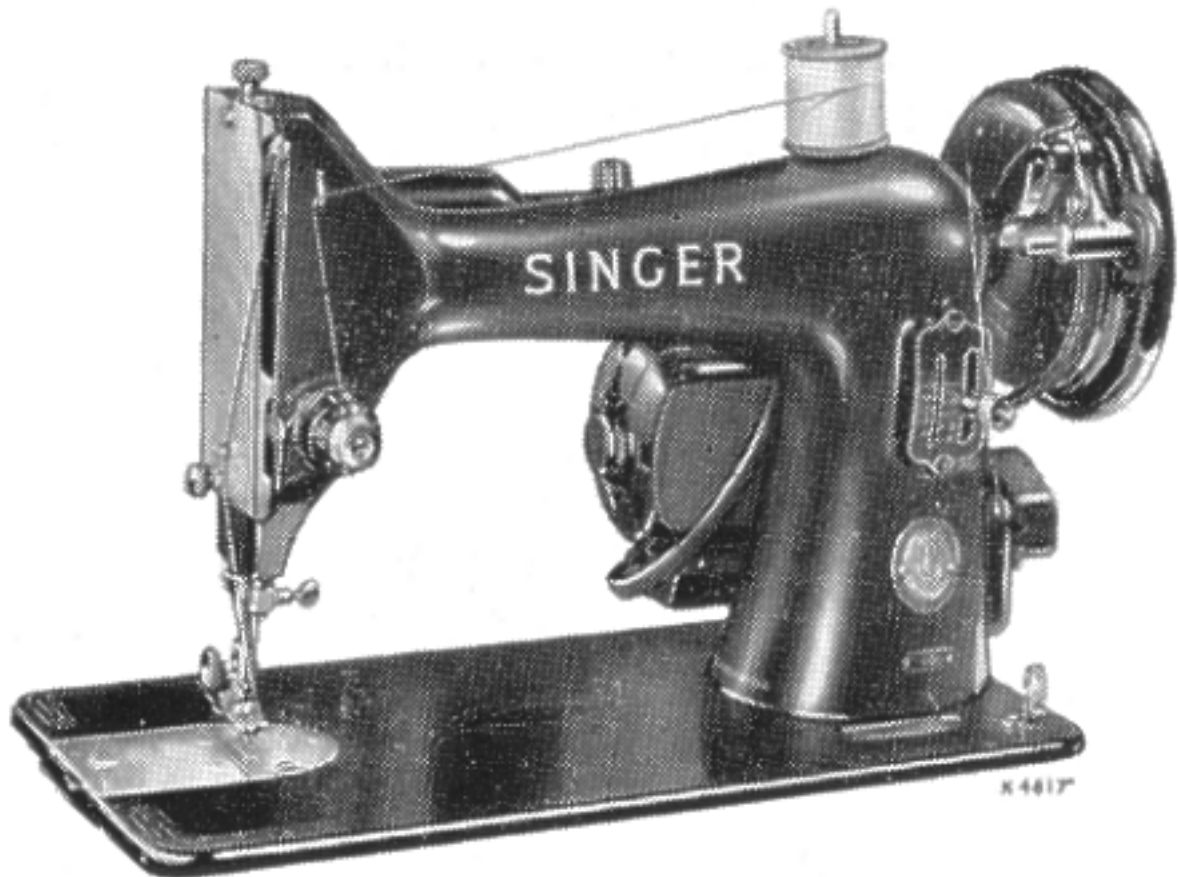

Instruction Manual

Table of Contents | Next Page

SINGER Class 99 & 99K

Table of Contents

Instructions for Operating the Machine

[Electrical Information](#)
[Remove and Replace Light Bulb](#)
[Operate Electrically](#)
[Operate by Hand](#)
[Treadle Operation](#)
[Protection Against Rust Damage](#)
[To Oil the Machine and Stand](#)
[Needle Size Chart](#)
[To Set the Needle](#)
[Upper Threading](#)
[To Remove the Bobbin](#)
[To Wind the Bobbin](#)
[To Replace the Bobbin](#)
[To Prepare for Sewing](#)
[To Start Sewing](#)
[To Turn a Corner](#)
[Basting](#)
[To Sew Bias Seams](#)
[To Remove the Work](#)
[To Regulate Length of Stitch](#)
[To Reverse the Direction of Feed](#)
[To Regulate Pressure on Presser Foot](#)
[Thread Tension](#)
[To Regulate Needle Thread Tension](#)
[To Regulate Bobbin Thread Tension](#)
[To Adjust Needle & Bobbin Tensions](#)
[To Remove Bobbin Case](#)
[To Replace Bobbin Case](#)
[To Replace Slide Plate](#)

Sewing Suggestions

[The Belt](#)
[To Avoid Breaking Needles](#)
[Breaking of Needle Thread](#)
[Breaking of Bobbin Thread](#)
[Skipping of Stitches](#)
[Machine Working Heavily](#)

Instructions for Using the Attachments

[The Foot Hemmer](#)
[Hemming](#)
[Hemmed Seams](#)
[Hemming with Lace](#)

[The Binder](#)
[Inserting the Binding](#)
[Adjustment & Operation of the Binder](#)
[Binding Curved Edges](#)

[The Gathering Foot](#)
[Shirring](#)

[The Ruffler](#)
[To Adjust the Ruffler](#)
[To Activate Parts of the Ruffler](#)
[Gathering](#)
[Forming & Attaching a Ruffle in One Operation](#)
[Pleating](#)
[Group Pleating](#)

[The Seam Guide](#)

[The Zipper Foot](#)
[Preparation](#)
[Inserting a Skirt Zipper](#)
[Sewing Corded Welting](#)
[Sewing Corded Seams](#)

[Fashion Aids](#)
[The Buttonholer](#)
[The Blind Stitcher](#)
[The Bias Gauge](#)
[The Edge-Stitcher](#)
[The Quilter](#)
[The Adjustable Hemmer](#)
[The Tucker](#)
[Darning or Embroidering](#)

[Singer Needles and Oil](#)

SINGER Class 99 & 99K

ELECTRICAL INFORMATION

The **Singer electric motor** is located at the back of the machine, and can be supplied for operation on alternating or direct current. Orders must state the catalogue number of the motor, or the voltage, and in the case of alternating current, the number of cycles.

Before inserting electrical plug, be sure that voltage and number of cycles stamped on motor nameplate are within range marked on electric meter installed by electric power company.

Electrical Connections for Machine: Push three-pin safety plug into three-pin terminal block at right of machine and connect plug at other end of cord to electric supply point.

Speed Controller: The speed of machine is regulated by amount of pressure on foot or knee controller.

CAUTION! When you have finished your sewing always disconnect the plug from the electric supply point.

LIGHT

To turn light "on," reach over machine arm and turn switch **V**, **Fig. 1** to right. To extinguish light, turn switch to left.

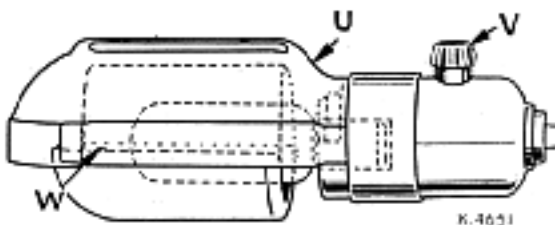

Fig. 1. Light.

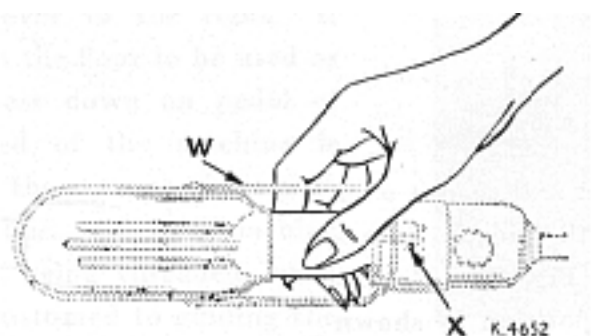

Fig. 2. Removing and replacing bulb.

SINGER Class 99 & 99K

To Remove Bulb

Grasp light socket so that thumb extends over switch **V**. Press shade with thumb at **U**. to release shade from two catches, and slide it halfway out of shade holder **W**. Press bulb into socket and at same time, turn bulb over from machine as far as it will go to unlock pin **X** (see **Figs. 3** and **4**). Withdraw the bulb.

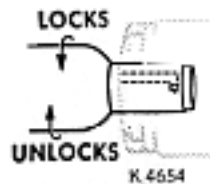

Fig. 3. Locking or unlocking bulb pin.

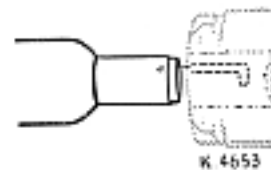

Fig. 4. Inserting bulb in socket.

To Insert New Bulb

Press bulb into socket and turn it over toward machine until pin **X** enters notch in socket (see **Fig. 3**). Return shade to its normal position as shown in **Fig. 1**.

SINGER Class 99 & 99K

If the Machine is Electrically Operated

Raise presser foot **Q** by means of presser bar lifter **R** to prevent injury to the foot **Q** and feed **T**.

Place a piece of material under presser foot and let the foot down upon it. Turn on electric current and, if the combination knee and foot controller is installed as a knee controller, press knee lever to the right. If controller is placed on the floor to be used as a foot controller, press down on pedal of controller. The speed of the machine is controlled entirely by the amount of presser applied to the controller. Operate machine in this way, without being threaded, until you have become accustomed to guiding the material and operating the controller.

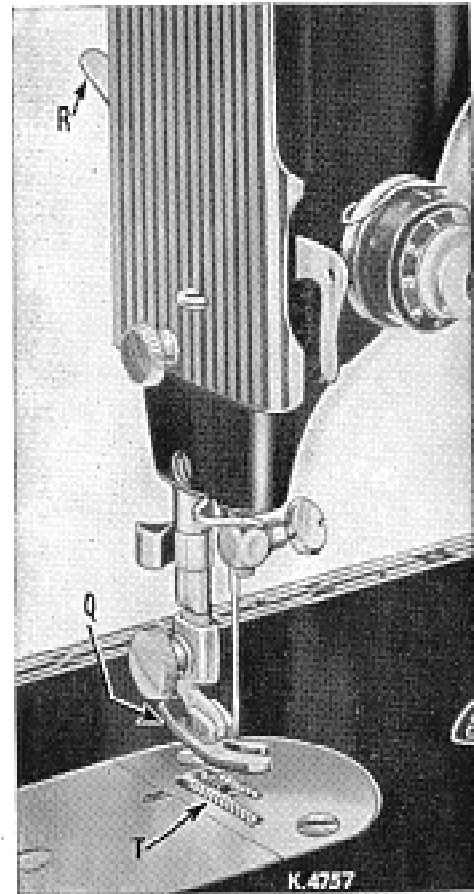

Fig. 5. Front view of machine.

SINGER Class 99 & 99K

If the Machine is Hand Operated

When the machine is uncovered, the hand attachment will be found to be out of working position as shown in **Fig. 6**. Pull the small spring stud **2**, and turn the handle back until leer **1**, enters the socket **3**. Press back the hinged finger **4**, **Fig. 7** between the spokes of the wheel. The machine is now ready for working as shown in **Fig. 7**.

NOTE. Before replacing the cover on the machine in its case, the lever should be disengaged and the handle placed in the position shown in **Fig. 6**.

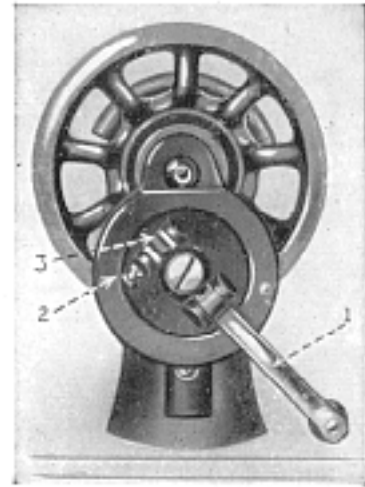

Fig. 6.

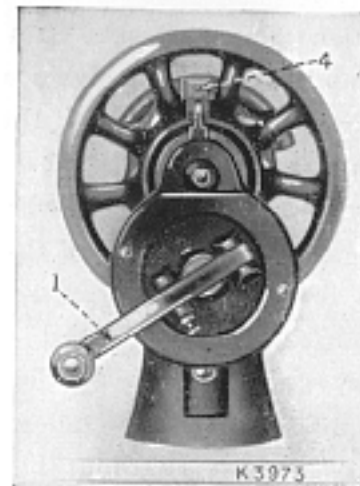

Fig. 7.

To Operate the Hand Machine

Place a piece of material under the presser foot **Q**, **Fig. 5**, and lower the latter by means of the lifter **R**. Now turn the handle **over from you** to work the machine, without being threaded, until you are accustomed to guiding the material with the left hand.

SINGER

Class 99 & 99K

If the Machine is Treadle Operated

Loosen the hand wheel by turning motion screw **L**, **Fig. 16**, over toward you, place both feet upon the treadle and turn the hand wheel over toward you, at the same time allowing the feet to move freely and lightly with the motion of the treadle. Continue to do this until a regular and easy movement is acquired and you are able to work the treadle so that you can re-start the machine with the wheel turning toward you.

When familiar with the working movement, tighten the hand wheel by turning the stop motions screw over from you, and place a piece of material under the presser foot **Q**, **Fig. 5**. Lower the latter by means of the lifter and again work the machine without being threaded, until you are accustomed to guiding the material.

The belt should be only just tight enough not to slip. If too loose shorten and rejoin.

Belt Shifter

This device simplifies throwing off and replacing the belt. To throw off the belt, move the belt shifter to the left (see **Fig. 8**), working the treadle at the same time. To replace the belt, work the treadle slowly with the hand wheel turning toward you, when a revolutions or tow of the wheel will bring the belt back into its place.

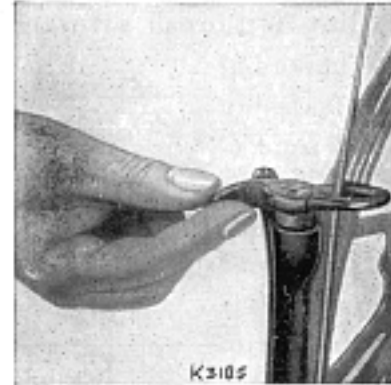

Fig. 8.

SINGER Class 99 & 99K

Protection Against Rust Damage

Lint and fluff, if not removed prior to storage will, during humid periods, absorb and hold moisture, and thus accelerate rust damage to highly polished thread handling and other exposed parts. The extend of rust damage would depend upon the length of time the machine remained in idle storage where there is no ventilation. Sudden drops in temperature till cause moisture to form on parts which, if not protected by a film of oil, would rust and damage while in storage.

Proper storage care suggests thorough brush-cleaning to remove all traces of lint and fluff, followed by swabbing of all the exposed parts in **Figs. 10** and **11** with a lint-free brush saturated with SINGER oil. SINGER lint-free brush may be purchased at your local SINGER dealer.



Page 8

[Table of Contents](#) | [Previous Page](#) | [Next Page](#)

SINGER Class 99 & 99K

To Oil the Machine and Stand

If the machine is used continuously, it should be oiled daily. If moderately used, an occasional oiling is sufficient. Apply one drop of oil at each of the places indicated by the unlettered arrows in **Figs. 9, 10 and 12** and carefully clean the machine to insure smooth and satisfactory performance. Oil holes are provided in the machine for bearings which cannot be directly reached.

Remove face plate **D, Fig. 9** by taking out screw **C** and loosening screw **E** near the top of the place. Slip plate over screw **E**. Oil the points indicated in **Fig 10** and then replace face plate **D**.

Draw the slide to the left (as shown in **Fig. 9**) and, after removing the lint and dust which may have accumulated (see instructions on **page 24**), apply a drop of oil at the place indicated at **F, Fig. 11**. The slide should then be closed.



Fig. 9

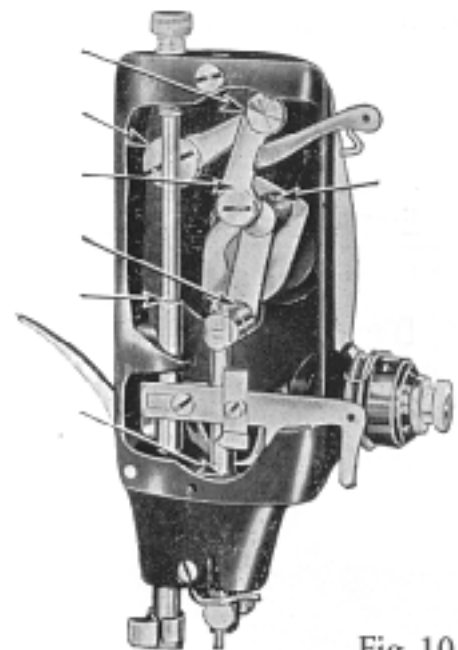

Fig. 10

SINGER Class 99 & 99K

To oil the parts underneath the bed of the machine, turn the machine back on its hinges and apply oil to the oil holes and bearings indicated in **Fig. 12**.

To oil the stand, apply a drop of oil to the centers upon which the band wheel and treadle work, and to both ends of the pitman rod connecting the treadle with the band wheel.



Fig. 11

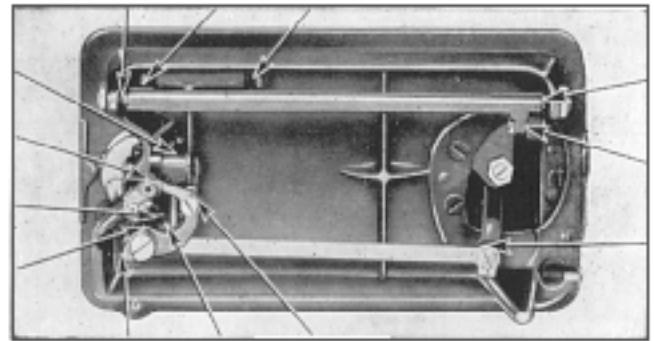

Fig. 12

After oiling, run the machine rapidly for a few minutes so that the oil may reach the bearings. **Neglect to oil the machine will shorten its life and cause you trouble and annoyance.**

Always use SINGER oil. Inferior oil clogs the bearings, prevents efficient working, and causes rapid wear of the mechanism.

SINGER Class 99 & 99K

Needles and Thread

For perfect stitching, thread should be selected according to fabric to be stitched, and needle must be correct size for thread which must pass freely through eye of the needle.

CHART SHOWING THE RELATIONSHIP OF TYPES OF FABRICS, THREAD AND NEEDLE SIZES AND MACHINE STITCHES TO THE INCH

TYPES OF FABRIC	THREAD SIZES	NEEDLE SIZES	MACHINE STITCHES PER INCH	
			<i>Inside Seams</i>	<i>Top Stitching</i>
Very thin Silk, Muslin, Cambric, Light-weight Delicate Fabrics, etc.	100 to 150 Cotton 50 Silk, 80 Mercerised Darning Cotton	9	20	25 to 30
Fine Calicoes, Linens, Shirtings, Fine Silk Goods, etc.	80 to 100 Cotton, 50 Silk, 50 Mercerised Darning Cotton	11	16	20
Plastic Materials	50 to 80 Mercerised Cotton	11	10	12
Shirtings, Sheetings, Bleached Calicoes, Silk and General Domestic Goods, Light Woollen Goods and all classes of general work	60 to 80 Cotton, 50 Silk, 50 Sylko	14	12	18
All kinds of heavy Calicoes, Drill, Woollen Goods, etc.	40 to 60 Cotton	16	10	12
Tickings, Heavy Woollens, Trousers, Boys' Clothing, Corsets, Cloaks, Mantles, Heavy Coats, and Heavy Clothing generally	24 to 40 Cotton, 60 to 80 Linen	18 or 19	8	10
Bags, Coarse Cloths, Canvas, Duck, Heavy Goods of any texture	40 to 60 Linen, or very coarse Cotton	19 or 21	6	8

When ordering needles, always specify Catalogue 2020 (15x1) and state the size and quantity required. You will obtain the best stitching results from your Sewing Machine if it is fitted with a SINGER® Needle.

SINGER Class 99 & 99K

To Set the Needle

Select the correct needle according to the table on **page 11**. Be sure that the needle is not blunt or bent. Raise the needle bar to its highest position and loosen thumb screw **H**, **Fig. 13** in needle clamp. Push needle **with its flat side toward the right** up into needle clamp as far as it will go, then tighten the thumb screw **H**. A screwdriver slot is provided for stronger clamping of needle, required for attachments driven from needle clamp hub.

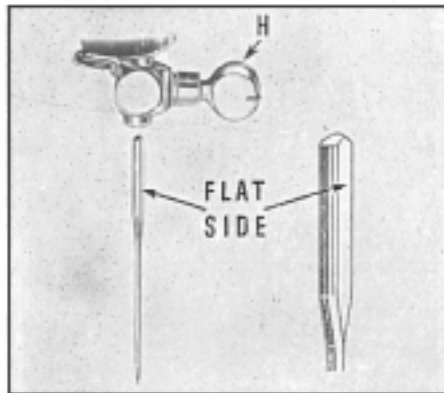

Fig. 13

SINGER Class 99 & 99K

UPPER THREADING

See Fig. 14. Place spool of thread on spool pin. Raise take-up lever **5** to its highest point. Lead thread into thread guide **1**, down and from right to left between tension discs **2**, into the loop of the take-up spring **3**, under the slack thread regulator **4** (**not through the eye in the thread regulator**), up and from right to left through hole in take-up lever **5**, down through guide **6** on the face plate, down through the lower wire guide **7**, from **left to right** through the eye of the needle **8**.

Draw about two inches of thread through the eye of the needle with which to begin to sew.

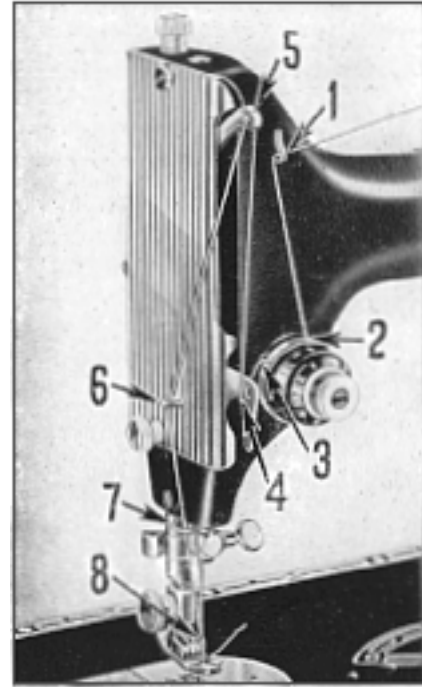

Fig. 14

SINGER

Class 99 & 99K

To Remove the Bobbin

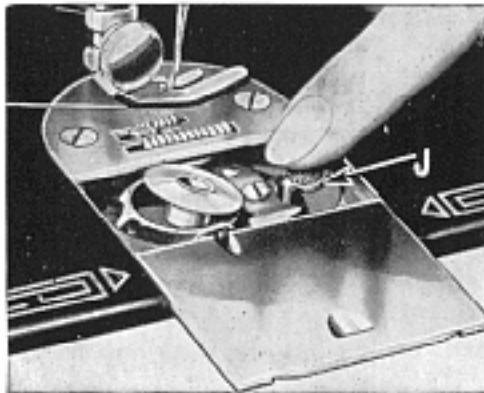

Fig. 15

Raise needle to its highest point. Draw slide plate to the left. Press bobbin ejector **J**, Fig. 15, to raise bobbin for easy removal.

Page 14

[Table of Contents](#) | [Previous Page](#) | [Next Page](#)

SINGER Class 99 & 99K

To Wind the Bobbin

Hold the hand wheel **K**, **Fig. 16**, with left hand and with right hand loosen stop motion screw **L** to disengage stitching mechanism.

Place empty bobbin on bobbin winder spindle, see **Fig. 16**. Turn bobbin until hole in right side engages pin in spindle. Press bobbin winder downward until latch **M**, **Fig. 17**, engages. In this position latch will hold bobbin in place.

Place spool of thread on spool pin **1**.

Draw thread through guide **2** on arm of machine. Lead thread from front to rear through lower notch of guide **3**.

Thread through **O**, **Fig. 17**, in left side of bobbin from inside. The end of the thread must be held by hand until it is broken off by the rotation of the bobbin.

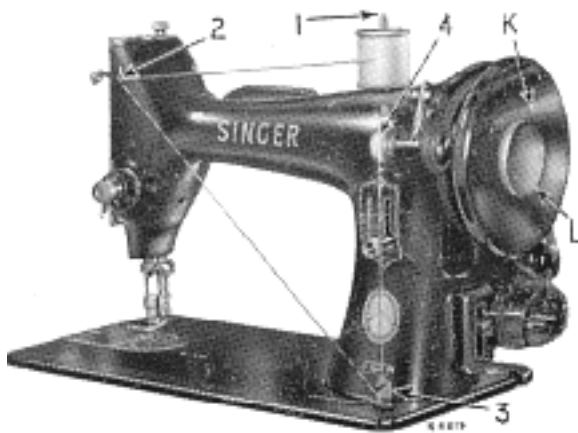

Fig. 16

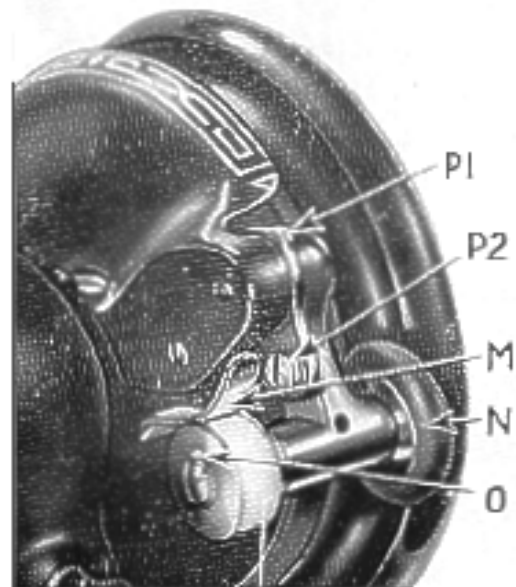

Fig. 17

SINGER Class 99 & 99K

Fig. 17 shows bobbin winder in position for winding. When sufficient thread has been wound the winder is automatically released.

Remove filled bobbin from bobbin winder spindle and re-tighten stop motion screw **L**, **Fig. 16**.

If thread does not wind evenly on bobbin, loosen screw which holds thread guide **3**, **Fig. 16**. Turn guide to left if bobbin winds high on right. Turn guide to left if bobbin winds high on left. When guide is properly centered, thread will wind evenly across bobbin. Tighten guide clamping screw.

If the pressure of bobbin winder pulley **N**, **Fig. 17** against hub of hand wheel is insufficient for winding the bobbin, press down winder until latch **M** drops down and holds it, then loosen screw **P2**. With the forefinger push back upper end of slotted plate **P1** as far as it will go and at the same time, with the thumb, press winder against ledge of wheel. Then tighten screw **P2** securely. Afterwards raise latch to release winder from contact with hand wheel.

Page 16

[Table of Contents](#) | [Previous Page](#) | [Next Page](#)

SINGER

Class 99 &
99K

To Replace the Bobbin

Hold the bobbin between the thumb and forefinger of the left hand, with the thread leading on top from the right toward the left, as shown in **Fig. 18**.

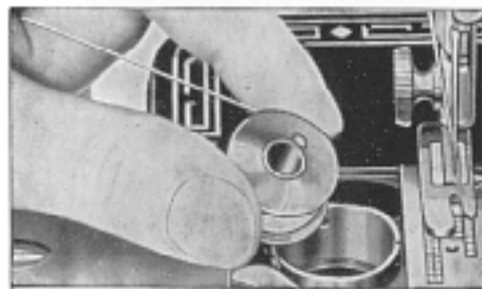

FIG. 18 Replacing the Bobbin

Place bobbin into the bobbin case and draw the thread into the slot **1**, **Fig. 19** in the bobbin case, as shown.

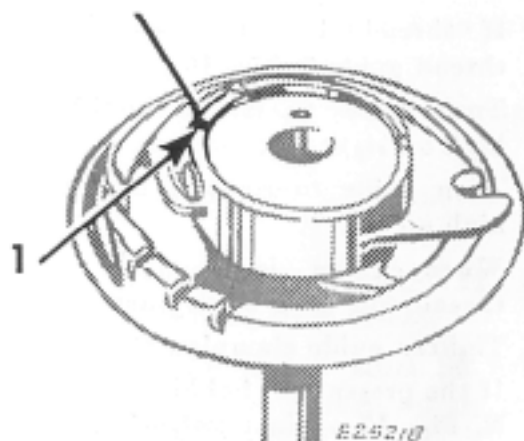

FIG. 19 Threading the Bobbin Case

Draw the thread backward between the bobbin case and the tension spring until it reaches the notch **2**, **Fig. 20**, then pull the thread toward the right as shown in **Fig. 20**.

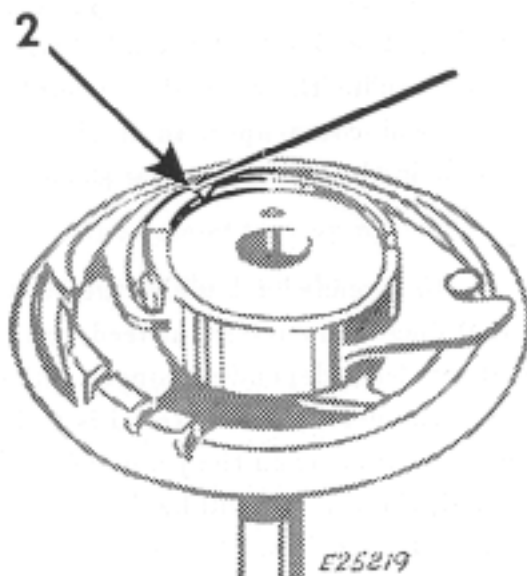

FIG. 20 Bobbin Case Threaded

When closing the slide, place thread up through slot **3**, **Fig. 21** as shown.

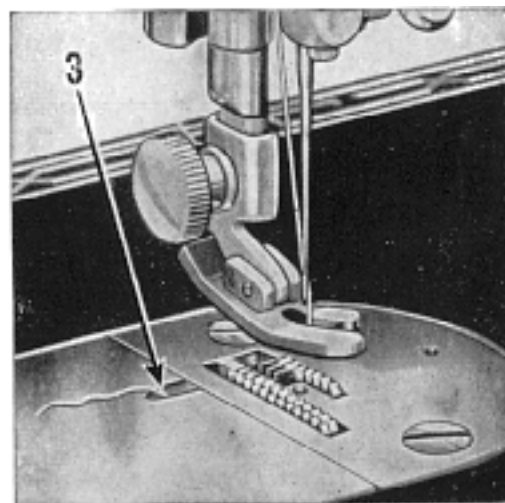

FIG. 21 Under Threading Completed

SINGER

Class 99 & 99K

To Prepare for Sewing

Have the thread take-up lever at its highest position. With the left hand hold the end of the needle thread, leaving it slack from the hand to the needle.

Turn the hand wheel over toward you until the needle moves down and up again to its highest point, thus catching the bobbin thread. Draw up the needle thread and the bobbin thread will come up with it through the hole in the throat plate as shown in **Fig. 22**.

Lay both threads back under the presser foot diagonally across the feed, to right or left, depending upon which side of the needle the material is to be located so that when the presser foot is lowered, the threads will be firmly held between the feed and the presser foot.

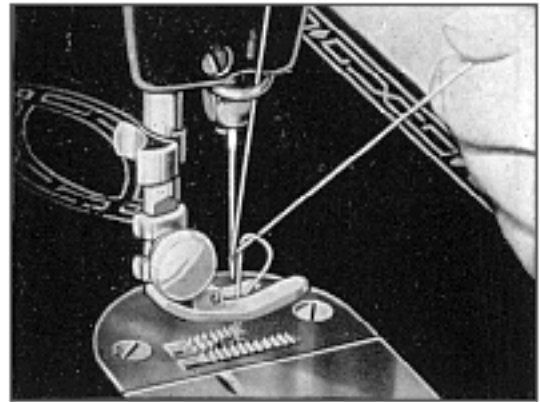

Fig. 22 Drawing Up the Under Thread

SINGER

Class 99 & 99K

To Start Sewing

Be sure to have thread take-up lever **5**, **Fig. 14** at its highest position.

Place the material beneath the presser foot **Q**, **Fig. 23**, then turn the hand wheel to bring the point of the needle into the material, then lower the presser foot by means of presser bar lifter **R** and start to sew.

Some materials, such as soft finished sheers, nylons, jerseys, tricots and other elastic and sponge textiles, require a slight amount of assistance in feeding during sewing operations.

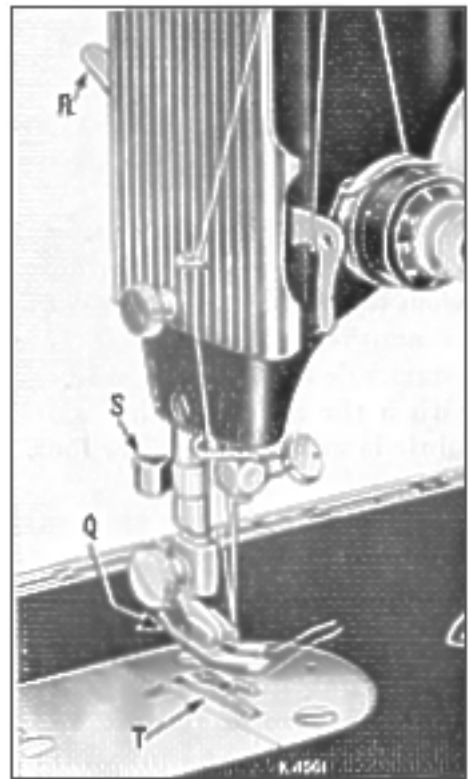

Fig. 23 To Start Sewing

However, too much pull will stretch the seam, create irregular stitching and bend the needle. Most materials require only guiding for best sewing results.

The machine will sew its own thread when sewing from one piece of material to another. However, it is not recommended that any sewing be done with a threaded machine unless some fabric is under the presser foot.

Page 19

[Table of Contents](#) | [Previous Page](#) | [Next Page](#)

SINGER Class 99 & 99K

To Turn a Corner

Stop the machine when the needle eye, making its upward stroke, is still in the fabric. Raise the presser foot and turn the work as desired, using the needle as a pivot, then lower the presser foot and resume sewing.

Basting

The longest stitch, No. 6 on the stitch indicator plate, is satisfactory for basting and is easily removed by clipping every sixth stitch and withdrawing the long continuous thread. Machine basting is firmer, more even and much quicker than hand basting.

To Sew Bias Seams

Use a short stitch when sewing bias or curved seams to increase the elasticity of the seam and to prevent seam failure under strain. No change in tensions is required.

To Remove the Work

Stop the machine with the thread take-up lever **5, Fig. 14** at its highest point. Raise the presser foot by means of presser bar lifter **R, Fig. 23**, draw the fabric back and to the left and sever the threads on thread cutter **S, Fig. 23**. Place ends of threads under presser foot.

Caution: When the machine is not in use, raise the presser foot by means of presser bar lifter **R** to prevent injury to the presser foot and the feed **T, Fig. 23**.

SINGER

Class 99 & 99K

To Regulate Length of Stitch

The machine is adjustable to make from 6 to 30 stitches per inch, as indicated by the numerals on the stitch indicator plate.

The "red dot" indicator **U**, **Fig. 24**, in the slot at the left indicates the stitch setting. To regulate the length of stitch, turn thumb nut **V**, **Fig. 24**, on lever away from the stitch indicator plate as far as necessary. Move the lever at **V** until the "red dot" indicator **U** is at the desired stitch setting. Then turn thumb nut **V** inward until it touches indicator plate. The machine is not set to stitch the desired number of stitches per inch in a forward direction.

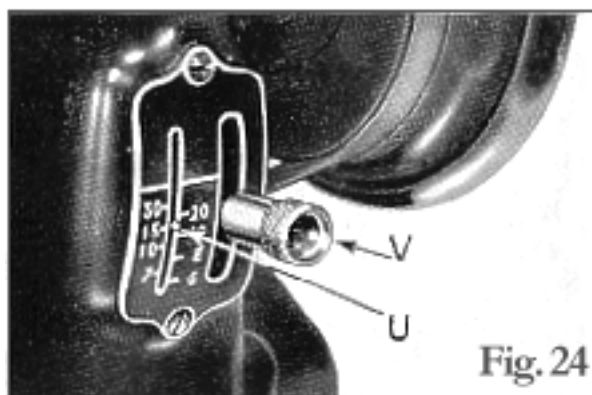

Fig. 24

To Reverse the Direction of Feed

For Back Tacking, raise the lever to the upper end of the indicator plate. The machine will then stitch in a reverse direction, making it easy to fasten the ends of seams.

To Regulate Pressure on Presser Foot

For ordinary sewing, the pressure of the presser foot on the material seldom requires changing. Heavy materials require more pressure than light weight materials. The pressure should be only heavy enough to prevent the material from rising with the needle and to enable the feed to move the work along evenly without side creeping. To increase the pressure, turn the thumb screw **W**, **Fig. 25** clockwise or downward. To lighten the pressure, turn the thumb screw **W** so that it screws upward.

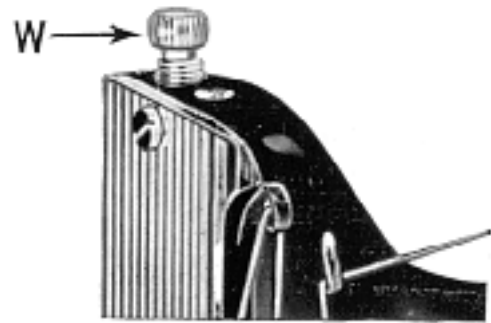

FIG. 25 Thumb Screw for Regulating Pressure on Presser Foot

Thread Tension

For perfect stitching, the tension on the needle and bobbin threads must be heavy enough to pull the threads to the center of the thickness of the material and make a firm stitch, as shown in **Fig 26**. If the needle lies straight along the top side of the material, the tension on the needle thread is too heavy or the tension on the bobbin thread is too light, as shown in **Fig 27**. If the bobbin thread lies straight along the underside of the material, the tension on the needle thread is too light or the tension on the bobbin thread is too heavy, as shown in **Fig. 28**.



FIG. 26 Perfect Stitching



FIG. 27 Imperfect Stitching



FIG. 28 Imperfect Stitching

SINGER

Class 99 & 99K

To Regulate Needle Thread Tension

The tension on the needle thread can be tested only when the presser foot is down.

The numerals "0" to "9" dial **X**, **Fig. 29** indicate the different degrees of tension that can be obtained. The numbers do **not** denote size of thread or amount of tension.

When the tension has been correctly set, note the number at the indicator line **Y**, **Fig. 29** so that this setting may be regained should the tension be altered for special work.

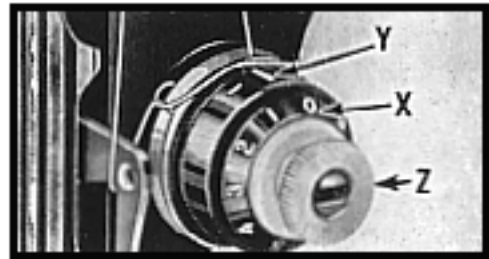

Fig. 29 To Regulate Needle Thread Tension
To increase tension, turn the thumb nut **Z**, **Fig. 29** gradually to the right (clockwise) until the required tension is obtained. Each higher number denotes increased tension.

SINGER

Class 99 & 99K

To Regulate Bobbin Thread Tension

The tension on the bobbin thread is regulated by the screw **A**, **Fig. 30** which is nearest the center of the tension spring on the outside of the bobbin case. To increase the tension, turn screw **A** over to the right. To decrease the tension, turn this screw to the left.

When the tension on the bobbin thread has been once properly adjusted, it is seldom necessary to change it. A correct stitch can usually be obtained by varying the tension on the needle thread.

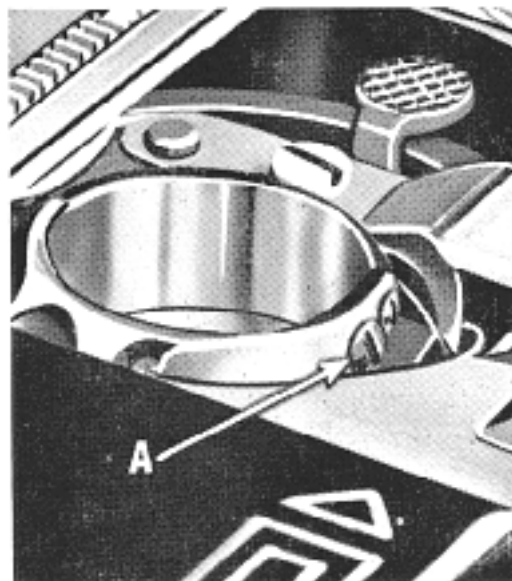

Fig. 30 Bobbin Thread Tension

SINGER Class 99 & 99K

To Adjust the Needle Thread Tension

Lower the presser bar and turn the numbered dial **X** to bring the numeral "1" opposite the center line **Y**, **Fig. 29** between the plus and minus signs on the tension indicator. Press the numbered dial inward as far as it will go, and turn the thumb nut **Z** until the pin engages one of the holes in the numbered dial. Turn the thumb nut, together with the numbered dial, to the left. This should cause "0" to stop opposite the center line if the tension is properly assembled. Now insert the pin of the thumb nut **Z** in different holes of the numbered dial until one is found which gives a **slight perceptible tension** on No. 50 mercerised thread when the thumb nut is turned to the extreme left and the numeral "0" is opposite the center line. This tension gradually increases with the turn of the thumb nut to the right, providing a full range of tensions from light to heavy with one revolution of the thumb nut.

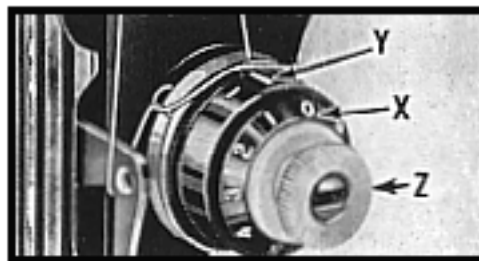

Fig. 29 To Regulate Needle Thread Tension

To Adjust the Tension on the Thread Take-up Spring

The tension on the thread take-up spring should be just sufficient to take up the slack of the needle thread until the eye of the needle in its descent reaches the material.

To Adjust the Bobbin Thread Tension

First adjust the needle thread tension, as instructed above. Then, using No. 50 mercerised thread in both the needle and the bobbin, and using two thicknesses of thin material under the presser foot, turn the numbered dial by means of the thumb nut, to bring the numeral "4" opposite the center

SINGER Class 99 & 99K

line. A few stitches should now be made in the material and then examined to see if the stitch is properly locked in the material. If the bobbin thread shows on top, the tension on the bobbin thread should be increased. If the needle thread shows on the bottom, the tension on the bobbin thread should be decreased. A wide range material and threads can now be accommodated without further adjustment of the bobbin thread tension.

Any change in tension, required to obtain a proper stitch to suit different materials being sewn, can be made by a slight adjustment of the tension on the needle thread only.

To Clean the Stitch Forming Mechanism

After considerable use, the stitch forming mechanism of the machine may become clogged with lint and this may interfere with the perfect operation of the machine. Occasionally remove the bobbin case from the machine, according to the following instructions, and remove any lint, etc., which has accumulated in the machine.

To Remove the Bobbin Case

Operator Being at the Front of the Machine.

Raise the needle to its highest position by turning the hand wheel over toward you. Draw the slide plate **AA**, **Fig. 31** slightly to the left, then lift its right hand end and draw it toward the needle until it is disengaged from the spring **BB** in the bed of the machine.

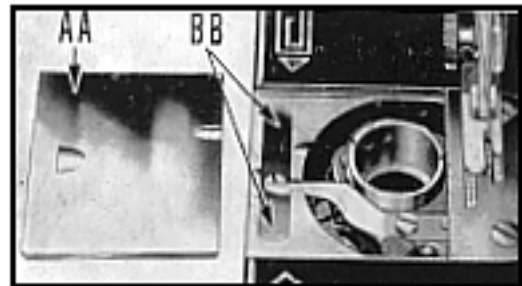

Fig. 31 Slide Plate Removed

SINGER Class 99 & 99K

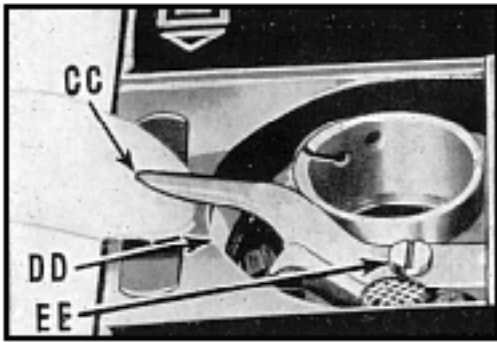

Fig. 32 Raising the Bobbin Case Latch

Insert the forefinger of the left hand under the latch **CC**, **Fig. 32**, raise the latch just high enough to clear the edge **DD** and then move the latch toward you.

Under no circumstances must the screw EE be loosened. The loosening of this screw will change the clearance for the thread between the bobbin case and the bobbin position bracket.

Page 27

[Table of Contents](#) | [Previous Page](#) | [Next Page](#)

SINGER

Class 99 & 99K

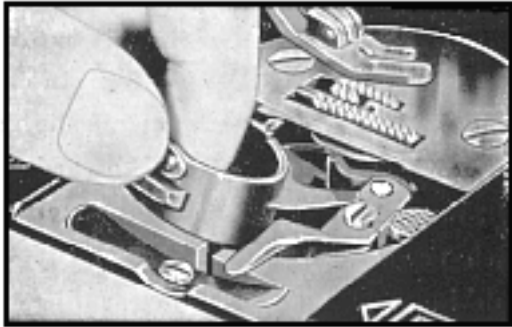

Fig. 33 Removing the Bobbin Case

Hold the bobbin case between the forefinger and the thumb of the left hand as shown in **Fig. 33**. Tilt the bobbin case to the left and at the same time slightly turn the right or forked end toward you so that it is moved out of engagement with the sewing hook. Then tilt the bobbin case toward the right and remove it.

To Replace Bobbin Case

Operator Being at the Front of the Machine.

See that the needle is raised to its highest position and that the latch **CC**, **Fig. 34** is raised from the slot **FF**, **Fig. 34** and moved toward you

Hold the bobbin case between the forefinger and thumb of the left hand, as shown in **Fig. 33**. Insert the forked end of the bobbin case under the throat plate so that the fork straddles the end of the bobbin case position bracket **GG**, **Fig. 34**. Then, with a slight twisting motion of the bobbin case to the left and to the back, lightly press it downward

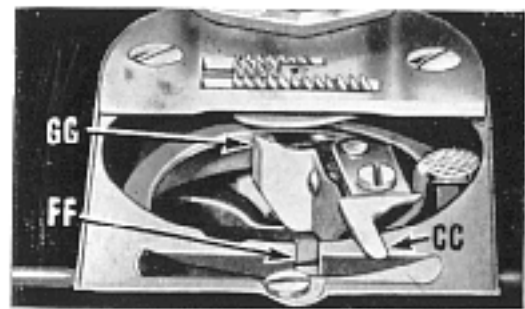

Fig. 34 Bobbin Case Position Bracket until the edge of the sewing hook engages in the groove under the rim of the bobbin case.

Having set the bobbin case into the correct position, lock the latch **CC**, **Fig. 34** in the notch **FF**, **Fig. 34** to hold the bobbin case in place.

SINGER Class 99 & 99K

To Replace Slide Plate

Replace the slide plate from the right, as shown in **Fig. 35**, being careful to see that the two ends of the spring **BB** enter the grooves on the underside of the slide plate.

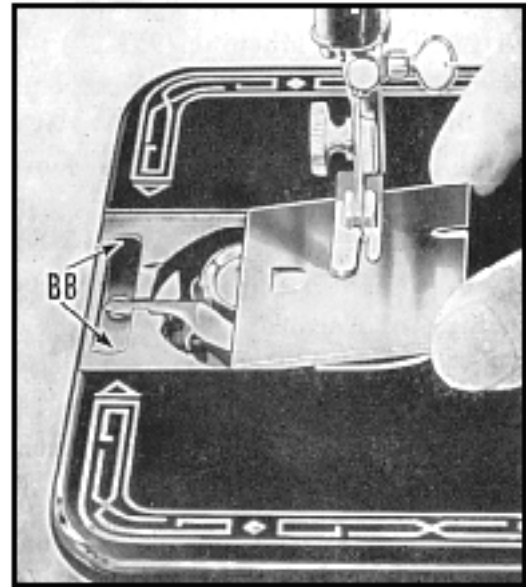

Fig. 35 Replacing Slide Plate

SEWING SUGGESTIONS

Belt for Treadle Machine (99K29)

The **Belt** should be only just tight enough not to slip. If too loose, shorten and rejoin.

Breaking of Needles Might be Caused by:

1. Improper size of needle for thread and material -- see **page 11**.
2. Bent needle.
3. Pulling material when stitching.
4. Needle striking an improperly fastened presser foot.
5. Crossing too thick seams with too small a needle.

SINGER Class 99 & 99K

Breaking of Needle Thread Might be Caused by:

1. A knot in thread.
2. Improper threading -- see **page 13**.
3. Upper tension is too tight -- see **pages 22 - 23**.
4. Needle not pushed up as far as it will go into needle clamp -- see **page 12**.
5. Needle blunt or bent.
6. Thread too coarse for needle -- see **page 11**.
7. Roughened hole in throat plate.
8. Improper arrangement of threads to start sewing -- see **page 18**.

Breaking of Bobbin Thread Might be Caused by:

1. Improper threading of bobbin case -- see **pages 17 - 18**.
2. Bobbin thread tension too tight -- see **pages 22 - 23**.

Skipping of Stitches Might be Caused by:

1. Needle not pushed up as far as it will go into needle clamp -- see **page 12**.
2. Needle blunt or bent.
3. Needle too small for thread -- see **page 11**.

If machine runs heavily after standing idle for a long period, apply a few drops of paraffin at all oiling places, run machine for a few minutes, then wipe clean and oil the machine -- see **pages 9 - 10**.

SINGER Class 99 & 99K

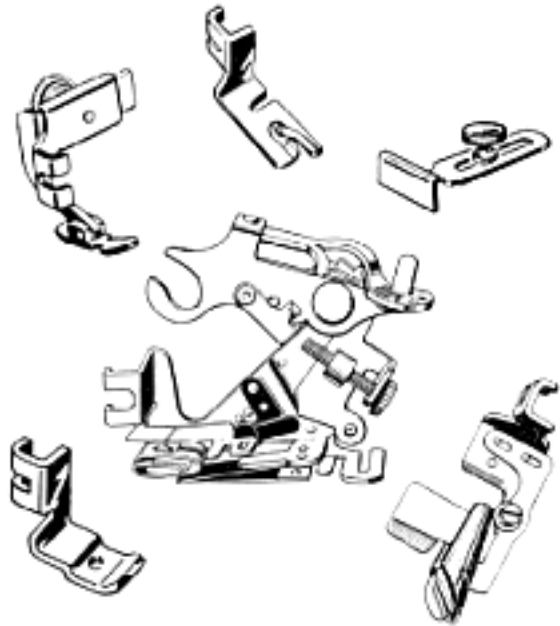

Page 31

[Table of Contents](#) | [Previous Page](#) | [Next Page](#)

SINGER

Class 99 & 99K

THE FOOT HEMMER

The foot hemmer forms and stitches a perfectly turned hem without basting or pressing. It is attached to the machine in place of the presser foot.

Applications

Fine hems
Edging ruffles
Sheer seams
Hemming with Lace
Lace insertion
Lingerie finishes

Hemming

- Form a double 1/8" fold at the very edge of the fabric.
- Crease this fold for about 2".
- Draw the needle and bobbin threads under the hemmer.
- Place the creased hem edge under the foot and take several stitches through the fold.
- Grasp the thread ends and the single fold in front of the hemmer and lift the single fold into the hemmer scroll.

Soft fabrics will enter the scroll best with the foot down, firm crisp fabrics with the foot raised.

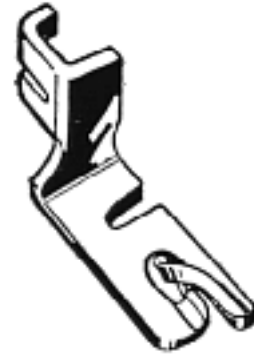

The Foot Hemmer

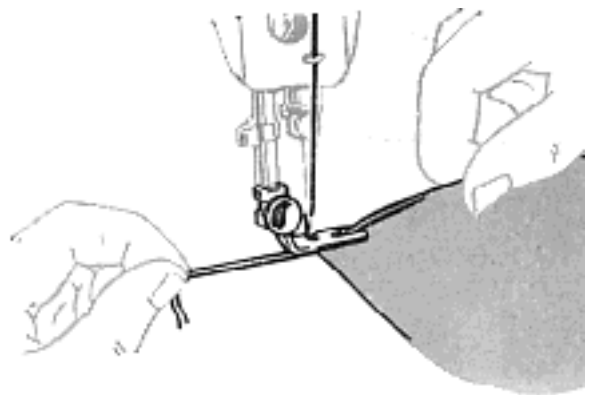

SINGER

Class 99 & 99K

Hemming (cont')

- Stitch slowly for several inches until hem is well started. Hold thread ends in back of foot with the left hand and guide the raw fabric edge into the mouth of the scroll with the right hand.

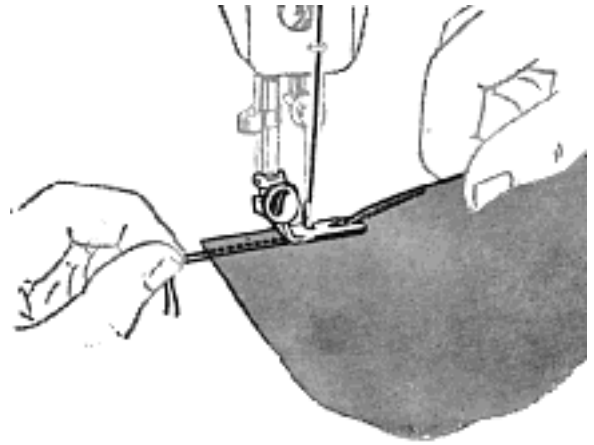

Even feeding is essential to good hemming. The same width of fabric must be kept in the scroll of the hemmer at all times.

Hemmed Seams

Hemmed seams are often substituted for French seams where a fine narrow seam is appropriate.

- Allow a scant 1/4" seam allowance.
- With right sides of the fabric together, place the upper layer a scant 1/8" to the left of the lower layer.,
- Insert the two fabric edges into the hemmer and proceed as for a plain hem.

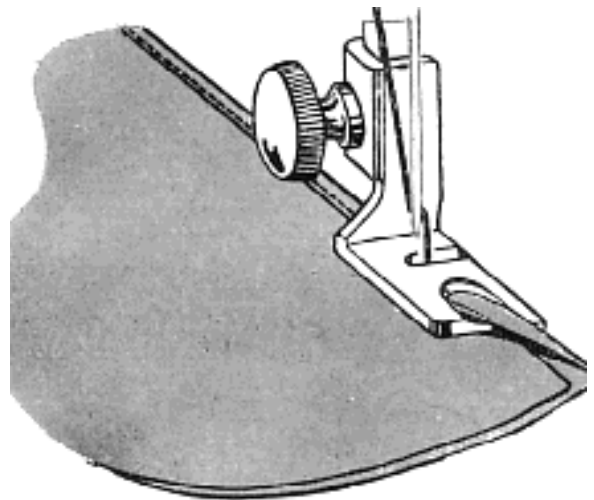

SINGER

Class 99 & 99K

Hemming with Lace

Most of the popular kinds of lace edging and insertion can be applied with the foot hemmer. It is an excellent way to trim children's clothes and to finish lingerie hems.

Lace Applied over Hem

- Fold and start hem in usual way.
- Starting about 1 inch down from end of lace, place selvage under the needle, the lower the needle to hold lace firmly.
- Raise hemmer foot slightly and slip lace under back part of foot.
- Stitch slowly, guiding fabric with right hand and lace with left hand. Take care not to stretch the lace.

Lace Applied under Hem

When using lace underneath the fold of a hem, the procedure is the same as when making a hemmed seam (page 33). Slip the lace in from the left as you would the second piece of fabric. This method is used where a neat finish is desired on both sides of the material.

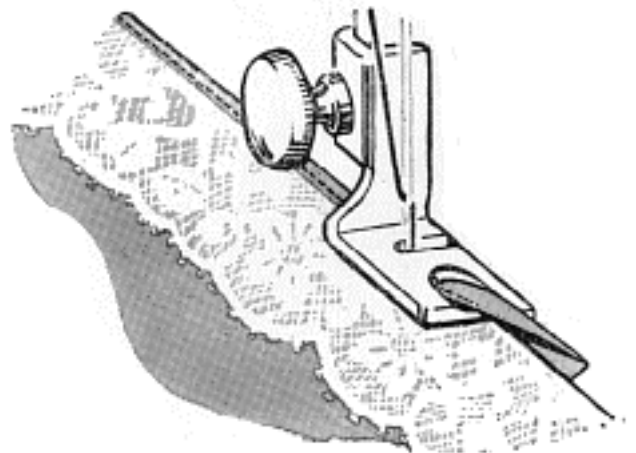
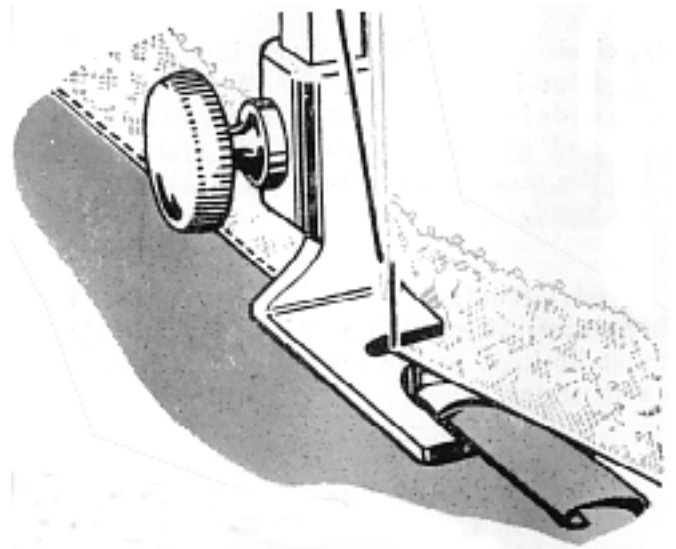

THE BINDER

The binder is used to apply commercial binding as well as self-fabric bias to an unfinished edge.

This colorful trim is attractive when applied to children's wear, aprons and fabric furnishings. It is a practical finish for seam edges that ravel and for making bound seams.

Inserting the Binding

Pre-folded commercial bias binding is inserted from the right into the outside slot of the binder scroll.

- Cut the binding diagonally to form a long point.
- Insert the pointed end into the slot and pull through the scroll until the evenly folded edges are under the needle. Self-fabric bias binding should be cut $15/16$ " wide on the true bias.
- Insert the unfolded binding directly into the two folds at the end of the scroll and draw it back under the needle. As the binding passes through the scroll the raw edges are turned in.

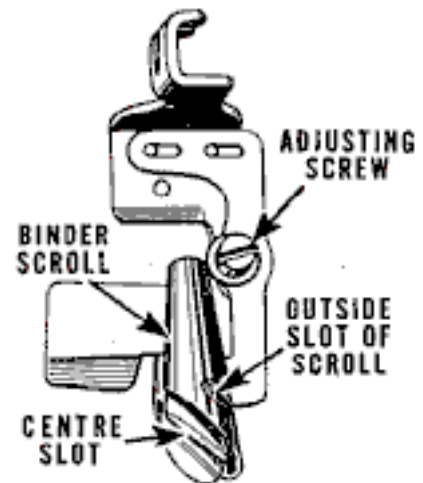

The Binder

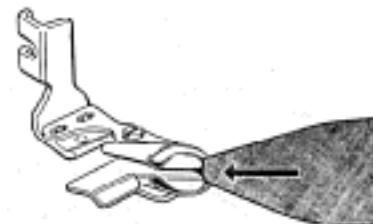
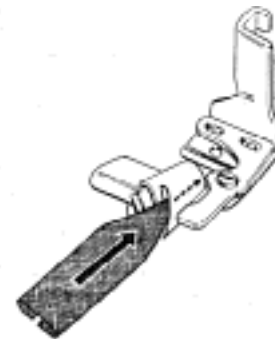

SINGER

Class 99 & 99K

Adjustment and Operation of the Binder

The edge to be bound is guided into the center of the scroll. Stitching is positioned close to the edge of the binding by adjusting the scroll portion of the attachment.

- Loosen the adjusting screw and move the scroll to the right to bring the stitching closer to the binding edge. For a wider adjustment, move the scroll to the left.

Be sure that the screw is well tightened after making an adjustment.

Never pull the binding as it feeds through the scroll. Allow the attachment to do the work. Merely guide the edge to be bound well into the center of the scroll as you stitch.

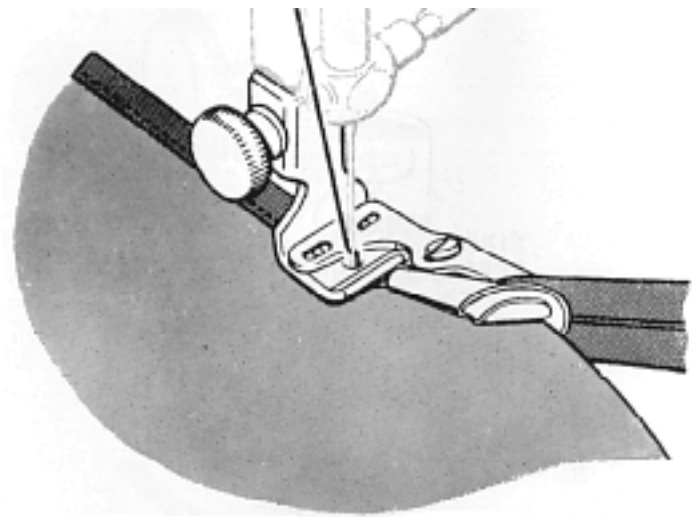
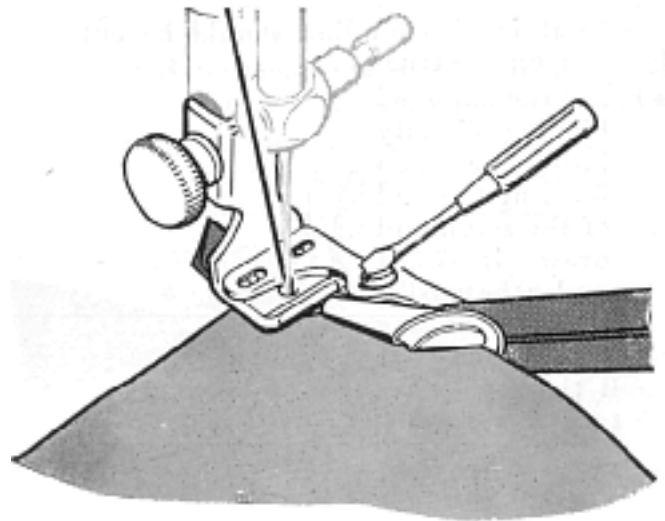

SINGER

Class 99 & 99K

Binding Curved Edges

Curved edges can be bound as easily as straight edges, but require slightly different fabric handling.

Inside Curves

Inside curves are straightened as they are fed into the binder. If the fabric is soft and has a tendency to stretch, reinforce the edge with a single row of stitching before binding.

Outside Curves

Outside curves tend to lead away from the center slot of the scroll and should be guided so that a full seam width is taken at the needle point. Do not attempt to pull or straighten the fabric into the full length of the scroll.

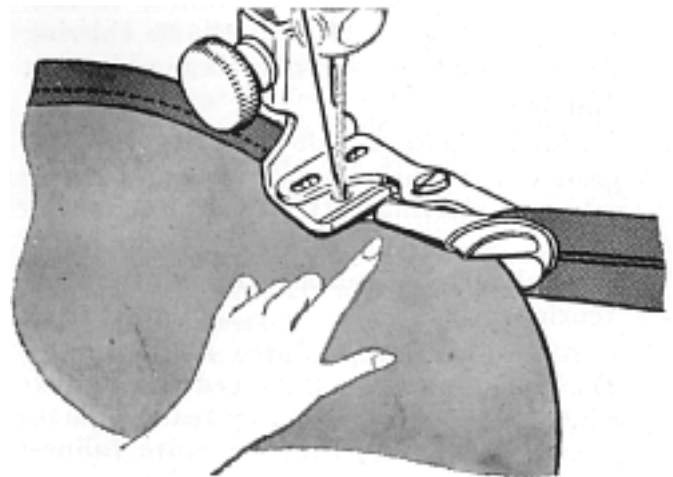
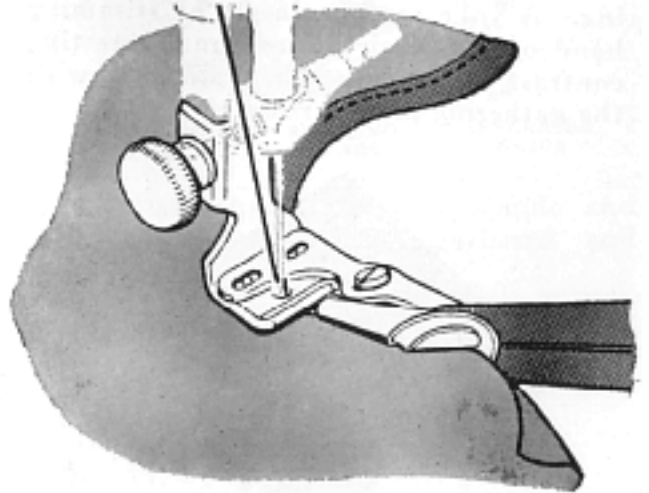

SINGER

Class 99 & 99K

THE GATHERING FOOT

Single or multiple rows of shirring can be quickly and expertly placed with the gathering foot. Evenly spaced shirring is insured as this foot is designed to lock fullness into every stitch.



The Gathering Foot

Applications

- Plain shirring
- Elastic shirring
- Waffle shirring
- Machine smocking

Shirring

Shirring is usually done on the crosswise grain of the fabric. Soft fabrics lend themselves to shirring better than firm fabrics.

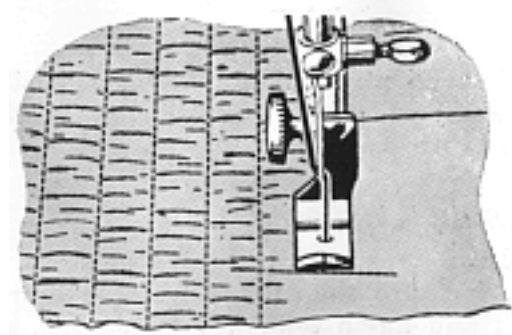

The amount of fullness is very simply controlled by stitch length and degree of tension.

A long stitch produces more fullness than a short stitch. Balanced tensions are always required, but heavy tensions, both upper and lower, produce more fullness than light tensions.

Many lovely effects are accomplished with simple rows of evenly spaced shirring. A yoke section, insert or trimming band of self-fabric affords an interesting contrast of texture when stitched with the gathering foot in rows 1/4" apart.

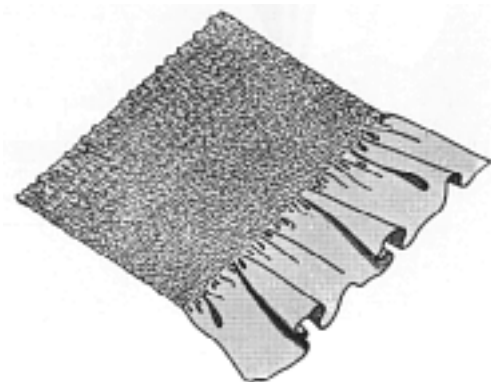

SINGER

Class 99 & 99K

THE RUFFLER

Occasionally apply a drop of oil to parts in movable contact.

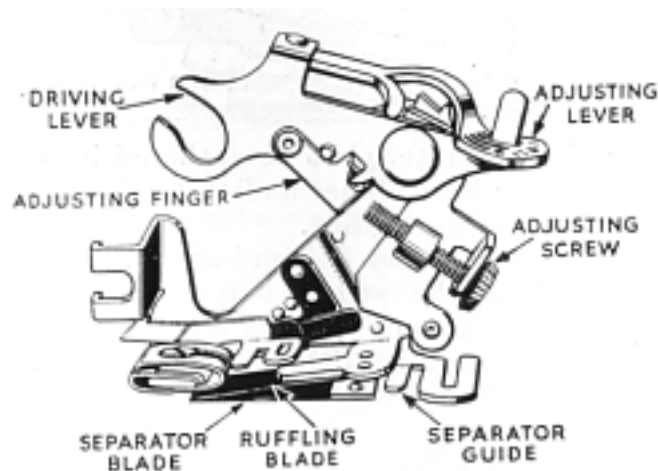

This attachment offers a simple and effective way to make gathered and pleated ruffles.

Ruffles may be made separately or made and applied at the same time.

The ruffler is attached to the machine in place of the presser foot.

Adjusting Points

- 1. The adjusting lever sets the ruffler for gathers or pleats.** The number 1 space setting is for gathers, and places fullness at every stitch. Numbers 6 and 12 are space settings for pleats, spacing them either 6 or 12 inches apart. The star is for plain stitching, and is used when grouping gathers or pleats.
- 2. The adjusting finger is used only for pleating and affects the width of the pleat.** It is thrown out of action by bringing it out of contact with the adjusting screw located at the right of the ruffler.

SINGER

Class 99 & 99K

3. The adjusting screw regulates the fullness of gathers or pleats. When turned in (clockwise) to its limit with the adjusting finger in place, the attachment is set for its deepest pleat. When turned out (counter-clockwise) to its limit and the adjusting finger out of action, the ruffler gives only a hint of fullness.

Activating Parts

The ruffling blade and the separator blade are of blue steel and hold the material to be gathered between them. **The ruffling blade** forms the gathers or pleats by carrying the fabric to the needle according to the spacing and fullness to which the ruffler is adjusted. **The separator guide** is slotted to guide seam edges evenly and to separate the ruffle strip from the material to which the ruffle is attached.

Preparation

Raise the needle to its highest point. Locate the attachment on the machine in place of the regular presser foot, and at the same time fit the fork of the driving lever over the needle clamp screw. Make sure both the presser bar screw and the needle clamp screw are tightened securely.

Gathering

- Set adjusting lever on No. 1 setting.
- Throw adjusting finger out of action.
- Turn adjusting screw for amount of fullness desired.

The attachment is set for maximum fullness by turning adjusting screw in (clockwise) as far as possible; for less fullness, turn adjusting screw out (counter-clockwise).

SINGER

Class 99 & 99K

Gathering (cont')

- Set stitch length to space the fullness. A short stitch gives more fullness than a long stitch.
- Insert material to be gathered between the blue blades and through the first separator guide.
- Lower presser bar and stitch. Always test the stitch length and ruffler setting on a scrap of self fabric before proceeding with the actual work.

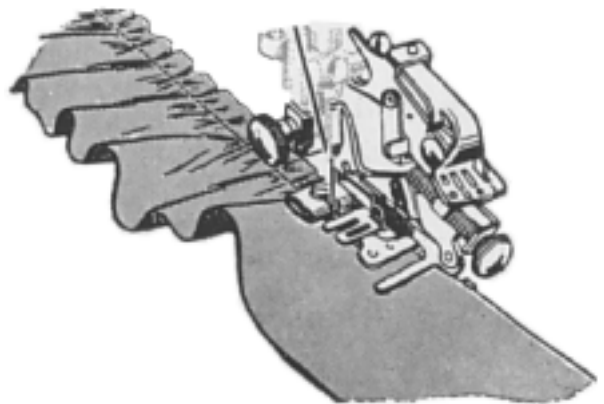

Forming and Attaching a Ruffle in One Operation:

- Place ruffle strip between the two blue blades and through the first separator guide.
- Place fabric to which ruffle is to be attached between the separator blade and the feed of the machine. Right sides of the fabric are placed together when the seam is to fall to the side.
- Proceed as for plain gathering.

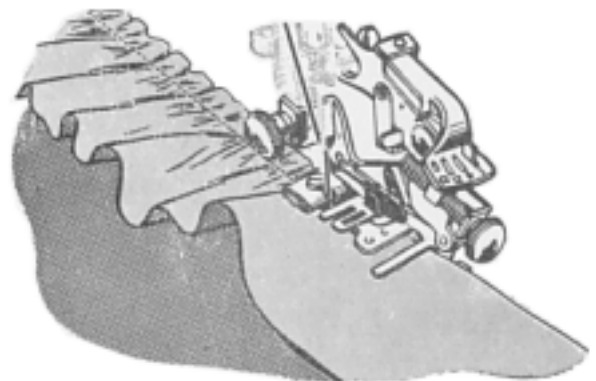

SINGER

Class 99 & 99K

Pleating

- Move adjusting lever to space setting desired for pleats of either 6 or 12 stitches apart.
- Activate adjusting finger.
- For deepest pleat, turn adjusting screw in (clockwise) to its maximum. For shallower pleats, turn adjusting screw out (counter-clockwise).
- Set stitch length. A short stitch places pleats close together. A longer stitch separates the pleats for a greater distance.
- Insert fabric to be pleated between the blue blades and through the separator guide.
- Lower presser bar and stitch.

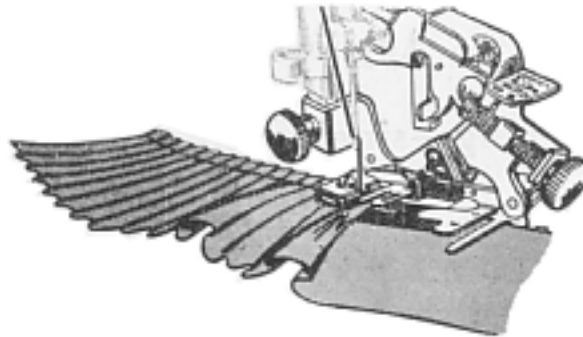

Group Pleating

By using the star setting (plain stitching) alternately with the 6 or 12 setting, pleats are formed in groups. Even spacing between groups is easily accomplished by counting the number of stitches.

Page 42

[Table of Contents](#) | [Previous Page](#) | [Next Page](#)

SINGER

Class 99 & 99K

THE SEAM GUIDE

The seam guide is adjustable for spacing stitching at any distance between 1/8" and 1-3/8" from a fabric edge. It is used in connections with the presser foot.

Applications

Seams

Stay stitching
Top stitching - single and multiple rows

- Attach the guide to the machine with the thumb screw in either of the threaded holes at the right of the needle.
- Adjust for width desired.
- For straight edges, align guide with the presser foot.
- For curved edges, set the guide at an angle so that the end closest to the needle acts as a guide.
- For pinned seams, place the pins with the points toward the seam edge so that they nip into the fabric at the stitching line. The hinged foot will then ride freely over the points.



The Seam Guide

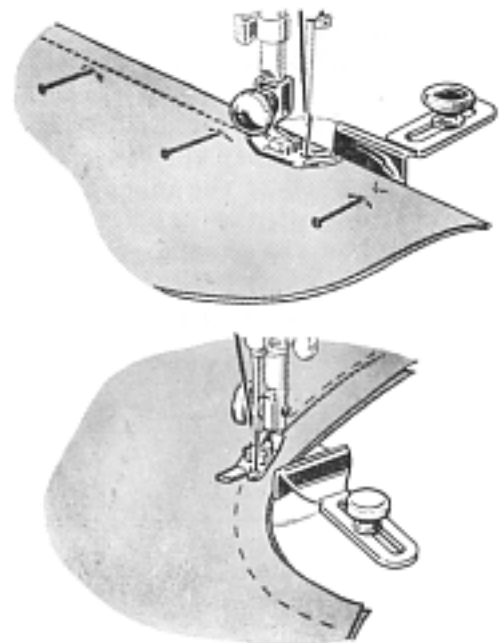

THE ZIPPER FOOT

The zipper foot is designed for accurate placement of stitches close to a raised edge. The hinged feature of this foot insures even feeding over pins, heavy layers of fabric or cross seams. It is attached to the machine in place of the presser foot, and may be adjusted to either side of the needle.

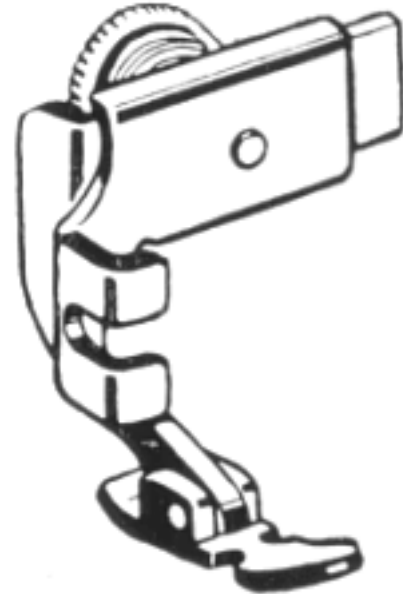

The Zipper Foot

Applications

Zipper insertions
Corded seams
Tubular cording
Slip cover welting

Preparation

- Attach zipper foot to machine in place of presser foot.
- Loosen zipper foot thumb screw and adjust foot to right or left of needle, as desired.
- Align the notch in the toe with the needle hole in the throat plate.
- Check adjustment by lowering needle into side notch, making sure it clears the foot.
- Lock foot in position by tightening thumb screw.

SINGER

Class 99 & 99K

Skirt Zipper

- Machine baste placket opening of skirt and press this seam open.
- Attach zipper foot to machine in place of presser foot.
- Position zipper foot to right of needle.
- Open zipper.
- Place zipper face down on seam allowance with edge of teeth at seam line.
- Turn the back seam allowance away from body of skirt.
- Move foot to the left of needle.
- Close zipper and turn it face up.
- Smooth back the seam allowance at the edge of the zipper.
- Top stitch the seam allowance to the tape close to the folded edge.

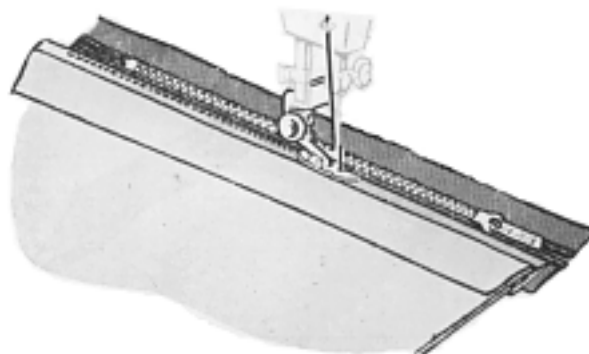
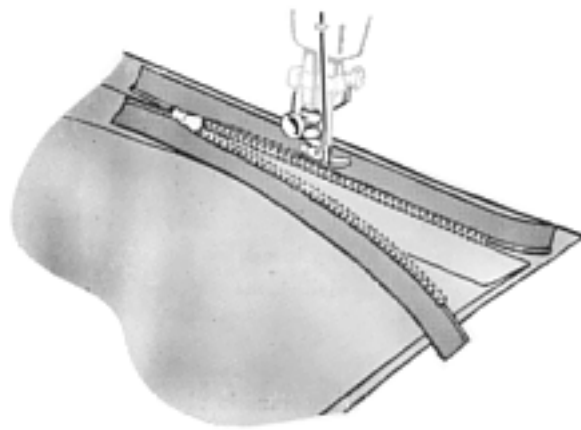

SINGER

Class 99 & 99K

Skirt Zipper (cont')

- Turn skirt to right side.
- Fold zipper to front of skirt.
- Pin in place from right side.
- Baste.
- Move foot from right side.
- Stitch across lower end of zipper and up to waistline.
- Remove basting.

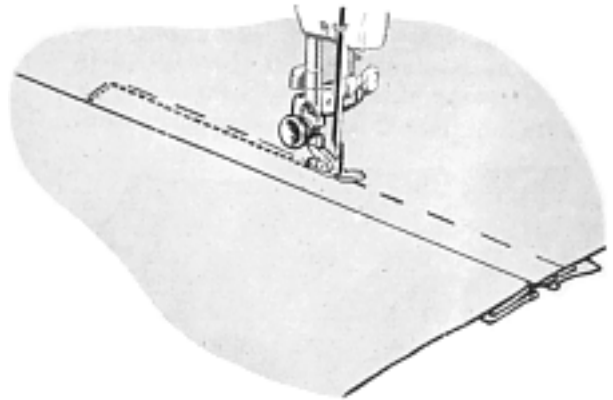

Corded Welting

Cable cord comes in a variety of sizes and when covered with a firmly woven fabric makes a corded welting that is an excellent seam finish.

This welting is prepared in advance and then stitched into the seam. Cut a true bias strip $1\frac{1}{4}$ inches wide, plus three times the width of the cord of either self or contrasting fabric. Sew strips together on the lengthwise grain to obtain desired length.

- Adjust zipper foot to left side of needle.
- Encase cord in bias strip, raw edges even.
- Lower presser bar.
- Stitch close to cord, using a stitch length slightly longer than for plain seaming of same fabric.
- Do not crowd stitching against cord.

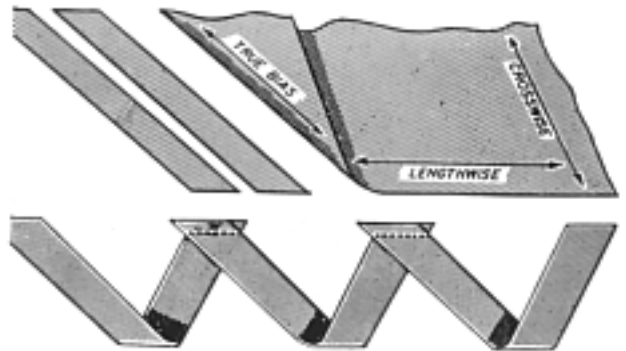

SINGER

Class 99 & 99K

Corded Seams

The corded seam is a typical treatment for slip covers, children's clothes, blouses and lingerie.

When cording a seam the zipper foot is usually adjusted to the right of the needle so that the bulk of the work will fall to the left.

- Attach corded welting to right side of a single seam edge, using same length stitch as used for welting (page 46). Guide edge of foot next to cord but **do not crowd**.
- Place attached corded welting over second seam edge, and pin or baste together.
- Keep the first stitching uppermost as a guide and position the seam under the needle.
- Stitch, this time crowding the foot against the cord.

This method produces evenly joined seam edges and tightly set welting.

Curved seams are corded as easily as straight seams, except that a shorter stitch is used. Since the seam allowance of the welting is bias, it is easy to same it to the seam.

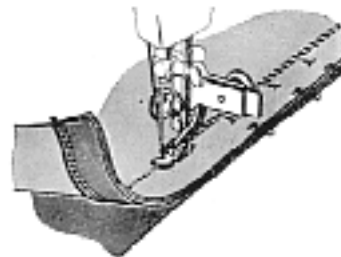
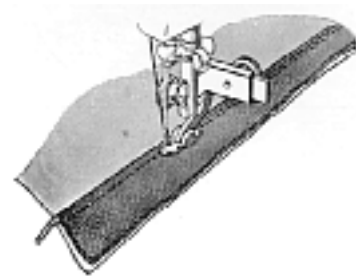
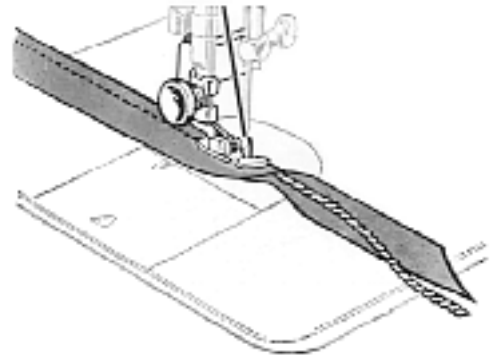

SINGER

Class 99 & 99K

FASHION AIDS

...available for separate purchase at your local Singer Sewing Center.

THE BUTTONHOLER

This attachment produces neat and durable buttonholes in a great variety of fabrics without any special skill on the part of the operator. The buttonholes are produced in a fraction of the time required for hand work and they are firmer and more even than those made by hand.

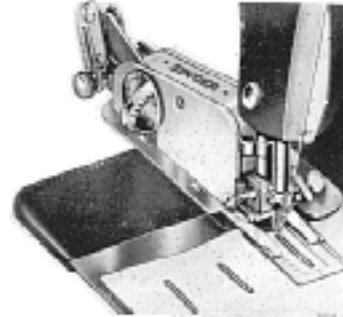

THE BLIND STITCHER

This useful **SINGER** attachment produces invisible hemming with perfect blind stitches on an almost unlimited variety of work such as skirts, dresses, lingerie, children's clothes, towels, curtains, sheets, table cloths and many other articles.

It is quickly attached to your sewing machine in place of the presser foot. It is easy to use and will enable you to accomplish superior invisible hemming much faster and with less effort than is possible by hand.

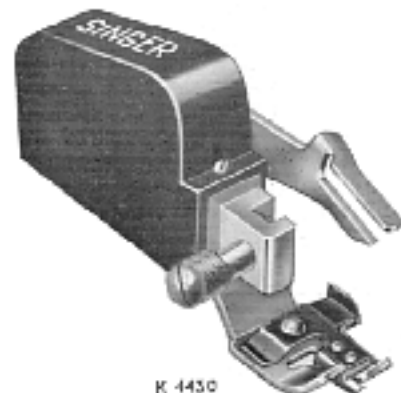
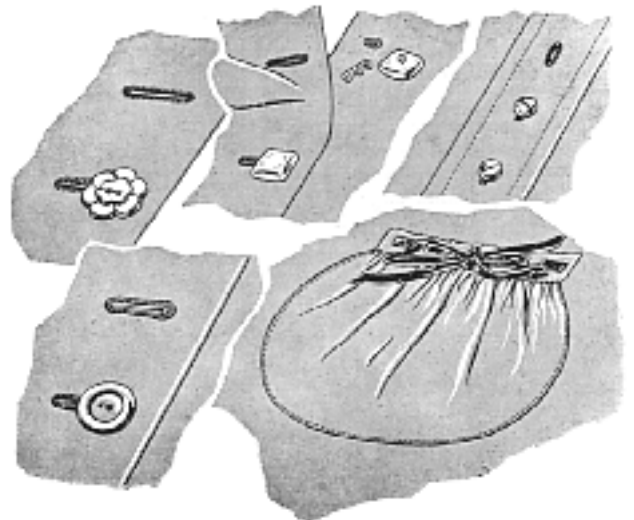

SINGER

Class 99 & 99K

THE BIAS GAUGE

The Bias Gauge is very useful (especially in the case of soft materials) when cutting bias strips from $\frac{7}{16}$ inch to $1\frac{3}{8}$ inches in width. This is done by placing the bias gauge upon the point of the scissors and setting the blued indicator to the width desired. The line **F** is the point at which to set the blued indicator for facings, the line **B** for bindings, and the line **C** for cording or piping.

Insert The material in the gauge with the edge against the blued indicator, and hold as shown at right.

Bias binding should be cut $\frac{15}{16}$ inch wide, and to do this the indicator should be set midway between the lines **F** and **B**.

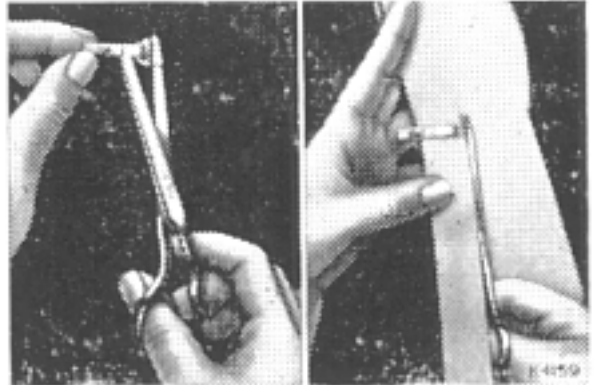

SINGER

Class 99 & 99K

THE EDGE-STITCHER

The edge-stitcher provides a series of slotted guides which regulate the placement of stitches in relations to a fabric edge.

It is attached to the machine in place of the presser foot.

Applications

Joining lace and insertion
French seams
Tucking with lace
Straight and pin tucks
Facing and seam finishes
Seam piping

Joining Lace and Insertion

Lovely lingerie detail is simple to accomplish with the edge-stitcher by joining lace insertions or alternate bands of fabric and lace. Slots **1** and **4** are used for this work. Since slot **1** overlaps slot **4**, the edge insertion into slot **1** will be the top stitched edge.

- Place the first band (the fabric band where used) into slot **1**.
- Adjust lug **A** to position the stitching close to the edge of this band.

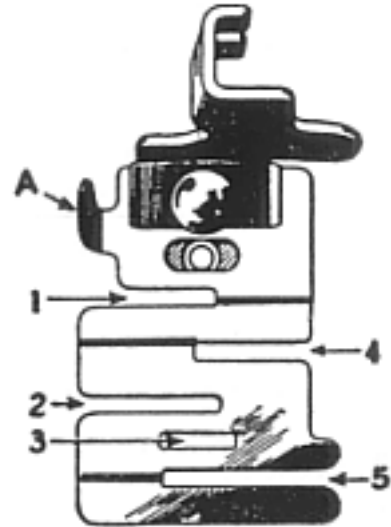

SINGER

Class 99 & 99K

Joining Lace and Insertion (cont')

- Place the second band (lace) into slot 4.
- Adjust pressure to correct degree of lightness for even feeding.
- Use a short stitch length and balanced tensions.
- Hold both band edges against the end of the slots while stitching.

French Seams

The edge-stitcher makes very fine French seams, so well adapted to sheer fabrics where raw seam edges must be concealed.

- Trim away seam allowances to $\frac{1}{4}$ ".
- Lay seam edges together, right sides of fabric outward, and insert into slot 1.
- Move lug **A** to the left to position stitching $\frac{1}{8}$ " from the edge.
- Stitch and press.
- Fold with right sides of fabric together and insert into slot 1.
- Move lug **A** to extreme left, allowing just enough margin to conceal raw edges.
- Stitch.

Tucking

Dainty tucks from "pin" width to $\frac{1}{4}$ " may be produced with the edge-stitcher. Tucks are usually made on the lengthwise grain of the fabric.

- Draw a single thread from the fabric, or measure from the selvage to locate the first tuck on the straight of the fabric grain.

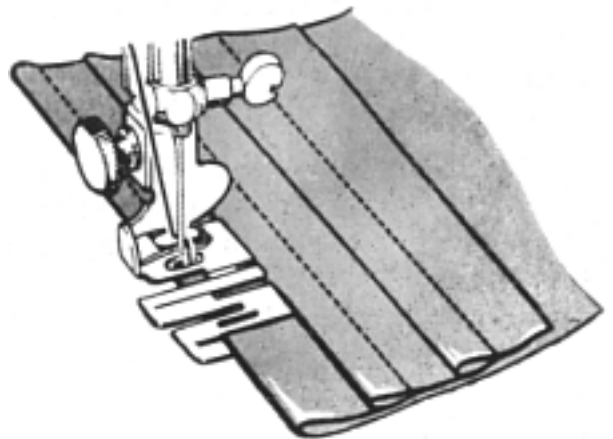

SINGER

Class 99 & 99K

Tucking (cont')

- Draw a single thread from the fabric, or measure from the selvage to locate the first tuck on the straight of the fabric grain.
- For succeeding tucks, crease fabric or draw a thread at distance desired from previous tuck.
- Press tuck folds before stitching.
- To make "pin" tucks, insert the tuck fold in slot **1** and adjust lug **A** to locate stitching a pin width from the fold.
- To make 1/4" tucks, insert the tuck fold into slot **5**, and move lug **A** to its extreme left position.

Use a short stitch length and perfectly balanced tensions.

THE QUILTER

The Quilter, designed with a short, open foot and an adjustable and removable space guide, is especially well adapted to stitching lightly padded materials. The light padding is based to the underside of the fabric and may be of outing flannel, canton flannel, sheet wadding or light wool interlining.

Replace the presser foot with the Quilter. Adjust the space guide for the width between stitching lines. The space guide may be used to the right or left of the needle.

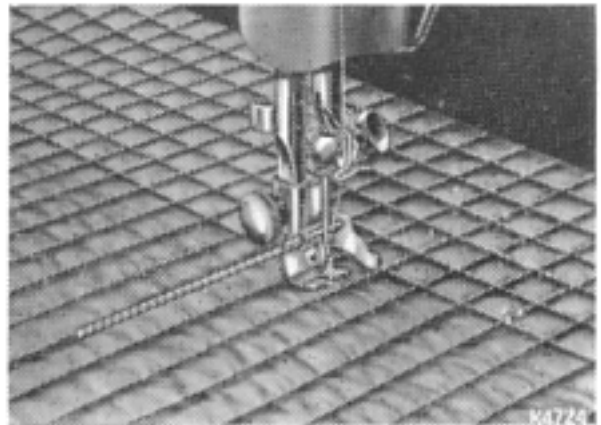

SINGER

Class 99 & 99K

THE ADJUSTABLE HEMMER

To make hems from $\frac{3}{16}$ to $\frac{15}{16}$ inch wide.

1. Attach adjustable hemmer to presser bar in place of presser foot.
2. Pull up bobbin thread as instructed on **page 18**.
3. Loosen thumb screw on hemmer and move scale until pointer registers with number of desired width of hem. (No. 1 indicates the narrowest hem and No. 8, the widest.) Then tighten thumb screw.
4. Place cloth in hemmer and draw it back and forth until hem is formed as shown.
5. Draw end of hem back under needle, lower presser bar and start to sew.
6. Guide sufficient cloth into hemmer to turn hem properly.

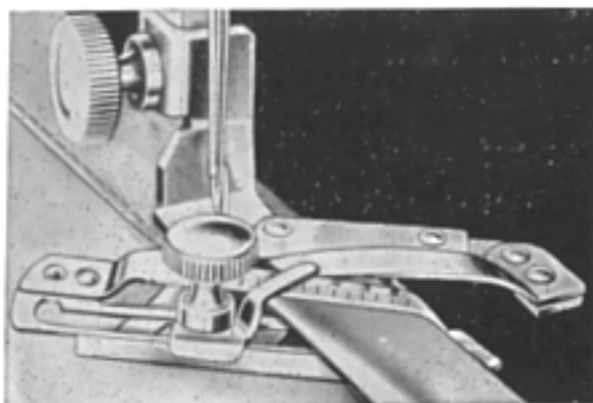

Wide Hemming

To make a hem more than $\frac{15}{16}$ inch wide, loosen thumb screw in hemmer and move scale to right as far as it will go, then swing it toward you as shown and tighten thumb screw. Fold and crease down a hem of the desired width, pass fold under extension at right of hemmer, and the edge into folder as shown and proceed to stitch the hem.

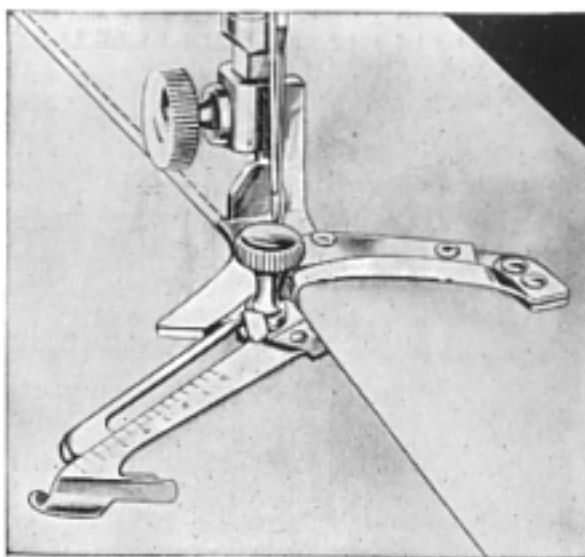

SINGER

Class 99 & 99K

THE TUCKER

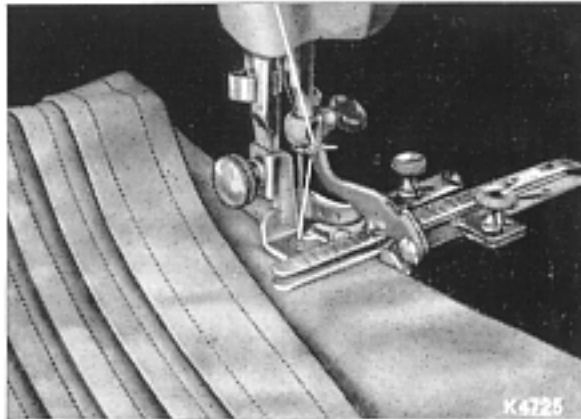

The Tucker is a time-saver for making tucks up to one inch in width. Two adjustable scales are provided, the smaller near the needle is numbered 1 to 8, expressing in eighths of an inch the width of the tuck. The larger scale expresses in quarter inches the spacing between tucks.

Set the tuck scale for the width of tuck. The space scale is then adjusted using the needle as an indicator for the spacing between tucks. When both scales are set at the same number, blind tucks result. That is, the fold of one tuck just touches the stitching line of the next. When additional space between tucks is desired, adjust the space scale to a point beyond the tuck scale reading equal to the spacing desired, expressed in quarters of an inch. Thus half-inch tucks spaced a half inch apart require a tuck scale setting of 4, and a space scale setting of 6.

SINGER

Class 99 & 99K

DARNING OR EMBROIDERING

While darning and embroidery can be done on the machine when threaded for regular sewing, the use of feed cover plate **Y**, No. 32622, is recommended, as movable contact with the feed in some cases might interfere with the handling of the work.

Don not change the adjustment of the feed dog in any way, as it is essential that its position should remain as originally fixed.

When the feed cover plate **Y** is used, it is necessary to lead the needle thread through the eye in the thread regulator **X** at the left of the tension discs and **not under the thread regulator**. With this exception, the threading is the same as for regular sewing (see **Fig. 14, page 13**).

Remove the presser foot and let down the presser bar lifter to restore the tension on the needle thread, which is released and inoperative when the lifter is raised.

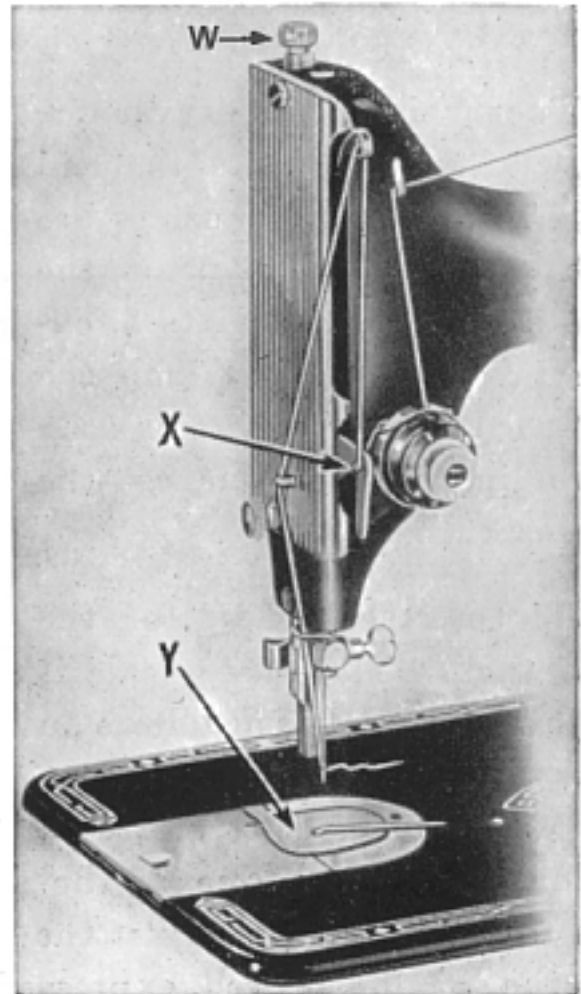

Machine Threaded for Darning and Embroidery

SINGER Class 99 & 99K

Darning or Embroidering (cont')

To attach the feed cover plate, draw to the left the slide that covers the bobbin case and insert the downwardly projecting hoods on the cover plate under the edge of the throat plate and push it to the right. After bringing the hole at the right of the cover plate in line with the hole in the throat plate, press the cover into position and close the slide

A feed cover plate is not included in the regular set of attachments, but is on sale at all SINGER Sewing Centers.

THE IMPORTANCE OF USING **SINGER** NEEDLES AND **SINGER** OIL FOR YOUR SEWING MACHINE

NEEDLES

You will obtain the best stitching results from your sewing machine if it is fitted with a SINGER needle.

SINGER needles and their containers are marked with the Company's Trademark SINGER or SIMANCO and can be purchased from any SINGER Sewing Center.

USE **SINGER** OIL ON MACHINE

Knowing from many years' experience the great importance of using good oil, SINGER sells an extra quality machine oil, especially prepared for sewing machines.

Free Manuals Download Website

<http://myh66.com>

<http://usermanuals.us>

<http://www.somanuals.com>

<http://www.4manuals.cc>

<http://www.manual-lib.com>

<http://www.404manual.com>

<http://www.luxmanual.com>

<http://aubethermostatmanual.com>

Golf course search by state

<http://golfingnear.com>

Email search by domain

<http://emailbydomain.com>

Auto manuals search

<http://auto.somanuals.com>

TV manuals search

<http://tv.somanuals.com>